

& Tradition

In Between ^{MTO}
Sami Kallio
2024

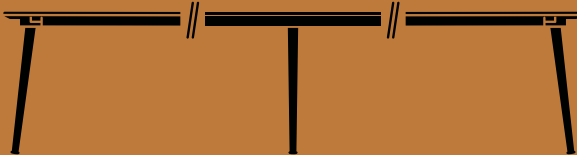

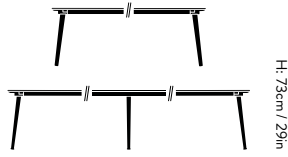

L: 90cm-500cm / 35in-197in
W: 90cm-230cm / 35in-47in

H: 73cm / 29in

In Between^{MTO} by Sami Kallio 2024

Product description

Dining table / Conference table

Environment

Indoor

Materials

Solid oak and oak veneer. This product has not been treated with any biocides.

Production process

The table top is made from oak veneer on the top and edges. The legs are made of solid wood while wood blocks are used to attach the legs to the table top.

Variants

Black Lacquered Oak, Clear Lacquered Oak, Smoked Lacquered Oak. Also available with Fenix Nano Laminate and Forbo Linoleum table top.

Dimensions

Available as made to order with 8 weeks lead time.

L: 301cm-500cm / 118in-197in

W: 90cm-230cm / 35in-47in

*please note that tabletops over 300cm in length are comprised of two tabletops and 6 legs

Round:

Ø: 60cm-150cm / 24in-59in

H: 73cm / 29in

Weight

Weight dependent on size ordered.

Strength, durability and safety testing

The table is tested for strength, durability and safety according to: EN (Contract Use)

Certifications



FSC® Mix 70% & EU Ecolabel

Gliders

Plastic gliders

Impact

- Made in a factory powered by certified renewable energy.
- Designed for disassembly, enabling easier repair, renovation and replacement of parts.
- Uses FSC® certified wood, supporting responsible management of the world's forests.

Manufacturer

Produced in Denmark by Kvist

Cleaning Instructions

[Please see our Maintenance & Care instructions here](#)



→ Black
Lacquered Oak



→ Clear
Lacquered Oak



→ Smoked
Lacquered Oak

Recycling & Disassembly

In Between^{MTO}

Recycling

The Ita dining table has been made to last and we hope it will serve you for many years. The table is made from wood and can be easily separated into its components and delivered to a suitable recycling depot.

Spare parts

To purchase spare parts for your Ita dining table, please write to our sales support team at sales@&Tradition.com with your query.

5 year warranty

&Tradition provides a 5-year warranty with every Ita dining table, which covers faults present at the time of purchase, or those which have occurred as a result of a manufacturing defect. The warranty is valid from the date stated on the original invoice.

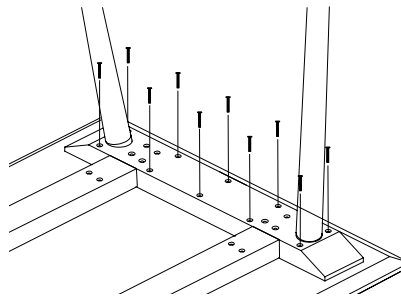

Disassembly

1. Unscrew the bolts in the aprons

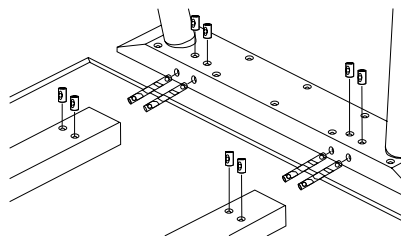

2. Loosen the set nuts in the aprons and the stretcher with an Allen key. Remove the apron from the stretcher. Remove the nuts and the metal dowels.

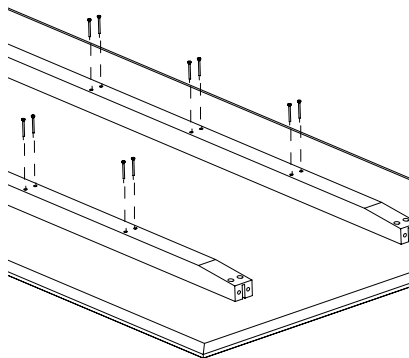

3. Unscrew the screws in the stretchers with a screwdriver.

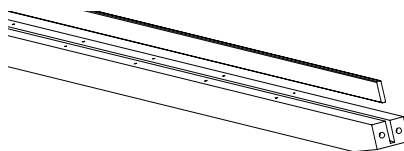

4. Remove the steel profile from the stretchers.

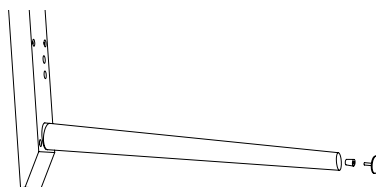

5. Unscrew the gliders in the legs. Unscrew the bushing in the legs with an Allen key.