

# & Tradition

Rombe <sup>IF1-IF6</sup>

Industrial Facility

2025

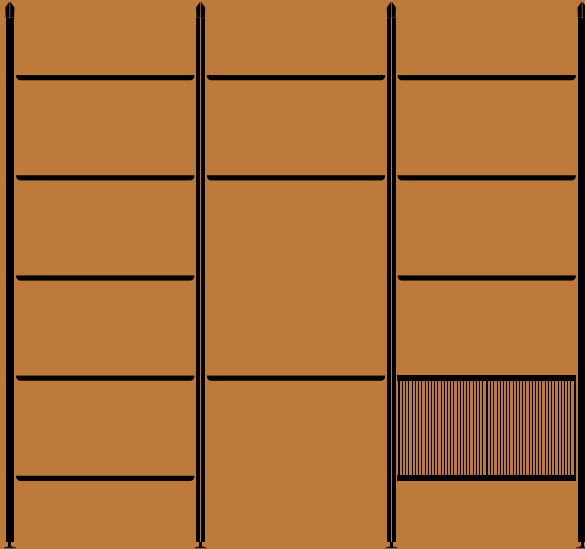



W: 83 cm / 32 5/8 in  
D: 36 cm / 14 1/8 in

H: 223 cm / 87 7/8 in

# Rombe <sup>IF1</sup> Industrial Facility 2025

## Product description

Single bay shelves

## Environment

Indoor

## Material

Water-based lacquered oak or walnut veneer, wood-based board and / or powder-coated steel and aluminium. This product has not been treated with any biocides.

## Production process

Die-cast aluminium top support and foot. Extruded aluminium upright bracket. Laser cut and bent sheet steel shelves, or wooden shelves made from a wood-based board and oak veneer.

## Dimensions

H: 223 cm / 87 7/8 in  
W: 83 cm / 32 5/8 in  
D: 36 cm / 14 1/8 in

## Weight

Veneer: 28 kg, Steel: 30.3 kg

## Strength, durability and safety testing

EN Level 2 - Storage  
BIFMA

## Certifications



FSC® Mix 70%

## Add-ons

Rombe IF4 - Half bay, shelves  
Rombe IF5 - Half bay, desk  
Rombe IF6 - Half bay, cabinet

## Impact

- Made using FSC® certified wood, supporting responsible management of the world's forests.
- Uses water-based lacquer, safer for indoor air quality.
- Designed for disassembly, making it easier to repair, renovate and responsibly recycle at end-of-life.
- Uses aluminium, a lightweight, durable and highly recyclable metal, able to be repurposed in another production cycle.
- Packaging uses FSC® certified cardboard, supporting responsible management of the world's forests."

## Manufacturer

Produced in PRC by Nine United China Limited

## Cleaning Instructions

Please see our [Maintenance & Care instructions here](#)

## → Stock items

Available in stock

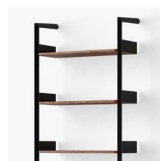

→ Anthracite  
& Walnut



→ Anthracite



→ Alabaster  
& Oak



→ Alabaster

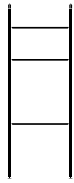

H: 223 cm / 87 7/8 in

W: 83 cm / 32 5/8 in  
D: 36 cm / 14 1/8 in  
Desk D: 49 cm / 19 1/4 in

# Rombe<sup>IF2</sup> Industrial Facility 2025

## Product description

Single bay desk

## Environment

Indoor

## Material

Water-based lacquered oak or walnut veneer, wood-based board and / or powder-coated steel and aluminium. This product has not been treated with any biocides.

## Production process

Die-cast aluminium top support and foot. Extruded aluminium upright bracket. Laser cut and bent sheet steel shelves, or wooden shelves made from a wood-based board and oak veneer. Desk made from a wood-based board and oak or walnut veneer.

## Dimensions

H: 223 cm / 87 7/8 in  
W: 83 cm / 32 5/8 in  
D: 36 cm / 14 1/8 in  
Desk D: 49 cm / 19 1/4 in

## Weight

Veneer: 21 kg  
Steel: 22 kg

## Strength, durability and safety testing

EN Level 2 - Storage  
BIFMA

## Certifications



FSC® Mix 70%

## Add-ons

Rombe IF4 - Half bay, shelves  
Rombe IF5 - Half bay, desk  
Rombe IF6 - Half bay, cabinet

## Impact

- Made using FSC® certified wood, supporting responsible management of the world's forests.
- Uses water-based lacquer, safer for indoor air quality.
- Designed for disassembly, making it easier to repair, renovate and responsibly recycle at end-of-life.
- Uses aluminium, a lightweight, durable and highly recyclable metal, able to be repurposed in another production cycle.
- Packaging uses FSC® certified cardboard, supporting responsible management of the world's forests.

## Manufacturer

Produced in PRC by Nine United China Limited

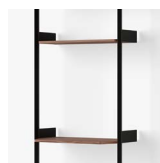

→ Anthracite  
& Walnut



→ Anthracite



→ Alabaster  
& Oak



→ Alabaster

## Cleaning Instructions

Please see our [Maintenance & Care instructions here](#)

## → Stock items

Available in stock

&Tradition®

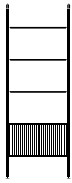

W: 83 cm / 32 5/8 in  
D: 36 cm / 14 1/8 in

H: 223 cm / 87 7/8 in

# Rombe <sup>IF3</sup> Industrial Facility 2025

## Product description

Single bay cabinet

## Environment

Indoor

## Material

Water-based lacquered oak or walnut veneer, wood-based board and / or powder-coated steel, aluminium & 5mm low iron, reeded glass. This product has not been treated with any biocides.

## Production process

Die-cast aluminium top support and foot. Extruded aluminium upright bracket. Laser cut and bent sheet steel shelves, or wooden shelves made from a wood-based board and oak or walnut veneer. Cabinet made from wood-based board and oak or walnut veneer with reeded glass cabinet doors.

## Dimensions

H: 223 cm / 87 7/8 in  
W: 83 cm / 32 5/8 in  
D: 36 cm / 14 1/8 in

## Weight

Veneer: 46 kg  
Steel: 48 kg

## Strength, durability and safety testing

EN Level 2 - Storage  
BIFMA

## Certifications



FSC® Mix 70%

## Add-ons

Rombe IF4 - Half bay, shelves  
Rombe IF5 - Half bay, desk  
Rombe IF6 - Half bay, cabinet  
Powder coated steel shelf

## Impact

- Made using FSC® certified wood, supporting responsible management of the world's forests.
- Uses water-based lacquer, safer for indoor air quality.
- Designed for disassembly, making it easier to repair, renovate and responsibly recycle at end-of-life.
- Uses aluminium, a lightweight, durable and highly recyclable metal, able to be repurposed in another production cycle.
- Packaging uses FSC® certified cardboard, supporting responsible management of the world's forests.

## Manufacturer

Produced in PRC by Nine United China Limited



→ Anthracite  
& Walnut



→ Anthracite



→ Alabaster  
& Oak



→ Alabaster

## Cleaning Instructions

Please see our [Maintenance & Care instructions here](#)

## → Stock items

Available in stock

&Tradition®

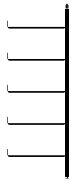

H: 223 cm / 87 7/8 in

W: 81.5 cm / 32 in  
D: 36 cm / 14 1/8 in

# Rombe IF4 Industrial Facility 2025

## Product description

Add-on bay shelves

## Environment

Indoor

## Material

Water-based lacquered oak or walnut veneer, wood-based board and / or powder-coated steel and aluminium. This product has not been treated with any biocides.

## Production process

Die-cast aluminium top support and foot. Extruded aluminium upright bracket. Laser cut and bent sheet steel shelves, or wooden shelves made from a wood-based board and oak veneer.

## Dimensions

H: 223 cm / 87 7/8 in  
W: 81.5 cm / 32 in  
D: 36 cm / 14 1/8 in

## Weight

Veneer: 25 kg, Steel: 27 kg

## Strength, durability and safety testing

EN Level 2 - Storage  
BIFMA

## Certifications



FSC® Mix 70%

## Add-ons

IF1:  
Rombe IF4 - Half bay, shelves  
Rombe IF5 - Half bay, desk  
Rombe IF6 - Half bay, cabinet

## Impact

- Made using FSC® certified wood, supporting responsible management of the world's forests.
- Uses water-based lacquer, safer for indoor air quality.
- Designed for disassembly, making it easier to repair, renovate and responsibly recycle at end-of-life.
- Uses aluminium, a lightweight, durable and highly recyclable metal, able to be repurposed in another production cycle.
- Packaging uses FSC® certified cardboard, supporting responsible management of the world's forests.

## Manufacturer

Produced in PRC by Nine United China Limited

## Cleaning Instructions

Please see our [Maintenance & Care instructions here](#)

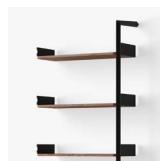

→ Anthracite  
& Walnut



→ Anthracite

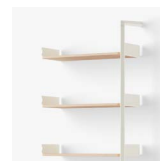

→ Alabaster  
& Oak

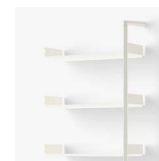

→ Alabaster

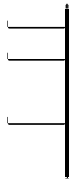

H: 223 cm / 87 7/8 in

W: 81.5 cm / 32 in  
D: 36 cm / 14 1/8 in  
Desk D: 49 cm / 19 1/4 in

# Rombe<sup>IF5</sup> Industrial Facility 2025

## Product description

Add-on bay desk

## Environment

Indoor

## Material

Water-based lacquered oak or walnut veneer, wood-based board and / or powder-coated steel and aluminium. This product has not been treated with any biocides.

## Production process

Die-cast aluminium top support and foot. Extruded aluminium upright bracket. Lazer cut and bent sheet steel shelves, or wooden shelves made from a wood-based board and oak veneer. Desk made from a wood-based board and oak or walnut veneer.

## Dimensions

H: 223 cm / 87 7/8 in  
W: 81.5 cm / 32 in  
D: 36 cm / 14 1/8 in  
Desk D: 49 cm / 19 1/4 in

## Weight

Veneer: 18 kg  
Steel: 19 kg

## Strength, durability and safety testing

## Certifications



FSC® Mix 70%

## Impact

- Made using FSC® certified wood, supporting responsible management of the world's forests.
- Uses water-based lacquer, safer for indoor air quality.
- Designed for disassembly, making it easier to repair, renovate and responsibly recycle at end-of-life.
- Uses aluminium, a lightweight, durable and highly recyclable metal, able to be repurposed in another production cycle.
- Packaging uses FSC® certified cardboard, supporting responsible management of the world's forests.

## Manufacturer

Produced in PRC by Nine United China Limited

## Cleaning Instructions

Please see our [Maintenance & Care instructions here](#)

## → Stock items

Available in stock



→ Anthracite  
& Walnut



→ Anthracite



→ Alabaster  
& Oak



→ Alabaster

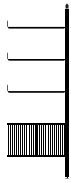

W: 81.5 cm / 32 in  
D: 36 cm / 14 1/8 in

H: 223 cm / 87 7/8 in

# Rombe<sup>IF6</sup>

## Industrial Facility

### 2025

#### Product description

Add-on bay cabinet

#### Environment

Indoor

#### Material

Water-based lacquered oak or walnut veneer, wood-based board and / or powder-coated steel, aluminium & 5mm low iron, reeded glass. This product has not been treated with any biocides.

#### Production process

Die-cast aluminium top support and foot. Extruded aluminium upright bracket. Laser cut and bent sheet steel shelves, or wooden shelves made from a wood-based board and oak or walnut veneer. Cabinet made from wood-based board and oak or walnut veneer with reeded glass cabinet doors.

#### Dimensions

H: 223 cm / 87 7/8 in  
W: 81.5 cm / 32 in  
D: 36 cm / 14 1/8 in

#### Weight

Veneer: 43 kg, Steel: 45 kg

#### Strength, durability and safety testing

#### Certifications



FSC® Mix 70%

#### Add-ons

Powder coated steel shelf

#### Impact

- Made using FSC® certified wood, supporting responsible management of the world's forests.
- Uses water-based lacquer, safer for indoor air quality.
- Designed for disassembly, making it easier to repair, renovate and responsibly recycle at end-of-life.
- Uses aluminium, a lightweight, durable and highly recyclable metal, able to be repurposed in another production cycle.
- Packaging uses FSC® certified cardboard, supporting responsible management of the world's forests.

#### Manufacturer

Produced in PRC by Nine United China Limited

#### Cleaning Instructions

[Please see our Maintenance & Care instructions here](#)

#### → Stock items

Available in stock

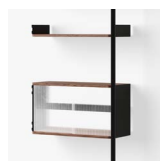

→ Anthracite & Walnut



→ Anthracite



→ Alabaster & Oak

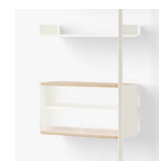

→ Alabaster

# Recycling & Disassembly

Rombe <sup>IF1-IF3</sup>

---

## Recycling

Your Rombe shelving system is built to last and we hope that it will serve you for many years to come. Made from a combination of solid wood, wood veneer, powder-coated steel and aluminium elements, the system can be easily separated and delivered to a suitable recycling station.

## Spare parts

To purchase spare parts, please write to our sales support team at \_\_\_\_\_ with your query.

## 5 year warranty

&Tradition provides a 5-year warranty with every Rombe system. This warranty covers any faults present at the time of purchase, or those that may have occurred as a result of a manufacturing defect. The warranty is valid from the date stated on the original invoice.

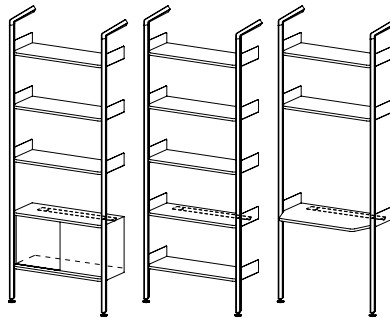

## Disassembly

1. First, locate any bracket connecting the shelving system to the wall. Remove the screws holding it into place and separate it from the shelf.

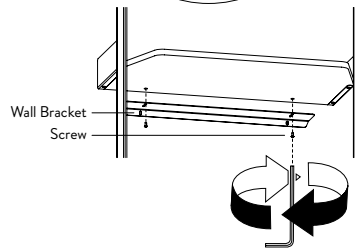
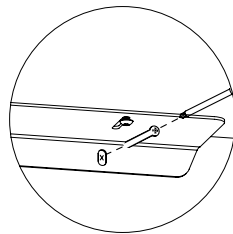

# Recycling & Disassembly

Rombe IF1-IF3

---

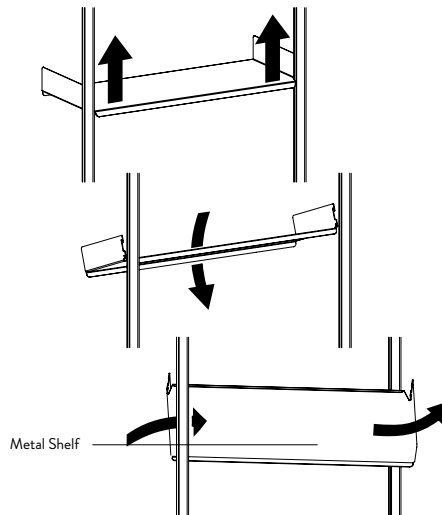

## Disassembly

2. Next, remove metal shelves from the system as illustrated.

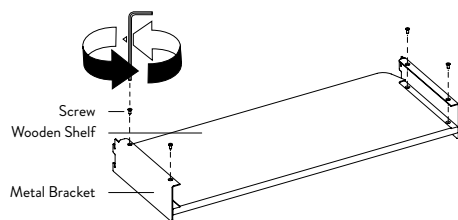

3. In the case of wooden desks or shelves, separate the metal brackets from either end by removing the screws from underneath. Remember to also remove the threaded inserts from the wooden boards.

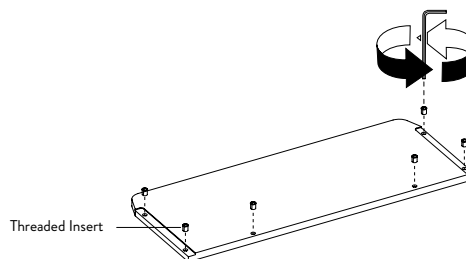

# Recycling & Disassembly

Rombe IF1-IF3

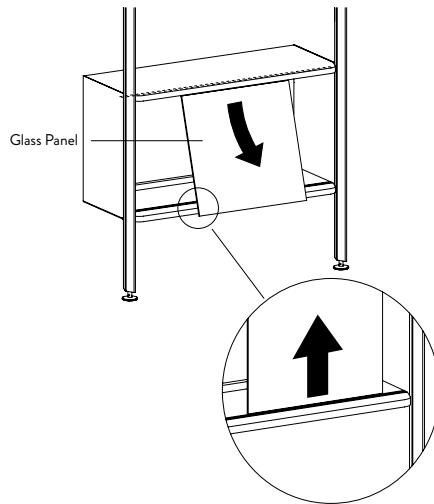

## Disassembly

4. To disassemble the cabinet, carefully remove the glass panels first. Start by gently lifting the glass panel all the way up into the top rail.

Next, remove the panel from the bottom edge as illustrated.

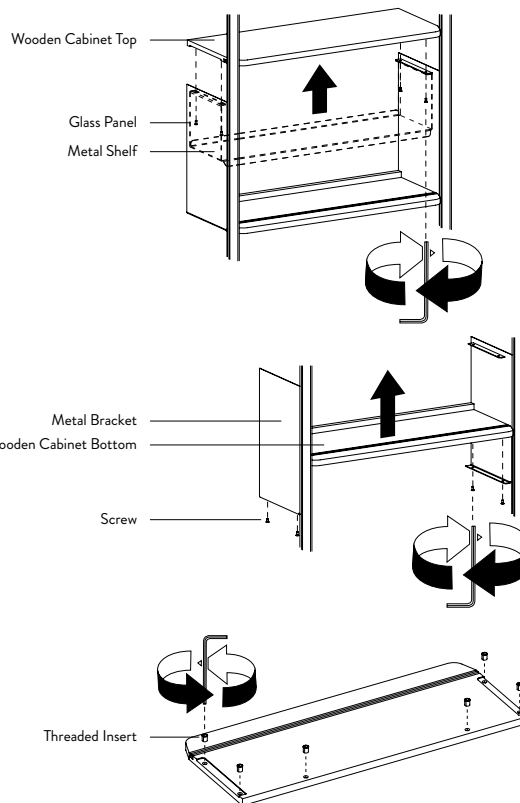

5. Unscrew the wooden cabinet top by removing the screws on the underside. In case there is a metal cabinet shelf, separate this as well.

6. Continue to remove the wooden cabinet bottom next.

7. Remember to remove the threaded inserts from the wooden boards.

# Recycling & Disassembly

Rombe IF1-IF3

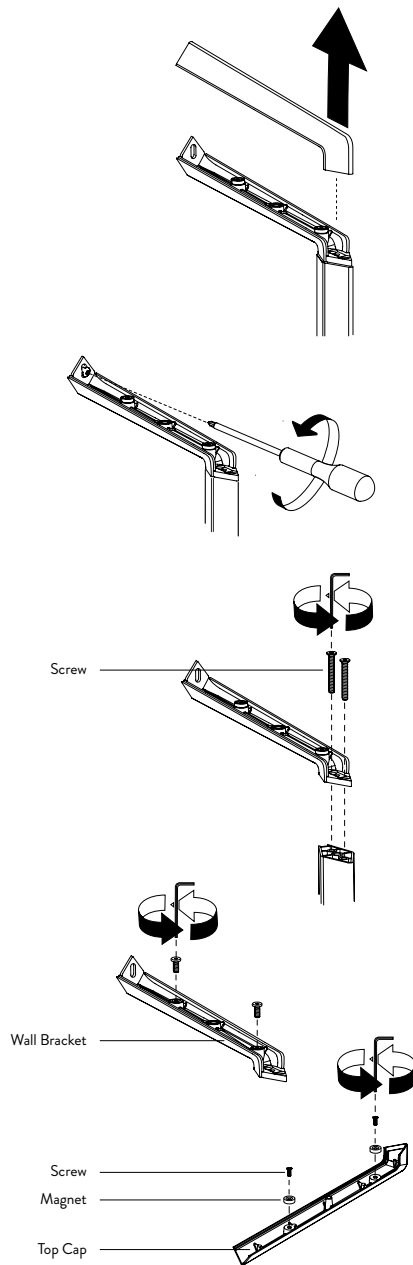

## Disassembly

8. Next, lift the top cap from the wall brackets.

9. Detach the wall brackets from the wall by removing the screw holding them in place.

10. Separate the uprights from the wall brackets by removing the screws joining the two together.

11. Next, remove the screws and the magnets from both the uprights and the top caps.

# Recycling & Disassembly

Rombe IF1-IF3

---

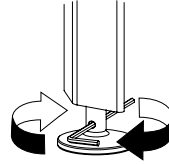

## Disassembly

12. Finally, remove the glider from the base of the uprights by unscrewing them counter clockwise.

Separate each glider into its individual parts by unscrewing the insert screw and the screw from below.

