

**VOLKER HAUG Studio**

**STEP & KICK series Data Sheet**

## Cross Kick High

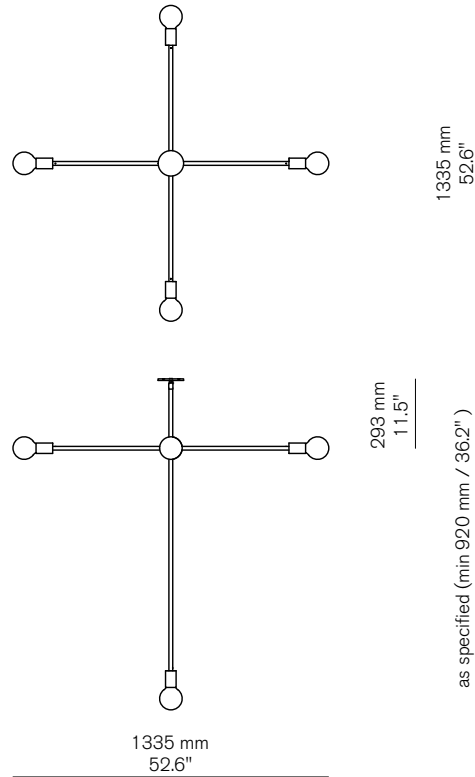

### Material

Brass

### Finishes

Brushed, Aged, Bronzed, Polished or Plated

### Lamp

ø 95 mm Opal

### Weight

approx 4.5kg

### US / Canada

Lamp: 5x 120V E26 Opal LED \*

Lamp Specs: 2700K, 8W, 750 lm

Dimming: Trailing Edge\*\*

### AU / EU / UK

Lamp: 5x 240V E27 Opal LED \*

Lamp Specs: 2700K, 8W, 800 lm

Dimming: Trailing Edge\*\*

\* 12V variation available

\*\* DALI and 0/1-10V dimming optional



## Cross Kick Low

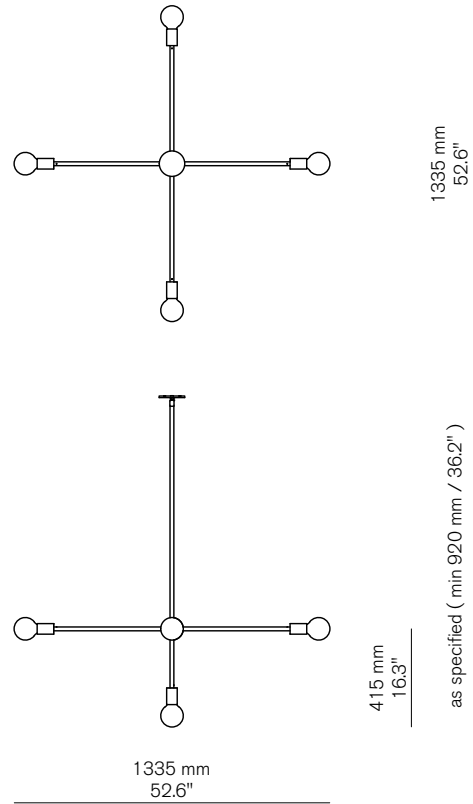

### Material

Brass

### Finishes

Brushed, Aged, Bronzed, Polished or Plated

### Lamp

ø 95 mm Opal

### Weight

approx 4.5kg

### US / Canada

Lamp: 5x 120V E26 Opal LED \*

Lamp Specs: 2700K, 8W, 750 lm

Dimming: Trailing Edge\*\*

### AU / EU / UK

Lamp: 5x 240V E27 Opal LED \*

Lamp Specs: 2700K, 8W, 800 lm

Dimming: Trailing Edge\*\*

\* 12V variation available

\*\* DALI and 0/1-10V dimming optional



# Big Kick

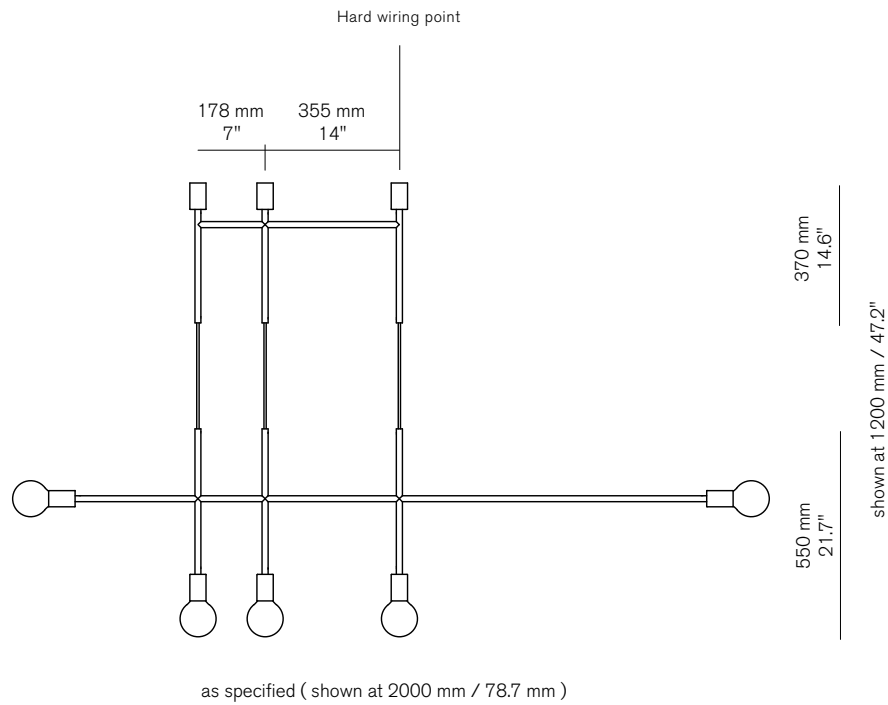

## Material

Brass

## Finishes

Brushed, Aged, Bronzed, Polished or Plated

## Lamp

ø 95 mm Opal

## Weight

approx 4.5kg

## US / Canada

Lamp: 5x 120V E26 Opal LED \*

Lamp Specs: 2700K, 8W, 750 lm

Dimming: Trailing Edge\*\*

## AU / EU / UK

Lamp: 5x 240V E27 Opal LED \*

Lamp Specs: 2700K, 8W, 800 lm

Dimming: Trailing Edge\*\*

\* 12V variation available

\*\* DALI and 0/1-10V dimming optional



# Big Kick Solid

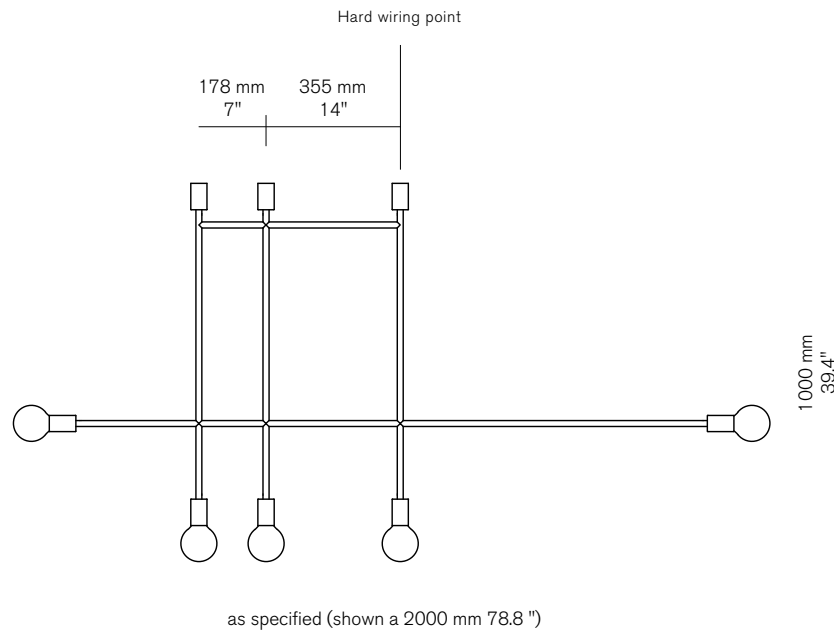

## Material

Brass

## Finishes

Brushed, Aged, Bronzed, Polished or Plated

## Lamp

ø 95 mm Opal

## Weight

approx 4.5kg

## US / Canada

Lamp: 5x 120V E26 Opal LED \*

Lamp Specs: 2700K, 8W, 750 lm

Dimming: Trailing Edge\*\*

## AU / EU / UK

Lamp: 5x 240V E27 Opal LED \*

Lamp Specs: 2700K, 8W, 800 lm

Dimming: Trailing Edge\*\*

\* 12V variation available

\*\* DALI and 0/1-10V dimming optional



## Big Kick Solid (with j-box cover plate)

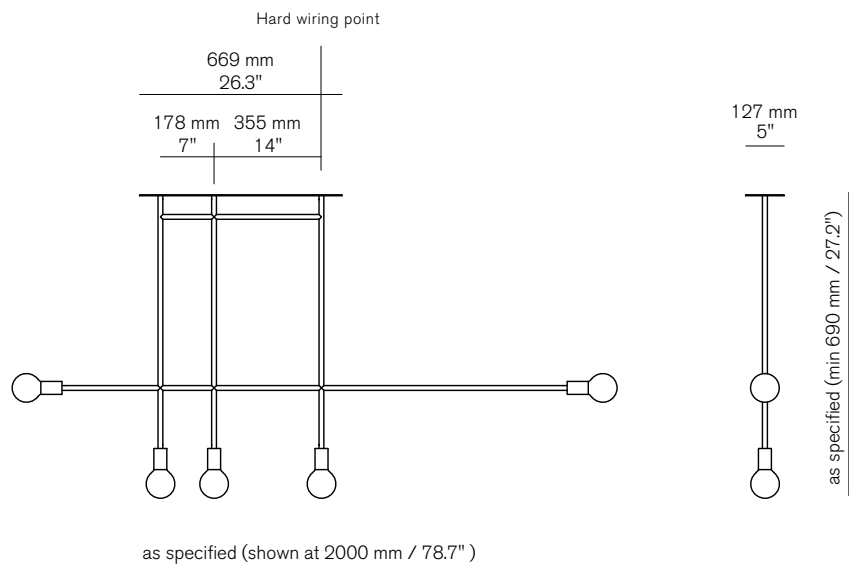

### Material

Brass

### Finishes

Brushed, Aged, Bronzed, Polished or Plated

### Lamp

ø 95 mm Opal

### Weight

approx 4.5kg

### US / Canada

Lamp: 5x 120V E26 Opal LED \*

Lamp Specs: 2700K, 8W, 750 lm

Dimming: Trailing Edge\*\*

\* 12V variation available

\*\* DALI and 0/1-10V dimming optional



# Triple Kick

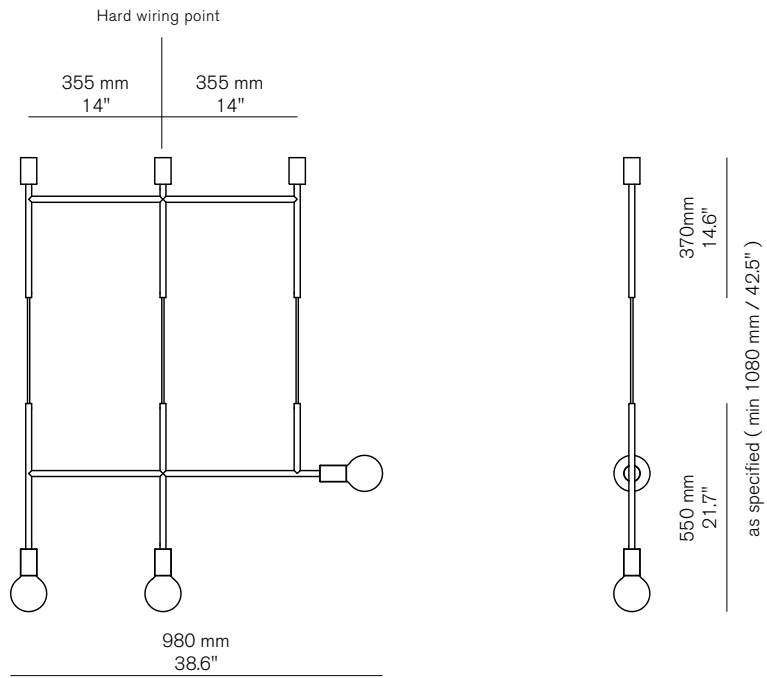

## Material

Brass

## Finishes

Brushed, Aged, Bronzed, Polished or Plated

## Lamp

ø 95 mm Opal

## Weight

approx 3.5kg

## US / Canada

Lamp: 3x 120V E26 Opal LED \*

Lamp Specs: 2700K, 8W, 750 lm

Dimming: Trailing Edge\*\*

## AU / EU / UK

Lamp: 3x 240V E27 Opal LED \*

Lamp Specs: 2700K, 8W, 800 lm

Dimming: Trailing Edge\*\*

\* 12V variation available

\*\* DALI and 0/1-10V dimming optional

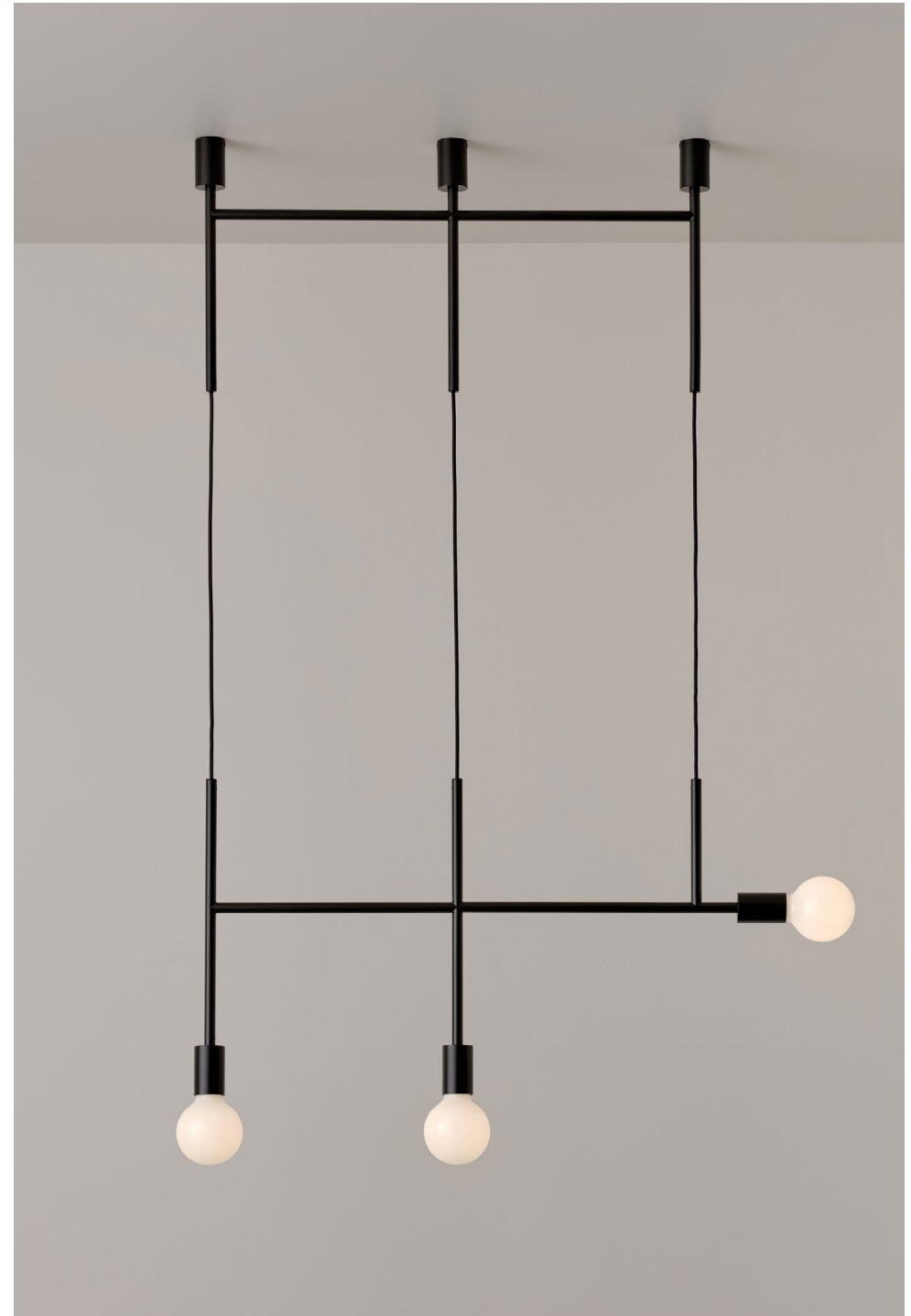

# Triple Step

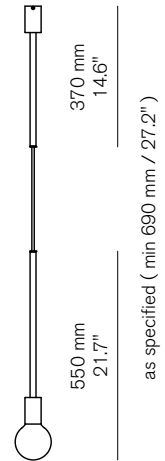
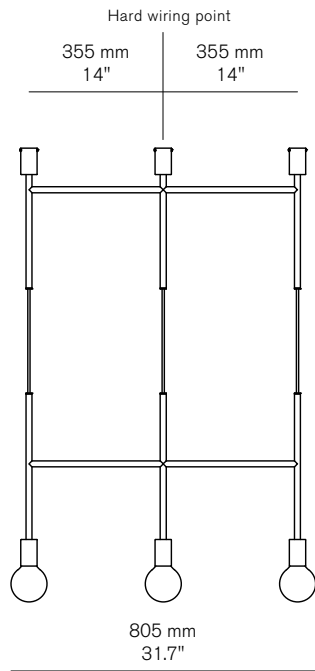

## Material

Brass

## Finishes

Brushed, Aged, Bronzed, Polished or Plated

## Lamp

ø 95 mm Opal

## Weight

approx 3.5kg

## US / Canada

Lamp: 3x 120V E26 Opal LED \*  
Lamp Specs: 2700K, 8W, 750 lm  
Dimming: Trailing Edge\*\*

## AU / EU / UK

Lamp: 3x 240V E27 Opal LED \*  
Lamp Specs: 2700K, 8W, 800 lm  
Dimming: Trailing Edge\*\*

\* 12V variation available

\*\* DALI and 0/1-10V dimming optional



## Side Kick

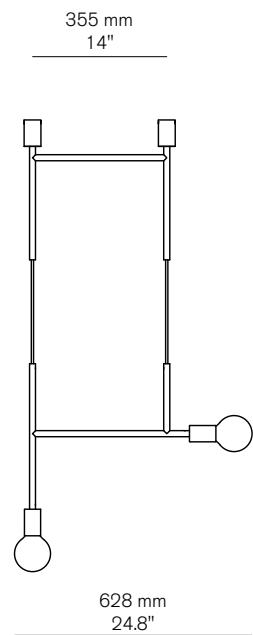

### Material

Brass

### Finishes

Brushed, Aged, Bronzed, Polished or Plated

### Lamp

ø 95 mm Opal

### Weight

approx 2.3kg

### US / Canada

Lamp: 120V E26 Opal LED \*

Specs: 2700K, 8W, 750 lm

Dimming: Trailing Edge\*\*

### AU / EU / UK

Lamp: 240V E27 Opal LED \*

Specs: 2700K, 8W, 800 lm

Dimming: Trailing Edge\*\*

\* 12V variation available

\*\* DALI and 0/1-10V dimming optional



## Side Step

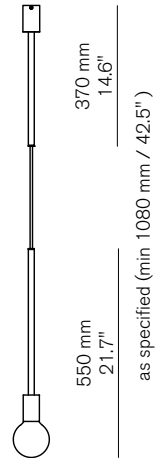
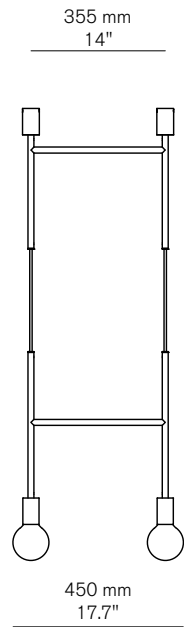

### Material

Brass

### Finishes

Brushed, Aged, Bronzed, Polished or Plated

### Lamp

ø 95 mm Opal

### Weight

approx 2.3kg

### US / Canada

Lamp: 120V E26 Opal LED \*

Specs: 2700K, 8W, 750 lm

Dimming: Trailing Edge\*\*

### AU / EU / UK

Lamp: 240V E27 Opal LED \*

Specs: 2700K, 8W, 800 lm

Dimming: Trailing Edge\*\*

\* 12V variation available

\*\* DALI and 0/1-10V dimming optional



## Side Step Solid

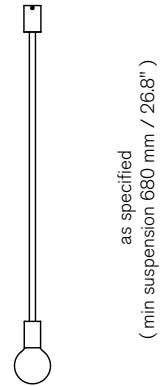
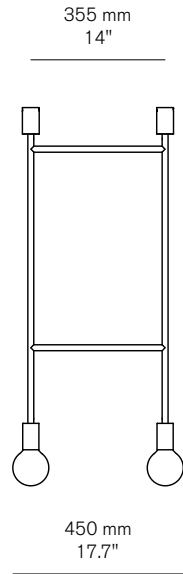

### Material

Brass

### Finishes

Brushed, Aged, Bronzed, Polished or Plated

### Lamp

ø 95 mm Opal

### Weight

approx 3kg

### US / Canada

Lamp: 120V E26 Opal LED \*

Specs: 2700K, 8W, 750 lm

Dimming: Trailing Edge\*\*

### AU / EU / UK

Lamp: 240V E27 Opal LED \*

Specs: 2700K, 8W, 800 lm

Dimming: Trailing Edge\*\*

\* 12V variation available

\*\* DALI and 0/1-10V dimming optional



## Wide Step

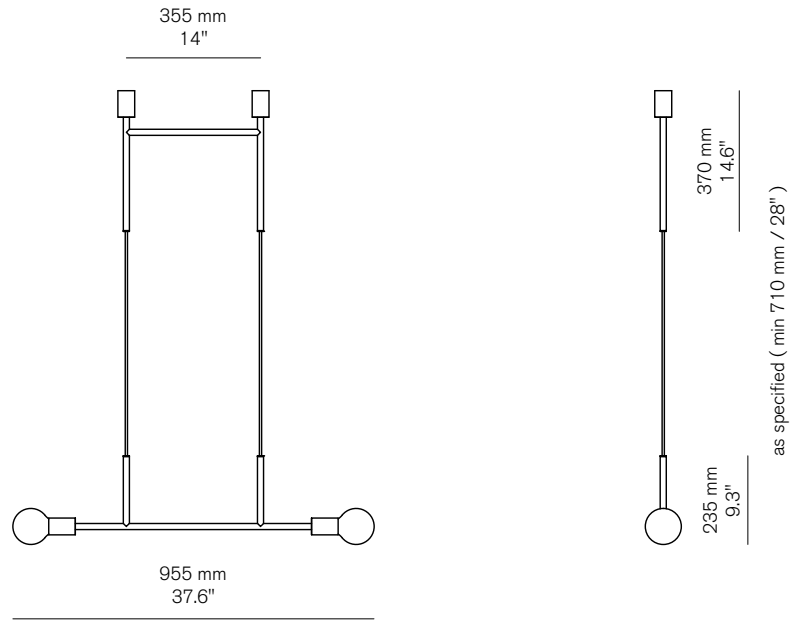

### Material

Brass

### Finishes

Brushed, Aged, Bronzed, Polished or Plated

### Lamp

ø 95 mm Opal

### Weight

approx 2.5kg

### US / Canada

Lamp: 120V E26 Opal LED \*

Specs: 2700K, 8W, 750 lm

Dimming: Trailing Edge\*\*

### AU / EU / UK

Lamp: 240V E27 Opal LED \*

Specs: 2700K, 8W, 800 lm

Dimming: Trailing Edge\*\*

\* 12V variation available

\*\* DALI and 0/1-10V dimming optional

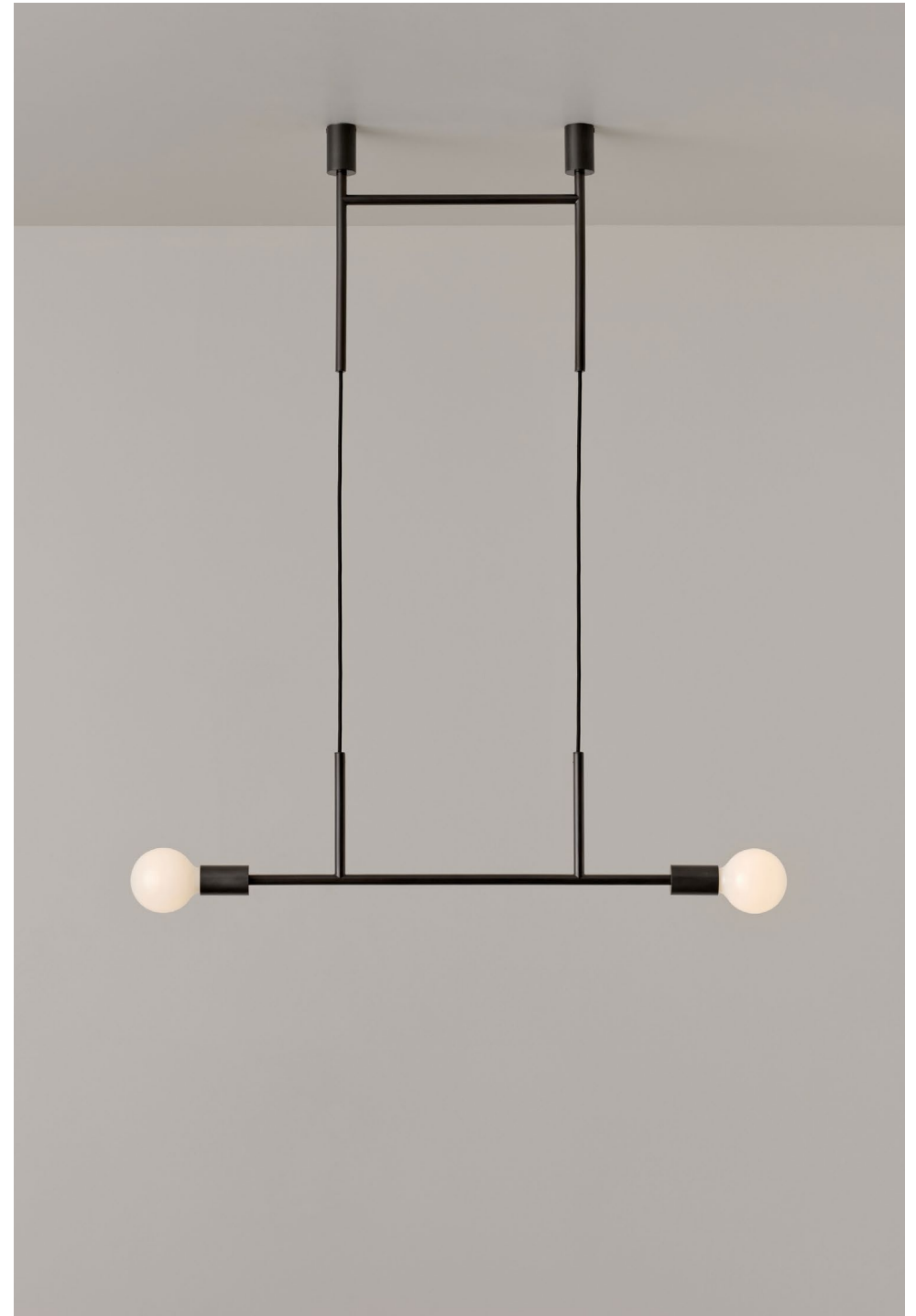

## Sole Step

Ø44 mm  
1.7"

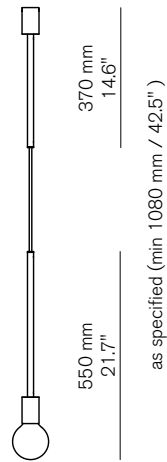

### Material

Brass

### Finishes

Brushed, Aged, Bronzed, Polished or Plated

### Lamp

ø 95 mm Opal

### Weight

approx 1 kg

### US / Canada

Lamp: 120V E26 Opal LED \*

Specs: 2700K, 8W, 750 lm

Dimming: Trailing Edge\*\*

### AU / EU / UK

Lamp: 240V E27 Opal LED \*

Specs: 2700K, 8W, 800 lm

Dimming: Trailing Edge\*\*

\* 12V variation available

\*\* DALI and 0/1-10V dimming optional



# Wall Step

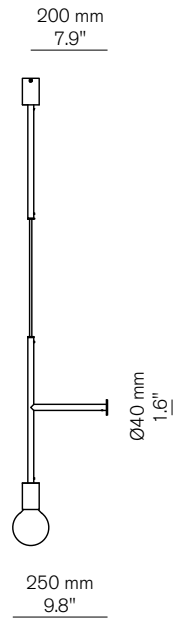
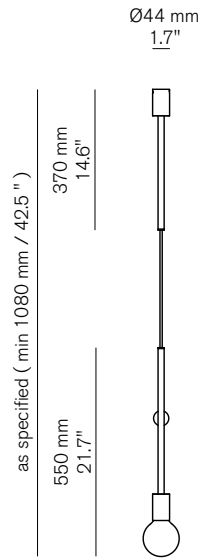

## Material

Brass

## Finishes

Brushed, Aged, Bronzed, Polished or Plated

## Lamp

ø 95 mm Opal

## Weight

approx 1.2kg

## US / Canada

Lamp: 120V E26 Opal LED \*

Specs: 2700K, 8W, 750 lm

Dimming: Trailing Edge\*\*

## AU / EU / UK

Lamp: 240V E27 Opal LED \*

Specs: 2700K, 8W, 800 lm

Dimming: Trailing Edge\*\*

\* 12V variation available

\*\* DALI and 0/1-10V dimming optional



## Wall Powered Wall Step

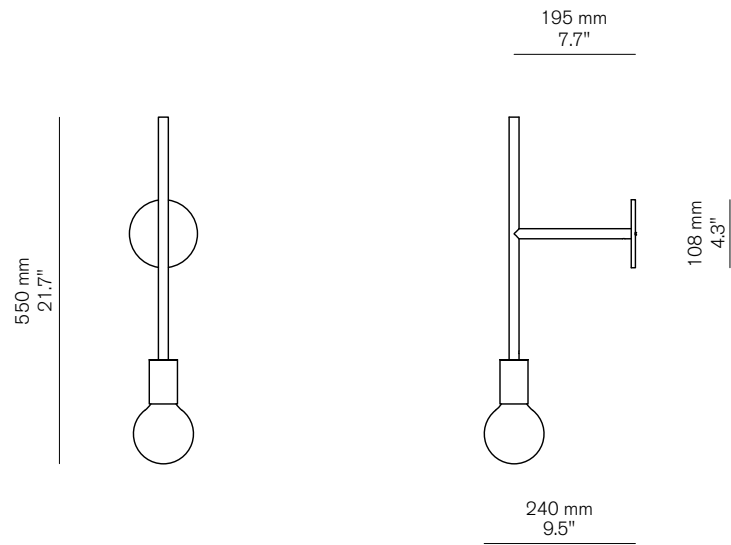

### Material

Brass

### Finishes

Brushed, Aged, Bronzed, Polished or Plated

### Lamp

ø 95 mm Opal

### Weight

approx 1 kg

### US / Canada

Lamp: 120V E26 Opal LED \*

Specs: 2700K, 8W, 750 lm

Dimming: Trailing Edge\*\*

### AU / EU / UK

Lamp: 240V E27 Opal LED \*

Specs: 2700K, 8W, 800 lm

Dimming: Trailing Edge\*\*

\* 12V variation available

\*\* DALI and 0/1-10V dimming optional





Lamps included. Full product range  
in the Volker Haug Studio Catalogue.  
Please contact studio for additional  
information on custom lengths,  
arrangements and finishes.

Volker Haug Studio  
2-12 St Phillip Street  
Brunswick East  
Melbourne VIC 3057 Australia

Phone  
Email