

LED Linear High Bay

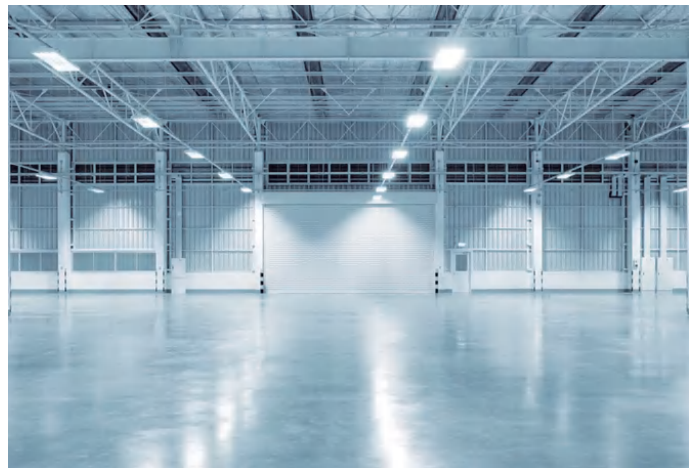

The Linear High Bay with its all-in-one, high quality lampshad with multiple mounting situations available put it at the top of the list for any high ceiling area where super bright light is needed. The LED Linear High bay Light Series can be widely used for indoor excellent for warehouse, industry building, factories, fitness center, and many other applications. Lighting controls meet design lights consortium (DLC) networked lighting control system technical requirements, LLLC, Energy Monitoring and High End Trim function.



Catalog Number	Description	Angle	Lumens	Watts	CCT	Voltage
SZ-LHB165W-2FT-ACP	LED Linear Hight Bay	90°	23100 Lm	Adjustable 90W/120W/165W	Adjustable 4000K/5000K/6000K	120V - 277V Optional 120-347V
SZ-LHB300WM-4FT-ACP	LED Linear Hight Bay	90°	42000 Lm	Adjustable 165W/225W/300W	Adjustable 4000K/5000K/6000K	120V - 277V Optional 120-347V
SZ-LHB500W-4FT-ACP	LED Linear Hight Bay	90°	70000 Lm	Adjustable 300W/400W/500W	Adjustable 4000K/5000K/6000K	120V - 277V Optional 120-347V

ORDERING GUIDE

Example: SZ-LHB300WM-4FT-ACP

Company Code	Fixture Type	Wattage	Size	Voltage	ACP
<input type="text"/>	<input type="text"/>	<input type="text"/>	<input type="text"/>	<input type="text"/>	<input type="text"/>
SZ Company Name	LS LED Linear High bay	165W 300W 500W	2FT 4FT	Blank 120-277V MV 120-347V	ACP Adjustable CCT and Power 165W:90/120/165W 4000K/5000K/6000K 300W:165/225/300W 4000K/5000K/6000K 500W:300/400/500W 4000K/5000K/6000K

LED Linear High Bay

Specifications

Housing

IRON+PMMA.

Electrical

Standard 120V - 277V, Optional 120-347V
0-10V dimming standard with a dimming range of
100%to 10%. PF > 0.9.

CCT and CRI

Adjustable 4000K/5000K/6000K. CRI 80.

Angle

90°

Operating Temperature

Suitable for use in -00° C to 50° C (-40° F to 113° F).

Efficacy

Up to 140 lumens per watt.

Certifications

ETL or UL Listed. DLC5.1

WARRANTY

5 Years Limited Warranty.

Dimension:

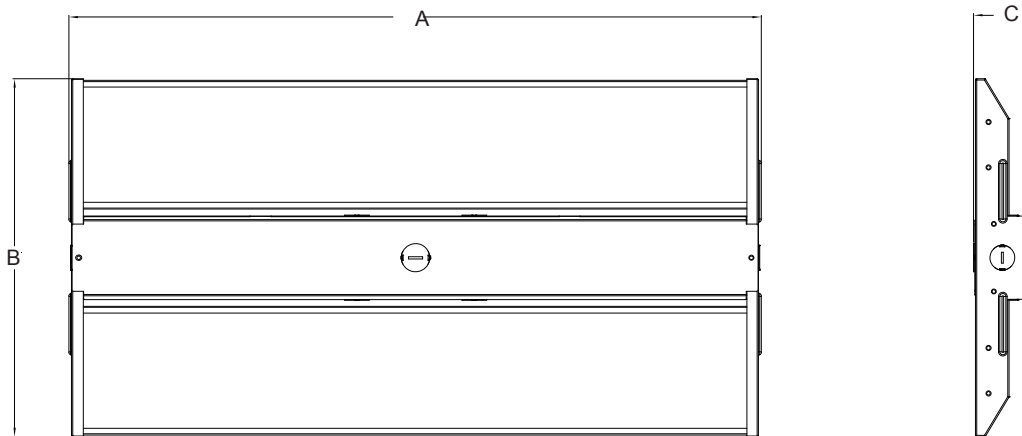

Specification	Power	A	B	C
2FT	165W	626mm/24.6"	323mm/12.8"	51mm/2"
4FT	300W	1166mm/45.9"	323mm/12.8"	51mm/2"
4FT	500W	1160mm/45.67"	323mm/12.8"	55mm/2.08"

Packing/Weight :

Catalog Number	Outer box (L*W*H)	Qty/CTN (pcs)	N.W./pcs (lbs/kg)	G.W./CTN (lbs/kg)	Remark
SZ-LHB165W-2FT-ACP	26.02*14.17*9.92" 661*360*252mm	4	23.76/10.8	26.62/12.1	
SZ-LHB300WM-4FT-ACP	47.83*14.69*5.35" 1215*373*136mm	2	27.28/12.4	31.46/14.3	
SZ-LHB500W-4FT-ACP	47*13.98*5.31" 1194*355*135mm	2	21.12/9.06	24.2/11	

LED Linear High Bay

CCT&Wattage selectable



Accessories (Optional)



Microwave Motion Sensor



Emergency driver

INSTRUCTIONS

WARNING!

READ CAREFULLY BEFORE INSTALLING FIXTURE. RETAIN THESE INSTRUCTIONS FOR FUTURE REFERENCE.

- TO AVOID ELECTRIC SHOCK OR COMPONENT DAMAGE DISCONNECT POWER BEFORE ATTEMPTING INSTALLATION OR SERVICING.
- TO AVOID ELECTRIC SHOCK OR COMPONENT DAMAGE ,DO NOT USE THE CCT SWITCH AND POWER RANGE SWITCH AFTER INSTALLATION
- THIS PRODUCT MUST BE INSTALLED IN ACCORDANCE WITH THE NATIONAL ELECTRIC CODE (NEC) AND ALL APPLICABLE FEDERAL, STATE AND LOCAL ELECTRIC CODES AND SAFETY STANDARDS.
- USE CAUTION WHEN HANDLING THIS PRODUCT DURING OR AFTER OPERATION AS IT MAY BECOME HOT AND CAUSE BURNS. DISCONNECT PRODUCT AND ALLOW COOLING PRIOR TO SERVICING.
- ANY ALTERATION OR MODIFICATION OF THIS PRODUCT IS EXPRESSLY FORBIDDEN AS IT MAY CAUSE SERIOUS PERSONAL INJURY, DEATH, PROPERTY DAMAGE AND/OR PRODUCT MALFUNCTION.
- TO PREVENT PRODUCT MALFUNCTION AND / OR ELECTRICAL SHOCK THIS PRODUCT MUST BE PROPERLY GROUNDED.

What's in the box.

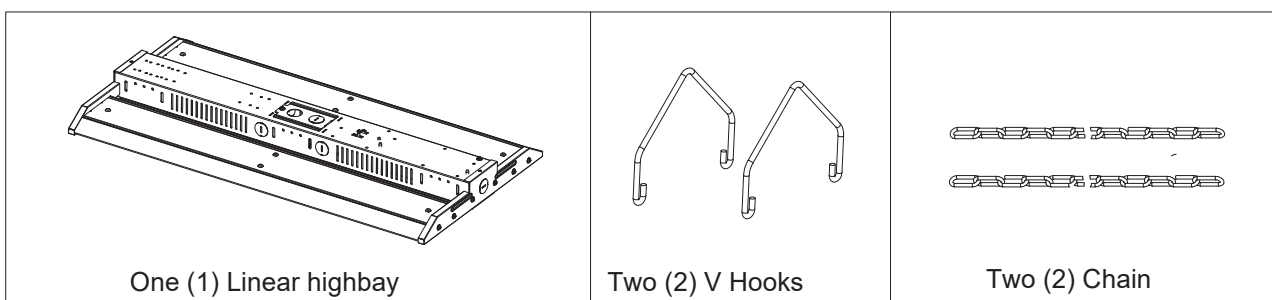

LED Linear High Bay

Installation Instruction: V-hook and Chain Mounting

- ① Unpack the fixture from its packaging. Inspect product for defects due to shipping.

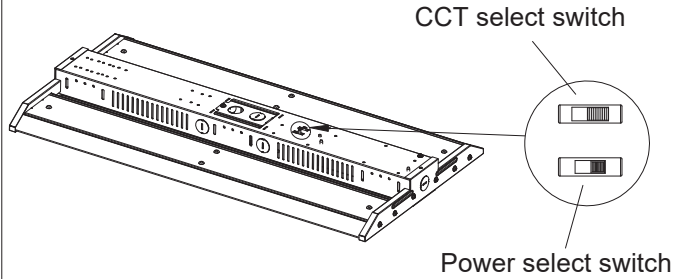

- ② Attach the provided chain securely to the included V-hook, then insert the V-hook into the slotted holes, as shown below, located at each end of the fixture junction box.

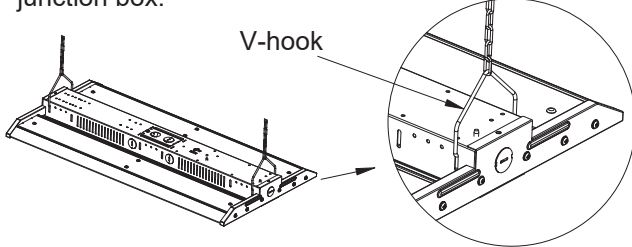

- ③ Attach chain kit to mounting surface (Fasteners provided by others)

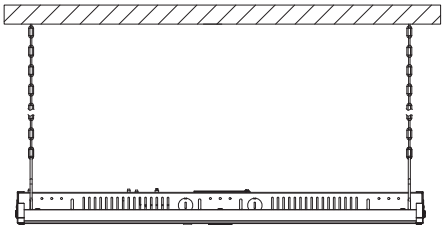

- ④ Remove wire cover and make wiring connections per the wiring diagram. Secure cover when complete.

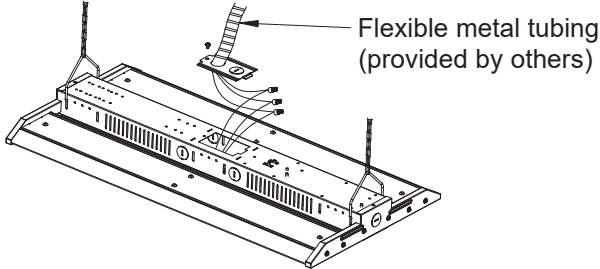

Installation Instruction: Sensor

- ① Unscrew and remove sensor socket cover.

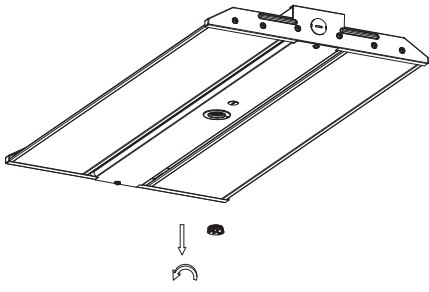

- ② Align sensor with socket and screw sensor into fixture. Do not overtighten.

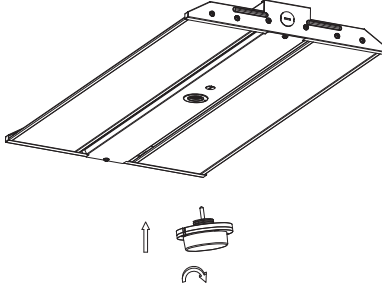

LED Linear High Bay

Light Distribution Testing Parameters

165W

LUMINAIRE PHOTOMETRIC TEST REPORT

Test:U:120.38V I:1.2752A P:153.34W PF:0.9989 Freq:59.98Hz		
UTHdi:0.00% ITHdi:0.00% KDisp:0 Lamp Flux:24798.1x1 lm		
NAME: 1000033522 SZ-LHB165W-2FT-ACP	TYPE:	WEIGHT:
SPEC.:	DIM.:	SERIAL No.:
MFR.: EVERFINE	SUR.: 0.6*0.306	Shielding Angle:

DATA OF LAMP		PHOTOMETRIC DATA			
Model	SZ-LHB165W-2FT-ACP	Imax (cd)	11066	S/MH (C0/180)	1.26
NOMINAL POWER (W)	165	LOR (%)	100.0	S/MH (C90/270)	1.25
RATED VOLTAGE (V)	120	TOTAL FLUX (lm)	24798	η UP, DN (C0-180)	0.4, 52.2
NOMINAL FLUX (lm)	24798.1	CIE CLASS	DIRECT	η UP, DN (C180-360)	0.4, 47.1
LAMPS INSIDE	1	η up (%)	0.8	CIBSE SHR NOM	1.25
TEST VOLTAGE (V)	120	η down (%)	99.2	CIBSE SHR MAX	1.35

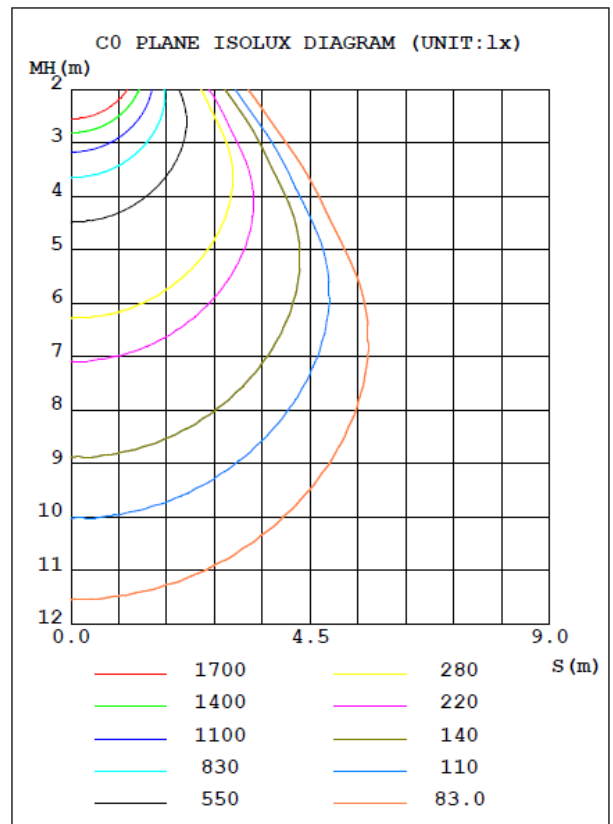
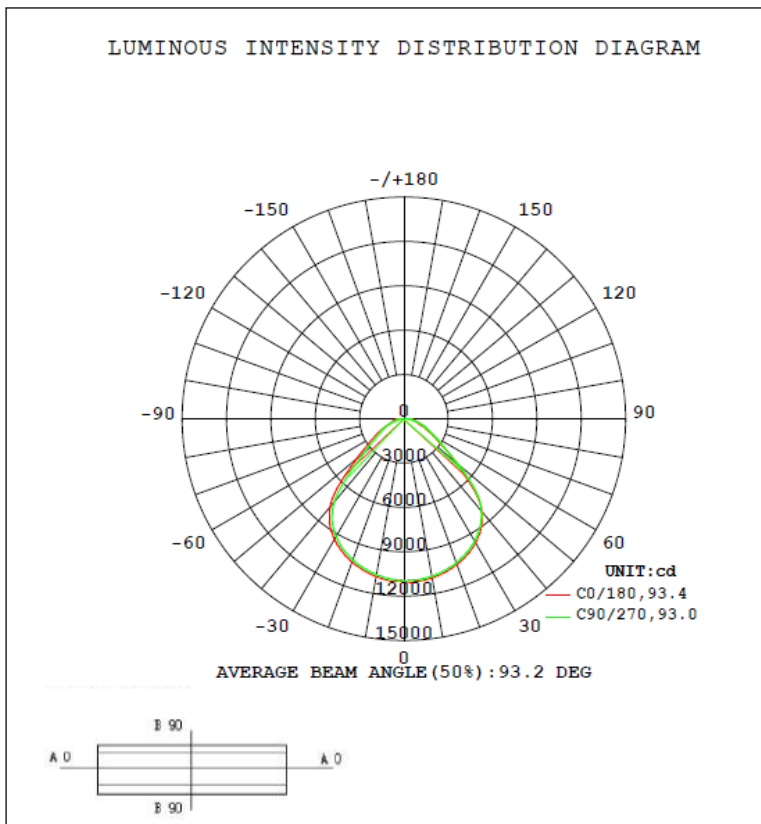

LED Linear High Bay

Light Distribution Testing Parameters

300W

LUMINAIRE PHOTOMETRIC TEST REPORT

Test:U:277.30V I:1.1025A P:288.57W PF:0.9439 Freq:59.98Hz		
UTHDi:0.00% ITHDi:0.00% KDisp:0 Lamp Flux:44241.5x1 lm		
NAME: SZ-LHB300WM-4FT-ACP	TYPE:	WEIGHT:
SPEC.:	DIM.:	SERIAL No.:
MFR.: EVERFINE	SUR.: 1.163*0.315	Shielding Angle:

DATA OF LAMP		PHOTOMETRIC DATA			
MODEL	SZ-LHB300WM-4FT-ACP	Imax (cd)	20926	S/MH (C0/180)	1.27
NOMINAL POWER (W)	300	LOR (%)	100.0	S/MH (C90/270)	1.28
RATED VOLTAGE (V)	277	TOTAL FLUX (lm)	44241	η UP, DN (C0-180)	0.4, 47.7
NOMINAL FLUX (lm)	44241.5	CIE CLASS	DIRECT	η UP, DN (C180-360)	0.4, 51.5
LAMPS INSIDE	1	η up (%)	0.8	CIBSE SHR NOM	1.25
TEST VOLTAGE (V)	277	η down (%)	99.2	CIBSE SHR MAX	1.35

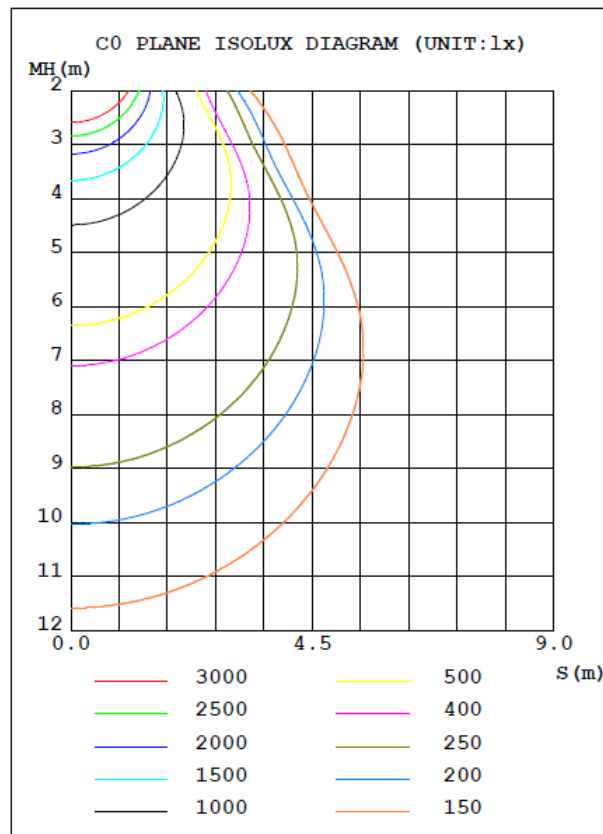
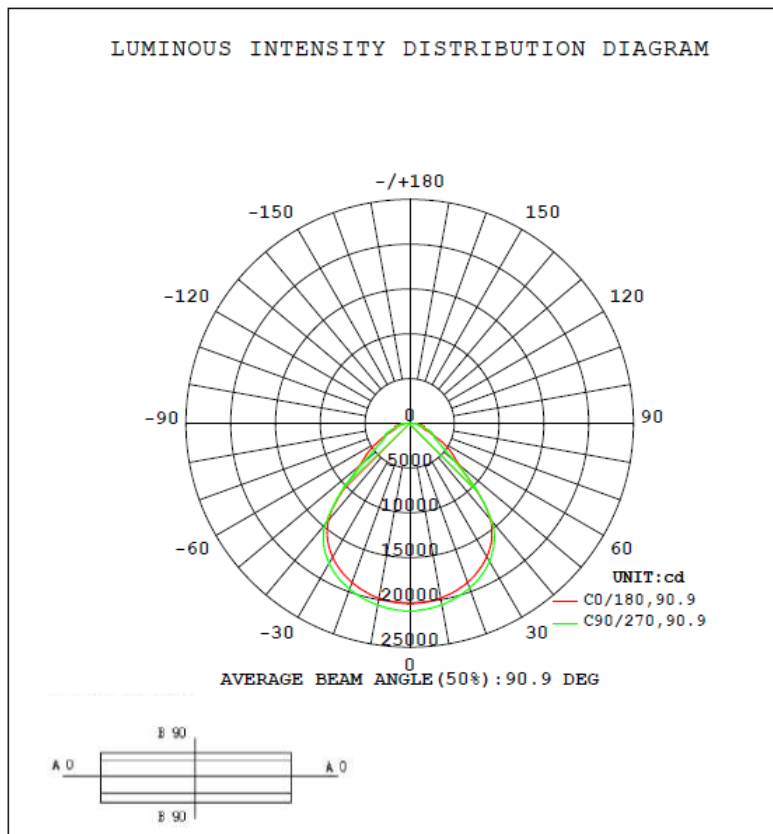

LED Linear High Bay

Light Distribution Testing Parameters

500W

LUMINAIRE PHOTOMETRIC TEST REPORT

Test:U:119.79V I:4.0942A P:490.07W PF:0.9992 Freq:60.01Hz		
UTHDi:0.64% ITHDi:3.20% KDisp:1.000 Lamp Flux:69501.1lx1 lm		
NAME: SZ-LHB500W-4FT-ACP	TYPE: SZ-LHB500W-4FT-ACP	WEIGHT:
SPEC.: 100~277V	DIM.: 0.32*1.16	SERIAL No.: 01
MFR.: EVERFINE	SUR.: 0.32*1.16	Shielding Angle:

DATA OF LAMP		PHOTOMETRIC DATA			
MODEL	SZ-LHB500W-4FT-ACP	Imax (cd)	31257	S/MH(C0/180)	1.28
NOMINAL POWER (W)	500	LOR (%)	100.0	S/MH(C90/270)	1.28
RATED VOLTAGE (V)	120	TOTAL FLUX (lm)	69501	η UP, DN (C0-180)	1.1, 47.3
NOMINAL FLUX (lm)	69501.1	CIE CLASS	DIRECT	η UP, DN (C180-360)	1.0, 50.6
LAMPS INSIDE	1	η up (%)	2.1	CIBSE SHR NOM	1.25
TEST VOLTAGE (V)	120	η down (%)	97.9	CIBSE SHR MAX	1.35

