

## LED High Bay Light

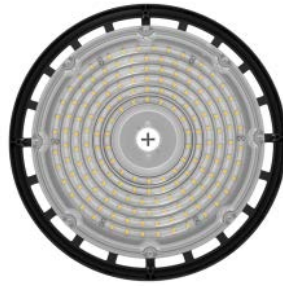

A unique feature for this fixture is the quick disconnected cable, it can quickly separate the driver from the LED module for easy maintenance. The unit has built-in heat sink and comes with a hook made of die-cast aluminum for a strong and easy installation.



Catalog Number	Description	Angle	Lumens	Watts	CCT	Voltage
SZ-HB150W-ACP	LED High Bay Light	90°	22500 Lm)	Adjustable 100W/120W/150W	Adjustable 4000K/5000K/6000K	120V - 277V Optional 120-347V,277-480V
SZ-HB240W-H-ACP	LED High Bay Light	90°	36000 Lm	Adjustable 150W/200W/240W	Adjustable 4000K/5000K/6000K	120V - 277V Optional 120-347V,277-480V
SZ-HB300W-H-5700K	LED High Bay Light	90°	45000 Lm	300W	5700K	120V - 277V Optional 120-347V,277-480V

### ORDERING GUIDE

Example: SZ-HB240W-H-ACP

Company Code	Fixture Type	Wattage	High Efficiency	Voltage	ACP or CCT
<input type="text"/>	<input type="text"/>	<input type="text"/>	<input type="text"/>	<input type="text"/>	<input type="text"/>
SZ Company Name	HB High Bay Light	150W 240W 300W	H high Efficient	Blank 120-277V MV 120-347V HV 277-480V	ACP Adjustable CCT and Power 150W:100/120/150W 4000K/5000K/6000K 240W:150/200/240W 4000K/5000K/6000K  CCT 300W 5700K

### Accessories



Rings (Sold Separately)



Hook (Standard)



Yoke (Sold Separately)

## LED High Bay Light

### Specifications

#### Housing

Sealed die-casting profile for outdoor applications.

#### Mounting

Hook, Rings and Yoke.

#### Electrical

Standard 120V - 277V, Optional 120-347V and 277-480V  
0-10V dimming standard with a dimming range of 100% to 10%. PF > 0.9. Surge protection: 6KV.

#### CCT and CRI

Adjustable 4000K/5000K/6000K. CRI 70.

#### Angle

Standard 90°

#### Operating Temperature

Suitable for use in -40° C to 45° C (-40° F to 113° F).

#### Efficacy

Up to 150 lumens per watt.

#### Lifespan

L70 >50,000 Hours at 25°C (77°F).

#### Certifications

UL Listed for wet locations, DLC5.1, FCC compliant, IP65 rated.

#### Warranty

5-year limited warranty.

### Product Structure Characteristics:



Easy, screw-in sensors for all your needs.

**WATT/CCT**  
SELECTABLE



### Accessories

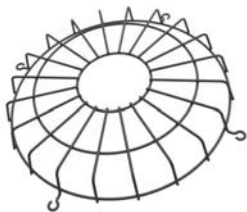

Wire Guard



90° Aluminum Reflector



90° PC Reflector



bottom cover for PC reflector



Safety Rope



Hanging Chains



SZ-EMXXW-HB  
Emergency Driver



SZ-MS-MH1: Microwave sensor  
SZ-PS-A: Photocell sensor



SZ-MS-MH1K5  
Plug-and-Play Microwave and  
PhotoCell Sensor, 5 Manual  
Switches, easy programming



SZ-MS-RC1  
Sensor Remote

## LED High Bay Light

### Dimension:

150W

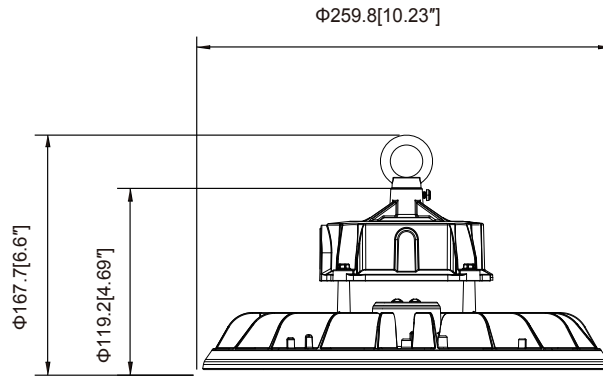

240W

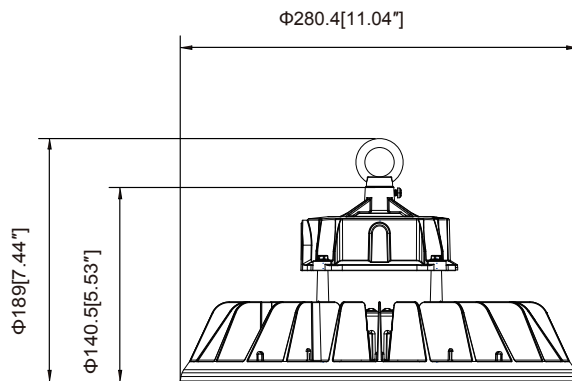

300W

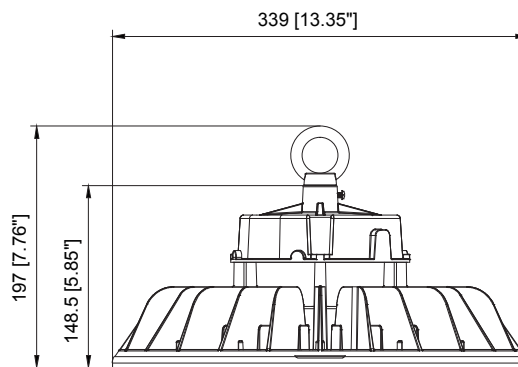

### Packing/Weight:

Model	Outer box (L*W*H)	Qty/CTN (pcs)	N.W./pcs (lbs/kg)	G.W./CTN (lbs/kg)	Remark
SZ-HB150W-ACP	10.59* 10.59**5.63" 269*269*143mm	1	3.3/1.5	4.18/1.9	2M Cable
SZ-HB240W-H-ACP	11.38**11.38**6.38" 289*289*162mm	1	4.84/2.2	5.72/2.6	
SZ-HB300W-H-5700K	13.82**13.82**7.48" 351*351*190mm	1	6.95/3.16	8.36/3.8	

## LED High Bay Light

### INSTALLTION INSTRUCTION:

#### 1.Rings type:

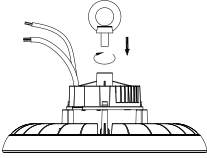
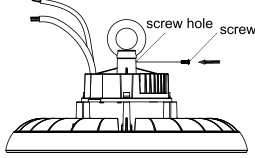
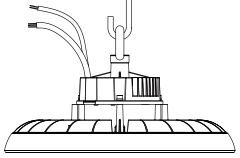
<p>1.Lock the ring.</p> 	<p>2.Tighten the screw. (This step can be omitted if there is no screw hole.)</p> 	<p>3.Hang up the light.</p> 
---	---	---

#### 2.Hook type:

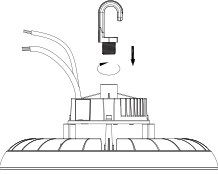
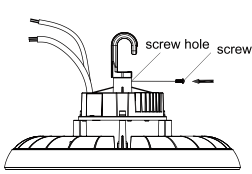
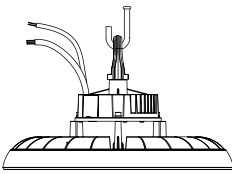
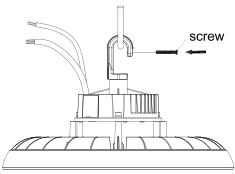
<p>1.Lock the hook.</p> 	<p>2.Tighten the screw. (This step can be omitted if there is no screw hole.)</p> 	<p>3.Hang up the light.</p> 	<p>4.Lock the screw.</p> 
---	---	--	--

#### 3.YOKE type:

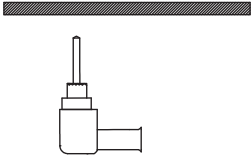
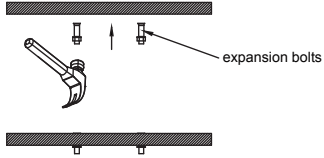
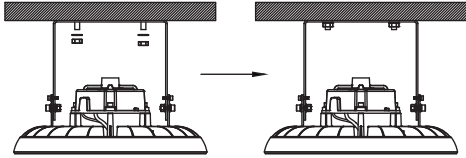
<p>1.Bracket fixing holes are marked on the wall, then drilling two holes on the wall by power drill, as shown in Figure1.</p> 	<p>2.Tap two expansion bolts into the holes, as shown in Figure2.</p> 	<p>3.Put the fixture on the expansion bolt, then use a wrench to tighten the screw. as shown in Figure3.</p> 
--	--	--

#### 4.Sensor installation:

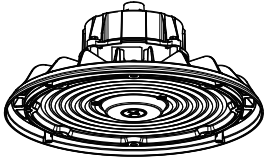
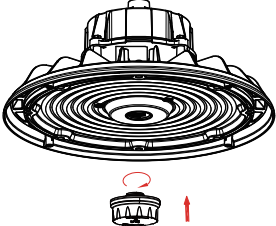
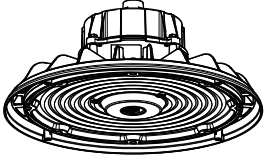
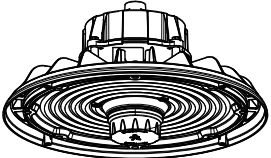
<p>1.Unscrew the plug screws using screws, as shown in Figure 1.</p>  <p>3.Screw the sensor into the base, as shown in Figure 3.</p> 	<p>2.Remove the plug screw, as shown in Figure 2.</p>  <p>4.Sensor installation, as shown in Figure 4.</p> 
---	---

#### WIRING CONNECTION:

Turn off the power,connect AC wire.Black wire to L,white wire to N,and green wire to PE.

Dimmer connection(with dimmable driver.)

1. Compatible with 0-10V dimming.

2. Connect wires as below, Pink 0-10V Dimming purple wire is D+,pink wire is D-,cap red wire.

