

## LED Panel Light



This Panel is field-adjustable, and can be programmed with a CCT of 3500K, 4000K, 5000K, 5700K, 6500K, eliminating the need to stock multiple color temperatures.

Ideal use for office spaces, walkways, schools/campuses, shopping centers, hospitality and



Catalog Number	Description	Lumens	Watts	CCT	Voltage
SZ-PL14-A40W-CCT	LED Panel - 1' x 4'	5000 Lm	Adjustable 40 W Max	Adjustable 3500K - 6500K	120V - 277V
SZ-PL22-A40W-CCT	LED Panel - 2' x 2'	5000 Lm	Adjustable 40 W Max	Adjustable 3500K - 6500K	120V - 277V
SZ-PL24-A72W-CCT	LED Panel - 2' x 4'	9000 Lm	Adjustable 72 W Max	Adjustable 3500K - 6500K	120V - 277V

### ORDERING GUIDE

Example: SZ-PL22-A40W-CCT

Company Code	Fixture Type	Size	Wattage	Voltage	Sensor (optional)	CCT Kelvin
SZ Company Name	PL Panel	14 1' x 4' 22 2' x 2' 24 2' x 4'	A40W A72W	Blank 120-277V	Blank Without Photocell/Sensor S Sensor base (option)	CCT Adjustable CCT and Power 40W: 15/20/25/30/40W or 20/25/30/35/40W 3500/4000K/5000K/5700/6500K or 3000/3500/4000/5000/6000K 72W: 30/40/50/60/72W 3500/4000K/5000K/5700/6500K or 3000/3500/4000/5000/6000K

## LED Panel Light

### Specifications

#### CONSTRUCTION

Durable solid frame, prefabricated paint with matte white finished. Slim profile design. Integrated T-Bar mounting clips built in onto the fixture. Easy installation.

#### ELECTRICAL

Luminaire is built with the highest quality 120-277VAC drivers.

#### OPTICAL SYSTEM

Designed to reduce glare and improve light distribution through precision formed

#### Operating Temperature

Suitable for use in -20° C to 45° C (-4° F to 113° F).

#### Efficacy

125 lumens per watt.

#### DIMMING

0-10V dimmable standard.

#### Certifications

ETL Listed, FCC, DLC 5.1.

#### WARRANTY

5 Years Limited Warranty.

### Dimensions

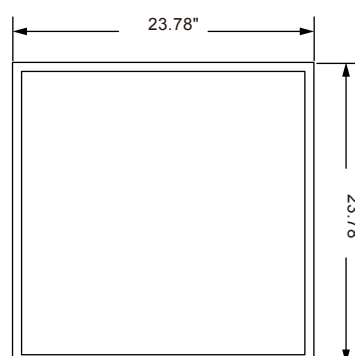
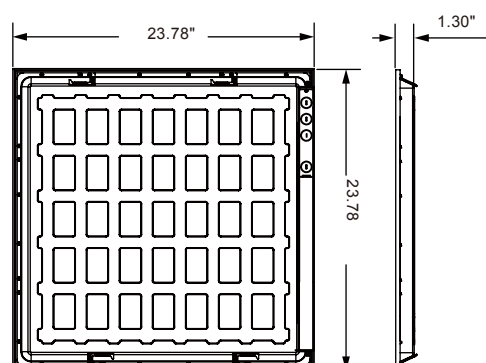
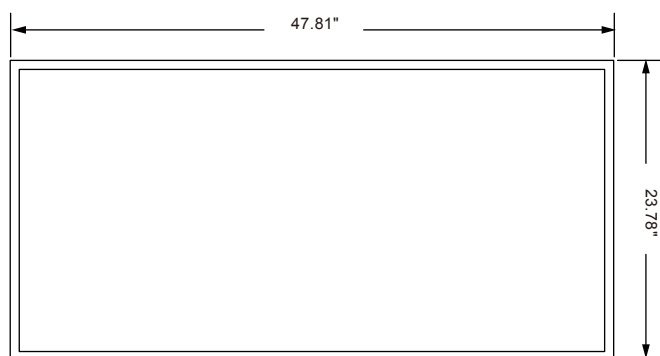
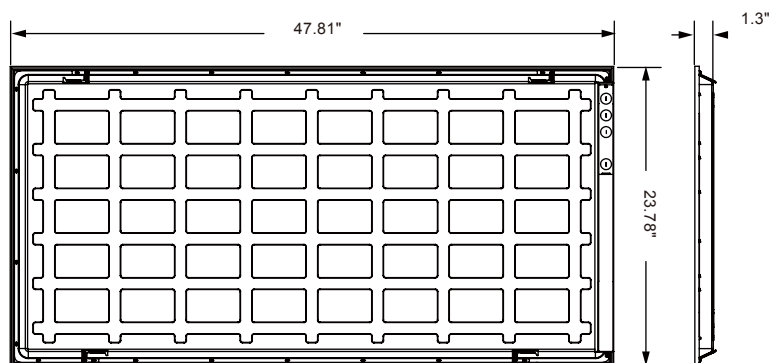
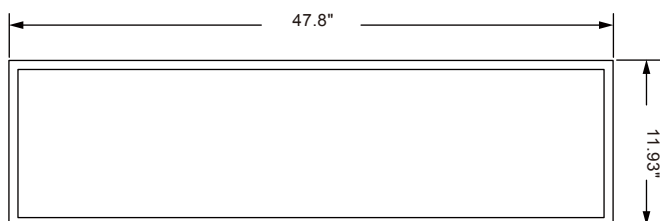
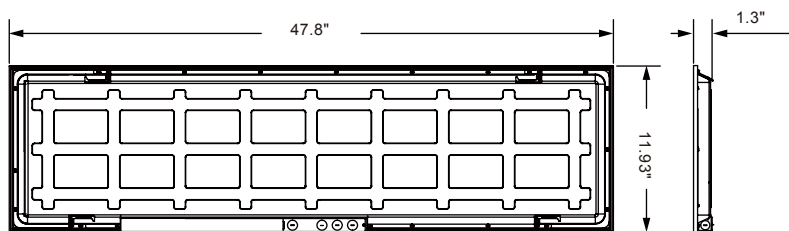

### Accessories (Optional):

1. Emergency Driver: Recharge time:  $\geq 24$ Hrs, Discharge time :>90minutes.
2. Sensor: PIR Sensor or Microwave Sensor.

### Emergency Driver (Optional)



SZ-EMXXW-PL



SZ-EMXXW-PL (02)

### Sensor (Optional With Sensor Base)

Microwave Sensor  
SZ-MS-M

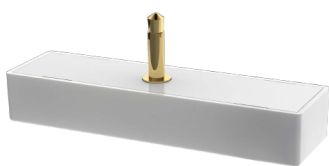

PIR Sensor  
SZ-MS-P

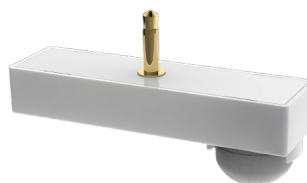

### Wiring



VCC Black&White wire GND Pink wire 0-10V Purple wire

