

schweigen X

PASSIONATE PRECISION

SXWU295-9S

Rangehood & Installation Guide

**Scan for the latest
digital manuals**



Under our policy of continuous product development, product specifications may change without notice. Please refer to the online version of the manual for the latest updates and specifications.



WELCOME	3	Roof Mounted Motor System Overview	21
YOUR SAFETY	4	Wall Mounted Motor System Overview	22
Before Installation	5	CONDENSATION INFORMATION	23
Product Use	6	Cooking with Induction Cooktops	23
Electrical Cord	6	TROUBLESHOOTING	24
DESCRIPTION	7	Troubleshooting	24
Rangehood	7	Service	25
Cutout Size	7	DISCLAIMER	26
SPECIFICATIONS	8	Disclaimer	26
Dimensions	8	Disposal of Old Appliances	26
Technical Specifications	8		
LED Light Specifications	8		
OPERATION	9		
Touch Button Control Panel	9		
Remote Control	9		
Speed Control	9		
CLEANING & MAINTENANCE	10		
Cleaning the Interior	10		
Cleaning the Exterior	10		
Filters	11		
Replacing The LED Light	12		
INSTALLATION	14		
Overhead Cabinet Rangehood Installation Position	14		
Rangehood Size Vs Cooktop Size	15		
Rangehood Installation Height	16		
Recommended Installation Height For Induction Cooktop	16		
Mounting Points for Body	17		
Installation Example	18		
Optional Back Outlet Configuration	19		
Ducting	20		

Welcome

Thank you for purchasing your new Schweigen X rangehood.

To get the maximum output from this unit, please read through this guide before installation and use.

This guide contains important information on the use and maintenance of the unit, as well as important safety notes. This will ensure your personal safety and the lasting value of your rangehood.

We trust that you will enjoy your new Schweigen X rangehood.

PLEASE ALWAYS RETAIN YOUR PROOF OF PURCHASE TO AID IN ANY WARRANTY QUERIES.

If you are unable to locate your warranty card, one is available to download from our website www.schweigen.com.au.

This appliance and its packaging are produced by processes that minimise waste and respect the environment.

Please help us to continue our effort to protect the environment by using the appliance efficiently and dispose of the packaging in a responsible manner.

! Your State Regulatory Authority

Different Australian states have varying legislative requirements for the installation of rangehood ducting. Some will insist on ducting being vented externally (i.e. not in to the ceiling cavity); others will not. It is imperative that you check with your state building authority and/or private certifier to confirm their position.

! WARNING

Please read this section thoroughly before attempting to operate the rangehood. Thoroughly inspect your rangehood on delivery for any damage or defect. Any damage or defects **MUST** be reported within **48 hours**, or no claim will be recognised.

DO NOT INSTALL THIS APPLIANCE IF YOU FIND IT DAMAGED.

If this rangehood is installed damaged, neither the supplier, nor the retailer will be responsible for the costs associated with the repair, replacement, removal or re-installation of the rangehood.

1. This rangehood is suitable for installation in an indoor kitchen only.
2. There shall be adequate ventilation in the room when the rangehood is used at the same time as appliances burning gas or other fuels.
3. There is a risk of fire if cleaning is not carried out in accordance with the instructions.
4. Do not flambé under the rangehood. This will damage the rangehood and will not be covered by warranty.
5. Do not ignite burners that give off intense, uncontrolled flames beneath the rangehood.
6. Make sure that no flames emerge from the sides of pans.
7. Do not leave packaging materials (bags, corner brackets, etc) within reach of children.
8. This appliance is not intended for use by person/s (including children) with reduced physical, sensory or mental capabilities, or lack of experience and/or knowledge, unless the person has been given supervision or instruction concerning the use of the appliance by a person responsible for their safety. Children should be supervised to ensure that they do not play with the appliance, it is not a toy.
9. Exhaust air must not be discharged into an existing flue that is used for exhausting fumes from appliances burning gas or other fuels.
10. Air exhaust must be installed in accordance with local laws. Regulations concerning the discharge of air have to be fulfilled.
11. Accessible parts may become hot when used with cooking appliances.
12. Before performing any cleaning or maintenance operation, disconnect the rangehood from the mains the double-pole switch or by unplugging it.
13. Do not use the rangehood without the grease filters.
14. Keep the grease filters clean and follow the recommended cleaning frequencies.
15. Turn the rangehood motor on before starting to cook.
16. Turn the rangehood motor off about 10–15 minutes after you finish cooking.
17. The rangehood is not to be used as an aspirator.
18. Never cook foodstuff directly over the flame or have the gas burners on under the rangehood without using cookware.

BEFORE INSTALLATION

1. We recommend that this rangehood be installed or repaired by an experienced home appliance technician.
2. Please see our website www.schweigen.com.au | www.schweigen.co.nz for experienced installers.
3. It is dangerous to modify any part of this appliance. Modification of any kind, will void the warranty.
4. The manufacturer declines all responsibility in case of failure to adopt proper safety measures.
5. Ensure that the location of the rangehood has good ventilation.
6. Please consult state and federal regulations regarding installation of the rangehood and ducting.
7. Schweigen Home Appliances will not be responsible for installations executed by non-qualified installers and installations that fail to meet legislation requirements.
8. Any electrical work required to install this rangehood should be carried out by a qualified Electrician.
9. This appliance must be connected to an electricity supply with a ground connection.
10. The electrical technical data can be found inside the rangehood, after removing the grease filters.
11. The flexible power cable supplied is already connected internally and emerges from the rangehood near the air outlet tube.
12. Before installing the electrical connections, you should:
 - Always switch off power using the double-pole switch before maintenance and turn the power on again for normal use only when the maintenance has been completed.
 - Verify that the indicated electrical data coincides with the voltage values and frequency of the electrical circuit in the house where the rangehood is to be installed.
 - Check that the premises has electrical protection against short circuits and electrocution, pursuant to the applicable legislation.

PRODUCT USE

This rangehood is designed to be used in households and for non-commercial uses such as:

- Staff kitchen areas in shops, offices and other working environments.
- By clients in hotels, motels and other residential environments, excluding commercial kitchens.
- Bed and breakfast type environments.

This rangehood is not designed for outdoor or alfresco installation.

Rangehoods and other cooking fume extractors may adversely affect the safe operation of appliances burning gas or other fuels (including those in other rooms) due to back flow of combustion gases. These gases can potentially result in carbon monoxide poisoning. After installation of a range hood or other cooking fume extractor, the operation of flued gas appliances should be tested by a competent person to ensure that back flow of combustion gases does not occur.

ELECTRICAL CORD

Ensure the power supply cord is not exposed to heat, chemicals or sharp objects. If the power supply cord is damaged, it must be replaced by the manufacturer.

Description

RANGEHOOD

1. Socket lead to Isodrive® motor
2. Main Power cord
3. Rangehood body
4. LED strip lights
5. Baffles
6. Mesh filters (optional)
7. Remote Control

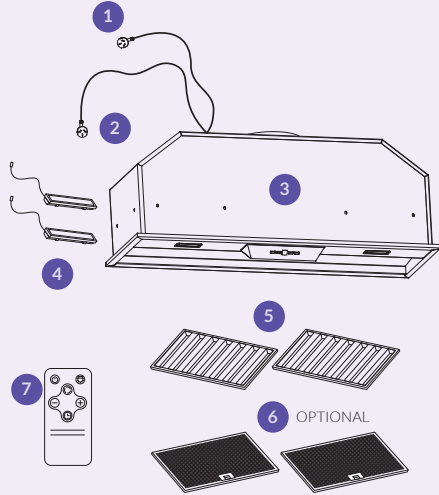

CUTOUT SIZE

To ensure the correct fit for your rangehood in your cabinetry, use the below dimensions as a guide. It is always best to send your rangehood to your cabinet maker to ensure the correct fit prior to installation.

875mm approx.

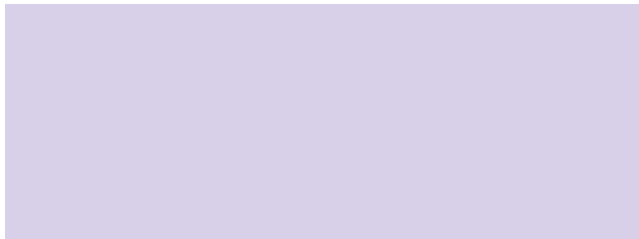

275mm approx.

Dimensions may be subject to change.

DIMENSIONS

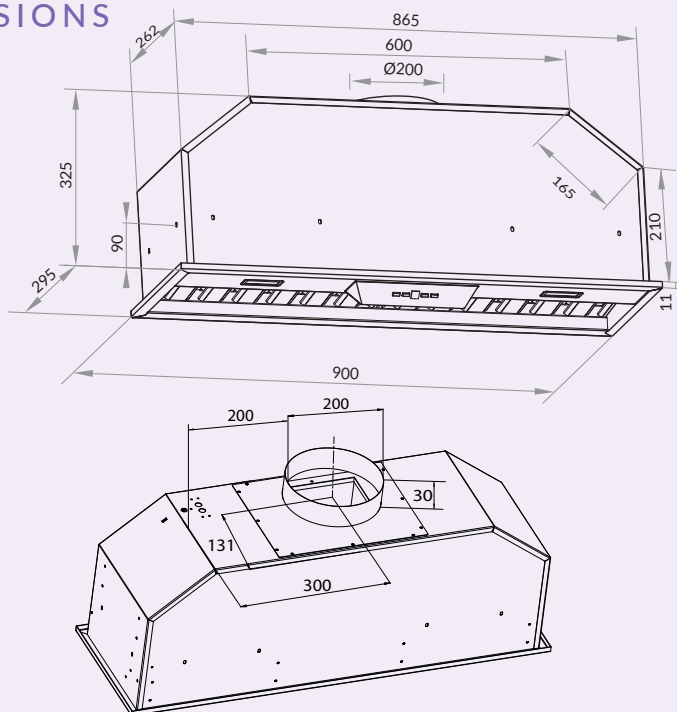

TECHNICAL SPECIFICATIONS

Model	SXWU295-9S
Feeding Voltage	220-240V 50Hz
Lamp Power – LED Light x 2 (W)	3W each
Weight	14kg

LED LIGHT SPECIFICATIONS

Description	LED linear light (W type LED light strip)
Rated wattage of the intended lamp	3W
Max wattage of a potential replacement lamp	3W
Nominal dimensions	70mm (L) x 28mm (W) (W type)
ILCOS Code	DSL-2-S-70/28
Rated voltage	12V DC

Operation

TOUCH BUTTON CONTROL PANEL

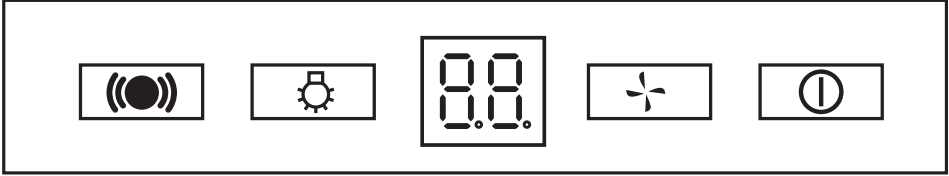

 Remote control sensor

 Turn light on/off

 Fan speed setting

 Turn rangehood on/off

REMOTE CONTROL

As well as the touch buttons, this undermount rangehood comes with a remote control to operate the rangehood.

1. Use this button for activating and deactivating the motor.
2. Changes the speed of the motor (minimum level is 1, maximum is 5)
3. Automatically changes the speed to maximum or minimum speed.
4. Turns the lights on or off.
5. 10 minute timer.

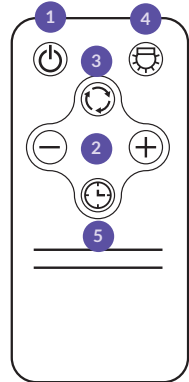

SPEED CONTROL

This undermount is equipped with a 5 speed touch control.

Speed control usage suggestions:

- **Low speed** for simmering.
- **Medium speed** for light cooking.
- **High speed** for heavy frying/cooking.

To activate the shutdown timer on the Touch Button Control Panel: When the rangehood is in operation and a fan speed has been chosen, press the on/off button once to activate the timer. The button will flash to indicate that the 10 minute timer has been activated.

! WARNING

Always switch off and disconnect power before cleaning.

CLEANING THE INTERIOR

Clean the interior of the rangehood with a damp cloth and a neutral detergent.

NOTE: Do not use denatured alcohol on the interior of the rangehood. Do not clean the electric parts or the motor with liquids or solvents.

CLEANING THE EXTERIOR

We recommended rinsing a soft cloth in water and liquid detergent. Wring dry before wiping surfaces dry. For better results, you can use high quality cleaning and protection products to clean your rangehood.

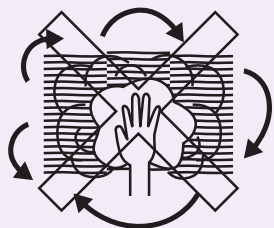
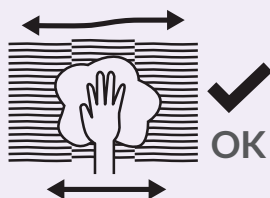

- The recommended detergent is a solution of water and a neutral liquid soap.
- It is very important for the liquid soap to not contain granules that could scratch the surface.
- First apply the solution to a soft cloth and then rub the cloth over the rangehood. It is important to follow the direction of the surface with the cloth (refer to figure on left).
- Do not pour any liquid directly on to the rangehood.
- The cloth must have no buttons, zips or fasteners that could scratch the surface.
- Chemical solvents, aggressive, grainy or abrasive products, naphtha, alcohol or similar products that could damage the surface of the rangehood should not be used.
- The manufacturer will not be held responsible for functional or aesthetic damage caused by cleaning with products which are not suitable or using inadequate cleaning methods.

Cleaning & Maintenance

FILTERS

For this rangehood to function effectively, regular maintenance is a must.

- The function of the filter is to absorb the airborne grease particles from cooking.
- Clogged mesh filters and heavy oil deposits in baffles restrict airflow, cause leaks onto the cooktop and may cause the motor to overheat and become a fire hazard.
- Filters should be cleaned every 3–6 weeks or after 40 hours of use.
- For induction cooktops, aim to clean filters at least every 10 days, depending on use.

- Filters and baffles can be washed by hand or in the dishwasher.
 - **Washing by hand:** Immerse the filter in hot water and a suitable detergent and when clean, rinse with plenty of hot water.
 - **Dishwasher:** Put the filter in the dishwasher and select a short program at low to mid temperature.

Please make sure the filters are completely dry before placing them back in position and using the rangehood.

MESH FILTERS (OPTIONAL)

To remove, lift up the lever on the filter and pull towards you.

Once clean and completely dry, replace by reversing the above instructions.

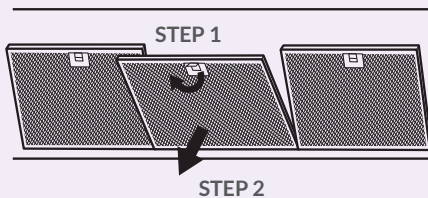

BAFFLES

Ensure the baffles are cold before removing to ensure oil deposits do not spill.

To remove, lift and angle the baffle to allow it to pass through the cavity.

Once clean and completely dry, replace by reversing the above instructions.

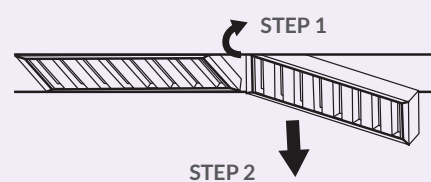

! NOTE

The colour of the metal mesh filters may change after several washes. This is normal and it is not necessary to replace the filters.



REPLACING THE LED LIGHT

! DANGER

Always switch off and disconnect the power cord before replacing any lights. Failure to do so may cause serious injury. Please be aware that the LED light will retain heat for a short period of time after being switched off. Never attempt to replace the LED by yourself, always refer to a qualified Service Technician.

STEP 1

Remove filters from rangehood.

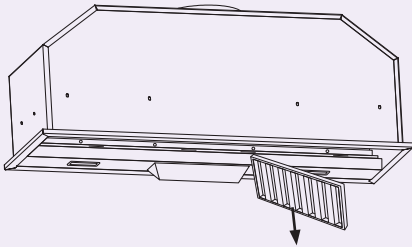

STEP 2

Unscrew the screws and tilt the panel forward. The entire panel will come out.

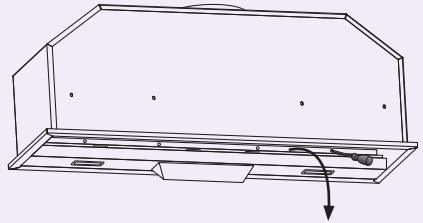

STEP 3

Looking inside the panel push the light out of the cavity.

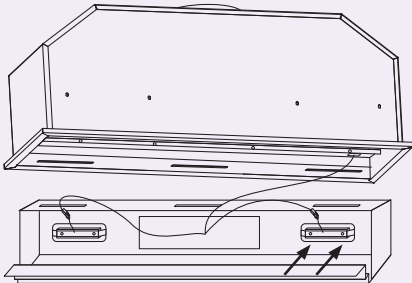

STEP 4

Unclip the cord by pushing in the side clips and pulling the cord.

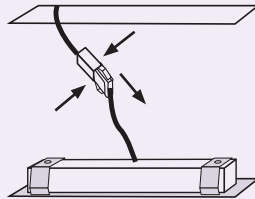

REPLACING THE LED LIGHT

STEP 5

Clip the new light cord in, and push the new light into place.

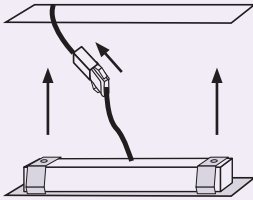

STEP 6

Refit the panel back to the rangehood. Ensure that the slots on the panel and the rangehood line up. Once in place, screw to secure.

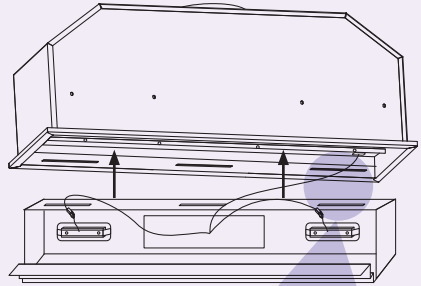

STEP 7

Fit the filters back into the rangehood.

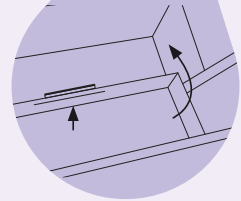
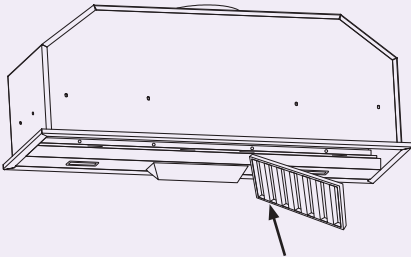

OVERHEAD CABINET RANGEHOOD INSTALLATION POSITION

The installation height and position of your rangehood will affect its performance. Schweigen recommends the rangehood be installed as close to the front of the cabinetry as possible. This will increase extraction efficiency as there will be greater coverage of the cooktop surface area.

As the diagram below shows, if deeper overhead cabinetry is built, and the rangehood is installed to the front of the cabinetry, a greater amount of air is extracted.

Please see the next page for Schweigen's recommended height for best performance.

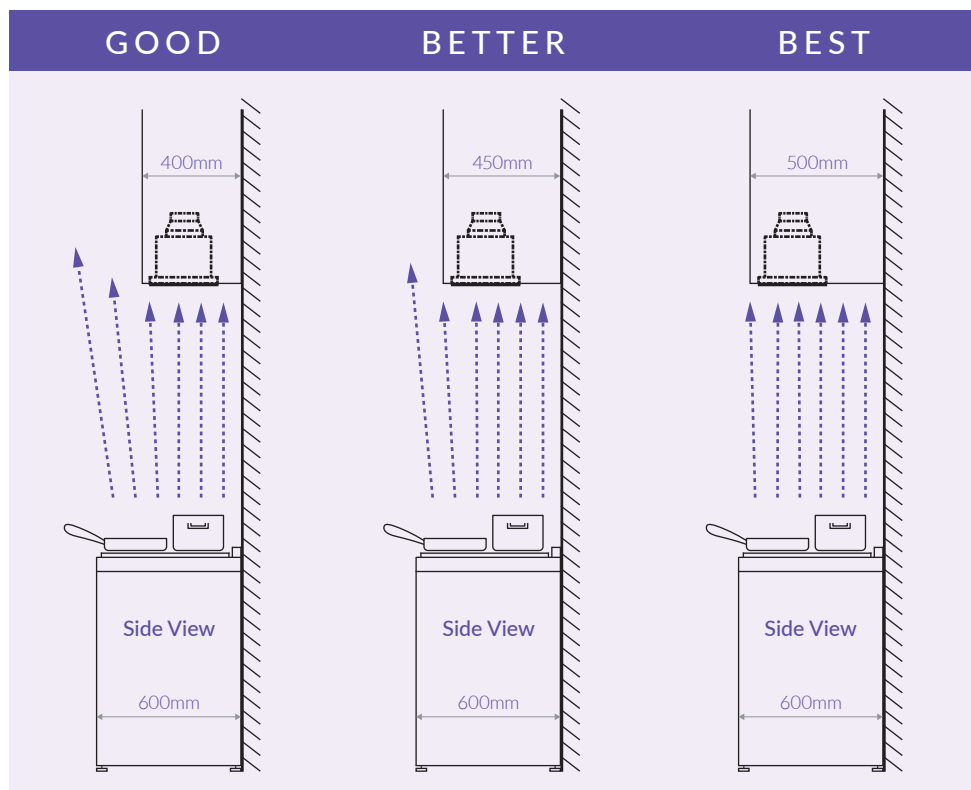

Installation

RANGEHOOD SIZE VS COOKTOP SIZE

To ensure optimal functionality and air extraction, the correct sized rangehood must be installed. As the diagram below highlights, the larger the rangehood the better the air extraction. At a minimum, the rangehood should be as wide as the cooking zone. A larger rangehood will ensure the best extraction for all burners.

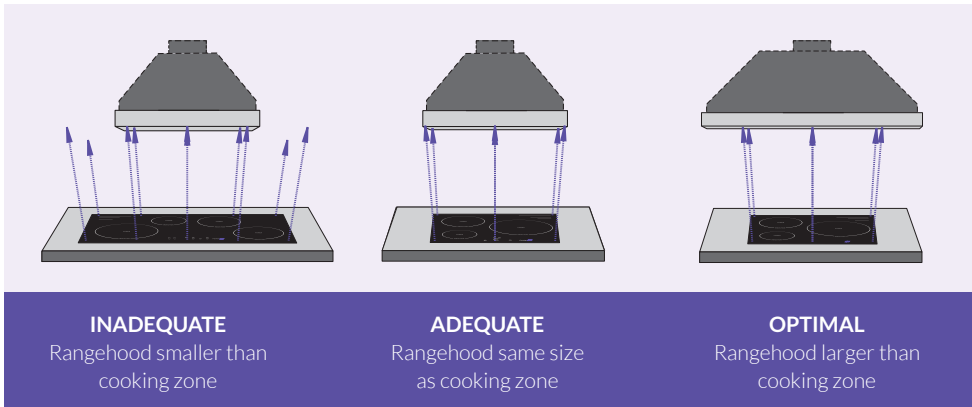

! IMPORTANT

In addition to the information in this manual, please check all relevant state requirements for minimum–maximum heights, as well as regulations regarding the expelling of air. Schweigen is not liable if your rangehood is not installed in accordance with these legal requirements.

! IMPORTANT

If the user decides to install the rangehood at a distance of less than minimum height above the cooking surface, Schweigen declines responsibility for any damage suffered by the rangehood due to excess heat or damage to objects, people and others caused directly or indirectly by a malfunction, breakage or fire.

RANGEHOOD INSTALLATION HEIGHT

It is **STRONGLY RECOMMENDED** that the rangehood be installed centrally over the cooktop. This will greatly improve its performance.

Minimum height from the hob surface to the underside face of the rangehood:

- 600mm electric cooktop
- 650mm gas cooktop

Any installation above 800mm will compromise the extraction performance.

Note: If the instructions for the gas cooktop specify a greater distance, this must be taken into account.

! IMPORTANT

Measurements are from the top of the trivets to the lowest part of the rangehood, including the button controls.

RECOMMENDED INSTALLATION HEIGHT FOR INDUCTION COOKTOP

To help avoid condensation, particular to cooking with an induction cooktop, Schweigen recommends a height between 700-750mm. Refer to page 23 for further information.

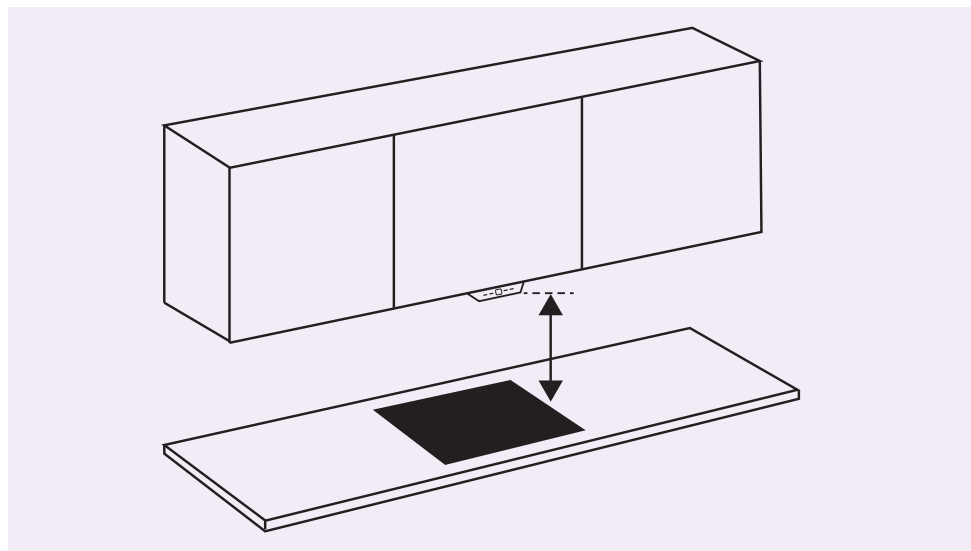

Installation

MOUNTING POINTS FOR BODY

The diagrams below are a guide for all mounting points.

SIDE VIEW

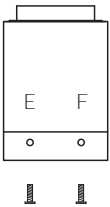

FRONT VIEW

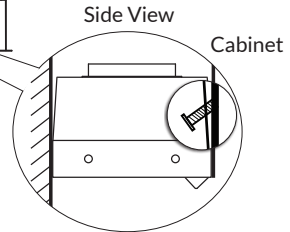
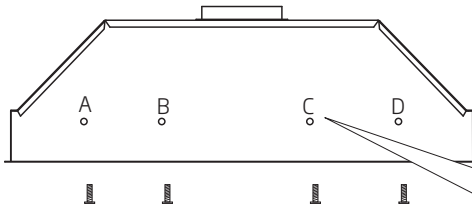

Mounting point A, B, C, D, E and F need to be tightened with slightly angled screws to pull the rangehood up tight to the cabinet.

! WARNING

Always switch off and disconnect the power supply before installing the rangehood. Failure to do so may cause serious injury.

! WARNING

Please remove filters before installation. Failure to do so may damage the clips.

INSTALLATION EXAMPLE

STEP 1

Insert mounting frame into cabinet. The support will only be needed in certain circumstances.

NOTE: The mounting frame is not included. The requirement of a mounting frame is dependent on the type and location of installation. Please contact your installer for more information.

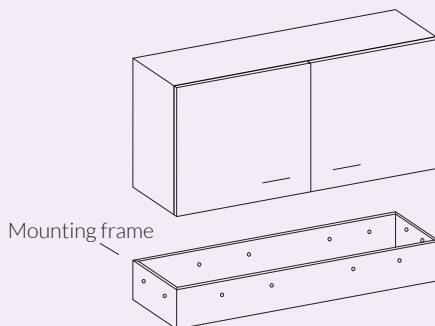

STEP 2

Secure mounting frame to inside of cabinet.

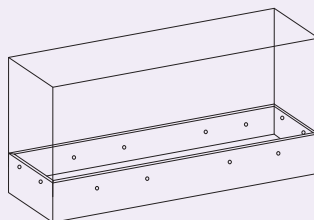

STEP 3

Secure the undermount into cavity using screws. All screws are installed internally into the mounting frame.

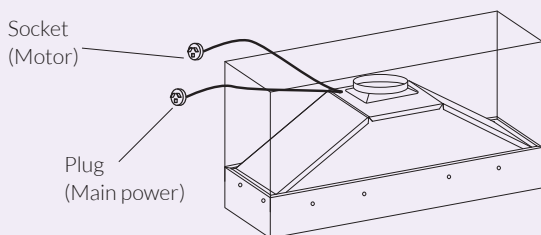

! NOTE

Remove all plastic protection on the rangehood and filters before use.

Installation

OPTIONAL BACK OUTLET CONFIGURATION

For installations with limited room above the rangehood, the rangehood can be reconfigured with the outlet on the back of the unit. Primarily this suits new buildings where adjustments to walls can be made – older houses may have limited space between the wall and rangehood.

The repositioning must be done prior to the rangehood being installed into the cabinetry.

STEP 1

Unscrew and remove the back panel cover.

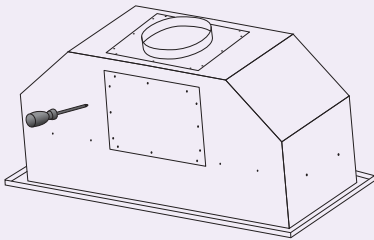

STEP 2

Unscrew and remove the outlet panel cover.

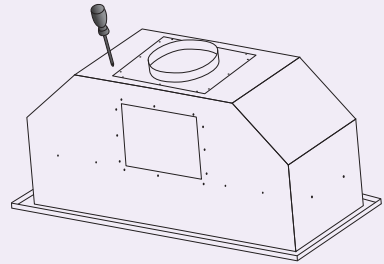

STEP 3

Place outlet panel over the back opening and screw into place.

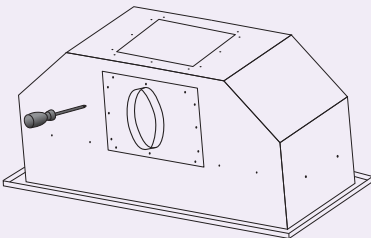

STEP 4

Place cover over the top opening and screw into place.

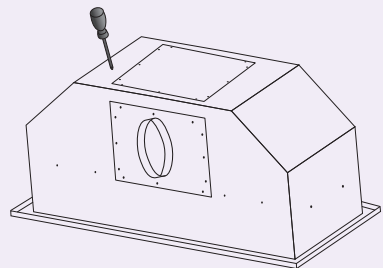

DUCTING

PLEASE DO NOT CRUSH OR KINK THE DUCTING

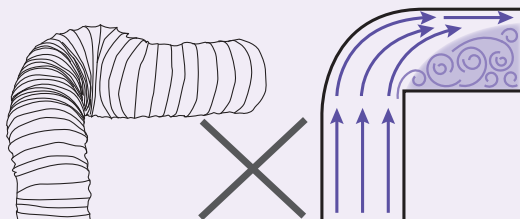

1. Crushed or kinked ducting or ducting with sharp corners create turbulence. This reduces the size and efficiency of the ducting, lowers extraction and can cause excessive noise.

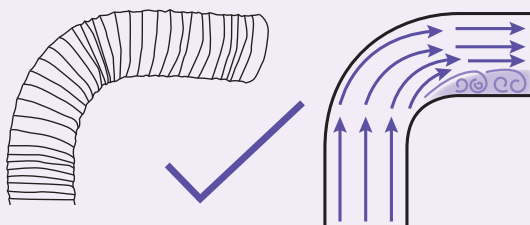

2. Sweeping curves and taut ducting reduces resistance and turbulence. The airflow and extraction will be more efficient and stronger.

Installation

ROOF MOUNTED MOTOR SYSTEM OVERVIEW

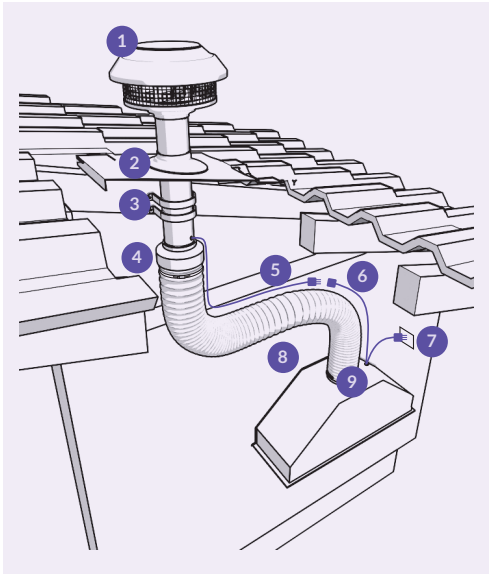

1. Isodrive® motor
2. Roof seal kit (Dektite) (not supplied)*
3. Support straps (not supplied)*
4. Attach duct to pipe using ring clamp. Please do not rip the ducting.
5. Isodrive® motor power lead (plug)
6. Rangehood to Isodrive® motor lead (socket)
7. Main power lead (plug, 10 amp)
8. Ducting must be pulled taut. Do not crush or kink the ducting.
9. Connect ducting to the outlet on rangehood using ring clamp. Please do not rip the ducting.

! NOTE

* The Isodrive® motor system does not include the roof seal kit, cable ties, or the support straps.

The general power outlet for the rangehood should be located in an easy to access area.

All electrical wiring from the motor to the rangehood should be kept inside the roof space.

WALL MOUNTED MOTOR SYSTEM OVERVIEW

The Isodrive motor can optionally be installed mounted to a wall if a roof mount is not possible. The construction of a bulkhead is also recommended. The position of the motor can be to an external wall, or to the same external wall as the rangehood is mounted, as shown below.

For all wall installation options, as well as recommended ducting lengths, please refer to the Isodrive® Motor manual. Avoid sharp bends and kinked ducting as this will affect extraction performance.

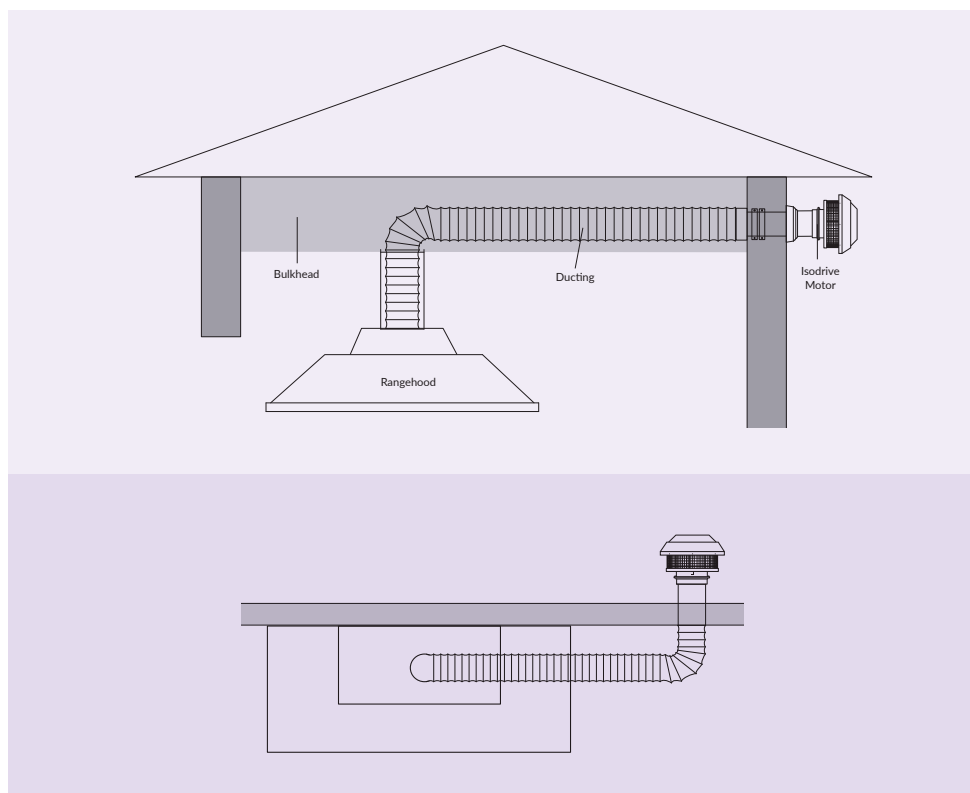

External wall mount examples. Please refer to the Isodrive® Motor manual for recommended ducting lengths. Images are for illustrative purposes only.

Condensation Information

COOKING WITH INDUCTION COOKTOPS

Cooking with an induction or similar cooktop, may produce condensation on the rangehood.

Unlike basic electric or gas cooking, induction cooktops heat food and liquid instantly, which in turn, produces vapours rapidly. Because of this rapid process the rangehood filters do not have enough time to warm, which increases the chance of condensation forming.

There are many variables that may contribute to condensation forming, some of which include but are not limited to:

- Variance in climate – geographical location.
- Position of your home & kitchen – morning/afternoon sun.
- Installation distance from cooktop to the rangehood.
- Speed of food and liquid heating.
- Filter size – larger canopy preferred.
- Quality of pots or cookware you are using – high quality recommended.

HOW TO REDUCE THE POSSIBILITY OF CONDENSATION FORMING:

- Ensure the rangehood is installed by a qualified professional, carefully following the installation guide.
- Turn on the rangehood 5–10 minutes prior to cooking, and leave on for 5–10 minutes after cooking; this helps clear remaining vapours from the flue.
- Start the cooking process at a low-to-medium setting and allow time for the rangehood to warm up.
- Clean filters regularly.
- Ensure constant airflow in the cooking zone; this helps optimise the rate of extraction.
- Follow all induction cooktop manufacturer advice.

For further advice, tips or information regarding cooking with induction, please contact your induction cooktop manufacturer.

TROUBLESHOOTING

IF THE PRODUCT DOES NOT WORK:

Before you contact the technical service department, make sure the product is plugged in, and electric wiring is connected. Weak air suction may be caused by back draft fins remaining closed. Do not take any action that will damage the product.

The below table lists a number of commonly reported faults and their causes. Please check the list below before lodging a service request

	Check electric connection. Voltage of the electric network should be between 220–240V; rangehood should be connected to grounded plug and turned on.	Check motor switch. Please ensure that there is power to the rangehood and the rangehood is switched on.	Check light switch. Light switch should be at the on position.	Check filter. Filter should be washed regularly, see filter cleaning.	Check lights. LED should be firm.	Check outlet. Outlet should be open.	Check light bulbs. Make sure they are not broken or faulty.	Please make sure there is no obstruction in ducting or back draft fins.
Rangehood does not work	X	X						
Light does not work	X		X		X		X	
Rangehood air suction is weak				X		X		
Rangehood does not direct air out (through chimney)				X				X

Troubleshooting

SERVICE

LOGGING AN ONLINE SERVICE REQUEST

In the event that the failure is not due to the faults mentioned in the Troubleshooting section, you can lodge an online Service Request.

To lodge an online Service Request, visit our website www.schweigen.com.au/service-and-warranty and click on the link and complete the service request form.

Alternatively, you can call Customer Service:

Australia 1300 881 693

New Zealand 0800 259 644

A service request will require the following information:

- The purchase date
- The rangehood model and motor type (eg. Isodrive® 1650)
- The serial number or batch number (this number is on a sticker inside the rangehood).
- A copy of the purchase receipt (without a receipt your service request cannot be processed).

FAULTY INSTALLATION

It is not the responsibility of Schweigen to rectify any incorrect installations. A service call out fee will be charged for any Schweigen technician that attends a call, where it is found that the fault is due to an incorrect installation or non-manufacturing fault. Should the appliance be installed in such a way that the service agent is unable to gain access to the appliance, the person/s who own the premises or the property where the appliance resides, will be responsible to provide access to the appliance at their expense.

DISCLAIMER

Under our policy of continuous product development, product specifications may change without notice. Prospective purchasers should therefore check with the retailer to ensure this publication correctly describes the products being offered for sale. All information supplied is to be used for general reference purposes only and is on the understanding that Schweigen Home Appliances will not be liable for any loss, liability or damage of whatever kind arising as a result of any reliance upon such information. All pictures used in the guide are for illustrative purposes only.

Although our information and marketing states the term 'Silent' for certain models, the following applies to various models that are sold with certain Isodrive® systems and baffles. When a model with the larger motored Isodrive® system is operated at the higher speed/s air movement may be heard. For example, while operating on speed 4 & 5 (For 5 speed models) the rangehood may be

audible due to the large amount of air movement moving through the filter.

*Please make sure that the rangehood and motor have been installed as per the corresponding instruction guides in order for optimal performance (the Isodrive® Motor Manual can be found with the Isodrive® Motor, or online at schweigen.com.au).

Schweigen Home Appliances has presented this information in good faith to all their retailers and distributors to convey before any/all purchase/s. Information is supplied upon the condition that the person/s receiving the information will make their own determination as to its suitability for their purpose/s prior to use. In no event will Schweigen Home Appliances be responsible for damages of any nature whatsoever resulting from the use of, or reliance upon, information from their website or the products to which the information refers.



DISPOSAL OF OLD APPLIANCES

Electronic waste (or e-waste) including kitchen appliances are banned from direct disposal to landfill. E-waste contains hazardous materials, which can harm the environment and human health. Valuable materials contained in e-waste are lost when appliances, computers and other household electrical goods are sent to landfill.

Recycle your e-waste to:

- reduce landfill
- protect the air and waterways from harmful materials
- minimise consumption of raw materials to produce electronic products
- reduce greenhouse gases created in the production of new materials.

Kitchen appliances including Rangehoods and Ovens can only be disposed at approved recycling centres. Visit www.recyclingnearyou.com.au/whitegoods for more information, or contact your local council or the store you purchased this appliance, for a list of approved recyclers.

Notes

© Schweigen Home Appliances Pty Ltd. 2025

Australia

Unit 4/1-5 Lake Drive, Dingley Village, Victoria 3172

Phone: 1300 881 693

Email: sales@schweigen.com.au

New Zealand

Ground Floor, 165 The Strand, Parnell, Auckland 1010

Phone: 0800 259 644

Email: servicerequest@schweigen.co.nz

schweigen

Distributed by Schweigen Pty Ltd.
53 124 141 322

**Scan for more
contact details**



Revision 8 14/05/2026