



# Tech Logic

## PRODUCT CATALOG

### **Tech Logic Corporation**

835 Hale Avenue North  
Oakdale, MN 55128

[www.tech-logic.com](http://www.tech-logic.com)

[info@tech-logic.com](mailto:info@tech-logic.com)

(800) 494-9330



## Celebrating nearly 30 years working exclusively with libraries

We know that part of your mission as a library leader is to automate circulation tasks so that your library's staff and patrons can focus on what's most important.

Bob Rolfe (former director of the Hennepin County Library in Minnesota) had this in mind when he co-founded Tech Logic in 1997. Under his leadership, we produced North America's first library-specific automated material handling (AMH) system. To this day, our success is tied directly to the success of our library partners and with the library industry as a whole.

Tech Logic provides solutions that automate workflows throughout the library. Because we focus exclusively on library technology, we bring a level of customization and service to libraries that inspires our customers to choose us year after year.

In 2005, The Library Corporation (TLC) became our parent company. TLC has been a US-based and family-owned company (certified WOSB) since its founding in 1974. For over 50 years, TLC has provided solutions for all kinds of libraries—from single sites to the largest systems in the world.

Because Tech Logic has gone all in on our niche in the library industry, we have the dedicated bandwidth to truly consult with each of our existing and prospective library partners. We would welcome the opportunity to continue this conversation with you and, ultimately, to partner with you in your mission to empower your library and your community.

Sincerely,

Gary Kirk | President | Tech Logic Corporation  
gkirk@tech-logic.com

# totalAMH

Automated Material Handling (AMH)  
Designed Exclusively for Libraries since 1997



Tech Logic's totalAMH solutions are custom-built automated material handling (AMH) systems that are transforming library circulation workflows for both staff and patrons. Since 1997, Tech Logic's totalAMH designs have been constantly tested, refined, and proven in the library industry. With your new system, you should expect benefits like the following:



## EMPOWER YOUR PEOPLE

With totalAMH, patrons and staff simply induct handful-sized stacks of items into the system and then walk away. Our patron returns and staff induction systems reduce induction time and motion by 50-70% (as compared to a manual one-at-a-time induction workflow).

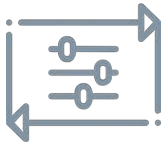

## STAY FLEXIBLE

Staff can easily monitor totalAMH system operations and make configurations accordingly. For example, staff can create as many different sorting strategies as they need and switch between them on the fly to address various library goals and scenarios.



## AUTOMATE FOR THE LONG TERM

Tech Logic's totalAMH systems are built to last, and our service team is dedicated to protecting your investment. We have been maintaining and supporting AMH systems since 1997. Some of those first systems are still serving their libraries today, having sorted tens of millions of items.



## OUR SYSTEMS ARE COMPLETELY CUSTOMIZABLE

We've installed small three-bin totalAMH systems, as well as 70-bin totalAMH central sorters. We've installed totalAMH systems with customized conveyance and configurations for multi-floor buildings and varying workflows. We would love to hear about your library design and goals. We'll work with you to create a customized totalAMH solution.

### AUTOMATED INDUCTION FOR PATRONS

With totalAMH, patrons simply induct handful-sized stacks of items into the return and then walk away. No tedious manual one-at-a-time scanning is required.

### AUTOMATED INDUCTION FOR STAFF

With totalAMH, staff simply induct handful-sized stacks of items onto the staff induction conveyance and then walk away. No tedious manual one-at-a-time scanning is required.

### AUTOMATIC MATERIALS SEPARATION

Unlike competitors, Tech Logic's stack separation design has been proven and refined in hundreds of libraries throughout the last 25+ years.

### AUTOMATIC CHECK-IN AND SORTING

Immediately after separation, totalAMH uses RFID and/or barcode technology to detect, identify, check-in, and sort each item based on connection to the library's circulation system and the library's sorting strategy.

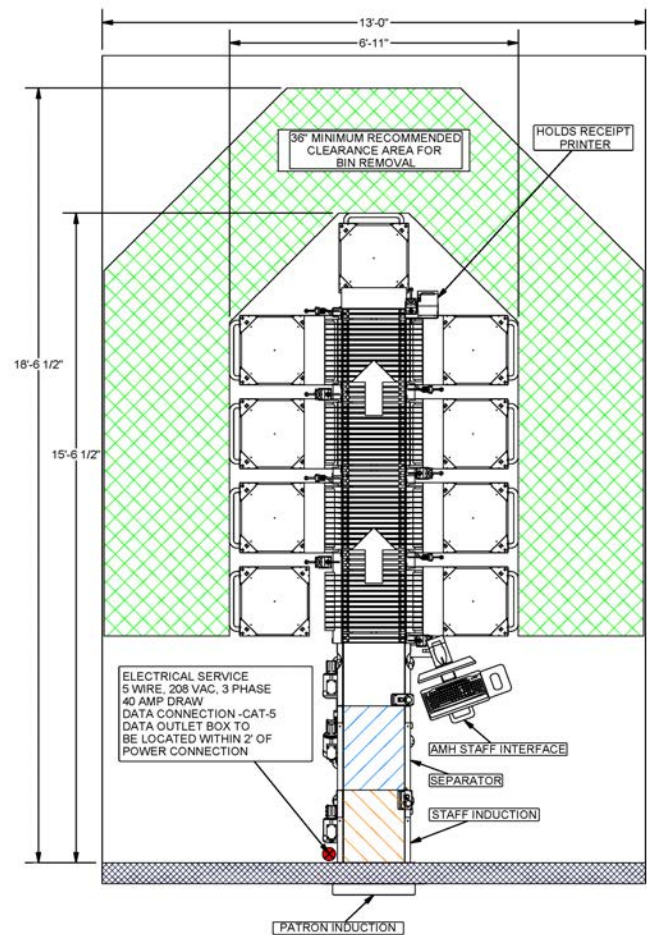

### STREAMLINED CENTRAL MANAGEMENT

From the totalAMH system's central PC (Windows IoT Enterprise LTSC) staff can access statistics, monitor each conveyor section, see when containers are full, troubleshoot any errors, create and switch between sort strategies, and more.

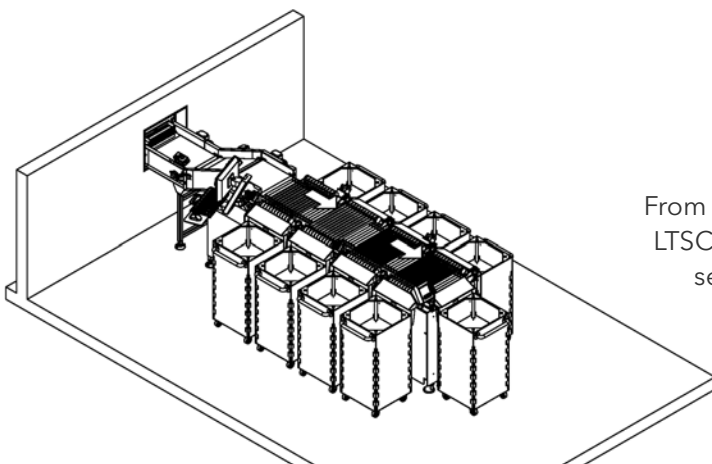



## OUR EXCEPTION CONTAINER WORKS FOR YOU

Rather than forcing patrons or staff to interrupt item induction in order to deal with rejected items (e.g. damaged or missing RFID tag) our totalAMH system accepts these items and sorts them into a designated exceptions bin for investigation at a staff member's convenience.



*totalAMH systems can work with a mix of various containers depending on the library's desired sorting strategies.*

## BARCODE DETECTION (OPTIONAL)

Libraries deploy our totalAMH VISION system (shown below) if some or all of their items only use barcodes. This system detects each item's barcode from above or below the conveyance, no matter the item's orientation, using machine vision technology.



## FLEXIBLE SORTING CONTAINERS

Tech Logic's easyBINS, smartBINS, totes, and tote carts serve as reliable and ergonomic tools to complete the totalAMH workflow.

Our totalAMH systems work with a variety of sorting containers—whether or not the containers are provided by Tech Logic.

## AUTOMATED CONTAINERS (OPTIONAL)

Tech Logic's automated smartBIN containers (shown below) are designed for the best ergonomic experience. For efficient loading, unloading, and transport, smartBINS use oversized wheels and photo sensors that automatically adjust the bin floor when items are added or removed.

*smartBIN  
dimensions  
(below)*

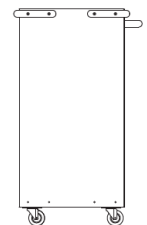
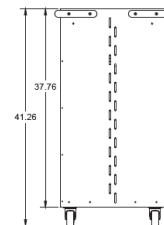
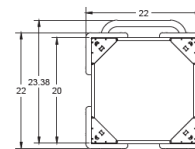
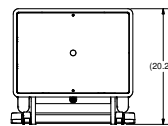

*easyBIN  
dimensions  
(above)*

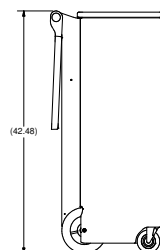
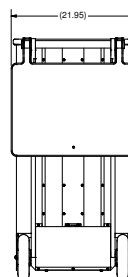



### BATCH TRANSIT (OPTIONAL)

Tech Logic's batchTRANSIT system can log a group of sorted items under one container's barcode so that, when that container travels from one destination to another, the container (and the items) are tracked in a database and staff have the option to process all of the items simultaneously with a single scan.

Also, with all of these items tracked within the batchTRANSIT database, staff can easily search for specific containers or items and can also obtain item transit statistics—all from any PC or tablet with access to the library network.

### AUTOMATIC ITEM INDUCTION (OPTIONAL)

Our totalAMH UNLOADER system (shown below) is ideal for high-volume operations, because it gently and automatically unloads full smartBINS onto the totalAMH system without a staff member having to touch any items.



*"Tech Logic was able to provide input during the design process regarding all the different components so the team could arrive at an efficient and effective solution for the Lenexa City Center Library."*

– Project Architect

### CUSTOMIZED CONVEYANCE (OPTIONAL)

Tech Logic's custom conveyance systems, designed specifically for library items, have set the standard in the library industry. Our patented and proven systems gently transport library items around corners, under floors or streets, to or from separate building levels, overhead via ceiling conveyance, and more.

### CALLING ALL LIBRARY DESIGNERS AND PLANNERS

Tech Logic's AMH portfolio is the most flexible in the industry because we prioritize collaboration and customization. It's never too early to connect with us about your automation project.



# easyBIN

---

GENTLE, RELIABLE SORTING



Tech Logic's easyBIN, made with galvanized steel, is tough on the outside but gentle on items.

The easyBIN's padded float tray lowers as items are received and rises as items are removed, which keeps items near the top of the bin. This keeps items from falling too far upon induction and also helps to eliminate strain on the user's back and shoulders during retrieval.

Our easyBIN holds between 125 and 150 items (depending on item size) and comes with lockable wheels, ready for versatile use throughout the library's sorting operation.

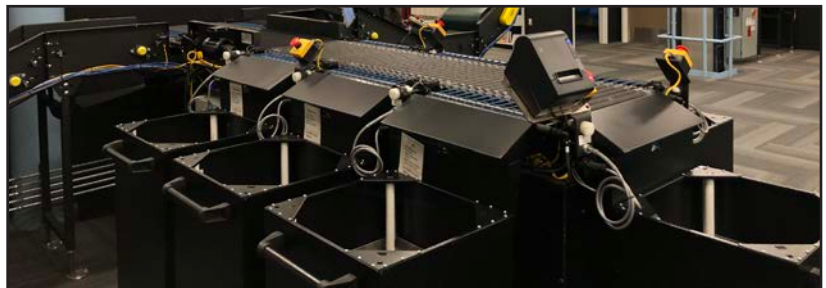

Tech Logic's totalAMH system works with a variety of containers—whether or not the containers are purchased through Tech Logic.



## easyBIN (totalAMH Sorting Container Option)

<b>Dimensions</b>	Please find dimensions, below.
<b>Item Capacity</b>	125-150 Items
<b>Floor Adjustment</b>	Padded, spring-loaded base for gentle loading and ergonomic unloading
<b>Wheels</b>	Four corner-located casters. Two swivellocking casters and two fixed casters. Nonmarring. Plate mounted. Ball bearing
<b>Construction</b>	Galvanized Steel. 14-gauge gusseted base, riveted seams with bottom access

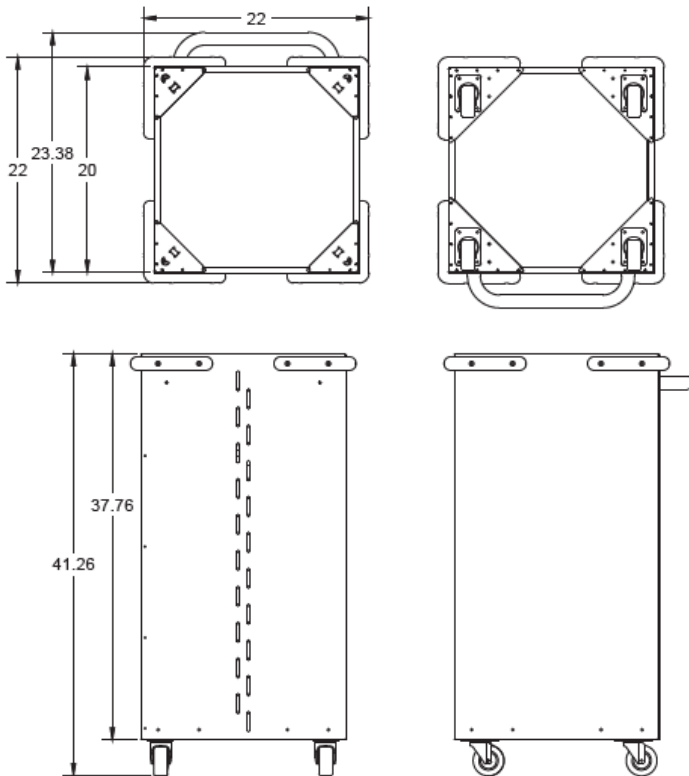
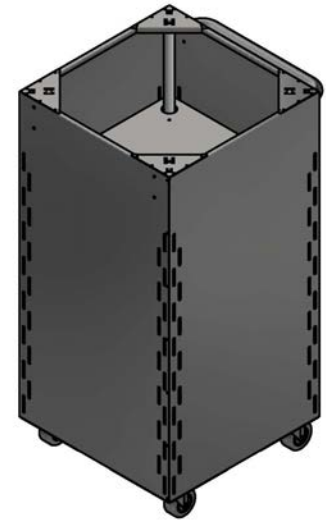

## smartBIN

STREAMLINED SORTING AND TRANSIT

Tech Logic's automated smartBIN containers are designed for the best ergonomic experience.

For efficient loading, unloading, and transport, smartBINS use oversized wheels with locking brakes. Automated sensors adjust the bin floor when items are added or removed.



With optional lids and batteries (for powered automation while away from the sorting system) smartBINS are ready for branch and central sorting, transit operations, and other varied workflows across the library.

***Our totalAMH UNLOADER system (left) is ideal for high-volume operations,*** because it gently and automatically unloads full smartBINS onto the AMH system without a staff member having to touch any items.

Tech Logic's totalAMH system works with a variety of containers—whether or not the containers are purchased through Tech Logic.



Check out Tech Logic's YouTube channel to see our smartBIN and totalAMH UNLOADER at work! [www.youtube.com/watch?v=M22XPoDCvZ0](https://www.youtube.com/watch?v=M22XPoDCvZ0)



## smartBIN (totalAMH Sorting Container Option)

<b>Dimensions</b>	Please find dimensions, below
<b>Item Capacity</b>	125-150 Items
<b>Floor Adjustment</b>	Automatic raising or lowering based on items inducted or removed; Manual override included
<b>Power/Data</b>	Connects to totalAMH system during sorting operation. Away from totalAMH, automation powered by battery (optional)
<b>Wheels</b>	Large, durable, polyurethane wheels designed for travel indoors or outdoors Locking brake system
<b>Options</b>	Lid (for weather protection) Battery (for powered automation away from totalAMH system) Unloader (for automated induction of full smartBIN onto totalAMH system)

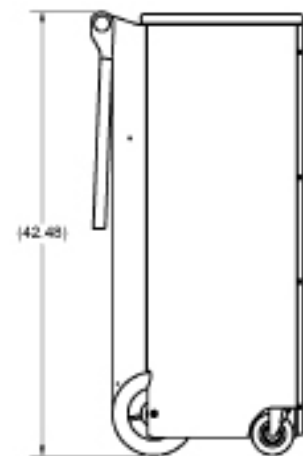
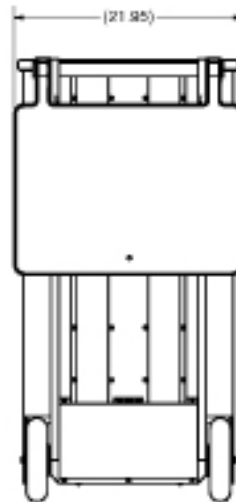
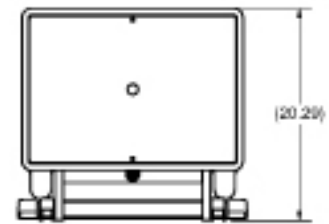
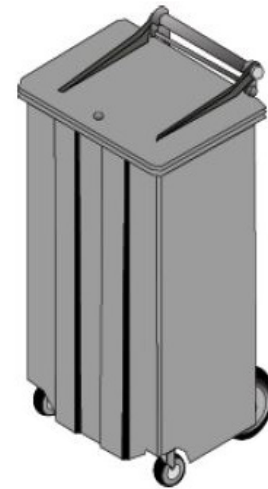

# toteCART

VERSATILE TOTE MANAGEMENT



Tech Logic's toteCART, made with powder-coated steel, is designed for versatile use with totes at the sorter and beyond.

Tech Logic's totalAMH system works with a variety of containers—whether or not the containers are purchased through Tech Logic. Depending on the library's sort strategy, library staff can adjust the system to use various containers (i.e. bins or totes) at different sort locations.

If the library decides to use totes for some or all of their sort locations, the toteCART keeps one tote at the proper height for gentle sorting, and another tote below for easy swapping.

Our toteCART comes with lockable wheels, ready for versatile use throughout the library's sorting operation.





## toteCART (totalAMH Sorting Container Option)

<b>Handle</b>	Moving handle adjusts to carrier's height
<b>Shelving</b>	Two shelves; one shelf keeps a tote at the proper height for gentle sorting, and another shelf keeps a tote below the first for easy swapping
<b>Wheels</b>	Four corner-located casters. Two swivel-locking casters and two fixed casters. Nonmarring. Plate mounted. Ball bearing
<b>Construction</b>	Powder-Coated Steel

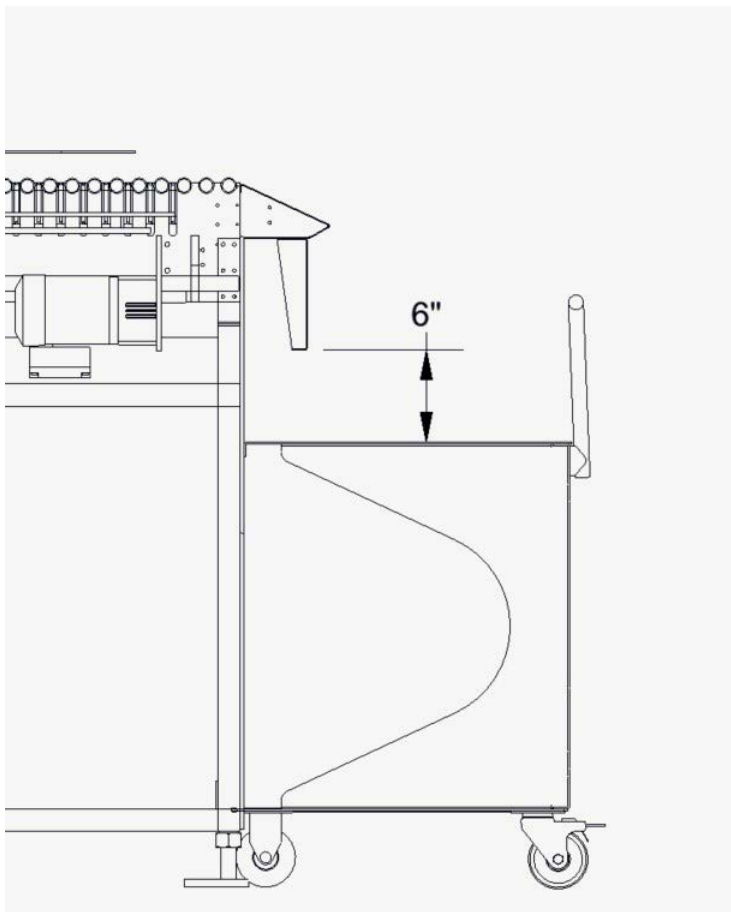

# baseCAMP

Manage Tech Logic Solutions from One Web-Based Portal



baseCAMP empowers our customers to manage their Tech Logic systems from any PC or tablet with library network access.

*Thank you, customers, for baseCAMP's platinum-level ratings!*



**Log in anywhere.** Library staff can log in to the baseCAMP interface from any PC or tablet with access (or remote access) to the library network. From there, staff can enjoy the benefits of baseCAMP's configuration, monitoring, and reporting features for Tech Logic systems.

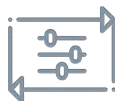

## CONFIGURATION

baseCAMP allows staff to configure selfCIRC, staffCIRC, and rfidGATE solutions at the library system, branch, or terminal level—for fast and easy deployment.



## MONITORING

With baseCAMP, staff can manage selfCIRC LOCKER and rfidGATE operations throughout the day, streamlining circulation and patron engagement.



## REPORTING

baseCAMP allows staff to create statistical reports—by activity, date, time, branch, terminal, and more—for key insights into library performance and patron experience.



### NETWORK STATUS

If a baseCAMP-connected device is offline for any reason, the baseCAMP interface will provide a visual alert within the web-based interface.



### CONTROLLED ACCESS

Team leaders can set visibility and permissions for each library staff member based on user role, library branch, baseCAMP functionality, and more.



### FASTER SUPPORT

With configs and data consolidated within the baseCAMP portal, both Tech Logic staff and library customers enjoy streamlined insights and faster fixes.

**baseCAMP** Home Reporting batchTRANSIT selfCIRC Lockers Gate Monitor Administration Hello, mfinnerr@tech

2 Offline Devices

- Oakdale Library SalesDemoPrime2 Device Offline
- Tech Logic Public Library Show Sorter Device Offline

#### Tech Logic Library System - 3/19/2024

##### My Totals for Today

<b>Checkins</b> 38	<b>Checkouts</b> 1,038	<b>Payments</b> \$108	<b>Reserved Lockers</b> 1 of 13
<b>People In</b> 391	<b>People Out</b> 392	<b>Alarms</b> 26	<b>Sorted Items</b> 9496

##### My Day at a Glance

Legend: Checkins (blue), Checkouts (purple), Patron Sessions (green), Failed Authentications (red)

Legend: People In (green), People Out (yellow), Occupancy (purple), Alarms (red)

baseCAMP's home dashboard provides centralized navigation, at-a-glance reports, and fast notification of any detected issues. Each user's interface will automatically change to fit that user's permission settings.



baseCAMP Home Reporting batchTRANSIT selfCIRC Lockers Gate Monitor Administration Hello, mfinnerr@tech-logic.com

Library System  
Oakdale Library  
Sales Blue Metal Lockers

Print Locker Manifest Search by Item or Patron ID:  GO

Scan or Enter Item ID for Reservation:  GO

### Sales Blue Metal Lockers

#### Locker 1

Locker Status: Available

Last Reservation  
Patron ID: 123456  
Reservation Items: 01  
Reserved At: 2/1/2024 2:14 PM  
Items Delivered At: 8/3/2023 2:33 PM

1 Available	6 Available
2 Available	7 Available
3 Available	8 Available
RETURNS	9 Available
	10 Available
	11 Available
	12 Available
	13 Available
	14 Available

Manage your holds pickup lockers, self-check stations, security gates, and more from any PC or tablet with access (or remote access) to the library network.

baseCAMP Home Reporting batchTRANSIT selfCIRC Lockers Gate Monitor Administration Hello, mfinnerr@tech-logic.com

Library System  
Generic Public Library Branch  
Test Gate  
Tech Logic Public Library  
Main Entrance

Current Item Alarms  Enable Audible Alerts on this Workstation

Library	Security Gate Name	Item ID	Title	Circulation Status
Generic Public Library Branch	West Entrance Gates	39677200413672	The Goonies	Available
Woodbury Library	Children Area Entrance	39677200413672	The Goonies	Available
Generic Public Library Branch	Main Entrance Gates	39677200413672	The Goonies	Staff Override
Generic Public Library Branch	West Entrance Gates	39677200413672	The Goonies	Staff Override
Woodbury Library	Children Area Entrance	39677200413672	The Goonies	Available
Generic Public Library Branch	Main Entrance Gates	39677200029528	A History Of The English Speaking Peoples	Charged
Generic Public Library Branch	Main Entrance Gates	39677110651502	The Moral Vision Of Dorothy Day : A Feminist Persp	Available
Tech Logic Public Library	Main Entrance	12345000000997	There There	Missing
Tech Logic Public Library				
Tech Logic Public Library				

Monitor and address security gate alarms from any network-connected PC or tablet. Upon alarm, receive a visual and (optional) auditory alert and see each item's title, ILS status, and other information immediately from the interface.



baseCAMP Home Reporting batchTRANSIT selfCIRC Lockers Gate Monitor Administration Hello, mfinn@tech-logic.com

Administration Automated Material Handling batchTRANSIT Lockers Payments Security Gates Self-Checkout

Report From 3/19/2024 To 3/19/2024 Quick Dates No Report Selected Export to Excel Export to PDF

Library System  
 Cedar Hill Library  
 Demo Branch  
 baseCAMP Demo  
 Staff Station 1  
 Generic Public Library Branch

**Reporting**

Select a category of what type of reports you are interested in. You can then select which branches or specific components from that category to include in the report.

You can also choose the starting and ending dates of what data you would like to include in the report by clicking the button next to the **Report From** and **To** dates above.

**Quick Dates** allows choosing from a set of predefined date ranges such as **Yesterday**, **Last Month** and **This Year**.

The **Select Report** menu provides a list of available reports for the selected category.

After changing date ranges or included components in the report, click **Update Report** to refresh the current report to include those changes.

Current Report: No Report Selected

Select Report

- Item Summary
- Checkout Total
- Patron Sessions

Create, configure, and export statistical reports—all in one place.

baseCAMP Home Reporting batchTRANSIT selfCIRC Lockers Gate Monitor Administration Hello, mfinn@tech-logic.com

Administration Automated Material Handling batchTRANSIT Lockers Payments Security Gates Self-Checkout

Date filtering is not used by this report. Update Report Export to Excel Export to PDF

Current Report: Library System Summary

Select Report

**Library System Summary** Generated at 3/19/2024 3:00PM

Tech Logic Library System	
# of Branches	11
circIT SCO Licenses	54
circIT STAFF Licenses	3
selfCIRC Locker Licenses	1
staffCIRC TRAK Licenses	4
Total # of Terminals	75
# of ACS Terminals	13

Cedar Hill Library	Computer Name	Type
SalesDemoPRIME	SalesDemoPrime	selfCIRC PRIME

Demo Branch	Computer Name	Type
baseCAMP Demo	DESKTOP-VKKT78M	selfCIRC COMBO
Staff Station 1	Staff Station 1	staffCIRC PRO

Generic Public Library Branch	Computer Name

Gain valuable insights on licensing, system performance, patron experience, circulation, and more.

## baseCAMP Deployment

Looking for technical requirements? Let us know! We'll work with you to select the best baseCAMP deployment option to fit your goals and scenario.

# selfCIRC LOCKER

ILS-INTEGRATED HOLDS PICKUP

Tech Logic's selfCIRC LOCKER integrates directly with your ILS as an additional holds pickup location within the catalog.

Communicating with selfCIRC LOCKER, the library's ILS updates item statuses automatically when items are placed in the locker and again when they are retrieved by patrons.

With ILS integration, customizable wraps, and web-based management, selfCIRC LOCKER is ready to extend holds delivery to patrons throughout your community.



*Customize your  
selfCIRC LOCKER!*



## ILS INTEGRATED

selfCIRC LOCKER is simply another pickup location available in the catalog. Item statuses automatically update in the ILS.



## INSIDE AND OUTSIDE

selfCIRC LOCKER is approved for indoor and outdoor use, as long as it's placed away from direct precipitation.



## WEB-BASED CONTROL

Manage selfCIRC LOCKERS from any PC or tablet with access (or remote access) to the library network.



# ILS-Integrated Workflow

Communicating directly with selfCIRC LOCKER, the library's ILS is in charge of circulation rules, item statuses, item checkout (when the patron retrieves their items from the locker), and corresponding patron due dates and notifications.



## **1. Patrons place holds as usual, selecting the locker as their pickup location.**

Patrons place holds through the library's catalog and simply select the locker as their pickup location. If a patron needs easier access to a locker space, selfCIRC LOCKER can reserve an ADA-accessible "easy-reach" locker space.

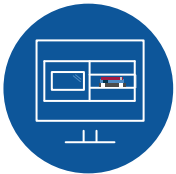

## **2. Staff members process holds from any network-connected PC or tablet.**

From any network-connected PC or tablet, staff members scan holds into the web-based locker interface. The selfCIRC LOCKER system automatically reserves locker space for the hold items. If any existing holds within the locker have expired, that locker space will be reassigned to a new hold. If a patron already has existing holds within a locker space, selfCIRC LOCKER will add new items to that patron's locker space.



## **3. selfCIRC LOCKER provides an item list so staff can stock the locker easily.**

A staff member can bring the manifest to the lockers in order to remove expired holds and stock new holds. The courier can also pick up returns, if the library's locker system includes a return bin.



## **4. When hold items are ready for pickup at the locker, the ILS notifies patrons.**

When couriers have placed items within their assigned locker spaces, the ILS updates item statuses to "on hold" and notifies patrons in the same way it would for any other hold. The library decides how long items in the locker remain on hold.



## **5. When patrons scan their barcode at the locker, their locker space opens and the ILS checks their items out automatically.**

Loan periods, patron communications, and other circulation rules are managed by the ILS, as with any other holds in the library.



# Web-Based Management

Through baseCAMP, Tech Logic’s web-based management portal, staff can manage each of their locker locations from any network-connected PC or tablet. Staff can process items, manage courier manifests, view statistics, search for specific items or patron IDs, remotely open locker spaces, and more.

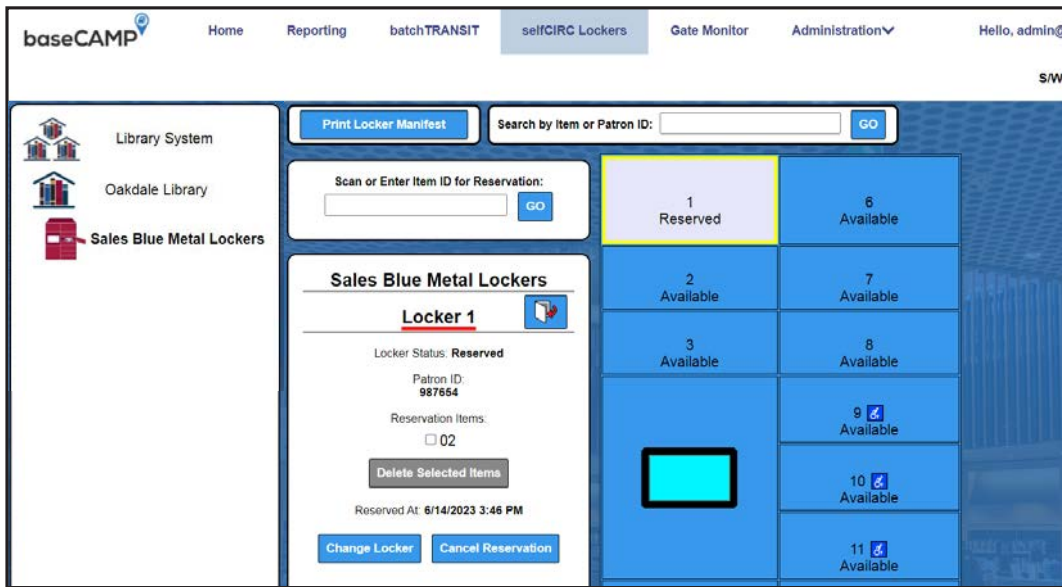

# Flexible Design

**Every selfCIRC LOCKER includes an awning, a security camera, and an Access Cabinet** (includes a touchscreen, a barcode scanner, and up to 23 locker spaces)

- **Add Locker Cabinets** (each cabinet provides 28 more locker spaces)
- **Add custom vinyl wrapping** to showcase your brand, if desired
- **Add an item return box** to the Access Cabinet, if desired
- **Add extra climate control** (heat or AC) if desired

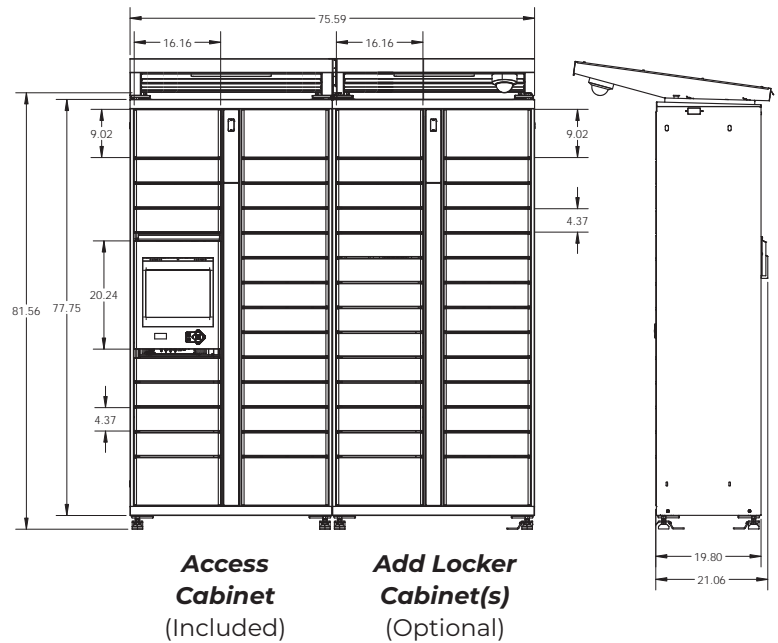



# selfCIRC LOCKER Specifications

<b>Flexible Locker Configurations</b>	<p><b>Every selfCIRC LOCKER comes standard with an Access Cabinet, awning, and security camera.</b></p> <p><b>Access Cabinet:</b> Includes a touchscreen, barcode scanner, and 23 locker spaces (18 spaces if the library opts for an item return box)</p> <p><b>Add up to two (2) additional Locker Cabinets:</b> Each additional Locker Cabinet provides 28 more locker spaces</p> <p><b>Add custom vinyl wrapping, an item return box, and/or extra climate control (AC and/or heater unit)</b></p>
<b>Hardware Construction</b>	Galvanized steel, all welded.
<b>Touchscreen</b>	Screen Size: Diagonal 15" Brightness: 450 NIT (1000 NIT also available) Projective Capacitive (PCAP)
<b>Operating System</b>	Windows 11 Enterprise IoT LTSC (maximum stability and longevity)
<b>Power</b>	120 VAC 60 HZ AC Power outlet (NEMA 5-15R) Electrical draw per Access Cabinet: 3 AMP (Locker Cabinets not plug-connected) GFCI protected outlet (according to local code) Bottom of AC Power outlet installed 90" (min) above floor level (ideal)
<b>Data</b>	Ethernet (CAT5E or better) for network connection
<b>Color/Wrapping</b>	Standard: White Pantone #401C. Custom vinyl wrapping available
<b>Environmental Requirements</b>	<p><b>Approved for indoor or outdoor use.</b> Locker compartments are weather resistant (rated IP34) with strong water control channeling, and the OS compartment is weathertight (rated IP54) Lockers should always be placed out of direct precipitation (e.g. under a three-walled shelter or building overhang)</p> <p>Operating Temp: 32F-104F (additional AC and/or heater units are also available to accommodate extreme temperature conditions)</p>
<b>Web-Based Management</b>	Web-based management via Tech Logic's baseCAMP central management portal from any network-connected PC or tablet
<b>Barcode Scanner</b>	Code 39, Code 128, Codabar symbology
<b>Awning</b>	Awning included with automatic LED lighting and security camera
<b>Certifications</b>	UL certification pending

# selfCIRC PRIME

PATRON SELF SERVICE

selfCIRC PRIME brings a customizable and streamlined self-service solution to your library patrons. With flexible form factors as well as paint and graphic wrapping options, selfCIRC PRIME is ready to optimize your desired workflow and branding experience.

With a customizable software interface that showcases your desired branding, workflow, and web-based signage and applications, selfCIRC PRIME will engage patrons with streamlined self service and much more.



Pictured:  
selfCIRC PRIME  
standalone/  
pedestal unit  
(includes shelf)  
with credit/debit  
payment unit



## UNIQUELY YOURS

Every aspect – from the color of the unit to checkout screenflow and more – can be customized to meet your library's goals.



## PROMOTE PROGRAMS

With digital signage and applications, you can be sure to engage with each patron using self-service stations.



## DEVICE MANAGEMENT

Changes can be applied system wide, branch wide, or at the terminal level – all from a central web-based portal.



## selfCIRC PRIME Standalone Kiosk

<b>Kiosk Dimensions</b>	H: 62.0"      W: 40.3"      D: 19.0" w/ RFID antenna
<b>Kiosk Weight</b>	150 lbs.
<b>Power</b>	110v AC
<b>Data</b>	RJ-45 Ethernet
<b>Touchscreen</b>	22" LED touchscreen (portrait orientation) 16:9 aspect ratio Projective capacitive touchscreen
<b>PC</b>	Windows 11 IoT Enterprise LTSC 64-bit Intel i-3, 8G RAM, 128GB SSD
<b>Shelf (Included)</b>	Attachable shelf for holding patron's extra items is included at no extra charge
<b>RFID Equipment</b>	13.56 HMz HF Reader (1w) ISO 15693, ISO 18000-3 Multi-item capacity
<b>Barcode Scanner</b>	2-D imager, Smartphone enabled All library barcode symbologies
<b>Receipt Printer</b>	High speed, 80mm thermal printer Full/partial cut options
<b>Credit/Debit Payment</b> <i>*Optional</i>	VeriFone, Comprise
<b>Cash/Coin Payment</b> <i>*Optional</i>	Jamex Payment Unit
<b>Unit Color Options</b>	Stock and custom Pantone powder coating available Custom vinyl wrapping available
<b>Reporting and Mgmt</b>	Centralized administrative reporting and management included via Tech Logic's central web-based application—baseCAMP
<b>Software</b>	Powered by circIT SUITE

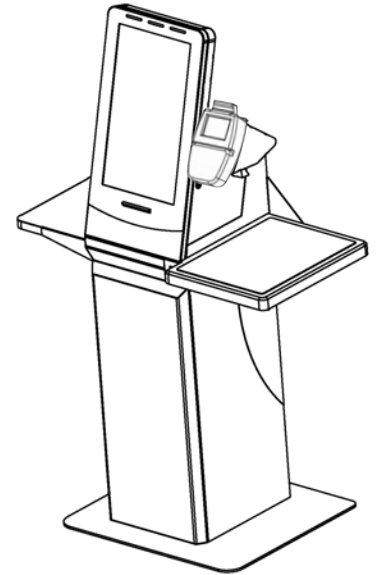



## selfCIRC PRIME Desktop Kiosk

<b>Kiosk Dimensions</b>	H: 27.4"      W: 28.3"      D: 19.0" w/ RFID antenna
<b>Kiosk Weight</b>	72 lbs.
<b>Power</b>	110v AC
<b>Data</b>	RJ-45 Ethernet
<b>Touchscreen</b>	22" LED touchscreen (portrait orientation) 16:9 aspect ratio Projective capacitive touchscreen
<b>PC</b>	Windows 11 IoT Enterprise LTSC 64-bit Intel i-3, 8G RAM, 128GB SSD
<b>RFID Equipment</b>	13.56 HMz HF Reader (1w) ISO 15693, ISO 18000-3 Multi-item capacity
<b>Barcode Scanner</b>	2-D imager, Smartphone enabled All library barcode symbologies
<b>Receipt Printer</b>	High speed, 80mm thermal printer Full/partial cut options
<b>Credit/Debit Payment</b> <i>*Optional</i>	VeriFone, Comprise
<b>Cash/Coin Payment</b> <i>*Optional</i>	Jamex Payment Unit
<b>Unit Color Options</b>	Stock and custom Pantone powder coating available Custom vinyl wrapping available
<b>Reporting and Mgmt</b>	Centralized administrative reporting and management included via Tech Logic's central web-based application—baseCAMP
<b>Software</b>	Powered by circIT SUITE

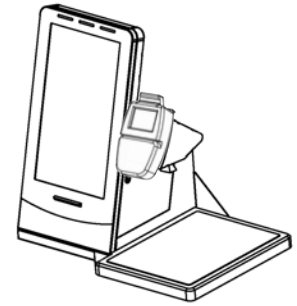



## Optional Pedestals for selfCIRC PRIME Desktop Kiosk

<b>Kiosk Dimensions w/ Pedestal and Shelf</b>	Standard	H: 61.7"	W: 40.3"	D: 19.0" w/ RFID antenna
	ADA	H: 55.8"	W: 40.3"	D: 19.0" w/ RFID antenna
	Adjustable	H: 55.4-61.4"	W: 40.3"	D: 19.0" w/ RFID antenna
<b>Kiosk Weight w/Pedestal and Shelf</b>	Standard	161 lbs. (Kiosk + Pedestal)		
	ADA	144 lbs. (Kiosk + Pedestal)		
	Adjustable	191 lbs. (Kiosk + Pedestal)		
<b>Power</b> <i>*Adjustable Only</i>	110v AC			
<b>Height Adjust Switch</b> <i>*Adjustable Only</i>	Single-touch toggle switch provides gentle, gradual adjustment			
<b>Shelf (Included)</b>	Attachable shelf for holding patron's extra items is included at no extra charge			
<b>Unit Color Options</b>	Stock and custom Pantone powder coating available Custom vinyl wrapping available			
<b>Secure Connection to selfCIRC PRIME Kiosk</b>	Eight (8) secure connection bolts per unit			

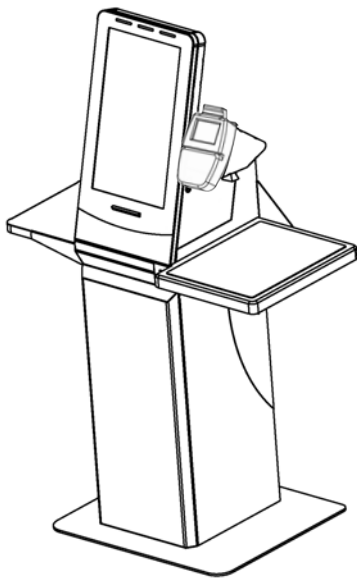

Standard Pedestal

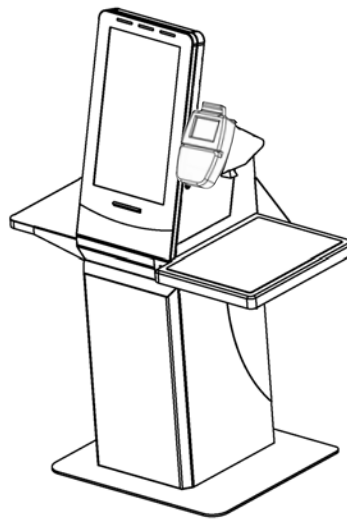

ADA Pedestal

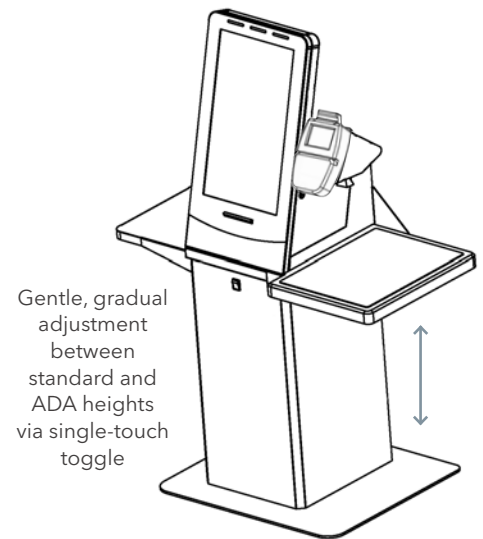

Gentle, gradual adjustment between standard and ADA heights via single-touch toggle

Height-Adjustable Pedestal

# selfCIRC FOCUS

STREAMLINED SELF-SERVICE

The selfCIRC FOCUS is a high-impact self-check solution with an efficient hardware deployment.

With streamlined desktop and freestanding form factors, the selfCIRC FOCUS minimizes footprint and centers on the patron's experience.

Powered by our circIT SUITE software, all selfCIRC units showcase your desired branding, workflow, URL-based signage, URL-based apps, and more.



## MINIMAL FOOTPRINT

With a light, streamlined aesthetic, the selfCIRC FOCUS is centered around circIT SUITE's robust digital UX rather than expensive housing.



## PROMOTE PROGRAMS

With digital signage and flexible applications, you can engage with patrons automatically using the self-service interface.



## DEVICE MANAGEMENT

Apply configurations system-wide, branch-wide, or down to the terminal level from baseCAMP, our central web-based application.



Dimensions	Desktop: H-25" D-14" W-32" Freestanding: H-53" D-14" W-44"
Power	110v AC
Data	RJ-45 Ethernet
Touchscreen	21.5" touchscreen Portrait Mode Projective capacitive touchscreen
Operating System	Windows 11 IoT Enterprise LTSC
Software	Powered by circIT SUITE
Reporting and Mgmt	Centralized administrative reporting and management included via Tech Logic's central web-based application—baseCAMP
Extra Shelving	Built-in shelf included as standard with freestanding unit
RFID Equipment	13.56 HMz HF Reader ISO 15693, ISO 18000-3 Multi-item capacity
Barcode Scanner	2-D imager, Smartphone enabled All library barcode symbologies
Receipt Printer	High speed, 80mm thermal printer Full/partial cut options
Credit/Debit Payment* *Optional	VeriFone, Comprise
Unit Finish Options	Black pantone powder coating
Compliance	UL/EN/IEC 62368-1   FCC   RoHS (2011/65/EU and (EU) 2015/863)   REACH (REGULATION (EC) No 1907/2006)



## Looking for more information?

Do you want to talk with a solutions specialist about your library's needs? We're here to help.



# selfCIRC PRO

PATRON SELF-SERVICE



selfCIRC PRO is our most popular, most easily deployed, and most cost-effective patron self-service solution.

This component-based solution can include all required equipment: PC, touchscreen, receipt printer, barcode scanner, and RFID antenna (if needed). Alternatively, the library is welcome to provide its own peripheral hardware and Tech Logic can provide the software and, if needed, RFID equipment.

Powered by our circIT SUITE software, all selfCIRC units can showcase your desired branding, workflow, URL-based signage, URL-based apps, and more.



## EXISTING EQUIPMENT

The library is welcome to provide any of its own hardware (e.g. receipt printers, PCs), as long as the hardware meets minimum specifications.



## PROMOTE PROGRAMS

With easy customization of digital signage and applications, you can be sure to engage with each patron using the self-service interface.



## DEVICE MANAGEMENT

Changes can be applied system-wide, branch-wide, or down to the terminal level from baseCAMP, our central web-based application.



## Considerations for RFID High-Frequency Antennas

Whether you're deploying RFID for staff workstations or for a self-checkout solution, Tech Logic has the right RFID High-Frequency (HF) antenna for your scenario.

Different antennas bring different benefits. It's all about choosing the right feature combination for each use case throughout the library. You'll want to consider...



**FOOTPRINT** | Conserving desk space may be an important part of your overall decision, depending on each use case.



**SHIELDING** | A shielded antenna keeps the high-frequency field contained in a vertical range above the antenna, preventing unwanted RFID detection below and beside the antenna. It also helps prevent detuning if the antenna is stationed on a metal surface.



**READ RANGE** | How many library items can you stack on the antenna for simultaneous processing? That depends on the antenna's read range! The antenna's read range also depends on other factors like the kinds of library items in your stack.

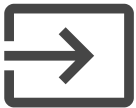

**READER INTEGRATION** | On some antenna options, the reader is built into the antenna's housing for a consolidated, one-piece deployment. On other options, the reader is a separate component.



# RFID High-Frequency Antenna Options

When it comes to an antenna’s footprint, shielding, read range, and reader integration, different feature combinations fit different scenarios throughout the library.

Tech Logic offers three antenna options. All of these antenna options work directly with Tech Logic’s software for circulation workflows across the library operation.



	<b>SPAD102</b>	<b>PAD74</b>	<b>ANTS240/180</b>
<b>FOOTPRINT</b>	14.8in x 10.0in x 1.1in	9.45in x 7.09in x 0.51in	9.45in x 7.09in x 0.59in
<b>SHIELDING</b>	Shielded	Unshielded	Shielded
<b>READ RANGE</b>	Up to 12 inches	Up to 7 inches	Up to 7 inches
<b>READER INTEGRATION</b>	Integrated reader	Integrated reader (Entire PAD74 unit is powered by one USB)	Non-integrated reader (Still included with purchase price)
<b>SUMMARY</b>	This option offers an integrated reader and a shielded antenna (if you don’t mind a larger footprint)	This option offers a smaller footprint, one-cord USB power, and an integrated reader (if you don’t mind an unshielded antenna)	This option offers a smaller footprint and a shielded antenna (if you don’t mind a non-integrated reader)

## Looking for more information?

Are you looking for specifications or part numbers?

Do you want to talk with a solutions specialist?

**Please contact us using the link to the right.**





## selfCIRC PRO Hardware Options

The following table outlines specifications for the PC available from Tech Logic.

<b>Data</b>	RJ-45 Ethernet
<b>Touchscreen</b>	23.81" LED touchscreen (landscape or portrait orientation) 16:9 aspect ratio Projective capacitive touchscreen
<b>PC</b>	Dell Pro AIO, i5, 16GB memory, 256GB SSD, Windows 11 Pro
<b>RFID Equipment</b>	13.56 HMz HF Reader (1.2w) ISO 15693, ISO 18000-3 Multi-item capacity
<b>Barcode Scanner</b>	2-D imager, Smartphone enabled All library barcode symbologies
<b>Receipt Printer</b>	High speed thermal printer Full/partial cut options
<b>Credit/Debit Payment</b> <i>*Optional</i>	VeriFone, Comprise
<b>Cash/Coin Payment</b> <i>*Optional</i>	Jamex Payment Unit
<b>Reporting and Mgmt</b>	Centralized administrative reporting and management included via Tech Logic's central web-based application—baseCAMP
<b>Software</b>	Powered by circIT SUITE

The following table outlines minimum specifications should the library decide to provide its own PC.

<b>CPU / Memory (RAM) / Hard Disk</b>	Dual Core / 8 GB / 100GB
<b>Operating System</b>	Windows 11 Pro 64-bit or Windows 11 Enterprise IOT LTSC
<b>Additional Software:</b>	1) .NET Framework version 4.8 or newer; 2) Microsoft Edge;
<b>Networking</b>	TCP/IP connectivity to the baseCAMP Web Application Server

# selfCIRC KIDS

PATRON SELF-SERVICE

selfCIRC KIDS is designed specifically for your younger library patrons. With a lower RFID shelf, a smaller design, and your own vinyl wrap, selfCIRC KIDS provides a great introduction to self-service for your younger patrons.

**Create your own design for your kiosk's vinyl wrap!** Make your selfCIRC KIDS unit a source of inspiration for patrons in your children's section!

Powered by our circIT SUITE software, all selfCIRC units can showcase your desired branding, workflow, URL-based signage, and URL-based apps.

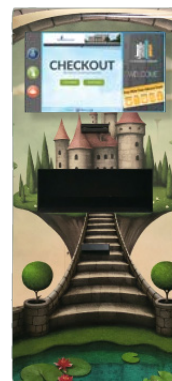

## DEVICE MANAGEMENT

Changes can be applied system-wide, branch-wide, or down to the terminal level from baseCAMP, our central web-based application.



## UNIQUELY YOURS

Every aspect—from your own artwork on the kiosk to your own checkout screen flow—can be customized to inspire your younger patrons.



## selfCIRC KIDS Kiosk

<b>Kiosk Dimensions</b>	H: 53.25"    W: 23.125"    D: 24.5"
<b>Kiosk Weight</b>	170 lbs.
<b>Power</b>	110v AC
<b>Data</b>	RJ-45 Ethernet
<b>Touchscreen</b>	22" LED touchscreen (portrait orientation) 16:9 aspect ratio Projective capacitive touchscreen
<b>PC</b>	Dell Optiplex AIO, I5, 4GB memory, 128 GB storage, Win10 Pro
<b>RFID Equipment</b>	13.56 HMz HF Reader (1w) ISO 15693, ISO 18000-3 Multi-item capacity
<b>RFID Shelf Dimensions</b>	H: 6.0"    W: 16.0"    D: 12"
<b>Barcode Scanner</b>	2-D imager, Smartphone enabled All library barcode symbologies
<b>Receipt Printer</b>	High speed, 80mm thermal printer Full/partial cut options
<b>Credit/Debit Payment</b> <i>*Optional</i>	VeriFone, Comprise
<b>Cash/Coin Payment</b> <i>*Optional</i>	Jamex Payment Unit
<b>Unit Color Options</b>	Stock and custom Pantone powder coating available Custom vinyl wrapping available
<b>Reporting and Mgmt</b>	Centralized administrative reporting and management included via Tech Logic's central web-based application—baseCAMP
<b>Software</b>	Powered by circIT SUITE

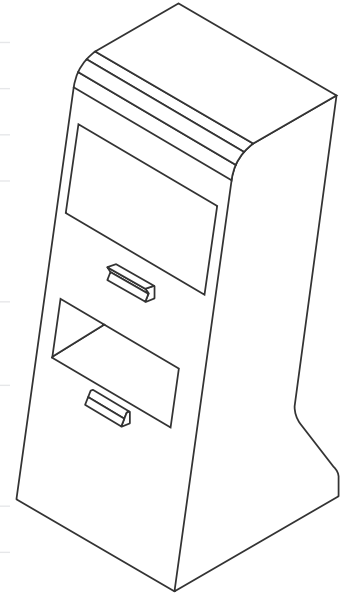

## circIT SUITE

SELF-SERVICE and  
STAFF SOFTWARE PACKAGE

Tech Logic's circIT SUITE software package is designed specifically for libraries, providing all of our self-service and staff station software for powerful circulation workflows including the following:

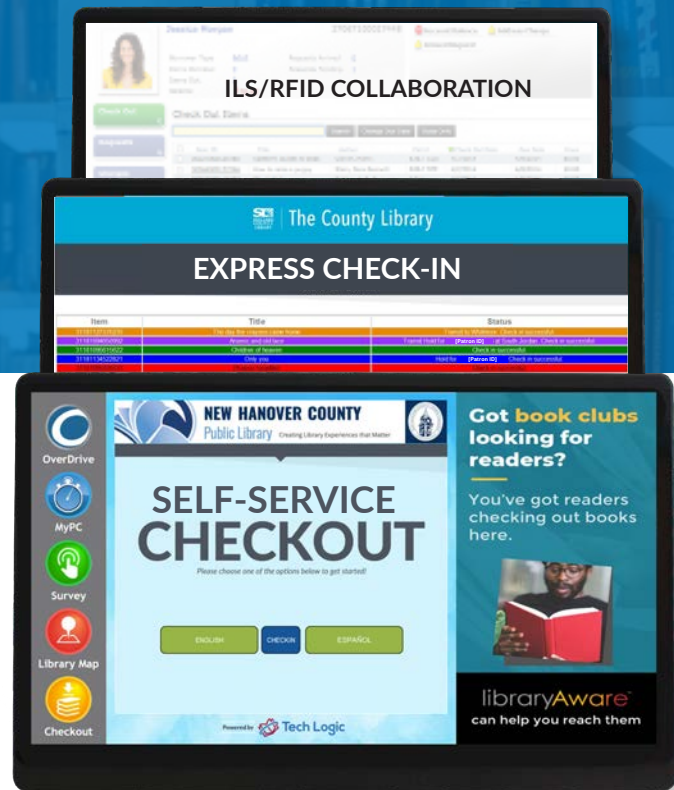

**Self-Service Checkout.** circIT's self-service interface uses SIP2 communication to conduct reliable barcode and RFID checkout while facilitating patron convenience through touch-free capability, easy renewals, URL-based signage and/or applications, and much more.



**Express Check-In.** circIT's SIP2 check-in functionality communicates with the ILS via SIP2 and, as a result, can bypass the ILS circulation interface and allow staff (or even patrons, if desired) to conduct faster, higher-volume check-in.



**Staff Station (ILS/RFID Collaboration).** circIT works with your ILS circulation interface to conduct RFID circulation. With this workflow, staff's interaction will be with the ILS interface, as it is now—the circIT software will simply add RFID functionality to the process.



**RFID Read/Write.** With circIT, if needed, staff can also read and write RFID tags without circulation and without ILS connection.



# Self-Checkout

Tech Logic’s self-checkout software, designed specifically for libraries, powers all of our self-checkout solutions. The software communicates with the ILS via SIP2 to conduct reliable and user-friendly checkout and inspire patron engagement according to library strategy.



## INSIGHTFUL REPORTING

Through baseCAMP, our central web-based application, staff can explore pre-configured or custom statistical reports for any or all selfCIRC units.



## FLEXIBLE ENGAGEMENT

selfCIRC’s interface can integrate URL-based elements like marketing signage, promotions, web pages and applications, and much more.

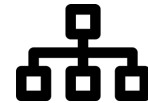

## WEB-BASED CONTROL

Configurations can be applied system-wide, branch-wide, or down to the terminal level from baseCAMP, our central web-based application.

**The workflow and screenshots shown below are examples.** The self-checkout software’s workflow, text, colors, layout, and more are customizable to fit the library’s needs. A typical workflow might include the following:

- The patron brings their items to the self-check station.
- The patron selects their language (if applicable).
- The patron presents their library card as applicable via RFID, barcode, or manual entry.

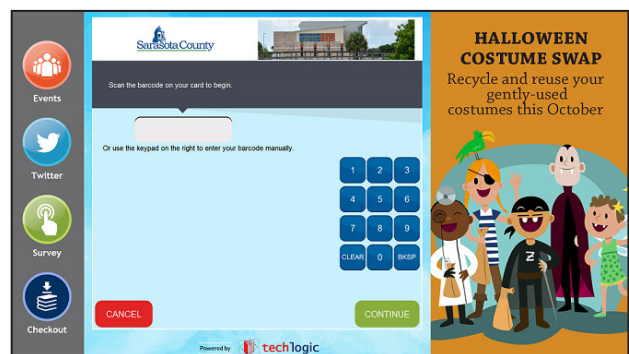
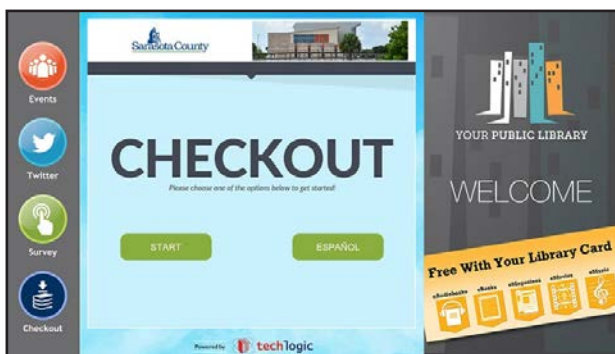

Self-Checkout continues on the following page



## Self-Checkout, continued

- The self-checkout software sends patron card information to the SIP2 server and displays any account-related messages that return from the ILS. The patron can review on-hold, checked-out, and overdue items, pay a fine (if applicable), and more.

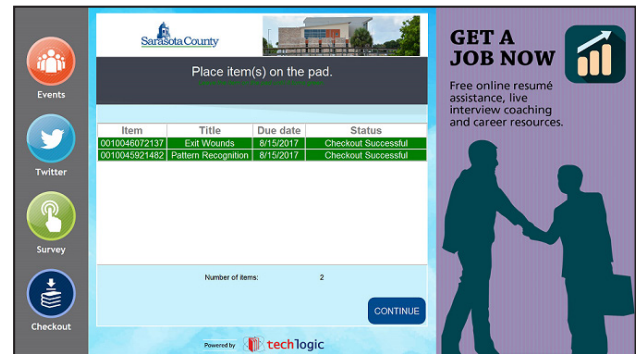
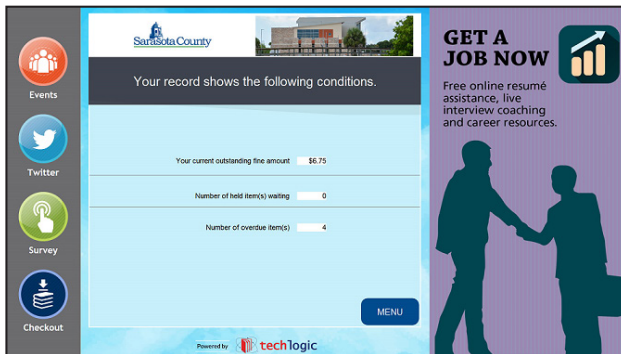

- Within the checkout screen, the patron can scan their items using the integrated barcode scanner or process multiple items in a stack via RFID. The software will process detected materials and will also display any materials that are available for renewal.
- Each item will be verified against the ILS. The item status and patron status within the ILS dictate if an item can be checked out. Once processed and cleared by the ILS, the item is successfully checked out. On the screen, the patron sees each item turn from yellow to green upon successful checkout. If an item is blocked by the ILS and cannot be checked out, that item turns from yellow to red along with any applicable instructions.
- The patron can choose whether to receive a checkout receipt via email, print, or both—or they can choose to receive no receipt. The checkout transaction is complete.



## No-Touch Self-Checkout Workflow

Because our software features a completely customizable interface and workflow, our customers can make workflow changes to create a no-touch self-checkout experience for patrons in accordance with their health and safety strategy.



## Staff Station (ILS/RFID Collaboration)

The circIT software works with the ILS circulation interface to conduct RFID circulation and item management. With this workflow, staff's interaction will be with the ILS interface, as it is now—the circIT software will simply add RFID functionality to the process.

- **To check out library items using the ILS interface**, the staff member places items containing the RFID tags on the RFID antenna when the ILS is ready for checkout. The circIT software applies the data from the RFID tags to the ILS interface for processing. The circIT STAFF software also turns security off for the applicable RFID tags.
- **To check in library items using the ILS interface**, the staff member places the items containing the RFID tags on the antenna when the ILS is ready for check-in. The circIT software applies data from the RFID tag(s) to the ILS interface for processing. The circIT software also turns security on for the applicable RFID tags.

## Staff Station (Express Check-In)

In addition to collaboration with the ILS interface (i.e. ILS/RFID Collaboration), staff can choose to bypass the ILS interface and switch to a simplified SIP2 interface if they want to conduct even faster and higher-volume RFID check-in without any popups from the ILS interface. We recommend that library staff take advantage of this workflow when they need to check in a large volume of items. Should the need arise, switching back to the ILS interface is easy.

Within this interface, the direct SIP2 interface displays pass-through ILS circulation messages that it receives via SIP2 and facilitates at-a-glance visual representation of each item's check-in results (library-customizable colors for checked in; transit; hold; transit hold; and more).

## RFID Read/Write

Whenever a staff member wants to read, write, or change an RFID tag without circulating item(s), he or she can simply access the circIT interface with a keystroke. No connection with the ILS is needed for these tag reading/writing functionalities.

- **To write data to an RFID tag (without circulating the item)**, the staff member selects read/write mode within the circIT interface, places the corresponding RFID-tagged item on the antenna, and either scans a corresponding barcode or enters the barcode manually. The circIT software will write the barcode to the RFID tag that is on the antenna.
- **To read RFID tag(s) and/or change security bit status(es) (without circulating items)**, the staff member simply places the library item(s) on the RFID antenna and, within the circIT software interface, selects security ON or security OFF.

# staffCIRC PRO

## STAFF CIRCULATION TOOLS

Tech Logic's staffCIRC PRO technology will equip library staff to conduct a variety of efficient circulation workflows using RFID technology, which is significantly faster than barcode workflows.

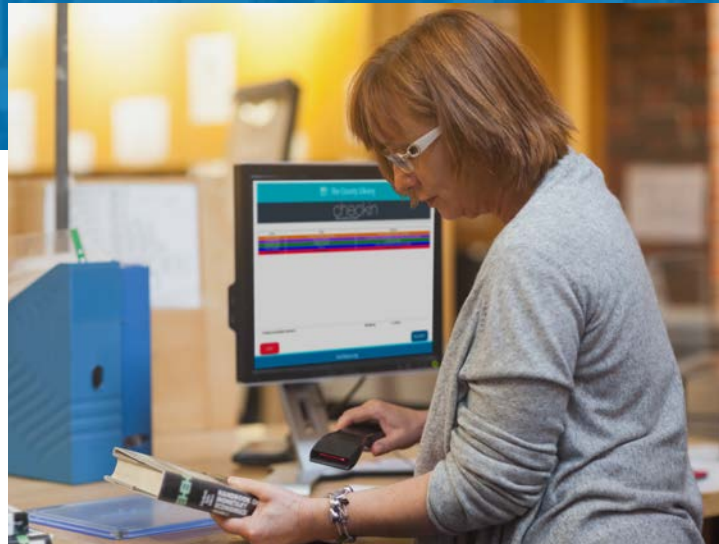

Tech Logic can provide RFID equipment and software to enhance the library's existing workstations, and (if desired) we can also furnish the library with PCs, monitors, and additional peripheral equipment.

Our staffCIRC PRO solution is powered by our circIT software, which is included with our circIT SUITE and circIT STAFF software packages.



### FIT YOUR NEEDS

You can add staffCIRC PRO technology to your existing workstations, or Tech Logic can deliver new peripheral hardware for your staff.



### FAMILIAR WORKFLOW

For circulation, staff's interaction can be with the ILS interface, as it is now—our software can simply add streamlined RFID functionality to the process.



### QUICK READ/WRITE

Also, if needed, staff can access the software apart from the ILS to read and write RFID tags without circulation and without ILS connection.



## Considerations for RFID High-Frequency Antennas

Whether you're deploying RFID for staff workstations or for a self-checkout solution, Tech Logic has the right RFID High-Frequency (HF) antenna for your scenario.

Different antennas bring different benefits. It's all about choosing the right feature combination for each use case throughout the library. You'll want to consider...



**FOOTPRINT** | Conserving desk space may be an important part of your overall decision, depending on each use case.



**SHIELDING** | A shielded antenna keeps the high-frequency field contained in a vertical range above the antenna, preventing unwanted RFID detection below and beside the antenna. It also helps prevent detuning if the antenna is stationed on a metal surface.



**READ RANGE** | How many library items can you stack on the antenna for simultaneous processing? That depends on the antenna's read range! The antenna's read range also depends on other factors like the kinds of library items in your stack.

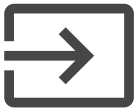

**READER INTEGRATION** | On some antenna options, the reader is built into the antenna's housing for a consolidated, one-piece deployment. On other options, the reader is a separate component.



# RFID High-Frequency Antenna Options

When it comes to an antenna’s footprint, shielding, read range, and reader integration, different feature combinations fit different scenarios throughout the library.

Tech Logic offers three antenna options. All of these antenna options work directly with Tech Logic’s software for circulation workflows across the library operation.



	SPAD102	PAD74	ANTS240/180
<b>FOOTPRINT</b>	14.8in x 10.0in x 1.1in	9.45in x 7.09in x 0.51in	9.45in x 7.09in x 0.59in
<b>SHIELDING</b>	Shielded	Unshielded	Shielded
<b>READ RANGE</b>	Up to 12 inches	Up to 7 inches	Up to 7 inches
<b>READER INTEGRATION</b>	Integrated reader	Integrated reader (Entire PAD74 unit is powered by one USB)	Non-integrated reader (Still included with purchase price)
<b>SUMMARY</b>	This option offers an integrated reader and a shielded antenna (if you don't mind a larger footprint)	This option offers a smaller footprint, one-cord USB power, and an integrated reader (if you don't mind an unshielded antenna)	This option offers a smaller footprint and a shielded antenna (if you don't mind a non-integrated reader)

## Looking for more information?

Are you looking for specifications or part numbers?

Do you want to talk with a solutions specialist?

**Please contact us using the link to the right.**





## Optional staffCIRC PRO Workstation

The following table outlines specifications for the PC available from Tech Logic.

<b>Data</b>	RJ-45 Ethernet
<b>Touchscreen</b>	23.81" LED touchscreen (landscape or portrait orientation) 16:9 aspect ratio Projective capacitive touchscreen
<b>PC</b>	Dell Pro AIO, i5, 16GB Memory, 256GB SSD, Windows 11 Pro
<b>RFID Equipment</b>	13.56 HMz HF Reader (1.2w) ISO 15693, ISO 18000-3 Multi-item capacity
<b>Barcode Scanner</b>	2-D imager, Smartphone enabled All library barcode symbologies
<b>Receipt Printer</b>	High speed thermal printer Full/partial cut options
<b>Credit/Debit Payment</b> *Optional	VeriFone, Comprise
<b>Cash/Coin Payment</b> *Optional	Jamex Payment Unit
<b>Status Monitoring</b>	Centralized terminal online status monitoring included via Tech Logic's central web-based application—baseCAMP
<b>Software</b>	circIT SUITE or circIT STAFF software package

The following table outlines minimum specifications should the library decide to provide its own PC.

<b>CPU / Memory (RAM) / Hard Disk</b>	Dual Core / 8 GB / 100GB
<b>Operating System</b>	Windows 11 Pro 64-bit, <b>or</b> Windows 11 Enterprise IOT LTSC
<b>Additional Software:</b>	1) .NET Framework version 4.8 or newer; 2) Microsoft Edge;
<b>Networking</b>	TCP/IP connectivity to the baseCAMP Web Application Server

# circIT STAFF

## STAFF SOFTWARE PACKAGE

Tech Logic's circIT STAFF software package is for terminals that only need the staff-related features of circIT SUITE. The circIT STAFF package empowers staff workstations with full RFID functionality, including the following workflows:

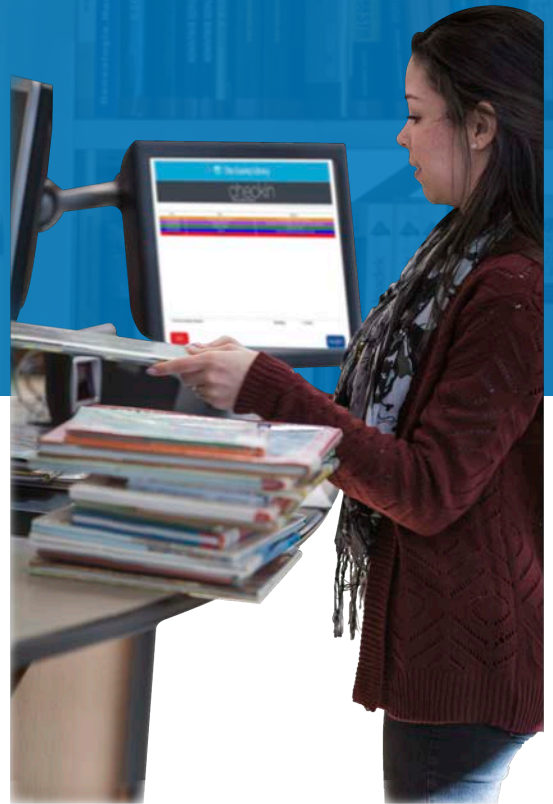

**Staff Station (ILS/RFID Collaboration).** circIT works with your ILS circulation interface to conduct RFID circulation. With this workflow, staff's interaction will be with the ILS interface, as it is now—the circIT software will simply add RFID functionality to the process.



**Staff Station (Express Check-In).** circIT's SIP2 check-in functionality communicates with the ILS via SIP2 and, as a result, can bypass the ILS circulation interface and allow staff to conduct faster, higher-volume check-in.



**RFID Read/Write.** With circIT, if needed, staff can also read and write RFID tags without circulation and without ILS connection.



## Staff Station (ILS/RFID Collaboration)

The circIT software works with the ILS circulation interface to conduct RFID circulation and item management. With this workflow, staff's interaction will be with the ILS interface, as it is now—the circIT software will simply add RFID functionality to the process.

- **To check out library items using the ILS interface**, the staff member places items containing the RFID tags on the RFID antenna when the ILS is ready for checkout. The circIT software applies the data from the RFID tags to the ILS interface for processing. The circIT STAFF software also turns security off for the applicable RFID tags.
- **To check in library items using the ILS interface**, the staff member places the items containing the RFID tags on the antenna when the ILS is ready for check-in. The circIT software applies data from the RFID tag(s) to the ILS interface for processing. The circIT software also turns security on for the applicable RFID tags.

## Staff Station (Express Check-In)

In addition to collaboration with the ILS interface (i.e. ILS/RFID Collaboration), staff can choose to bypass the ILS interface and switch to a simplified SIP2 interface if they want to conduct even faster and higher-volume RFID check-in without any popups from the ILS interface. We recommend that library staff take advantage of this workflow when they need to check in a large volume of items. Should the need arise, switching back to the ILS interface is easy.

Within this interface, the direct SIP2 interface displays pass-through ILS circulation messages that it receives via SIP2 and facilitates at-a-glance visual representation of each item's check-in results (library-customizable colors for checked in; transit; hold; transit hold; and more).

## RFID Read/Write

Whenever a staff member wants to read, write, or change an RFID tag without circulating item(s), he or she can simply access the circIT interface with a keystroke. No connection with the ILS is needed for these tag reading/writing functionalities.

- **To write data to an RFID tag (without circulating the item)**, the staff member selects read/write mode within the circIT interface, places the corresponding RFID-tagged item on the antenna, and either scans a corresponding barcode or enters the barcode manually. The circIT software will write the barcode to the RFID tag that is on the antenna.
- **To read RFID tag(s) and/or change security bit status(es) (without circulating items)**, the staff member simply places the library item(s) on the RFID antenna and, within the circIT software interface, selects security ON or security OFF.

# staffCIRC TRAK

## SHELF MANAGEMENT SYSTEM



staffCIRC TRAK brings real-time shelf management with the sweep of an RFID wand. The system communicates with the ILS in real time, notifying the user immediately when the wand detects a shelved item that has an exception status in the ILS.

Quickly find and immediately pull lost, trace, missing, claimed-returned, or any other exception-status items. No more printed reports! If desired, staffCIRC TRAK can also do traditional inventory, load and find custom item lists, check item security, and more.



### CASE AVAILABLE

Protect your staffCIRC TRAK with a form-fit, hardshell case. Each case comes with a lifetime warranty!

**"We went from thousands of missing items...to twelve missing items system wide."**

*Andrea Taylor, Technology Coordinator  
Sarasota County Libraries*



### CHECK OUT THE STORIES!

Visit [www.tech-logic.com/product-categories/shelf-management](http://www.tech-logic.com/product-categories/shelf-management) for shelf management tips and customer stories!



### HANDHELD RFID READER/ANTENNA

<b>Dimensions</b>	L: 18.1" W: 10.2" D: 1.06"
<b>Antenna Thickness</b>	0.06"
<b>Weight</b>	1.32 lbs. (with battery)
<b>Operating Frequency</b>	13.56 MHz
<b>Supported Transponders</b>	ISO 15693, ISO 18000-3m3
<b>Connectivity Options (Supports WiFi and Bluetooth)</b>	WLAN/WiFi (Security protocols WEP/WPA/WPA2) BLE v5.0
<b>Battery</b>	Li-ion; Library tested for 6 hours under normal operation (1.5W); Library tested for 4 hours with Boost Mode activated (4W) (Optional) Additional li-ion battery & charger
<b>Operating/Storage</b>	Operating: 0° F - 104° F, 5-90% relative humidity Storage: -13° F - 131° F, 5-90% relative humidity

### LAPTOP WORKSTATION

While commodity equipment may vary slightly due to market volatility, the information outlined below represents like-quality specifications for the staffCIRC TRAK workstation.

<b>Type</b>	Lenovo Thinkbook 2-in-1
<b>Dimensions</b>	W: 12.3" D: 8.8" H: 0.7
<b>Weight</b>	3.62 lbs
<b>Screen</b>	14" diagonal touchscreen   300 nits   Anti-glare   Anti-fingerprint
<b>Operating System</b>	Windows 11 Pro 64-bit
<b>Processor</b>	Intel Core Ultra 5
<b>Memory</b>	2x 8GB SODIMM DDR5-5600
<b>Storage</b>	256 GB SSD
<b>Connectivity Options (Supports WiFi and Bluetooth)</b>	WiFi 6E, 802.11ax 2x2 + BT5.3
<b>Battery</b>	Integrated 60 Wh

### PROTECTIVE CASE (AVAILABLE FOR PURCHASE)

<b>Dimensions</b>	L: 22.3" W: 18" D: 8.3"
<b>Weight (Empty)</b>	10.83 lbs
<b>Construction</b>	Multi-Layer, Form Fit, Hard Shell
<b>Storage</b>	Max: 180.0° F Min: -69.0° F

# rfidGATE WAVE

## SECURITY GATES

Designed to seamlessly integrate with any library environment, rfidGATE WAVE delivers powerful item detection and people counting.

With various installation options and multiple-aisle configurations available, rfidGATE WAVE is capable of covering over 30 feet of entryway.

These security gates interface with our web-based management application, baseCAMP, to empower your staff with people counts, alarm monitoring, and item alarm reports (including ILS data).



### FLEXIBLE WIDTH

Ranging from 43" to 51" from base to base, rfidGATE WAVE delivers additional coverage area for better protection of your library materials.



### ENERGY EFFICIENT

Detection when you need it. rfidGATE WAVE automatically activates when patrons are approaching, cutting down on your monthly energy costs.



### REMOTE MANAGING

Peace of mind from any staff terminal. Remotely monitor, configure, and manage all security gates from a central web-based interface.



## rfidGATE WAVE Specifications

<b>Dimensions</b>	W: 27.5"      H: 67.3"      D: 2.8"
<b>Weight</b>	55 lbs. (per pedestal)
<b>Supply Voltage</b>	24V DC (+/- 15%)
<b>Power Consumption</b>	Max 32 VA
<b>Operating Frequency</b>	13.56 MHz
<b>Transponders</b>	ISO 15693, ISO 18000-3 Mode 1, NXP I-Code 1
<b>Interface</b>	USB Ethernet
<b>Aisle Width</b>	Up to 51" 43" recommended
<b>Operating Temperature</b>	-13° F to 122° F -25° C to 50° C
<b>Storage Temperature</b>	-13° F to 158° F -25° C to 70° C
<b>Features</b>	Configurable up to 6 aisles (7 panels) Convenient aisle widths of 43" (recommended) or wider Directional alarming Bi-directional, radar-based people counting Dynamic tuning antenna Remote diagnostics and configuration Power-save mode
<b>Reporting and Mgmt</b>	Centralized administrative reporting and management included via Tech Logic's central web-based application—baseCAMP

# rfidGATE EXCELLENCE

## SECURITY GATES

Specially designed for high traffic areas, rfidGATE EXCELLENCE sets a new standard for the protection of your library items.

rfidGATE EXCELLENCE pedestals can be positioned 59" apart, providing easy access for large groups, strollers, wheel-chairs, and deliveries. These gates detect multiple tags in any orientation—even at a wider distance.

rfidGATE EXCELLENCE interfaces with our web-based management application, baseCAMP, to empower your staff with people counts, alarm monitoring, and item alarm reports (including ILS data).



### COUNTING IN & OUT

Never miss a patron count. Get greater insight into the flow of your patrons with bi-directional, radar-based people counting and reporting.



### ENERGY EFFICIENT

Detection when you need it. rfidGATE EXCELLENCE automatically activates when patrons are approaching, cutting down on your monthly energy costs.



### REMOTE MANAGING

Peace of mind from any staff terminal. Remotely monitor, configure, and manage all security gates from a central web-based interface.



## rfidGATE EXCELLENCE Specifications

<b>Dimensions</b>	W: 27.5"      H: 67.3"      D: 2.8"
<b>Weight</b>	65 lbs. (per pedestal)
<b>Supply Voltage</b>	24V DC (+/- 15%)
<b>Power Consumption</b>	Max 32 VA
<b>Operating Frequency</b>	13.56 MHz
<b>Transponders</b>	ISO 15693, ISO 100-3 Mode 1, NXP I-Code 1
<b>Interface</b>	USB Ethernet
<b>Aisle Width</b>	Up to 63" 59" recommended
<b>Operating Temperature</b>	-13° F to 122° F -25° C to 50° C
<b>Storage Temperature</b>	-13° F to 158° F -25° C to 70° C
<b>Features</b>	Configurable up to 3 aisles (4 panels) Large aisle widths of 59" (recommended) or wider Directional alarming Bi-directional, radar-based people counting Dynamic tuning antenna Remote diagnostics and configuration Power-save mode
<b>Reporting and Mgmt</b>	Centralized administrative reporting and management included via Tech Logic's central web-based application—baseCAMP

# rfidTAG CASE

RFID CONVERSION TOOL

For more than two decades, Tech Logic has worked exclusively with libraries on RFID technologies and conversions. We are happy to consult with your library as you undertake your RFID conversion project.



Using the same RFID read/write software found in our staffCIRC PRO workstation, the rfidTAG CASE empowers staff and community volunteers with an exceptionally simple workflow that requires no ILS connection. Simply place the RFID tag onto the antenna, scan the item's barcode, and apply the tag to the item.



## SECURE CASE

The RFID Tagging equipment is secured and stored in a hard-sided case with handles for security and convenience for your staff.



## LOCATE WEEDS

By uploading a text file at the beginning of your conversion, rfidTAG CASE can identify and isolate weed candidates during the tagging process.



## RENT FOR CONVERSION

Most libraries decide to rent the rfidTAG CASE to streamline their initial RFID conversion. Then, they use their other RFID equipment for new items.



## rfidTAG CASE

<b>Tags</b>	ISO 15693, ISO 18000-3
<b>Barcode Scanner</b>	Linear imager All library barcode symbologies
<b>Computer</b>	Dell Latitude (or similar) Windows 10 Battery powered for optimal mobility. Power supply included.
<b>RFID Equipment</b>	13.56 MHz HF Reader (0.5W) ISO 15693, ISO 18000-3 Multi-Item capacity
<b>Reporting</b>	Centralized administrative reporting via Tech Logic baseCAMP* <b>*Feature Coming Soon</b>
<b>Software</b>	Powered by circIT SUITE

# rfidTAG TEAM

## RFID CONVERSION SERVICE

The most time consuming and costly aspect of an RFID conversion is not the RFID tags—it's the actual conversion process. If tasked to staff members, the conversion would remove the assigned staff from their patron-facing activities. The challenges can be even greater for larger library systems converting multiple branches simultaneously.

For more than two decades, Tech Logic has been working exclusively with libraries to implement RFID technologies. Our rfidTAG TEAM can implement your RFID conversion from start to finish. We'll make sure conversion is completed on-time, on-budget, and in-sync with other project elements.



### PROJECT PLANNING

Tech Logic will provide a project manager who works with you to establish and maintain a thorough project plan for the entire conversion.



### LOCALIZED STAFFING

Tech Logic works with a number of organizations across the country to source, train, and manage a conversion staff that is local to your library.



### GUARANTEED RESULT

With quality control checks during the entire conversion, Tech Logic ensures that items are tagged correctly before the job is complete.



# rfidTAG TEAM Tagging Services

## What's included?

Tech Logic will make sure your library's RFID conversion is completed on-time, on-budget, and in-sync with other project elements. We will provide technicians and a project manager on-site for a completion timeline that corresponds with project scope. All conversion equipment (except the tags themselves), project management, personnel costs, quality control, and shipping are covered in the quoted price.

## Will it impact library operations?

Tagging the shelved collection should not impact patrons' use of the library. The mobile conversion stations are no more intrusive than a staff member pushing a book truck around the stacks to re-shelve items.

Tech Logic can coordinate tagging after hours or during library open hours. Most customers choose to have us complete tagging during open library hours, for cost effectiveness. If completed after hours, the library will only need to provide any desired library security or oversight for our staff working in closed buildings.

Behind the scenes, the library should anticipate having a staff member to coordinate with the tagging team about processes and handle any questions that may arise. The library will also need to coordinate with the tagging team to handle returned materials before they are re-shelved.

## What's the process?

Technicians simply place the RFID tag onto the antenna, scan the item's barcode, and apply the tag to the item. If the library desires, we can use a library-supplied weed list to identify and isolate candidates for weeding while we tag. To calculate an estimated length of time to tag a location, we plan for each person (or pair) to tag 300-400 items per hour for books and 100 items per hour for CDs and DVDs using full-overlay AV tags. These figures, as well as library goals and timeline parameters, determine the size of the tagging team. In addition, 80% of a library collection is typically on the shelves at any given time; 20% is in circulation to be tagged on return. All new materials should be tagged during processing.

## What about our other RFID equipment?

Until the tagging process is completed at a given location, that library should continue to operate as it currently does—using barcode technology to check out items. Once the tagging conversion is complete, the RFID system (self-checkout, gates, staff stations, shelf management scanning) at that location can go live.

Description	Price	Total Cost
Items for Tagging: to be determined	to be determined per item *	to be determined**
Tech Logic will provide technicians and project manager onsite. Price will include all labor, management, travel, tagging equipment (except tags), and on-site expenses.		

\* Re-barcoding of any items without readable barcodes (optional service if desired by the library): \$1.00 per item.

\*\* Minimum total project cost will correlate with at least 90% of item count.

# rfidTAG

RADIO FREQUENCY IDENTIFICATION



The first step to successful RFID conversion is choosing tags that deliver fast, reliable performance.

Your tags are the key to faster transactions, better shelf management, and improved item security using RFID capabilities.

Tech Logic has worked with hundreds of libraries to complete RFID conversions. Our rfidTAG designs exceed industry standards with high-quality materials available in formats for all types of library items. Guaranteed for the entire lifecycle of the item to which each tag is affixed, rfidTAG sets the standard for RFID tag quality and performance.



## LIBRARY STANDARD

13.56 MHz frequency labels are fully aligned with ISO/IEC 15693, 18000-3, and 28560 – the standard for RIFD tags used by all types of libraries.



## MULTIPLE FORMATS

rfidTAGs are available for printed materials, AV cases, and individual discs. Tags are guaranteed for the life of the item to which they are affixed.



## CUSTOMIZED TAGS

rfidTAGs can be customized with library logos for ownership marking, barcode “buddy labels,” pre-encoding of tag data, and more.



## rfidTAG Product Features

<b>Base Material</b>	White semi-gloss paper (thermal transfer printable) or clear PET Aluminum-etched antenna Specialized substrate for various applications Optional ISO 9706 paper, high gloss paper, clear PET, PP, or specialized label materials for specific applications
<b>Adhesive and Liner</b>	Acrylic adhesive on release paper liner
<b>Chip Memory</b>	NXP ICODE SLIX2 SLS2602 w/ 2560 bits memory/2528 bits user memory NXP ICODE SLIX SL2S2002 w/ 1024 bits memory/896 bits user memory
<b>Delivery Form</b>	Book Tags (Booklite and Racetrack): Label face-out on unwinding direction CD/DVD Overlay Tag (X-Range): Label face-in unwinding direction
<b>AFI (Application Family Identifier)</b>	For multi-application support and/or check-in/checkout library item control Usable in plain mode or 32-bit password protected
<b>EAS (Electronic Article Surveillance)</b>	On-board feature to prevent shoplifting or pilferage of books, CD's or DVD's Usable in plain mode or 32-bit password protected
<b>Product Thickness</b>	Book Tags (Booklite and Racetrack): 0.32mm CD/DVD Overlay Tag (X-Range): 0.38mm
<b>ESD</b>	+2KV maximum peak, human body model (HBM) accordingly to chip specification
<b>Product Quality</b>	Electrical inspection on 100% of units
<b>Product Options</b>	Clear PET Printed artwork (library logos for ownership marking) Barcode (single or dual, for "buddy labels") Chip encoding with static or dynamic information
<b>Operation Temperatures</b>	-20° ~ 70°C (-4° ~ 158°F), at <60% RH (according to and limited by chip specifications)
<b>Reliability</b>	Thermal Cycle Test: 100 cycles under -55° to 85°C (-67° to 185°F) 15 mins dwell Thermal Humidity Test: 168 hours under 85°C (185°F), 85% RH



# rfidTAG Racetrack (Book Tag)

## RFID Inlay

Size (final cut-out)	80 x 50 mm
Thickness (over IC)	~ 280 µm
Thickness (over antenna)	~ 160 µm

## RFID Chip

IC Code	NXP ICODE SLIX2 SL2S2602
RF Protocol	ISO/IEC 15693
Thickness	~ 120 µm
EEPROM Memory Size	2560 bits
User Memory Size	2528 bits

## Antenna Substrate (HF 13.56 MHz Identiv Smart Inlays)

Antenna Size	76x45 mm
Material	Aluminum etched on PET substrate **Optional Clear PET substrate
Cross-over Connection	Crimping process



Tag shown at actual size

## Reliability

Operating Temperatures	-20° ~ 70°C (-4° ~ 158°F), at <60%RH (according to and limited by chip specification)
Thermal Cycle Test	100 cycles under -55°/85°C (-67°/185°F) 15min dwell
Thermal Humidity Test	168 hours under 85°C (185°F)/85% RH

## Product Options

Clear PET
Printed Artwork (library logos for ownership marking)
Barcode (single or dual, for "buddy labels")
Chip encoding with static or dynamic information

## Reel Delivery Format

Flange Size	OD 230mm: ID 76mm
Unwinding Orientation:	Chip trailing
Quantity/Reel (functional units)	1,500 Units

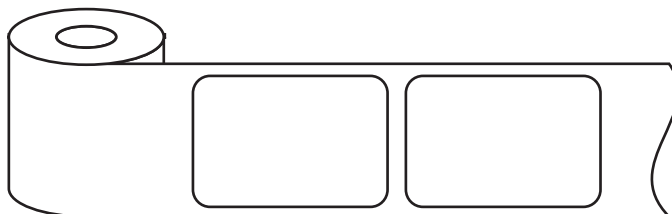



# rfidTAG Booklite (Book Tag)

## RFID Inlay

Size (final cut-out)	50 x 50 mm
Thickness (over IC)	~ 280 µm
Thickness (over antenna)	~ 160 µm

## RFID Chip

IC Code	NXP ICODE SLIX2 SL2S2602
RF Protocol	ISO/IEC 15693
Thickness	~ 120 µm
EEPROM Memory Size	2560 bits
User Memory Size	2528 bits

## Antenna Substrate (HF 13.56 MHz Identiv Smart Inlays)

Antenna Size	47x47 mm
Material	Aluminum etched on PET Substrate **optional clear PET substrate
Cross-over Connection	Crimping process

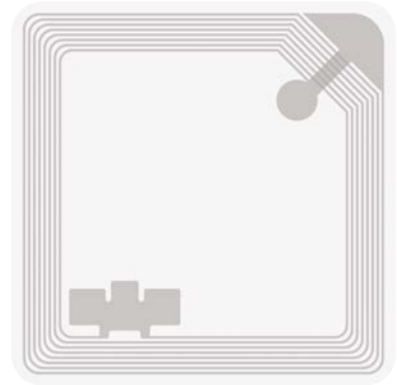

Tag shown at actual size

## Reliability

Operating Temperatures	-20° ~ 70°C (-4° ~ 158°F), at <60%RH (according to and limited by chip specification)
Thermal Cycle Test	100 cycles under -55°/85°C (-67°/185°F) 15min dwell
Thermal Humidity Test	168 hours under 85°C (185°F)/85% RH

## Product Options

Clear PET
Printed Artwork (library logos for ownership marking)
Barcode (single or dual, for "buddy labels")
Chip encoding with static or dynamic information

## Reel Delivery Format

Flange Size	OD 230mm: ID 76mm
Unwinding Orientation:	Chip trailing
Quantity/Reel (functional units)	2,000 Units

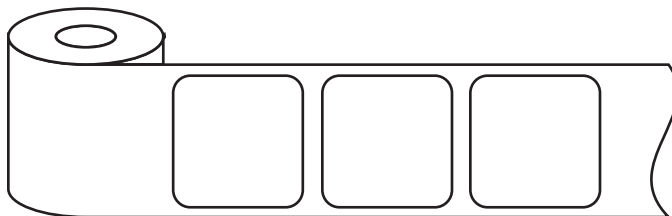



## rfidTAG X-Range (CD/DVD Tag)

### RFID Inlay

Size (final cut-out)	OD $\varnothing$ 116 mm, ID $\varnothing$ 41 mm
Thickness (over IC)	~ 400 $\mu$ m
Thickness (over antenna)	~ 280 $\mu$ m

### RFID Chip

IC Code	NXP ICODE SLIX2 SL2S2602
RF Protocol	ISO/IEC 15693
Thickness	~ 120 $\mu$ m
EEPROM Memory Size	2560 bits
User Memory Size	2528 bits

### Antenna Substrate (HF 13.56 MHz Identiv Smart Inlays)

Antenna Size	$\varnothing$ 110 mm
Material	Aluminum etched on clear, PET Substrate
Cross-over Connection	Crimping process

### Reliability

Operating Temperatures	-20° ~ 70°C (-4° ~ 158°F), at <60%RH (according to and limited by chip specification)
Thermal Cycle Test	100 cycles under -55°/85°C (-67°/185°F) 15min dwell
Thermal Humidity Test	168 hours under 85°C (185°F)/85% RH

Tag shown at actual size

### Product Options

Printed Artwork (library logos for ownership marking)

Barcode (single or dual, for "buddy labels")

Chip encoding with static or dynamic information

### Reel Delivery Format

Flange Size	OD 300mm: ID 76mm
Quantity/Reel (functional units)	1,000 Units

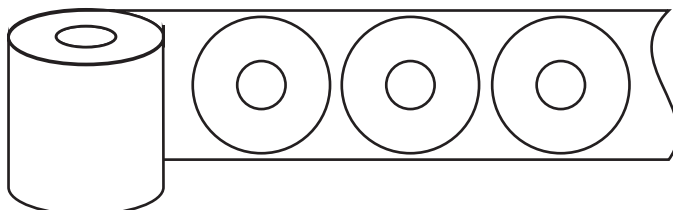
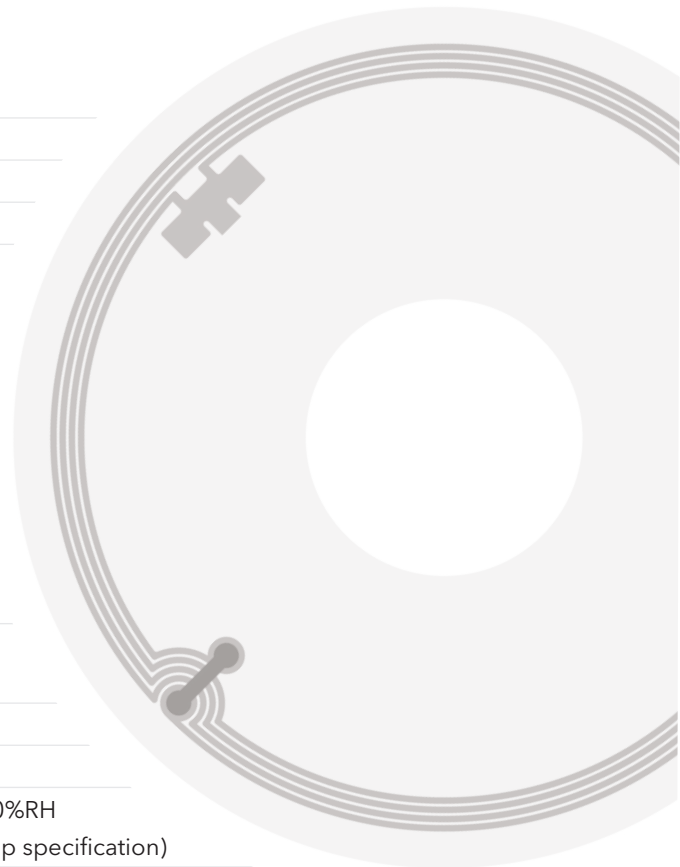



# Looking for more insights into library technology?

We'd love to talk with you. Also, check out the [News and Insights](https://www.tech-logic.com/news-insights) section of our website (<https://www.tech-logic.com/news-insights>) for resources like the following:



## RFID Tag Types, Programming, and Placement

<https://www.tech-logic.com/blogposts/rfid-tag-types-programming-and-placement>

Exploring the basics of tag types, programming processes, and placement within items.



## Five ways that RFID works for libraries

<https://www.tech-logic.com/blogposts/five-ways-that-rfid-works-for-libraries>

How can RFID technologies benefit libraries? Here are some examples.



## Library Architects and Planners—Let's Talk!

<https://www.tech-logic.com/blogposts/library-architects-designers-and-planners-lets-talk>

Pre-design is the perfect time to talk about library technology. Please reach out to us—we'd love to connect with you—and feel free to download our Architect's Kit.