

Tafrant wall light

MOROCCO
HOUDA X MEMÒRI

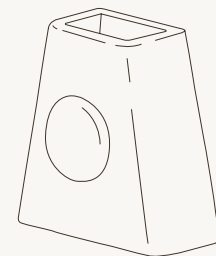
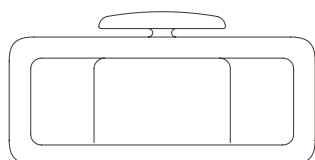
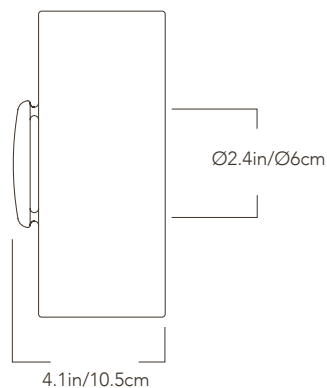
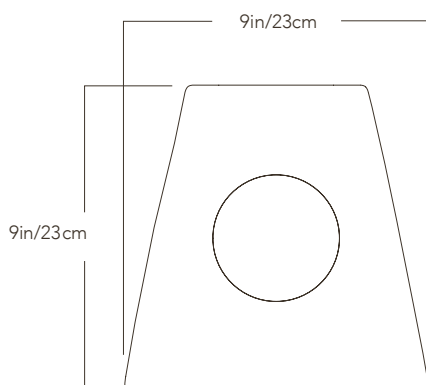

SPECIFICATIONS

Product name

Tafrant

Dimensions

9H x 9W x 4.1D in
23H x 23W x 10.5D cm

Weight

7lb/3.2kg est.

Material

Earthenware

Finishes / Colors

Terracotta, off white, brown

Fixture mounting

Designed to be mounted on a standard nail/hook (not provided) fixed on the wall above an electrical source (not provided)

Light bulb

Compatible with a E14 or equivalent (standard, not provided)

This piece is a **handbuilt ceramic co-created with the potter** Houda. It is made of **earthenware** collected from the **potter's surroundings**, slip is applied with **natural pigments** as whitewash, white clay *biyada* or manganese oxide *mogra* and it is **fired in a pit oven**. Imperfections are **part of the artisanal process** and are what make **each piece unique**.

Tafrant small wall light

MOROCCO
HOUDA X MEMÒRI

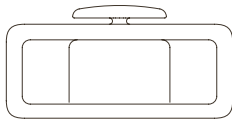
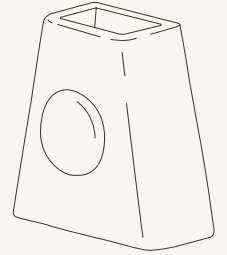
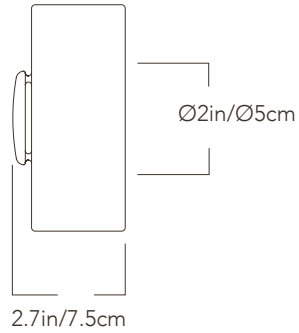
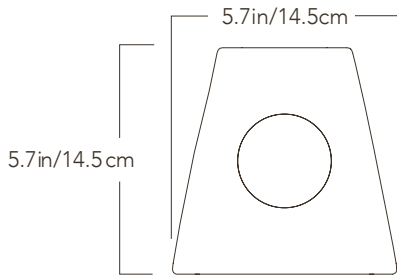

SPECIFICATIONS

Product name

Tafrant small

Dimensions

5.7H x 5.7W x 2.7 D in
14.5H x 14.5W x 7.5D cm

Weight

2.2lb/1kg est.

Material

Earthenware

Finishes / Colors

Terracotta, off white, brown

Fixture mounting

Designed to be mounted on a standard nail/hook (not provided) fixed on the wall above an electrical source (not provided)

Light bulb

Compatible with a E14 or equivalent (standard, not provided)

This piece is a **handbuilt ceramic co-created with the potter Houda**. It is made of **earthenware** collected from the **potter's surroundings**, slip is applied with **natural pigments** as whitewash, white clay *biyada* or manganese oxide *mogra* and it is **fired in a pit oven**. Imperfections are **part of the artisanal process** and are what make **each piece unique**.