

# nienkämper

## **GATEWAY™**

MEDIA LIFT TABLES & STORAGE ELEMENTS



**2026**

Prices shown are List Prices, FOB our Toronto  
Factory- freight charges are extra. Packing and/  
or crating is available, if required, upcharges apply.

# GATEWAY™ COLLECTION FINISHES — VENEER

All wood surfaces are protected with a durable polyurethane clear lacquer with UV inhibitor. This finish is known for its exceptional durability, as well as abrasion, chemical, impact and scratch resistance. Standard sheen level is 45 degrees. Optional matte, 5, 10 and 35 degree sheen levels are available on request at no additional cost.

Wood Species	Order Code	Veneer/Stain	Upcharge
Maple	F-01	Natural Maple	No upcharge applies.
	F-02	Natural Curly Maple - Rotary Cut	Add 15%.
	F-03	Natural Bird's Eye Maple - Rotary Cut	Call Customer Service for pricing.
	F-04	Maple Stained Pear	No upcharge applies.
Cherry	F-05	Natural Cherry	No upcharge applies.
	F-06	Standard Cherry	No upcharge applies.
	F-07	Cherry Stained Amber	No upcharge applies.
	F-08	Cherry Stained Auburn	No upcharge applies.
	F-09	Cherry Stained Burgundy	No upcharge applies.
Mahogany	F-10	Light Mahogany	No upcharge applies.
	F-11	Medium Mahogany	No upcharge applies.
	F-12	Dark Mahogany	No upcharge applies.
	F-13	Red Mahogany	No upcharge applies.
Anagre	F-14	Natural Figured Anagre - Qtr. Cut Book-Match	Add 15%.
	F-15	Figured Anagre Stained Amber - Qtr. Cut Book-Match	Add 15%.
Sycamore	F-16	Natural Figured Sycamore - Qtr. Cut Book-Match	Add 15%.
Walnut	F-17	Burnt Walnut	No upcharge applies.
	F-19	Natural Walnut- Flat Cut Book-Match	No upcharge applies.
	F-19FM	Natural Walnut- Flat Cut Book-Match (matte sheen)	No upcharge applies.
	F-27F	Creamy Walnut- Flat Cut Book-Match (10° sheen)	No upcharge applies.
	F-27R	Creamy Walnut - Rift Cut Slip-Match (10° sheen)	Add 5%
	F-28	Tawny Walnut	No upcharge applies.
	F-31FM	Autumn Walnut- Flat Cut Book-Match (matte sheen)	No upcharge applies.
	F-31RM	Autumn Walnut - Rift Cut Slip-Match (matte sheen)	Add 5%
Oak	F-18F	Natural White Oak - Flat Cut Book-Match (10° sheen)	No upcharge applies.
	F-18R	Natural White Oak - Rift Cut Slip-Match (10° sheen)	Add 5%
	F-26	Charcoal Ash On Oak- Flat Cut Book- Match (10° sheen)	No upcharge applies.
	F-29F	Smoky Oak - Flat Cut Book-Match	No upcharge applies.
	F-29R	Smoky Oak - Rift Cut Slip-Match	Add 5%
	F-29FM	Smoky Oak - Flat Cut Book-Match (matte sheen)	No upcharge applies.
	F-29RM	Smoky Oak - Rift Cut Slip-Match (matte sheen)	Add 5%
	F-30FM	Whisper White Oak - Flat Cut Book-Match (matte sheen)	No upcharge applies.
	F-30RM	Whisper White Oak - Rift Cut Slip-Match (matte sheen)	Add 5%
	F-32FM	Cotton White Oak - Flat Cut Book-Match (matte sheen)	No upcharge applies.
F-32RM	Cotton White Oak - Rift Cut Slip-Match (matte sheen)	Add 5%	
Sapele – Ribbon Stripe	F-20	Natural Ribbon Strip Sapele - Qtr. Cut Slip-Match	No upcharge applies.
Moabi (Cherry substitute)	F-21	Natural Moabi - Quarter - Qtr. Cut Book-Match	No upcharge applies.
Cape Coast Walnut	F-22	Dark Cape Coast Walnut - Qtr. Cut Slip-Match	No upcharge applies.
	F-23	Natural Cape Coast Walnut - Qtr. Cut Slip-Match	No upcharge applies.
	F-23	Natural Cape Coast Walnut - Qtr. Cut Slip-Match	No upcharge applies.
Ash	F-25	Slate Gray Ash - Qtr. Cut Slip-Match	No upcharge applies.

## VENEER GRAIN OPTIONS

Nienkämper products utilize the best quality veneers available, and, combined with Nienkämper's patented veneering systems, create work environments of incredible quality and beauty.

All veneer furniture comes standard with flat cut book-match veneer; flat cut slip-match veneer can also be specified. Quarter cut slip-match and quarter cut book-match veneers are available at a 5% upcharge. Figured Anagre and Figured Sycamore veneers are Quarter cut book-matched. Bird's Eye Maple and Curly Maple are rotary cut. Facet Edge, Taper edge, Flowform, Camber and Self edge tops with veneer are manufactured with a solid wood edge. All edges are then veneer wrapped to create a seamless profile top.

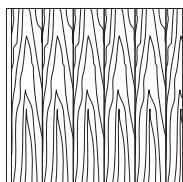

Standard V1  
Flat Cut Book-Match

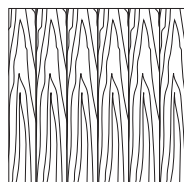

Flat Cut Slip-Match V2

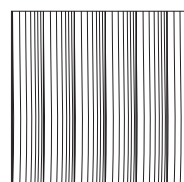

Quarter Cut Slip-Match V3  
Add 5%

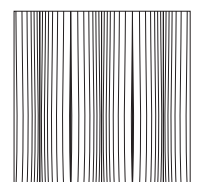

Quarter Cut Book-Match V4  
Add 5%

## GATEWAY™ COLLECTION FINISHES — PLASTIC LAMINATES

Wood grain plastic laminate surfaces are available on table tops with Facet, Taper and Self edges.

These tops are manufactured with a solid wood edge that is applied prior to the laminate top surface. This method conceals the thickness of the wood edge, while providing the durability required. Wood edges are selected that most closely resemble both the species and the color of the laminate chosen

Nienkämper has pre-selected a number of standard wood grain plastic laminates that represent a cross section of both color and species. Simply include the order code with the model number to make these selections. Alternatively wood grain plastic laminates selected outside of Nienkämper’s standard selection can be made by specifying the manufacturer as well as the description and model number of the laminate at the time of order.

Wood Grain Plastic Laminate Surfaces	Order Code	Manufacturer #	Finish
Hardrock Maple	WL2	Pionite WM791-SD	Textured/Suede
Monticello Maple	WL5	Wilsonart 7925-38	Fine Velvet Texture
Fusion Maple	WL13	Wilsonart 7909-60	Matte
New Age Oak	WL14	Wilsonart 7938-38	Fine Velvet Texture
Wild Cherry	WL18	Wilsonart 7054-60	Matte
River Cherry	WL19	Wilsonart 7937-38	Fine Velvet Texture
Montana Walnut	WL20	Wilsonart 7110T-78	Fine Grain
Skyline Walnut	WL26	Wilsonart 7964K-12	Soft Grain
Continental Walnut	WL-29	Wilsonart 8232K-05	Timbergrain
Neo Walnut	WL-30	Wilsonart 7991-38	Fine Velvet Texture
Walnut Heights	WL-31	Wilsonart 7965K-12	Soft Grain
Grayed Oak	WL-32	Formica 5791-PG	Pure Grain Texture
Millennium Oak	WL-33	Formica 5887-58	Matte
Aged Ash	WL-34	Formica 8844-WR	Woodbrush
Lowell Ash	WL-35	Wilsonart 7994-38	Fine Velvet Texture
Natural Ash	WL-36	Formica 8843-WR	Woodbrush
Norwegian Ash	WL-37	Wilsonart 8241-38	Fine Velvet Texture
Weathered Ash	WL-38	Formica 8842-WR	Woodbrush
Smoky Brown Pear	WL-39	Formica 5488-26	Oiled Wood
Studio Teak	WL-40	Wilsonart 7960K-18	Linearity
Fawn Cypress	WL-41	Wilsonart 8208K-16	Casual Rustic
Landmark Wood	WL-42	Wilsonart 7981K-12	Soft Grain
Natural Cerise	WL-43	Formica 8863-58	Matte
Natural Recon	WL-44	Wilsonart 7996-38	Fine Velvet Texture
Pecan Woodline	WL-45	Formica 5883-58	Matte

To specify the wood grain laminate required simply add the Order Code WL\_ to the model number of the product.

Samples and specific technical data is available from your local sales representative or by contacting Nienkämper’s Customer Service department at **800.668.9318**.

## GATEWAY™ COLLECTION FINISHES — PLASTIC LAMINATES

### COLORED P-LAM

Nienkämper has a number of solid color laminates to choose from, simply include the order code with the model number to make these selections. Alternatively plastic laminates selected outside of Nienkämper's standard selection can be made by specifying the manufacturer as well as the description and model number of the laminate at the time of order. Contact customer service for pricing.

Colored Plastic Laminates Surface	Order Code	Manufacturer #	Finish
Gray (Nienkämper - Light Gray/Putty)	CL-01	Wilsonart 1500-60	Matte
Plantinum Gray (Nienkämper - Medium Grey/Clay)	CL-02	Nevamar S6023T	Textured
Slate Grey (Nienkämper - Dark Grey)	CL-03	Wilsonart D91-60	Matte
Black	CL-04	Wilsonart 1595-60	Matte
Angel White	CL-05	Pionite SW-826SD	Textured/Suede
Frosty White	CL-06	Wilsonart 1573-60	Matte
White (for writable surface)	CL-07	Formica 949-90	Gloss

The unique composition offers extraordinary features coupled with a unique user experience. These include an ultra matte surface (eliminating glare), an ultra sofa feel, an anti-fingerprint surface, thermal healing of micro-scratches, increased durability as well as anti-bacterial and mold-resistant properties.

**Edgeband** matching all Fingerprint Resistant Plastic Laminate colors is only available when specifying a Taper edge. For Self edge tops 1" and 1 1/4" thick, matching edgeband are only available in Black (RL-01) and White (RL-03). When a matching edgeband is not available, the specified surface laminate is used on the edge. **Contact Customer Service for more details 800.668-9318.**

There is a 20% upcharge on our standard plastic laminate table pricing for Fingerprint Resistant Plastic Laminate.

Colored "Fingerprint Resistant" Plastic Laminate Surface	Order Code	Finish
Black	RL-01	Matte
Gray	RL-02	Matte
White	RL-03	Matte
Sand	RL-04	Matte
Brown	RL-05	Matte
Clay	RL-06	Matte
Beige	RL-07	Matte
Ash	RL-08	Matte
Smoke	RL-09	Matte

Edgeband to Match with Colored "Fingerprint Resistant" Plastic Laminate	Thickness	Order Code
Black	3/4", 1", 1-1/4"	RE-01
Gray	3/4"	RE-02
White	3/4", 1", 1-1/4"	RE-03
Sand	3/4"	RE-04
Brown	3/4"	RE-05
Clay	3/4"	RE-06
Beige	3/4"	RE-07
Ash	3/4"	RE-08
Smoke	3/4"	RE-09

# GATEWAY™ COLLECTION FINISHES — PLASTIC LAMINATES

---

## COLORED P-LAM

Both Taper and Self edge profiles are available with a colored laminate top.

**Laminate edging on Taper tops.** Edging will match the top surface and is applied before the surface laminate. By applying the laminate in this way, the seam is positioned horizontally, which makes it much less conspicuous and more durable.

**Wood edging** on Self and Taper Edge tops are applied before the laminate. By applying the wood edge in this way, the wood edge thickness is concealed, while providing the durability required. Wood species and finishes for edging can be selected from page 8.

For laminates specified outside of Nienkämper's standard selection, specify the manufacturer as well as the description and model number of the laminate selected at the time of order. For Facet edge tops, the laminate must be a post-forming grade.

**Translucent edging** on Self and Taper edge tops is applied after the surface laminate. The translucent edge is very durable. Clear translucent edge provides a good match with most white-colored laminates, while a silver translucent edge provides a metallic look and contrast to colored plastic laminates.

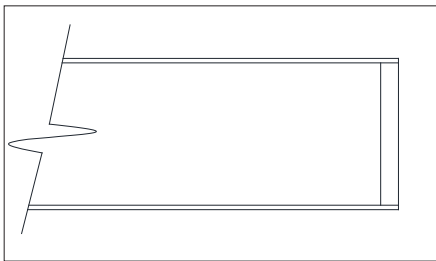

Wood Edge Detail



Laminate Edge Detail

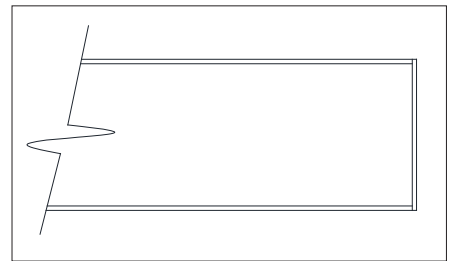

Edge Band Detail



Translucent Edge Detail

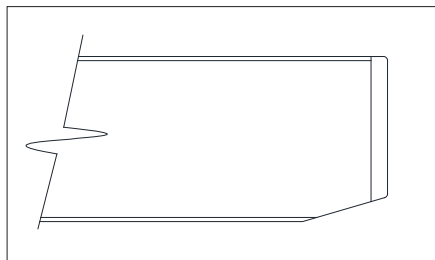

1 1/4" Thick Self Edge with Translucent Edge Detail

## Powder Coat Paint Finish

Powder coat paint is a premium finish used for its exceptional durability and refined appearance. Applied as a dry powder and cured under heat, it forms a tough, uniform surface that resists chipping, scratching, and fading—ideal for commercial environments. Nienkämper offers a curated palette of 18 color variations to suit any project.



PC-01 Nienkämper Silver



PC-02 Champagne



PC-03 Light Bronze



PC-04 Standard (Dark) Bronze



PC-05 Metallic Silver



PC-06 Black Jack



PC-07 Warm White



PC-09 Red



PC-12 Cool White



PC-14 Pure Orange



PC-16 Lime



PC-17 Sky Blue



PC-18 Cobalt Blue



PC-22 Charcoal Gray (Matte)



PC-24 Matte Red Clay



PC-25 Cream



PC-26 Mulberry (Matte)



PC-27 Forest Green (Matte)



PC-28 Mustard (Matte)

# GATEWAY™ MEDIA LIFT TABLES

## FEATURES & OPTIONS

Design - busk + hertzog

Gateway™ Media Lift effortlessly transforms meeting tables to create innovative multimedia solutions for communication, presentations and interactive work spaces. At the touch of the remote control or flush mounted switch, the unit raises the monitor screen up from the base cabinet.

### Features:

- Media Lift Tables feature Vista, Rectangle with soft corners and D End top shapes with a single Gateway™ fixed height base.
- Table lengths are available: 60", 72", 84" and 96" with table width 54" and 60" and height 29" & 38" h.
- The depth of the Media cabinet is just 12" as to provide maximum knee space for seating.
- 29" h Media Lift Tables can house a maximum TV size of 43"; 38" h Media Lift Tables can house max. TV size of 55".
- Tables can be specified with a variety of power / data / video / audio solutions for singular and group requirement like all Gateway™ Media Wall Tables.
- Cases are standard with touch catches.
- Locks are standard.
- Remote control is standard for lift operation.
- Cords exit / enter from the floor through the bottom of the case. Contact Customer Service if you require a custom cutout location.

### Finishes/Edges:

- Tops and Media lift cabinet are available in all Nienkämper veneers, standard post forming grade plastic laminate or finger print resistance plastic laminate.
- Fixed Gateway bases are standard with a mirror polished finish.
- Fixed Gateway bases are also offered in all standard Nienkämper powder coat colors.
- 2" Taper edge is standard for Media Lift Tables but self edge is also available.

### Accessories:

- Flush mount lift control is optional.
- A variety of pulls are available.
- Contact Customer Service for option details.

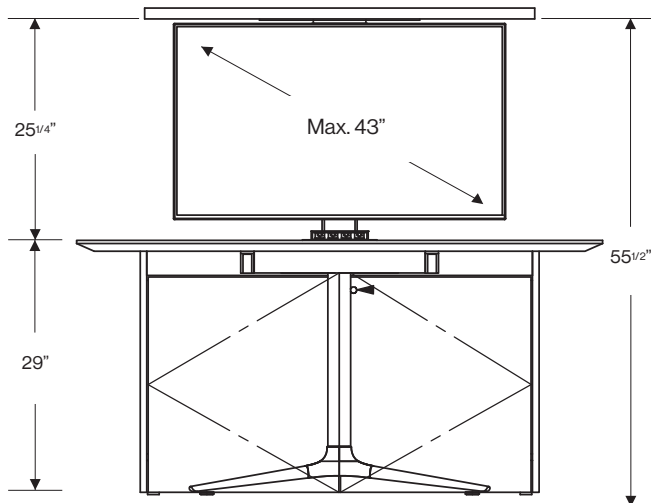

Elevation for 29" h Media Lift Table

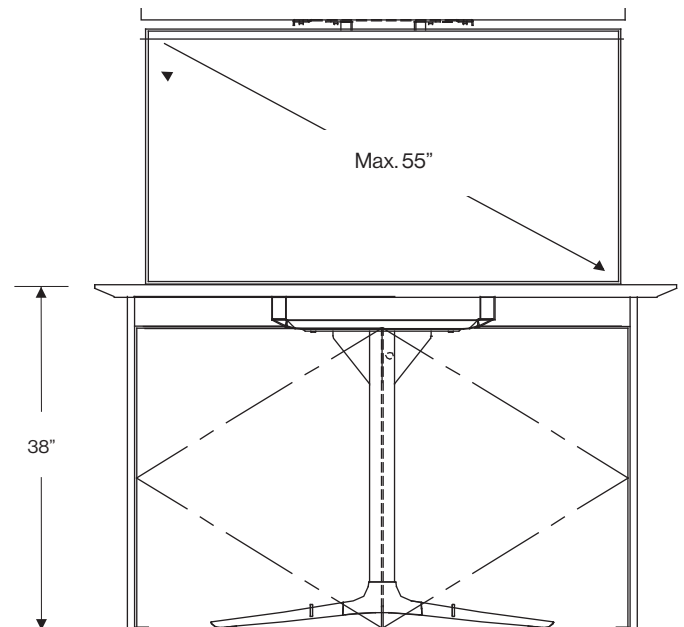

Elevation for 38" h Media Lift Table

# GATEWAY™ MEDIA LIFT TABLES LAYOUT

**TABLE SIZES:**  
Width: 54", 60" | length: 60", 72", 84", 96"

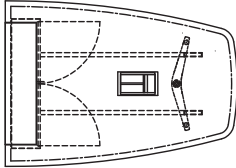

Vista Shape

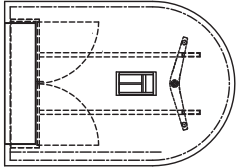

D End Shape

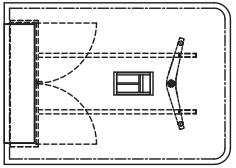

Rectangle Shape

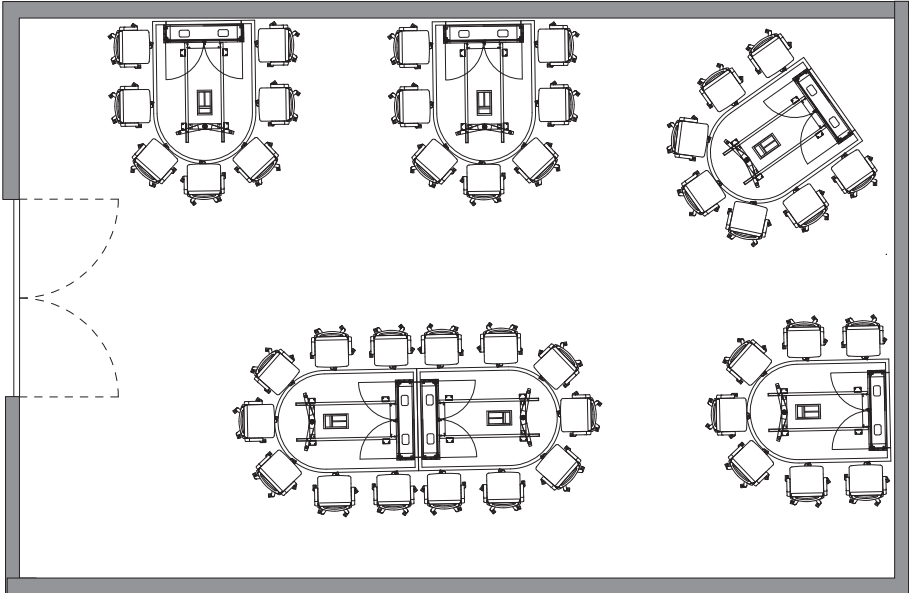

Meeting Room with Multiple Gateway™ Media Lift D End Shape Tables

# GATEWAY™ MEDIA LIFT TABLES

## STANDARD HEIGHT

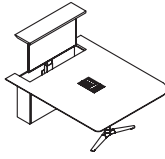
	Model Number	Table Dimensions	Top Finish	List Price
<b>Rectangle Shape with Soft Corners</b> <b>54”d</b> 	43009/2S29	60"L x 54"W x 29"H	Veneer	13,380
	<b>43009/5S29</b>	<b>60"L x 54"W x 29"H</b>	<b>Laminate</b>	<b>12,425</b>
	43010/2S29	72"L x 54"W x 29"H	Veneer	14,035
	<b>43010/5S29</b>	<b>72"L x 54"W x 29"H</b>	<b>Laminate</b>	<b>12,970</b>
	43011/2S29	84"L x 54"W x 29"H	Veneer	14,610
	<b>43011/5S29</b>	<b>84"L x 54"W x 29"H</b>	<b>Laminate</b>	<b>13,465</b>
	43012/2S29	96"L x 54"W x 29"H	Veneer	15,070
	<b>43012/5S29</b>	<b>96"L x 54"W x 29"H</b>	<b>Laminate</b>	<b>13,850</b>

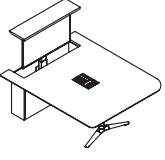
<b>Rectangle Shape with Soft Corners</b> <b>60”d</b> 	43013/2S29	60"L x 60"W x 29"H	Veneer	14,050
	<b>43013/5S29</b>	<b>60"L x 60"W x 29"H</b>	<b>Laminate</b>	<b>13,050</b>
	43014/2S29	72"L x 60"W x 29"H	Veneer	14,455
	<b>43014/5S29</b>	<b>72"L x 60"W x 29"H</b>	<b>Laminate</b>	<b>13,330</b>
	43015/2S29	84"L x 60"W x 29"H	Veneer	15,070
	<b>43015/5S29</b>	<b>84"L x 60"W x 29"H</b>	<b>Laminate</b>	<b>13,850</b>
	43016/2S29	96"L x 60"W x 29"H	Veneer	15,560
	<b>43016/5S29</b>	<b>96"L x 60"W x 29"H</b>	<b>Laminate</b>	<b>14,275</b>

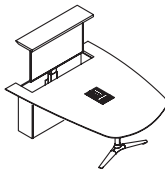
<b>Vista Shape</b> <b>54”d</b> 	43001/2V29	60"L x (34" - 54")W x 29"H	Veneer	13,535
	<b>43001/5V29</b>	<b>60"L x (34" - 54")W x 29"H</b>	<b>Laminate</b>	<b>12,565</b>
	43002/2V29	72"L x (34" - 54")W x 29"H	Veneer	14,210
	<b>43002/5V29</b>	<b>72"L x (34" - 54")W x 29"H</b>	<b>Laminate</b>	<b>13,120</b>
	43003/2V29	84"L x (34" - 54")W x 29"H	Veneer	14,795
	<b>43003/5V29</b>	<b>84"L x (34" - 54")W x 29"H</b>	<b>Laminate</b>	<b>13,630</b>
	43004/2V29	96"L x (34" - 54")W x 29"H	Veneer	15,275
	<b>43004/5V29</b>	<b>96"L x (34" - 54")W x 29"H</b>	<b>Laminate</b>	<b>14,035</b>

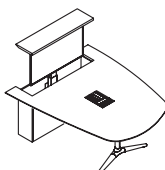
<b>Vista Shape</b> <b>60”d</b> 	43005/2V29	60"L x (37-¾" - 60")W x 29"H	Veneer	13,940
	<b>43005/5V29</b>	<b>60"L x (37-¾" - 60")W x 29"H</b>	<b>Laminate</b>	<b>12,910</b>
	43006/2V29	72"L x (37-¾" - 60")W x 29"H	Veneer	14,655
	<b>43006/5V29</b>	<b>72"L x (37-¾" - 60")W x 29"H</b>	<b>Laminate</b>	<b>13,500</b>
	43007/2V29	84"L x (37-¾" - 60")W x 29"H	Veneer	15,705
	<b>43007/5V29</b>	<b>84"L x (37-¾" - 60")W x 29"H</b>	<b>Laminate</b>	<b>14,395</b>
	43008/2V29	96"L x (37-¾" - 60")W x 29"H	Veneer	16,230
	<b>43008/5V29</b>	<b>96"L x (37-¾" - 60")W x 29"H</b>	<b>Laminate</b>	<b>14,840</b>

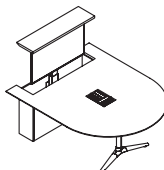
<b>D End Shape</b> <b>54”d</b> 	43017/2D29	60"L x 54"W x 29"H	Veneer	13,770
	<b>43017/5D29</b>	<b>60"L x 54"W x 29"H</b>	<b>Laminate</b>	<b>12,755</b>
	43018/2D29	72"L x 54"W x 29"H	Veneer	14,460
	<b>43018/5D29</b>	<b>72"L x 54"W x 29"H</b>	<b>Laminate</b>	<b>13,335</b>
	43019/2D29	84"L x 54"W x 29"H	Veneer	15,070
	<b>43019/5D29</b>	<b>84"L x 54"W x 29"H</b>	<b>Laminate</b>	<b>13,850</b>
	43020/2D29	96"L x 54"W x 29"H	Veneer	15,565
	<b>43020/5D29</b>	<b>96"L x 54"W x 29"H</b>	<b>Laminate</b>	<b>14,275</b>

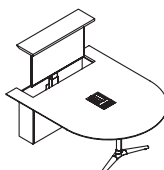
<b>D End Shape</b> <b>60”d</b> 	43021/2D29	60"L x 60"W x 29"H	Veneer	14,460
	<b>43021/5D29</b>	<b>60"L x 60"W x 29"H</b>	<b>Laminate</b>	<b>13,395</b>
	43022/2D29	72"L x 60"W x 29"H	Veneer	14,910
	<b>43022/5D29</b>	<b>72"L x 60"W x 29"H</b>	<b>Laminate</b>	<b>13,720</b>
	43023/2D29	84"L x 60"W x 29"H	Veneer	15,565
	<b>43023/5D29</b>	<b>84"L x 60"W x 29"H</b>	<b>Laminate</b>	<b>14,275</b>
	43024/2D29	96"L x 60"W x 29"H	Veneer	16,075
	<b>43024/5D29</b>	<b>96"L x 60"W x 29"H</b>	<b>Laminate</b>	<b>14,720</b>

- Connectivity devices are to be ordered separately and cost is not reflected in above pricing. Refer to page 153-165 for more information.
- Flat panel monitors and mounting brackets to be supplied by customer and are not included in above pricing.

# GATEWAY™ MEDIA LIFT TABLES

## STANDING HEIGHT

### Rectangle Shape with Soft Corners 60" d

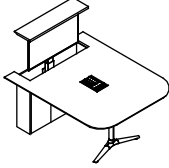

Model Number	Table Dimensions	Top Finish	List Price
43029/2S38	60"L x 60"W x 38"H	Veneer	14,615
<b>43029/5S38</b>	<b>60"L x 60"W x 38"H</b>	<b>Laminate</b>	<b>13,575</b>
43030/2S38	72"L x 60"W x 38"H	Veneer	14,840
<b>43030/5S38</b>	<b>72"L x 60"W x 38"H</b>	<b>Laminate</b>	<b>13,660</b>
43031/2S38	84"L x 60"W x 38"H	Veneer	15,485
<b>43031/5S38</b>	<b>84"L x 60"W x 38"H</b>	<b>Laminate</b>	<b>14,205</b>
43032/2S38	96"L x 60"W x 38"H	Veneer	16,000
<b>43032/5S38</b>	<b>96"L x 60"W x 38"H</b>	<b>Laminate</b>	<b>14,645</b>

### Vista Shape 60" d

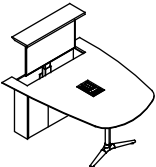

43025/2V38	60"L x (37-¾" - 60")W x 38"H	Veneer	14,175
<b>43025/5V38</b>	<b>60"L x (37-¾" - 60")W x 38"H</b>	<b>Laminate</b>	<b>13,105</b>
43026/2V38	72"L x (37-¾" - 60")W x 38"H	Veneer	16,235
<b>43026/5V38</b>	<b>72"L x (37-¾" - 60")W x 38"H</b>	<b>Laminate</b>	<b>14,850</b>
43027/2V38	84"L x (37-¾" - 60")W x 38"H	Veneer	15,705
<b>43027/5V38</b>	<b>84"L x (37-¾" - 60")W x 38"H</b>	<b>Laminate</b>	<b>14,395</b>
43028/2V38	96"L x (37-¾" - 60")W x 38"H	Veneer	16,230
<b>43028/5V38</b>	<b>96"L x (37-¾" - 60")W x 38"H</b>	<b>Laminate</b>	<b>14,840</b>

### D End Shape 60" d

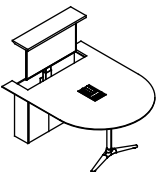

43033/2D38	60"L x 60"W x 38"H	Veneer	15,185
<b>43033/5D38</b>	<b>60"L x 60"W x 38"H</b>	<b>Laminate</b>	<b>14,060</b>
43034/2D38	72"L x 60"W x 38"H	Veneer	15,315
<b>43034/5D38</b>	<b>72"L x 60"W x 38"H</b>	<b>Laminate</b>	<b>14,065</b>
43035/2D38	84"L x 60"W x 38"H	Veneer	16,005
<b>43035/5D38</b>	<b>84"L x 60"W x 38"H</b>	<b>Laminate</b>	<b>14,650</b>
43036/2D38	96"L x 60"W x 38"H	Veneer	16,550
<b>43036/5D38</b>	<b>96"L x 60"W x 38"H</b>	<b>Laminate</b>	<b>15,115</b>

- Connectivity devices are to be ordered separately and cost is not reflected in above pricing. Refer to page 153-165 for more information.
- Flat panel monitors and mounting brackets to be supplied by customer and are not included in above pricing.

## CONNECTIVITY FOR MEDIA WALL / MEDIA LIFT / WALL MOUNTED TABLES

The Extron "Show Me" HDMI cables and VGA cables allows up to 6 users to share information from their tablet or laptop to a monitor.

To share information simply connect your laptop or tablet to the "Show Me" HDMI cable or VGA cable. Press the share button on the "Show Me" cable to display your desktop to the monitor. Images are displayed in High Definition with full Audio.

Collaboration sessions are safe and Secure. The hard-wired signal path protects sensitive content from remote monitoring.

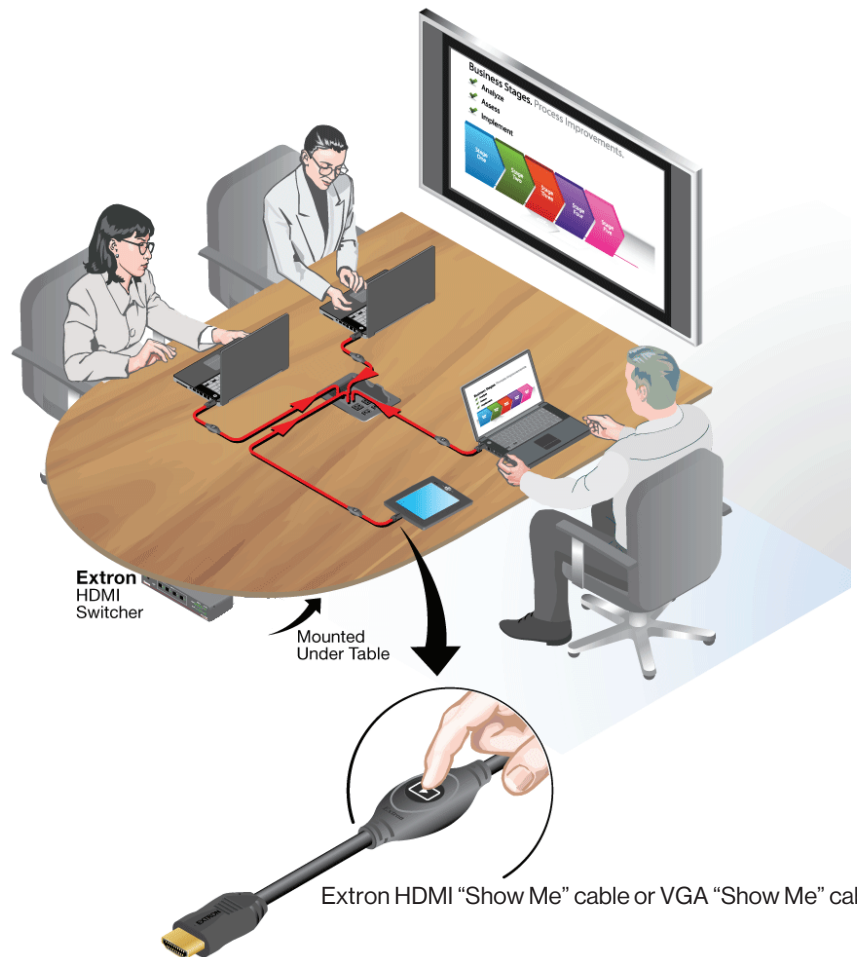

M Series Forum with HDMI "Show Me" cable

## CONNECTIVITY FOR MEDIA WALL / MEDIA LIFT / WALL MOUNTED TABLES

Details of Vox® Forum with Extron "Show Me" HDMI cables only



Vox® Forum, M Series with HDMI "Show Me" cables only

M-1P, 7V, 10X

- 1 split plate w/ 4 holes at ½" dia
- 2 power receptacles
- 1 blank plate
- Surge suppressor
- Wire management U clips
- Cable storage

Also included:

- Teamwork HDMI "Show Me" cables (4 qty)
- Extron SW4 HDMI with EDID Minder switcher
- 12' HDMI cable under table mounting shelf
- UTS 100 primary shelf

List Price            \$5,730

Details of Vox® Forum with Extron "Show Me" HDMI and VGA cables only

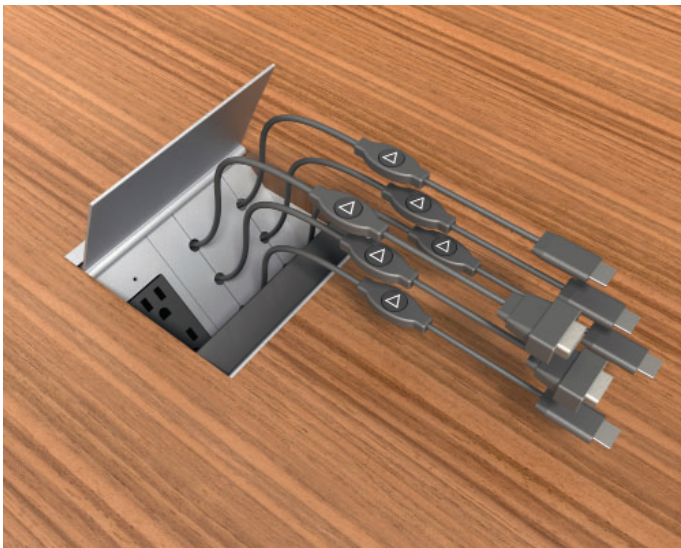

Vox® Forum, M Series with HDMI & VGA "Show Me" cables

M-1P, 11X - 11X

- 2 power receptacles
- Double split plate each with 3 holds at ½" dia.
- Surge suppressor
- Wire management U clips
- Cable storage

Also included:

- Teamwork HDMI "Show Me" cables (4 qty)
- Teamwork VGA "Show Me" cables (2 qty)
- 3.5mm audio cables (2 qty)
- Extron MPS 601 media switcher
- 12' HDMI cable under table mounting shelf
- UTS 100 primary shelf

List Price            \$9,410

See Vox® Forum configurator for additional Vox® Forum configurations ([www.Nienkämper.com/vfc\\_US/vox.html](http://www.Nienkämper.com/vfc_US/vox.html))  
Contact customer service for further information.

# GATEWAY™ TABLES

## STORAGE BASE FOR GATEWAY TABLE

Design - busk + hertzog

Transform any Gateway Wall Mount table into a free standing one by adding a storage element.  
 A Storage Base can be added onto any flat end Gateway table deeper than 36" (both 29"H & 38"H), to provide storage space for supplies, IT and media equipment.

**Features:**

- There are 4 standard storage cases: hinged double door under top, hinged double door at rear, hinge door at end and double door for height adjustable table.
- Doors are standard with touch latches.
- Case interiors have 1 adjustable shelf.
- Wire access is provided by a cut out in bottom of the case.

**Finishes/Edges:**

- Gateway Storage Cases are available in all Nienkämper veneers, standard post forming grade plastic laminate or finger print resistant plastic laminate.

**Accessories:**

- Keyed or electronic door locks can be added to cases.
- A variety of Nienkämper pulls are available.
- Contact Customer Service for option details.

Table Depth at Flat Side	Standard Height Wall Mounted Table (29"h)	Interior Dimension (29"h)	Standing Height Wall Mounted Table (38"h)	Interior Dimension (38"h)
42"d	36"w x 12"d x 27¾"h	34½"w x 10¼"d x 24"h	36"w x 12"d x 36¾"h	34½"w x 10¼"d x 33"h
48"d	42"w x 12"d x 27¾"h	40½"w x 10¼"d x 24"h	42"w x 12"d x 36¾"h	40½"w x 10¼"d x 33"h
54"d	48"w x 12"d x 27¾"h	46½"w x 10¼"d x 24"h	48"w x 12"d x 36¾"h	46½"w x 10¼"d x 33"h
60"d	54"w x 12"d x 27¾"h	52½"w x 10¼"d x 24"h	54"w x 12"d x 36¾"h	52½"w x 10¼"d x 33"h

**How to Order a Gateway Table with Storage Base?**

- To order a storage base element simple:
- 1) Pick the wall mounted Gateway table that suits your requirement from pages 49-62.
  - 2) Select the storage element in the finish you would like from page 81-84 making sure the overall case width is 6" less than your table.
  - 3) Add the two list prices together to determine your pricing.
  - 4) Your final model number will consist of the combined numbers.



Storage Case with hinged double doors under top.



Storage Case with hinged double doors at rear.



Storage Case with hinged door at end.

# GATEWAY™ TABLES

## STORAGE BASE FOR GATEWAY TABLE

### Hinged Door Storage Opening Under Table:

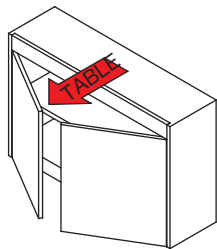

Model Number	Case Dimensions	Finish	List Price
--------------	-----------------	--------	------------

#### For 29" h Table

42410/2OU	36" w x 12" d x 27¾" h	Veneer	2,745
<b>42410/5OU</b>	<b>36" w x 12" d x 27¾" h</b>	<b>Laminate</b>	<b>2,475</b>
42410/7OU	36" w x 12" d x 27¾" h	Paint	2,575

#### For 38" h Table

42411/2OU	36" w x 12" d x 36¾" h	Veneer	3,160
<b>42411/5OU</b>	<b>36" w x 12" d x 36¾" h</b>	<b>Laminate</b>	<b>2,845</b>
42411/7OU	36" w x 12" d x 36¾" h	Paint	2,960

#### For 29" h Table

42412/2OU	42" w x 12" d x 27¾" h	Veneer	3,215
<b>42412/5OU</b>	<b>42" w x 12" d x 27¾" h</b>	<b>Laminate</b>	<b>2,890</b>
42412/7OU	42" w x 12" d x 27¾" h	Paint	3,005

#### For 38" h Table

42413/2OU	42" w x 12" d x 36¾" h	Veneer	3,695
<b>42413/5OU</b>	<b>42" w x 12" d x 36¾" h</b>	<b>Laminate</b>	<b>3,325</b>
42413/7OU	42" w x 12" d x 36¾" h	Paint	3,455

#### For 29" h Table

42414/2OU	48" w x 12" d x 27¾" h	Veneer	3,750
<b>42414/5OU</b>	<b>48" w x 12" d x 27¾" h</b>	<b>Laminate</b>	<b>3,390</b>
42414/7OU	48" w x 12" d x 27¾" h	Paint	3,515

#### For 38" h Table

42415/2OU	48" w x 12" d x 36¾" h	Veneer	4,325
<b>42415/5OU</b>	<b>48" w x 12" d x 36¾" h</b>	<b>Laminate</b>	<b>3,895</b>
42415/7OU	48" w x 12" d x 36¾" h	Paint	4,045

#### For 29" h Table

42416/2OU	54" w x 12" d x 27¾" h	Veneer	4,390
<b>42416/5OU</b>	<b>54" w x 12" d x 27¾" h</b>	<b>Laminate</b>	<b>3,960</b>
42416/7OU	54" w x 12" d x 27¾" h	Paint	4,120

#### For 38" h Table

42417/2OU	54" w x 12" d x 36¾" h	Veneer	5,055
<b>42417/5OU</b>	<b>54" w x 12" d x 36¾" h</b>	<b>Laminate</b>	<b>4,560</b>
42417/7OU	54" w x 12" d x 36¾" h	Paint	4,735

# GATEWAY™ TABLES

## STORAGE BASE FOR GATEWAY TABLE

### Hinged Door Storage Opening to Rear of Table:

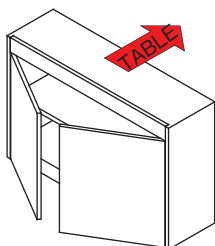

Model Number	Case Dimensions	Finish	List Price
<b>For 29" h Table</b>			
42410/2OR	36" w x 12" d x 27¾" h	Veneer	2,745
<b>42410/5OR</b>	<b>36" w x 12" d x 27¾" h</b>	<b>Laminate</b>	<b>2,475</b>
42410/7OR	36" w x 12" d x 27¾" h	Paint	2,575
<b>For 38" h Table</b>			
42411/2OR	36" w x 12" d x 36¾" h	Veneer	3,160
<b>42411/5OR</b>	<b>36" w x 12" d x 36¾" h</b>	<b>Laminate</b>	<b>2,845</b>
42411/7OR	36" w x 12" d x 36¾" h	Paint	2,960
<b>For 29" h Table</b>			
42412/2OR	42" w x 12" d x 27¾" h	Veneer	3,215
<b>42412/5OR</b>	<b>42" w x 12" d x 27¾" h</b>	<b>Laminate</b>	<b>2,890</b>
42412/7OR	42" w x 12" d x 27¾" h	Paint	3,005
<b>For 38" h Table</b>			
42413/2OR	42" w x 12" d x 36¾" h	Veneer	3,695
<b>42413/5OR</b>	<b>42" w x 12" d x 36¾" h</b>	<b>Laminate</b>	<b>3,325</b>
42413/7OR	42" w x 12" d x 36¾" h	Paint	3,455
<b>For 29" h Table</b>			
42414/2OR	48" w x 12" d x 27¾" h	Veneer	3,750
<b>42414/5OR</b>	<b>48" w x 12" d x 27¾" h</b>	<b>Laminate</b>	<b>3,390</b>
42414/7OR	48" w x 12" d x 27¾" h	Paint	3,515
<b>For 38" h Table</b>			
42415/2OR	48" w x 12" d x 36¾" h	Veneer	4,325
<b>42415/5OR</b>	<b>48" w x 12" d x 36¾" h</b>	<b>Laminate</b>	<b>3,895</b>
42415/7OR	48" w x 12" d x 36¾" h	Paint	4,045
<b>For 29" h Table</b>			
42416/2OR	54" w x 12" d x 27¾" h	Veneer	4,390
<b>42416/5OR</b>	<b>54" w x 12" d x 27¾" h</b>	<b>Laminate</b>	<b>3,960</b>
42416/7OR	54" w x 12" d x 27¾" h	Paint	4,120
<b>For 38" h Table</b>			
42417/2OR	54" w x 12" d x 36¾" h	Veneer	5,055
<b>42417/5OR</b>	<b>54" w x 12" d x 36¾" h</b>	<b>Laminate</b>	<b>4,560</b>
42417/7OR	54" w x 12" d x 36¾" h	Paint	4,735

# GATEWAY™ TABLES

## STORAGE BASE FOR GATEWAY™ TABLE

Hinged Door  
Storage  
End Door RH / LH:

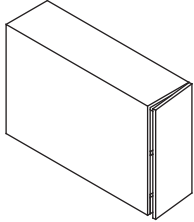

Model Number	Case Dimensions	Finish	List Price	Model Number	Case Dimensions	Finish	List Price
<b>RIGHT HAND DOOR</b>				<b>LEFT HAND DOOR</b>			
<b>For 29" h Table</b>				<b>For 29" h Table</b>			
42418/2EDR	36" w x 12" d x 27¾" h	Veneer	2,610	42418/2EDL	36" w x 12" d x 27¾" h	Veneer	2,610
<b>42418/5EDR</b>	<b>36" w x 12" d x 27¾" h</b>	<b>Laminate</b>	<b>2,360</b>	<b>42418/5EDL</b>	<b>36" w x 12" d x 27¾" h</b>	<b>Laminate</b>	<b>2,360</b>
42418/7EDR	36" w x 12" d x 27¾" h	Paint	2,440	42418/7EDL	36" w x 12" d x 27¾" h	Paint	2,440
<b>For 38" h Table</b>				<b>For 38" h Table</b>			
42419/2EDR	36" w x 12" d x 36¾" h	Veneer	3,000	42419/2EDL	36" w x 12" d x 36¾" h	Veneer	3,000
<b>42419/5EDR</b>	<b>36" w x 12" d x 36¾" h</b>	<b>Laminate</b>	<b>2,705</b>	<b>42419/5EDL</b>	<b>36" w x 12" d x 36¾" h</b>	<b>Laminate</b>	<b>2,705</b>
42419/7EDR	36" w x 12" d x 36¾" h	Paint	2,815	42419/7EDL	36" w x 12" d x 36¾" h	Paint	2,815
<b>For 29" h Table</b>				<b>For 29" h Table</b>			
42420/2EDR	42" w x 12" d x 27¾" h	Veneer	3,060	42420/2EDL	42" w x 12" d x 27¾" h	Veneer	3,060
<b>42420/5EDR</b>	<b>42" w x 12" d x 27¾" h</b>	<b>Laminate</b>	<b>2,750</b>	<b>42420/5EDL</b>	<b>42" w x 12" d x 27¾" h</b>	<b>Laminate</b>	<b>2,750</b>
42420/7EDR	42" w x 12" d x 27¾" h	Paint	2,860	42420/7EDL	42" w x 12" d x 27¾" h	Paint	2,860
<b>For 38" h Table</b>				<b>For 38" h Table</b>			
42421/2EDR	42" w x 12" d x 36¾" h	Veneer	3,510	42421/2EDL	42" w x 12" d x 36¾" h	Veneer	3,510
<b>42421/5EDR</b>	<b>42" w x 12" d x 36¾" h</b>	<b>Laminate</b>	<b>3,165</b>	<b>42421/5EDL</b>	<b>42" w x 12" d x 36¾" h</b>	<b>Laminate</b>	<b>3,165</b>
42421/7EDR	42" w x 12" d x 36¾" h	Paint	3,285	42421/7EDL	42" w x 12" d x 36¾" h	Paint	3,285
<b>For 29" h Table</b>				<b>For 29" h Table</b>			
42422/2EDR	48" w x 12" d x 27¾" h	Veneer	3,580	42422/2EDL	48" w x 12" d x 27¾" h	Veneer	3,580
<b>42422/5EDR</b>	<b>48" w x 12" d x 27¾" h</b>	<b>Laminate</b>	<b>3,225</b>	<b>42422/5EDL</b>	<b>48" w x 12" d x 27¾" h</b>	<b>Laminate</b>	<b>3,225</b>
42422/7EDR	48" w x 12" d x 27¾" h	Paint	3,340	42422/7EDL	48" w x 12" d x 27¾" h	Paint	3,340
<b>For 38" h Table</b>				<b>For 38" h Table</b>			
42423/2EDR	48" w x 12" d x 36¾" h	Veneer	4,110	42423/2EDL	48" w x 12" d x 36¾" h	Veneer	4,110
<b>42423/5EDR</b>	<b>48" w x 12" d x 36¾" h</b>	<b>Laminate</b>	<b>3,700</b>	<b>42423/5EDL</b>	<b>48" w x 12" d x 36¾" h</b>	<b>Laminate</b>	<b>3,700</b>
42423/7EDR	48" w x 12" d x 36¾" h	Paint	3,845	42423/7EDL	48" w x 12" d x 36¾" h	Paint	3,845
<b>For 29" h Table</b>				<b>For 29" h Table</b>			
42424/2EDR	54" w x 12" d x 27¾" h	Veneer	4,170	42424/2EDL	54" w x 12" d x 27¾" h	Veneer	4,170
<b>42424/5EDR</b>	<b>54" w x 12" d x 27¾" h</b>	<b>Laminate</b>	<b>3,765</b>	<b>42424/5EDL</b>	<b>54" w x 12" d x 27¾" h</b>	<b>Laminate</b>	<b>3,765</b>
42424/7EDR	54" w x 12" d x 27¾" h	Paint	3,920	42424/7EDL	54" w x 12" d x 27¾" h	Paint	3,920
<b>For 38" h Table</b>				<b>For 38" h Table</b>			
42425/2EDR	54" w x 12" d x 36¾" h	Veneer	4,800	42425/2EDL	54" w x 12" d x 36¾" h	Veneer	4,800
<b>42425/5EDR</b>	<b>54" w x 12" d x 36¾" h</b>	<b>Laminate</b>	<b>4,335</b>	<b>42425/5EDL</b>	<b>54" w x 12" d x 36¾" h</b>	<b>Laminate</b>	<b>4,335</b>
42425/7EDR	54" w x 12" d x 36¾" h	Paint	4,500	42425/7EDL	54" w x 12" d x 36¾" h	Paint	4,500

# TERMS AND CONDITIONS OF SALE

---

## PRICES

All prices are list prices, FOB our Toronto Factory- freight charges are extra. Packing and/ or crating is available, if required, upcharges apply.

Due to existing conditions in regard to cost of labor and materials, we reserve the right to change prices without notice.

## TERMS

Net 30 days from date of invoice to accredited buyers. Two per cent (2%) interest charged monthly on overdue accounts. Deposit of 50% is required with order. Terms will be established upon credit evaluation. Due to delays in processing references, first orders may be treated as C.B.D. orders.

## ORDER CONFIRMATION

Orders are accepted upon issuance of our order confirmation and are subject to the terms set forth therein; notwithstanding any variance from the terms of the buyer's order form.

Nienkämper is not liable for any delay or failure to deliver caused by labor or transportation difficulties, accidents, acts of God, failure of sources of supply, or other causes beyond our control, and changes will affect the delivery date.

## CHANGE OF ORDERS OR CANCELLATIONS

Changes or cancellations are subject to our ability to conform. A charge will be levied against canceled or changed orders based on costs already incurred by Nienkämper. All changes must be in writing and submitted on a revised purchase order. Changes will affect the delivery date.

## STORAGE

If goods cannot be accepted when ready, we may transfer them to storage (which is to be deemed as delivery for invoice purposes). The customer accepts risks and will be charged at prevailing rates.

## FREIGHT

All prices are list prices, FOB our Toronto Factory- freight charges are extra.

Packing and/or crating are available, if required, upcharges apply.

## CLAIMS

All furniture is given to the carrier and signed for in good condition. It is the responsibility of the receiver to sign for the goods in the presence of the carrier and note the condition in which they are received. Freight claims should be filed with the carrier.

## WARRANTY

There are no express or implied warranties, conditions and obligations of the manufacturer, whether statutory or otherwise that extend beyond the description on the face hereof. Our furniture is made to the highest standard and is warranted free from defects of material and workmanship for five years from the date of delivery. During the warranty period we will repair or replace such merchandise as shall prove to be defective, during normal usage in accordance with manufacturer's specifications. The manufacturer shall not be liable for defect wholly attributable to normal manufacturing process. Replacement or repair of the Product shall be the sole remedy of the Customer, and the manufacturer shall not be liable for any direct, indirect, incidental, or consequential loss or damage suffered by the Customer by reason of any defect in workmanship or manufacture of the Product or inability to use the Product. Moreover, this warranty does not cover accidental damage, abuse, alteration, ordinary wear and tear of Goods, negligence and misuse nor variations over which we have no control such as heat or humidity or damage to which the Goods are connected that is not attributable to the failure of the goods themselves. This warranty is null and void when the product is installed with hardware other than that supplied and/or when installed differently than recommended in the installation guide. Modification to the product or hardware may result in failure of the product and cause damage and/or injury.

## WOOD FINISHES

Nienkämper offers a wide variety of standard light finishes on cherry, mahogany and figured anagre wood veneers, and a clear natural finish on figured anagre, figured sycamore, maple, bird's eye maple and curly maple.

Light finishes do not mask the grain and other characteristics of each wood species. It is important to understand that pieces of the same type of wood will not look identical when a light finish is used. The appearance of the finish will also depend on the natural color of the veneer. Cherry darkens over time as the wood ages. Pin knots and gum pockets are inherent traits.

Wood is a naturally variable raw material; its variances are not within the furniture manufacturer's control and are therefore not considered defects under this warranty.