

# nienkämper

## **GATEWAY™**

### TASK TABLES



**2026**

Prices shown are List Prices, FOB our Toronto  
Factory- freight charges are extra. Packing and/  
or crating is available, if required, upcharges apply.

## GATEWAY™ COLLECTION FINISHES – VENEER

All wood surfaces are protected with a durable polyurethane clear lacquer with UV inhibitor. This finish is known for its exceptional durability, as well as abrasion, chemical, impact and scratch resistance. Standard sheen level is 45 degrees. Optional matte, 5, 10 and 35 degree sheen levels are available on request at no additional cost.

Wood Species	Order Code	Veneer/Stain	Upcharge
Maple	F-01	Natural Maple	No upcharge applies.
	F-02	Natural Curly Maple - Rotary Cut	Add 15%.
	F-03	Natural Bird's Eye Maple - Rotary Cut	Call Customer Service for pricing.
	F-04	Maple Stained Pear	No upcharge applies.
Cherry	F-05	Natural Cherry	No upcharge applies.
	F-06	Standard Cherry	No upcharge applies.
	F-07	Cherry Stained Amber	No upcharge applies.
	F-08	Cherry Stained Auburn	No upcharge applies.
	F-09	Cherry Stained Burgundy	No upcharge applies.
Mahogany	F-10	Light Mahogany	No upcharge applies.
	F-11	Medium Mahogany	No upcharge applies.
	F-12	Dark Mahogany	No upcharge applies.
	F-13	Red Mahogany	No upcharge applies.
Anagré	F-14	Natural Figured Anagré - Qtr. Cut Book-Match	Add 15%.
	F-15	Figured Anagré Stained Amber - Qtr. Cut Book-Match	Add 15%.
Sycamore	F-16	Natural Figured Sycamore - Qtr. Cut Book-Match	Add 15%.
Walnut	F-17	Burnt Walnut	No upcharge applies.
	F-19	Natural Walnut- Flat Cut Book-Match	No upcharge applies.
	F-19FM	Natural Walnut- Flat Cut Book-Match (matte sheen)	No upcharge applies.
	F-27F	Creamy Walnut- Flat Cut Book-Match (10° sheen)	No upcharge applies.
	F-27R	Creamy Walnut - Rift Cut Slip-Match (10° sheen)	Add 5%
	F-28	Tawny Walnut	No upcharge applies.
	F-31FM	Autumn Walnut- Flat Cut Book-Match (matte sheen)	No upcharge applies.
	F-31RM	Autumn Walnut - Rift Cut Slip-Match (matte sheen)	Add 5%
Oak	F-18F	Natural White Oak - Flat Cut Book-Match (10° sheen)	No upcharge applies.
	F-18R	Natural White Oak - Rift Cut Slip-Match (10° sheen)	Add 5%
	F-26	Charcoal Ash On Oak- Flat Cut Book- Match (10° sheen)	No upcharge applies.
	F-29F	Smoky Oak - Flat Cut Book-Match	No upcharge applies.
	F-29R	Smoky Oak - Rift Cut Slip-Match	Add 5%
	F-29FM	Smoky Oak - Flat Cut Book-Match (matte sheen)	No upcharge applies.
	F-29RM	Smoky Oak - Rift Cut Slip-Match (matte sheen)	Add 5%
	F-30FM	Whisper White Oak - Flat Cut Book-Match (matte sheen)	No upcharge applies.
	F-30RM	Whisper White Oak - Rift Cut Slip-Match (matte sheen)	Add 5%
	F-32FM	Cotton White Oak - Flat Cut Book-Match (matte sheen)	No upcharge applies.
F-32RM	Cotton White Oak - Rift Cut Slip-Match (matte sheen)	Add 5%	
Sapele – Ribbon Stripe	F-20	Natural Ribbon Strip Sapele - Qtr. Cut Slip-Match	No upcharge applies.
Moabi (Cherry substitute)	F-21	Natural Moabi - Quarter - Qtr. Cut Book-Match	No upcharge applies.
Cape Coast Walnut	F-22	Dark Cape Coast Walnut - Qtr. Cut Slip-Match	No upcharge applies.
	F-23	Natural Cape Coast Walnut - Qtr. Cut Slip-Match	No upcharge applies.
	F-23	Natural Cape Coast Walnut - Qtr. Cut Slip-Match	No upcharge applies.
Ash	F-25	Slate Gray Ash - Qtr. Cut Slip-Match	No upcharge applies.

### VENEER GRAIN OPTIONS

Nienkämper products utilize the best quality veneers available, and, combined with Nienkämper's patented veneering systems, create work environments of incredible quality and beauty.

All veneer furniture comes standard with flat cut book-match veneer; flat cut slip-match veneer can also be specified. Quarter cut slip-match and quarter cut book-match veneers are available at a 5% upcharge. Figured Anagré and Figured Sycamore veneers are Quarter cut book-matched. Bird's Eye Maple and Curly Maple are rotary cut. Facet Edge, Taper edge, Flowform, Camber and Self edge tops with veneer are manufactured with a solid wood edge. All edges are then veneer wrapped to create a seamless profile top.

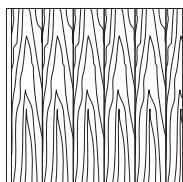

Standard V1  
Flat Cut Book-Match

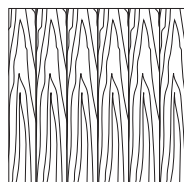

Flat Cut Slip-Match V2

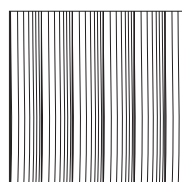

Quarter Cut Slip-Match V3  
Add 5%

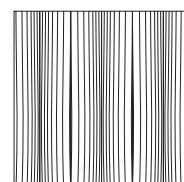

Quarter Cut Book-Match V4  
Add 5%

## GATEWAY™ COLLECTION FINISHES – PLASTIC LAMINATES

Wood grain plastic laminate surfaces are available on table tops with Facet, Taper and Self edges.

These tops are manufactured with a solid wood edge that is applied prior to the laminate top surface. This method conceals the thickness of the wood edge, while providing the durability required. Wood edges are selected that most closely resemble both the species and the color of the laminate chosen

Nienkämper has pre-selected a number of standard wood grain plastic laminates that represent a cross section of both color and species. Simply include the order code with the model number to make these selections. Alternatively wood grain plastic laminates selected outside of Nienkämper’s standard selection can be made by specifying the manufacturer as well as the description and model number of the laminate at the time of order.

Wood Grain Plastic Laminate Surfaces	Order Code	Manufacturer #	Finish
Hardrock Maple	WL2	Pionite WM791-SD	Textured/Suede
Monticello Maple	WL5	Wilsonart 7925-38	Fine Velvet Texture
Fusion Maple	WL13	Wilsonart 7909-60	Matte
New Age Oak	WL14	Wilsonart 7938-38	Fine Velvet Texture
Wild Cherry	WL18	Wilsonart 7054-60	Matte
River Cherry	WL19	Wilsonart 7937-38	Fine Velvet Texture
Montana Walnut	WL20	Wilsonart 7110T-78	Fine Grain
Skyline Walnut	WL26	Wilsonart 7964K-12	Soft Grain
Continental Walnut	WL-29	Wilsonart 8232K-05	Timbergrain
Neo Walnut	WL-30	Wilsonart 7991-38	Fine Velvet Texture
Walnut Heights	WL-31	Wilsonart 7965K-12	Soft Grain
Grayed Oak	WL-32	Formica 5791-PG	Pure Grain Texture
Millennium Oak	WL-33	Formica 5887-58	Matte
Aged Ash	WL-34	Formica 8844-WR	Woodbrush
Lowell Ash	WL-35	Wilsonart 7994-38	Fine Velvet Texture
Natural Ash	WL-36	Formica 8843-WR	Woodbrush
Norwegian Ash	WL-37	Wilsonart 8241-38	Fine Velvet Texture
Weathered Ash	WL-38	Formica 8842-WR	Woodbrush
Smoky Brown Pear	WL-39	Formica 5488-26	Oiled Wood
Studio Teak	WL-40	Wilsonart 7960K-18	Linearity
Fawn Cypress	WL-41	Wilsonart 8208K-16	Casual Rustic
Landmark Wood	WL-42	Wilsonart 7981K-12	Soft Grain
Natural Cerise	WL-43	Formica 8863-58	Matte
Natural Recon	WL-44	Wilsonart 7996-38	Fine Velvet Texture
Pecan Woodline	WL-45	Formica 5883-58	Matte

To specify the wood grain laminate required simply add the Order Code WL\_ to the model number of the product.

Samples and specific technical data is available from your local sales representative or by contacting Nienkämper’s Customer Service department at **800.668.9318**.

## GATEWAY™ COLLECTION FINISHES – PLASTIC LAMINATES

### COLORED P-LAM

Nienkämper has a number of solid color laminates to choose from, simply include the order code with the model number to make these selections. Alternatively plastic laminates selected outside of Nienkämper's standard selection can be made by specifying the manufacturer as well as the description and model number of the laminate at the time of order. Contact customer service for pricing.

Colored Plastic Laminates Surface	Order Code	Manufacturer #	Finish
Gray (Nienkämper - Light Gray/Putty)	CL-01	Wilsonart 1500-60	Matte
Plantinum Gray (Nienkämper - Medium Grey/Clay)	CL-02	Nevamar S6023T	Textured
Slate Grey (Nienkämper - Dark Grey)	CL-03	Wilsonart D91-60	Matte
Black	CL-04	Wilsonart 1595-60	Matte
Angel White	CL-05	Pionite SW-826SD	Textured/Suede
Frosty White	CL-06	Wilsonart 1573-60	Matte
White (for writable surface)	CL-07	Formica 949-90	Gloss

The unique composition offers extraordinary features coupled with a unique user experience. These include an ultra matte surface (eliminating glare), an ultra sofa feel, an anti-fingerprint surface, thermal healing of micro-scratches, increased durability as well as anti-bacterial and mold-resistant properties.

**Edgeband** matching all Fingerprint Resistant Plastic Laminate colors is only available when specifying a Taper edge. For Self edge tops 1" and 1 1/4" thick, matching edgeband are only available in Black (RL-01) and White (RL-03). When a matching edgeband is not available, the specified surface laminate is used on the edge. **Contact Customer Service for more details 800.668-9318.**

There is a 20% upcharge on our standard plastic laminate table pricing for Fingerprint Resistant Plastic Laminate.

Colored "Fingerprint Resistant" Plastic Laminate Surface	Order Code	Finish
Black	RL-01	Matte
Gray	RL-02	Matte
White	RL-03	Matte
Sand	RL-04	Matte
Brown	RL-05	Matte
Clay	RL-06	Matte
Beige	RL-07	Matte
Ash	RL-08	Matte
Smoke	RL-09	Matte

Edgeband to Match with Colored "Fingerprint Resistant" Plastic Laminate	Thickness	Order Code
Black	3/4", 1", 1-1/4"	RE-01
Gray	3/4"	RE-02
White	3/4", 1", 1-1/4"	RE-03
Sand	3/4"	RE-04
Brown	3/4"	RE-05
Clay	3/4"	RE-06
Beige	3/4"	RE-07
Ash	3/4"	RE-08
Smoke	3/4"	RE-09

# GATEWAY™ COLLECTION FINISHES – PLASTIC LAMINATES

---

## COLORED P-LAM

Both Taper and Self edge profiles are available with a colored laminate top.

**Laminate edging on Taper tops.** Edging will match the top surface and is applied before the surface laminate. By applying the laminate in this way, the seam is positioned horizontally, which makes it much less conspicuous and more durable.

**Wood edging** on Self and Taper Edge tops are applied before the laminate. By applying the wood edge in this way, the wood edge thickness is concealed, while providing the durability required. Wood species and finishes for edging can be selected from page 8.

For laminates specified outside of Nienkämper's standard selection, specify the manufacturer as well as the description and model number of the laminate selected at the time of order. For Facet edge tops, the laminate must be a post-forming grade.

**Translucent edging** on Self and Taper edge tops is applied after the surface laminate. The translucent edge is very durable. Clear translucent edge provides a good match with most white-colored laminates, while a silver translucent edge provides a metallic look and contrast to colored plastic laminates.

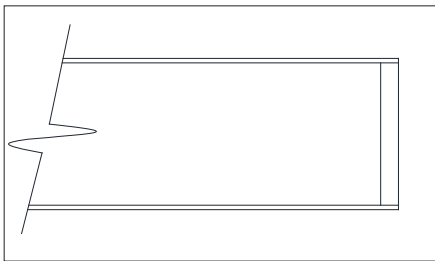

Wood Edge Detail

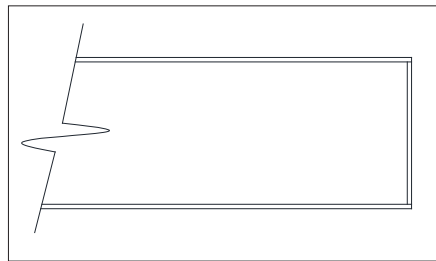

Laminate Edge Detail

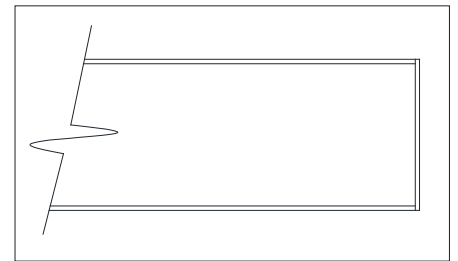

Edge Band Detail

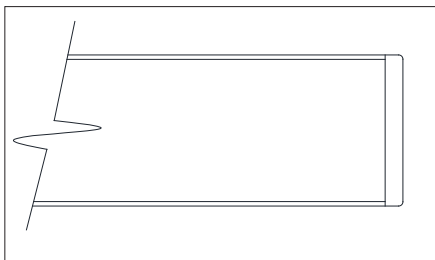

Translucent Edge Detail

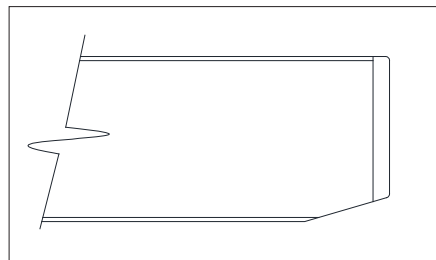

1 1/4" Thick Self Edge with Translucent Edge Detail

## Powder Coat Paint Finish

Powder coat paint is a premium finish used for its exceptional durability and refined appearance. Applied as a dry powder and cured under heat, it forms a tough, uniform surface that resists chipping, scratching, and fading—ideal for commercial environments. Nienkämper offers a curated palette of 18 color variations to suit any project.



PC-01 Nienkämper Silver



PC-02 Champagne



PC-03 Light Bronze



PC-04 Standard (Dark) Bronze



PC-05 Metallic Silver



PC-06 Black Jack



PC-07 Warm White



PC-09 Red



PC-12 Cool White



PC-14 Pure Orange



PC-16 Lime



PC-17 Sky Blue



PC-18 Cobalt Blue



PC-22 Charcoal Gray (Matte)



PC-24 Matte Red Clay



PC-25 Cream



PC-26 Mulberry (Matte)



PC-27 Forest Green (Matte)



PC-28 Mustard (Matte)

# UPHOLSTERY DETAILS

**CUSTOMER'S OWN MATERIALS (COM):**

Nienkämper reserves the right to determine the suitability of a particular COM on our furniture. If we determine, in our judgment, that the COM is inappropriate for use on a particular product we will notify the customer. If you have any questions on the appropriateness of your COM please submit a sample to Customer Service prior to your order.

**KNOLL TEXTILES:**

All Nienkämper seating available in fabric includes pricing for four grades of fabric, see the Knoll Textiles grade columns throughout this book. All fabric orders should be made when ordering the furniture. For Knoll Textiles samples contact the Knoll Textiles Customer Service department at 1.866.565.5858.

All yardage requirements are noted for each model number and option, refer to the pricing charts in this book. All yardage requirements shown in our price list are based on 54" plain material. Fabrics which have a repeat that must be matched, or are less than 54" wide, will require more yardage. Check with Customer Service before ordering. There may be yardage savings for quantity orders of the same model. Check with Customer Service before ordering. ALL COM WILL BE CUT AND APPLIED AT OUR DISCRETION UNLESS SPECIAL CUTTING INSTRUCTIONS ARE INCLUDED IN WRITING WITH THE ORDER. FABRIC PATTERNS SHOULD BE IDENTIFIED AS APPLIED VERTICALLY OR HORIZONTALLY ON A FRAME. WE CANNOT BE HELD RESPONSIBLE FOR RECEIPT OF DEFECTIVE FABRIC AS WE APPLY ALL COM AS FIRST QUALITY GOODS.

Fabric	Plain	2" - 14"	15" - 24"	25" - 27"	28" - 36"
Width	Fabric	Repeat	Repeat	Repeat	Repeat
54"	0%	10%	15%	20%	25%
50"	10%	20%	25%	30%	35%
48"	15%	25%	30%	35%	40%
45"	40%	50%	55%	60%	65%
36"	50%	60%	65%	70%	75%

We cannot be held responsible if yardage supplied is insufficient to complete an order.

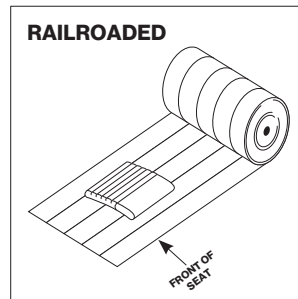
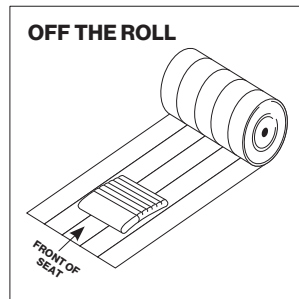

**CUSTOMER'S OWN LEATHER:**

All furniture listed in this price list that is available with leather has pricing in COL, refer to the COL column throughout this book. Leather is applied to avoid scars, however, some markings are inherent in this natural material. Square footage requirements are based on cow hides measuring 50 sq.ft. per hide. Consult Nienkämper's Customer Service Department for square footage requirements before ordering when using hides that do not meet these requirements. Application instructions must accompany all COL orders. In the absence of these instructions Nienkämper will determine the best method of upholstery.

**SHIPPING YOUR MATERIALS:**

For Canada  
Customer supplied material must be sent prepaid to:

Nienkämper International, Inc.  
257 Finchdene Square  
Toronto, Ontario  
Canada M1X 1B9

From all locations outside of Canada  
Customer supplied material must be sent prepaid to:

Willson International Limited  
c/o Nienkämper  
257 Finchdene Square  
Toronto, Ontario  
Canada M1X 1B9

All packages must include a copy of a commercial invoice showing the exact yardage, value and fibre content of the fabric and must indicate our order confirmation number, or customer's purchase order number, and the furniture for which it is intended.

# UPHOLSTERY DETAILS

An index of KnollTextiles fabric follows. Contact KnollTextiles customer service at 1.800.237.1625 for an updated listing. For fabric not graded in, please contact customer service for pricing.

## ALPHABETICAL INDEX:

Category 1	
Fabric Name	Pattern #
Attire	466933
Boundary*	466735
Brigadoon*	466914
Chameleon*	466929
Commuter Cloth	466879
Contour*	466950
Cozy Cord*	466938
Crossroad	466672
Delite	466730
Diva	466722
Dottie	466799
Facet*	466804
Ferry	466850
Hourglass	466846
Infinite	466734
Instinct	466921
Journey	466866
Keaton	466851
Knoll Hopsack	466729
Little Devil	466916
Oh La La	466671
Olympia	466808
Plaid On*	466947
Prairie*	466762
Puff	466726
Shadow Play*	466759
Sonnet	466909
Summit	466694
Tinge*	466721
Topos*	466800
Utopia*	466867
Vast*	466945
Venue	466756
Vibe II*	466718
Westwood*	466757
Wild Thing*	466779
Winnow*	466960

Category 2	
Fabric Name	Pattern #
Atlas*	466702
Aurora, 1985	466954
Buzz	466719
Caliper*	466804
Circle Point*	466942
Cleo	466910
Code	466736
Color Field*	466712
Currents*	466951
Dactyl*	466673
Day Tripper	466913
Durand*	466895
Entwine	466937
Flower Power	466946
Greenwich*	466878
Homage*	466943
Hummingbird	466956
Island*	466765
Kiln*	466965
Knoll Felt	466830
Off the Grid	466725
Palisade*	466763
Pathway*	466941
Pico	466968
Placid*	466949
Premier*	466920
Prestini*	466953
Pullman	466917
Rebel	466922
Retreat*	466944
Seurat	466811
Smart*	466853
Tempest	466724
Utmost II	466931
Vice Versa*	466925
Whip*	466842
Woodland II*	466723
Wow Factor	466720

Category 3	
Fabric Name	Pattern #
Aegean	466769
Alter Ego	466792
Arrondissement	466711
Biscayne	466890
Cameo	466674
Circa	466753
Classic Boucle	466777
Color Collage	466716
Eclat Weave	466773
Fancy Twill	466717
Imprint	466923
In Stitches	466908
It's Complicated*	466771
Looped In	466948
Mococco, 1966	466967
Modern Tweed	466795
Nature Walk*	466770
Rivers	466806
Sherman	466841
Texnet*	466760
Vert	466955

Category 4	
Fabric Name	Pattern #
Altiplano	466974
Amore	466905
Arezzo	466776
Atelier	466882
Catwalk	466907
Chiseled	466919
Dapper	466803
Firefly	466901
Floressence	466924
In Step	466928
Rivington	466939
Stretch Appeal	466871
Striae Stripe	466930
Stripe It*	466683
Tara	466926
Ultrasuede	466793
Utrillo	466945

Not Graded In	
Fabric Name	Pattern #
Byron	466710
Cato	466862
Chic	466934
Cummings	466709
Digi Velvet	466816
Daily	466807
Dynamic	466845
Guisse	466727
Ita	466693
Knoll Velvet	466780
Limani	466906
Lowell	466707
North Island	466704
Sandis	466915

NOTE: Fabric with "\*" is Bleach Cleanable with diluted household bleach.

# FABRIC DETAILS

An index of KnollTextiles follows. Contact KnollTextiles customer service at 1.800.237.1625 for an updated listing. For fabric not graded in, please contact customer service for pricing.

## NUMERICAL INDEX:

Category 1	
Fabric Name	Pattern #
Oh La La	466671
Crossroad	466672
Summit	466694
Vibe II*	466718
Tinge*	466721
Diva	466722
Puff	466726
Knoll Hopsack	466729
Delite	466730
Infinite	466734
Boundary*	466735
Venue	466756
Westwood*	466757
Shadow Play*	466759
Prairie*	466762
Wild Thing*	466779
Dottie	466799
Topos*	466800
Facet*	466804
Olympia	466808
Hourglass	466846
Ferry	466850
Keaton	466851
Journey	466866
Utopia*	466867
Commuter Cloth	466879
Sonnet	466909
Brigadoon*	466914
Little Devil	466916
Instinct	466921
Chameleon*	466929
Attire	466933
Cozy Cord*	466938
Vast*	466945
Plaid On*	466947
Contour*	466950
Winnow*	466960

Category 2	
Fabric Name	Pattern #
Dactyl*	466673
Atlas*	466702
Color Field*	466712
Buzz	466719
Wow Factor	466720
Woodland II*	466723
Tempest	466724
Off the Grid	466725
Code	466736
Palisade*	466763
Island*	466765
Caliper*	466804
Seurat	466811
Knoll Felt	466830
Whip*	466842
Smart*	466853
Greenwich*	466878
Durand*	466895
Cleo	466910
Day Tripper	466913
Pullman	466917
Premier*	466920
Rebel	466922
Vice Versa*	466925
Utmost II	466931
Entwine	466937
Pathway*	466941
Circle Point*	466942
Homage*	466943
Retreat*	466944
Flower Power	466946
Placid*	466949
Currents*	466951
Prestini*	466953
Aurora, 1985	466954
Hummingbird	466956
Kiln*	466965
Pico	466968

Category 3	
Fabric Name	Pattern #
Cameo	466674
Arrondissement	466711
Color Collage	466716
Fancy Twill	466717
Circa	466753
Texnet*	466760
Aegean	466769
Nature Walk*	466770
It's Complicated*	466771
Eclat Weave	466773
Classic Boucle	466777
Alter Ego	466792
Modern Tweed	466795
Rivers	466806
Sherman	466841
Biscayne	466890
In Stitches	466908
Imprint	466923
Looped In	466948
Vert	466955
Mococco, 1966	466967

Category 4	
Fabric Name	Pattern #
Stripe It*	466683
Arezzo	466776
Ultrasuede	466793
Dapper	466803
Stretch Appeal	466871
Atelier	466882
Firefly	466901
Amore	466905
Catwalk	466907
Chiseled	466919
Florescence	466924
Tara	466926
In Step	466928
Striae Stripe	466930
Rivington	466939
Utrillo	466945
Altiplano	466974

Not Graded In	
Fabric Name	Pattern #
Ita	466693
North Island	466704
Lowell LUXE	466707
Cummings	466709
Byron	466710
Guise	466727
Knoll Velvet	466780
Doily	466807
Digi Velvet	466816
Dynamic	466845
Cato	466862
Limani	466906
Sandis	466915
Chic	466934

**NOTE:** Fabric with "\*" is Bleach Cleanable with diluted household bleach.

# GATEWAY™ TASK TABLES

## FEATURES & OPTIONS

### All Table Models:

#### Top Options:

#### Table Sizes:

- 24", 30", 36" D x 60", 66", 72", 78", 84", 90" L
- Standard top thickness is 1"

#### Top Shape:

- Rectangle with soft corner and Rectangle.

#### Edges:

- 2" Taper edge is standard for all depths of Fixed Height tables.
- 2" Taper edge is standard for all 30" & 36" deep Height Adjustable tables.
- \*Height Adjustable Tables 24" deep are only available with Self Edge.
- Both Fixed & Height adjustable available with Self Edge.

#### Material / Finishes:

- Gateway table tops and storage cases are available in all Nienkämper high quality veneers, stains and finishes.
- All standard plastic laminates are also available.



### FIXED HEIGHT TABLES

- **Fixed Leg Finishes:** Polished & all standard Nienkämper powder coat colors.
- **Foot Finishes:** Polished feet are standard but also can be painted to match column.
- **Foot Sizes:** 24" (table depths 24" & 30"), 34" (table depth 36")
- **Foot Options:** Leveler & Locking caster
- **Wire Management:** Through fixed post and base.

#### Fixed H Table Options:

- Higher capacity wire manager post.
- Ganging clips

### HEIGHT ADJUSTABLE TABLES

- **Height range:** 28½" - 54½" locking casters & 27" - 53" levelers
- **Leg Finishes:** 4 standard finishes are available (gray, black, white, chrome) custom colors not available
- **Foot Finishes:** Polished feet are standard but also can be painted to match column.
- **Foot Sizes:** 24" (table depths 24" & 30"), 34" (table depth 36")
- **Foot Options:** Leveler & Locking caster
- **H-Adj Power Supply:** Corded power is standard
- **Switches:** No display, under mount toggle is standard

#### Adjustable Height Table Options:

- Rechargeable table lift battery.
- Blue tooth enabled toggle switch
- Recessed flush mount switch.

#### Connectivity Options:

- **Desk Top Units:** Pop-up Forum, Simple Forum, rechargeable usb (4 port), Dean.
- **Under Desk Units:** 2 port low profile under surface power unit (available in 2 usb A or 1 usb A & 1 usb C), QuadTap 4 port power with coiled expandable cord.

#### Universal Accessories:

- High capacity Cable Conduit.
- Table mounted Divider Screens.
- Table top grommet.



Simple PopUp Forum



Simple Forum



Rechargeable USB



Dean



Low Profile USB



QuadTap

# GATEWAY™ TASK TABLES

## FIXED HEIGHT

### Rectangle Top on Levelers 29" Work Height:



Model Number	Table Dimensions	Top Finish	List Price
42455/2RL29	60"l x 24" w x 29"h	Veneer	4,245
<b>42455/5RL29</b>	<b>60"l x 24" w x 29"h</b>	<b>Laminate</b>	<b>3,620</b>
42456/2RL29	60"l x 30" w x 29"h	Veneer	5,305
<b>42456/5RL29</b>	<b>60"l x 30" w x 29"h</b>	<b>Laminate</b>	<b>4,515</b>
42457/2RL29	60"l x 36" w x 29"h	Veneer	6,355
<b>42457/5RL29</b>	<b>60"l x 36" w x 29"h</b>	<b>Laminate</b>	<b>5,415</b>
42458/2RL29	66"l x 24" w x 29"h	Veneer	4,670
<b>42458/5RL29</b>	<b>66"l x 24" w x 29"h</b>	<b>Laminate</b>	<b>3,970</b>
42459/2RL29	66"l x 30" w x 29"h	Veneer	5,825
<b>42459/5RL29</b>	<b>66"l x 30" w x 29"h</b>	<b>Laminate</b>	<b>4,965</b>
42460/2RL29	66"l x 36" w x 29"h	Veneer	6,995
<b>42460/5RL29</b>	<b>66"l x 36" w x 29"h</b>	<b>Laminate</b>	<b>5,955</b>
42461/2RL29	72"l x 24" w x 29"h	Veneer	5,090
<b>42461/5RL29</b>	<b>72"l x 24" w x 29"h</b>	<b>Laminate</b>	<b>4,340</b>
42462/2RL29	72"l x 30" w x 29"h	Veneer	6,355
<b>42462/5RL29</b>	<b>72"l x 30" w x 29"h</b>	<b>Laminate</b>	<b>5,415</b>
42463/2RL29	72"l x 36" w x 29"h	Veneer	7,625
<b>42463/5RL29</b>	<b>72"l x 36" w x 29"h</b>	<b>Laminate</b>	<b>6,500</b>
42464/2RL29	78"l x 24" w x 29"h	Veneer	5,510
<b>42464/5RL29</b>	<b>78"l x 24" w x 29"h</b>	<b>Laminate</b>	<b>4,695</b>
42465/2RL29	78"l x 30" w x 29"h	Veneer	6,885
<b>42465/5RL29</b>	<b>78"l x 30" w x 29"h</b>	<b>Laminate</b>	<b>5,870</b>
42466/2RL29	78"l x 36" w x 29"h	Veneer	8,255
<b>42466/5RL29</b>	<b>78"l x 36" w x 29"h</b>	<b>Laminate</b>	<b>7,030</b>
42467/2RL29	84"l x 24" w x 29"h	Veneer	5,935
<b>42467/5RL29</b>	<b>84"l x 24" w x 29"h</b>	<b>Laminate</b>	<b>5,060</b>
42468/2RL29	84"l x 30" w x 29"h	Veneer	7,410
<b>42468/5RL29</b>	<b>84"l x 30" w x 29"h</b>	<b>Laminate</b>	<b>6,320</b>
42469/2RL29	84"l x 36" w x 29"h	Veneer	8,895
<b>42469/5RL29</b>	<b>84"l x 36" w x 29"h</b>	<b>Laminate</b>	<b>7,585</b>
42470/2RL29	90"l x 24" w x 29"h	Veneer	6,355
<b>42470/5RL29</b>	<b>90"l x 24" w x 29"h</b>	<b>Laminate</b>	<b>5,415</b>
42471/2RL29	90"l x 30" w x 29"h	Veneer	7,950
<b>42471/5RL29</b>	<b>90"l x 30" w x 29"h</b>	<b>Laminate</b>	<b>6,770</b>
42472/2RL29	90"l x 36" w x 29"h	Veneer	9,530
<b>42472/5RL29</b>	<b>90"l x 36" w x 29"h</b>	<b>Laminate</b>	<b>8,120</b>

### Rectangle Top on Levelers 38" Standing Height:

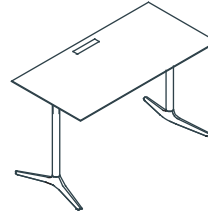

Model Number	Table Dimensions	Top Finish	List Price
42455/2RL38	60"l x 24" w x 38"h	Veneer	4,460
<b>42455/5RL38</b>	<b>60"l x 24" w x 38"h</b>	<b>Laminate</b>	<b>3,805</b>
42456/2RL38	60"l x 30" w x 38"h	Veneer	5,575
<b>42456/5RL38</b>	<b>60"l x 30" w x 38"h</b>	<b>Laminate</b>	<b>4,740</b>
42457/2RL38	60"l x 36" w x 38"h	Veneer	6,670
<b>42457/5RL38</b>	<b>60"l x 36" w x 38"h</b>	<b>Laminate</b>	<b>5,695</b>
42458/2RL38	66"l x 24" w x 38"h	Veneer	4,905
<b>42458/5RL38</b>	<b>66"l x 24" w x 38"h</b>	<b>Laminate</b>	<b>4,170</b>
42459/2RL38	66"l x 30" w x 38"h	Veneer	6,125
<b>42459/5RL38</b>	<b>66"l x 30" w x 38"h</b>	<b>Laminate</b>	<b>5,215</b>
42460/2RL38	66"l x 36" w x 38"h	Veneer	7,345
<b>42460/5RL38</b>	<b>66"l x 36" w x 38"h</b>	<b>Laminate</b>	<b>6,255</b>
42461/2RL38	72"l x 24" w x 38"h	Veneer	5,345
<b>42461/5RL38</b>	<b>72"l x 24" w x 38"h</b>	<b>Laminate</b>	<b>4,560</b>
42462/2RL38	72"l x 30" w x 38"h	Veneer	6,670
<b>42462/5RL38</b>	<b>72"l x 30" w x 38"h</b>	<b>Laminate</b>	<b>5,695</b>
42463/2RL38	72"l x 36" w x 38"h	Veneer	8,010
<b>42463/5RL38</b>	<b>72"l x 36" w x 38"h</b>	<b>Laminate</b>	<b>6,820</b>
42464/2RL38	78"l x 24" w x 38"h	Veneer	5,785
<b>42464/5RL38</b>	<b>78"l x 24" w x 38"h</b>	<b>Laminate</b>	<b>4,930</b>
42465/2RL38	78"l x 30" w x 38"h	Veneer	7,230
<b>42465/5RL38</b>	<b>78"l x 30" w x 38"h</b>	<b>Laminate</b>	<b>6,160</b>
42466/2RL38	78"l x 36" w x 38"h	Veneer	8,670
<b>42466/5RL38</b>	<b>78"l x 36" w x 38"h</b>	<b>Laminate</b>	<b>7,390</b>
42467/2RL38	84"l x 24" w x 38"h	Veneer	6,235
<b>42467/5RL38</b>	<b>84"l x 24" w x 38"h</b>	<b>Laminate</b>	<b>5,315</b>
42468/2RL38	84"l x 30" w x 38"h	Veneer	7,790
<b>42468/5RL38</b>	<b>84"l x 30" w x 38"h</b>	<b>Laminate</b>	<b>6,640</b>
42469/2RL38	84"l x 36" w x 38"h	Veneer	9,335
<b>42469/5RL38</b>	<b>84"l x 36" w x 38"h</b>	<b>Laminate</b>	<b>7,965</b>
42470/2RL38	90"l x 24" w x 38"h	Veneer	6,670
<b>42470/5RL38</b>	<b>90"l x 24" w x 38"h</b>	<b>Laminate</b>	<b>5,695</b>
42471/2RL38	90"l x 30" w x 38"h	Veneer	8,340
<b>42471/5RL38</b>	<b>90"l x 30" w x 38"h</b>	<b>Laminate</b>	<b>7,105</b>
42472/2RL38	90"l x 36" w x 38"h	Veneer	10,005
<b>42472/5RL38</b>	<b>90"l x 36" w x 38"h</b>	<b>Laminate</b>	<b>8,530</b>

Connectivity devices are to be ordered separately and cost is not reflected in above pricing.

# GATEWAY™ TASK TABLES

## FIXED HEIGHT

### Rectangle Top with Soft Corners - Levelers 29" Work Height:



### Rectangle Top with Soft Corners - Levelers 38" Standing Height:

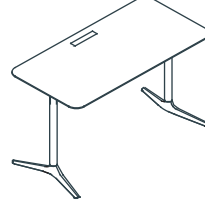

Model Number	Table Dimensions	Top Finish	List Price	Model Number	Table Dimensions	Top Finish	List Price
42455/2SL29	60"l x 24" w x 29"h	Veneer	4,350	42455/2SL38	60"l x 24" w x 38"h	Veneer	4,570
<b>42455/5SL29</b>	<b>60"l x 24" w x 29"h</b>	<b>Laminate</b>	<b>3,710</b>	<b>42455/5SL38</b>	<b>60"l x 24" w x 38"h</b>	<b>Laminate</b>	<b>3,900</b>
42456/2SL29	60"l x 30" w x 29"h	Veneer	5,440	42456/2SL38	60"l x 30" w x 38"h	Veneer	5,715
<b>42456/5SL29</b>	<b>60"l x 30" w x 29"h</b>	<b>Laminate</b>	<b>4,635</b>	<b>42456/5SL38</b>	<b>60"l x 30" w x 38"h</b>	<b>Laminate</b>	<b>4,865</b>
42457/2SL29	60"l x 36" w x 29"h	Veneer	6,525	42457/2SL38	60"l x 36" w x 38"h	Veneer	6,850
<b>42457/5SL29</b>	<b>60"l x 36" w x 29"h</b>	<b>Laminate</b>	<b>5,550</b>	<b>42457/5SL38</b>	<b>60"l x 36" w x 38"h</b>	<b>Laminate</b>	<b>5,830</b>
42458/2SL29	66"l x 24" w x 29"h	Veneer	4,785	42458/2SL38	66"l x 24" w x 38"h	Veneer	5,030
<b>42458/5SL29</b>	<b>66"l x 24" w x 29"h</b>	<b>Laminate</b>	<b>4,075</b>	<b>42458/5SL38</b>	<b>66"l x 24" w x 38"h</b>	<b>Laminate</b>	<b>4,280</b>
42459/2SL29	66"l x 30" w x 29"h	Veneer	5,980	42459/2SL38	66"l x 30" w x 38"h	Veneer	6,280
<b>42459/5SL29</b>	<b>66"l x 30" w x 29"h</b>	<b>Laminate</b>	<b>5,095</b>	<b>42459/5SL38</b>	<b>66"l x 30" w x 38"h</b>	<b>Laminate</b>	<b>5,350</b>
42460/2SL29	66"l x 36" w x 29"h	Veneer	7,165	42460/2SL38	66"l x 36" w x 38"h	Veneer	7,530
<b>42460/5SL29</b>	<b>66"l x 36" w x 29"h</b>	<b>Laminate</b>	<b>6,115</b>	<b>42460/5SL38</b>	<b>66"l x 36" w x 38"h</b>	<b>Laminate</b>	<b>6,420</b>
42461/2SL29	72"l x 24" w x 29"h	Veneer	5,215	42461/2SL38	72"l x 24" w x 38"h	Veneer	5,490
<b>42461/5SL29</b>	<b>72"l x 24" w x 29"h</b>	<b>Laminate</b>	<b>4,455</b>	<b>42461/5SL38</b>	<b>72"l x 24" w x 38"h</b>	<b>Laminate</b>	<b>4,680</b>
42462/2SL29	72"l x 30" w x 29"h	Veneer	6,525	42462/2SL38	72"l x 30" w x 38"h	Veneer	6,850
<b>42462/5SL29</b>	<b>72"l x 30" w x 29"h</b>	<b>Laminate</b>	<b>5,550</b>	<b>42462/5SL38</b>	<b>72"l x 30" w x 38"h</b>	<b>Laminate</b>	<b>5,830</b>
42463/2SL29	72"l x 36" w x 29"h	Veneer	7,820	42463/2SL38	72"l x 36" w x 38"h	Veneer	8,215
<b>42463/5SL29</b>	<b>72"l x 36" w x 29"h</b>	<b>Laminate</b>	<b>6,660</b>	<b>42463/5SL38</b>	<b>72"l x 36" w x 38"h</b>	<b>Laminate</b>	<b>7,000</b>
42464/2SL29	78"l x 24" w x 29"h	Veneer	5,645	42464/2SL38	78"l x 24" w x 38"h	Veneer	5,930
<b>42464/5SL29</b>	<b>78"l x 24" w x 29"h</b>	<b>Laminate</b>	<b>4,815</b>	<b>42464/5SL38</b>	<b>78"l x 24" w x 38"h</b>	<b>Laminate</b>	<b>5,060</b>
42465/2SL29	78"l x 30" w x 29"h	Veneer	7,055	42465/2SL38	78"l x 30" w x 38"h	Veneer	7,415
<b>42465/5SL29</b>	<b>78"l x 30" w x 29"h</b>	<b>Laminate</b>	<b>6,015</b>	<b>42465/5SL38</b>	<b>78"l x 30" w x 38"h</b>	<b>Laminate</b>	<b>6,320</b>
42466/2SL29	78"l x 36" w x 29"h	Veneer	8,465	42466/2SL38	78"l x 36" w x 38"h	Veneer	8,890
<b>42466/5SL29</b>	<b>78"l x 36" w x 29"h</b>	<b>Laminate</b>	<b>7,220</b>	<b>42466/5SL38</b>	<b>78"l x 36" w x 38"h</b>	<b>Laminate</b>	<b>7,585</b>
42467/2SL29	84"l x 24" w x 29"h	Veneer	6,085	42467/2SL38	84"l x 24" w x 38"h	Veneer	6,390
<b>42467/5SL29</b>	<b>84"l x 24" w x 29"h</b>	<b>Laminate</b>	<b>5,185</b>	<b>42467/5SL38</b>	<b>84"l x 24" w x 38"h</b>	<b>Laminate</b>	<b>5,455</b>
42468/2SL29	84"l x 30" w x 29"h	Veneer	7,600	42468/2SL38	84"l x 30" w x 38"h	Veneer	7,980
<b>42468/5SL29</b>	<b>84"l x 30" w x 29"h</b>	<b>Laminate</b>	<b>6,475</b>	<b>42468/5SL38</b>	<b>84"l x 30" w x 38"h</b>	<b>Laminate</b>	<b>6,800</b>
42469/2SL29	84"l x 36" w x 29"h	Veneer	9,115	42469/2SL38	84"l x 36" w x 38"h	Veneer	9,575
<b>42469/5SL29</b>	<b>84"l x 36" w x 29"h</b>	<b>Laminate</b>	<b>7,780</b>	<b>42469/5SL38</b>	<b>84"l x 36" w x 38"h</b>	<b>Laminate</b>	<b>8,170</b>
42470/2SL29	90"l x 24" w x 29"h	Veneer	6,525	42470/2SL38	90"l x 24" w x 38"h	Veneer	6,850
<b>42470/5SL29</b>	<b>90"l x 24" w x 29"h</b>	<b>Laminate</b>	<b>5,550</b>	<b>42470/5SL38</b>	<b>90"l x 24" w x 38"h</b>	<b>Laminate</b>	<b>5,830</b>
42471/2SL29	90"l x 30" w x 29"h	Veneer	8,140	42471/2SL38	90"l x 30" w x 38"h	Veneer	8,550
<b>42471/5SL29</b>	<b>90"l x 30" w x 29"h</b>	<b>Laminate</b>	<b>6,930</b>	<b>42471/5SL38</b>	<b>90"l x 30" w x 38"h</b>	<b>Laminate</b>	<b>7,280</b>
42472/2SL29	90"l x 36" w x 29"h	Veneer	9,765	42472/2SL38	90"l x 36" w x 38"h	Veneer	10,255
<b>42472/5SL29</b>	<b>90"l x 36" w x 29"h</b>	<b>Laminate</b>	<b>8,325</b>	<b>42472/5SL38</b>	<b>90"l x 36" w x 38"h</b>	<b>Laminate</b>	<b>8,745</b>

Connectivity devices are to be ordered separately and cost is not reflected in above pricing.

# GATEWAY™ TASK TABLES

## FIXED HEIGHT

### Rectangle Top - Casters 29" Work Height:

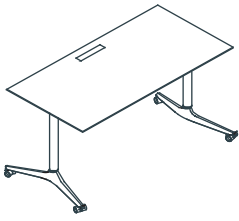

Model Number	Table Dimensions	Top Finish	List Price
42473/2RC29	60"l x 24" w x 29"h	Veneer	4,450
<b>42455/5RC29</b>	<b>60"l x 24" w x 29"h</b>	<b>Laminate</b>	<b>3,820</b>
42474/2RC29	60"l x 30" w x 29"h	Veneer	5,505
<b>42474/5RC29</b>	<b>60"l x 30" w x 29"h</b>	<b>Laminate</b>	<b>4,715</b>
42475/2RC29	60"l x 36" w x 29"h	Veneer	6,555
<b>42475/5RC29</b>	<b>60"l x 36" w x 29"h</b>	<b>Laminate</b>	<b>5,615</b>
42476/2RC29	66"l x 24" w x 29"h	Veneer	4,865
<b>42476/5RC29</b>	<b>66"l x 24" w x 29"h</b>	<b>Laminate</b>	<b>4,170</b>
42477/2RC29	66"l x 30" w x 29"h	Veneer	6,025
<b>42477/5RC29</b>	<b>66"l x 30" w x 29"h</b>	<b>Laminate</b>	<b>5,170</b>
42478/2RC29	66"l x 36" w x 29"h	Veneer	7,200
<b>42478/5RC29</b>	<b>66"l x 36" w x 29"h</b>	<b>Laminate</b>	<b>6,160</b>
42479/2RC29	72"l x 24" w x 29"h	Veneer	5,290
<b>42479/5RC29</b>	<b>72"l x 24" w x 29"h</b>	<b>Laminate</b>	<b>4,545</b>
42480/2RC29	72"l x 30" w x 29"h	Veneer	6,555
<b>42480/5RC29</b>	<b>72"l x 30" w x 29"h</b>	<b>Laminate</b>	<b>5,615</b>
42481/2RC29	72"l x 36" w x 29"h	Veneer	7,825
<b>42481/5RC29</b>	<b>72"l x 36" w x 29"h</b>	<b>Laminate</b>	<b>6,700</b>
42482/2RC29	78"l x 24" w x 29"h	Veneer	5,710
<b>42482/5RC29</b>	<b>78"l x 24" w x 29"h</b>	<b>Laminate</b>	<b>4,900</b>
42483/2RC29	78"l x 30" w x 29"h	Veneer	7,090
<b>42483/5RC29</b>	<b>78"l x 30" w x 29"h</b>	<b>Laminate</b>	<b>6,065</b>
42484/2RC29	78"l x 36" w x 29"h	Veneer	8,455
<b>42484/5RC29</b>	<b>78"l x 36" w x 29"h</b>	<b>Laminate</b>	<b>7,235</b>
42485/2RC29	84"l x 24" w x 29"h	Veneer	6,135
<b>42485/5RC29</b>	<b>84"l x 24" w x 29"h</b>	<b>Laminate</b>	<b>5,265</b>
42486/2RC29	84"l x 30" w x 29"h	Veneer	7,610
<b>42486/5RC29</b>	<b>84"l x 30" w x 29"h</b>	<b>Laminate</b>	<b>6,525</b>
42487/2RC29	84"l x 36" w x 29"h	Veneer	9,095
<b>42487/5RC29</b>	<b>84"l x 36" w x 29"h</b>	<b>Laminate</b>	<b>7,785</b>
42488/2RC29	90"l x 24" w x 29"h	Veneer	6,555
<b>42488/5RC29</b>	<b>90"l x 24" w x 29"h</b>	<b>Laminate</b>	<b>5,615</b>
42489/2RC29	90"l x 30" w x 29"h	Veneer	8,140
<b>42489/5RC29</b>	<b>90"l x 30" w x 29"h</b>	<b>Laminate</b>	<b>6,975</b>
42490/2RC29	90"l x 36" w x 29"h	Veneer	9,725
<b>42490/5RC29</b>	<b>90"l x 36" w x 29"h</b>	<b>Laminate</b>	<b>8,320</b>

### Rectangle Top with Soft Corners - Casters 29" Work Height:



Model Number	Table Dimensions	Top Finish	List Price
42473/2SC29	60"l x 24" w x 29"h	Veneer	4,555
<b>42473/5SC29</b>	<b>60"l x 24" w x 29"h</b>	<b>Laminate</b>	<b>3,915</b>
42474/2SC29	60"l x 30" w x 29"h	Veneer	5,640
<b>42474/5SC29</b>	<b>60"l x 30" w x 29"h</b>	<b>Laminate</b>	<b>4,830</b>
42475/2SC29	60"l x 36" w x 29"h	Veneer	6,715
<b>42475/5SC29</b>	<b>60"l x 36" w x 29"h</b>	<b>Laminate</b>	<b>5,755</b>
42476/2SC29	66"l x 24" w x 29"h	Veneer	4,980
<b>42476/5SC29</b>	<b>66"l x 24" w x 29"h</b>	<b>Laminate</b>	<b>4,275</b>
42477/2SC29	66"l x 30" w x 29"h	Veneer	6,175
<b>42477/5SC29</b>	<b>66"l x 30" w x 29"h</b>	<b>Laminate</b>	<b>5,295</b>
42478/2SC29	66"l x 36" w x 29"h	Veneer	7,370
<b>42478/5SC29</b>	<b>66"l x 36" w x 29"h</b>	<b>Laminate</b>	<b>6,315</b>
42479/2SC29	72"l x 24" w x 29"h	Veneer	5,420
<b>42479/5SC29</b>	<b>72"l x 24" w x 29"h</b>	<b>Laminate</b>	<b>4,660</b>
42480/2SC29	72"l x 30" w x 29"h	Veneer	6,715
<b>42480/5SC29</b>	<b>72"l x 30" w x 29"h</b>	<b>Laminate</b>	<b>5,755</b>
42481/2SC29	72"l x 36" w x 29"h	Veneer	8,020
<b>42481/5SC29</b>	<b>72"l x 36" w x 29"h</b>	<b>Laminate</b>	<b>6,865</b>
42482/2SC29	78"l x 24" w x 29"h	Veneer	5,840
<b>42482/5SC29</b>	<b>78"l x 24" w x 29"h</b>	<b>Laminate</b>	<b>5,015</b>
42483/2SC29	78"l x 30" w x 29"h	Veneer	7,260
<b>42483/5SC29</b>	<b>78"l x 30" w x 29"h</b>	<b>Laminate</b>	<b>6,220</b>
42484/2SC29	78"l x 36" w x 29"h	Veneer	8,665
<b>42484/5SC29</b>	<b>78"l x 36" w x 29"h</b>	<b>Laminate</b>	<b>7,415</b>
42485/2SC29	84"l x 24" w x 29"h	Veneer	6,285
<b>42485/5SC29</b>	<b>84"l x 24" w x 29"h</b>	<b>Laminate</b>	<b>5,390</b>
42486/2SC29	84"l x 30" w x 29"h	Veneer	7,805
<b>42486/5SC29</b>	<b>84"l x 30" w x 29"h</b>	<b>Laminate</b>	<b>6,675</b>
42487/2SC29	84"l x 36" w x 29"h	Veneer	9,320
<b>42487/5SC29</b>	<b>84"l x 36" w x 29"h</b>	<b>Laminate</b>	<b>7,975</b>
42488/2SC29	90"l x 24" w x 29"h	Veneer	6,715
<b>42488/5SC29</b>	<b>90"l x 24" w x 29"h</b>	<b>Laminate</b>	<b>5,755</b>
42489/2SC29	90"l x 30" w x 29"h	Veneer	8,340
<b>42489/5SC29</b>	<b>90"l x 30" w x 29"h</b>	<b>Laminate</b>	<b>7,135</b>
42490/2SC29	90"l x 36" w x 29"h	Veneer	9,960
<b>42490/5SC29</b>	<b>90"l x 36" w x 29"h</b>	<b>Laminate</b>	<b>8,530</b>

Connectivity devices are to be ordered separately and cost is not reflected in above pricing.

# GATEWAY™ TASK TABLES

## HEIGHT ADJUSTABLE

### Rectangle Top - Levelers 27" - 53" Work Height:

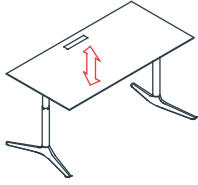

Model Number	Table Dimensions	Top Finish	List Price
42455/2RLA	60"l x 24" w x 27"-53"h	Veneer	6,755
<b>42455/5RLA</b>	<b>60"l x 24" w x 27"-53"h</b>	<b>Laminate</b>	<b>6,125</b>
42456/2RLA	60"l x 30" w x 27"-53"h	Veneer	7,810
<b>42456/5RLA</b>	<b>60"l x 30" w x 27"-53"h</b>	<b>Laminate</b>	<b>7,020</b>
42457/2RLA	60"l x 36" w x 27"-53"h	Veneer	8,860
<b>42457/5RLA</b>	<b>60"l x 36" w x 27"-53"h</b>	<b>Laminate</b>	<b>7,920</b>
42458/2RLA	66"l x 24" w x 27"-53"h	Veneer	7,165
<b>42458/5RLA</b>	<b>66"l x 24" w x 27"-53"h</b>	<b>Laminate</b>	<b>6,475</b>
42459/2RLA	66"l x 30" w x 27"-53"h	Veneer	8,330
<b>42459/5RLA</b>	<b>66"l x 30" w x 27"-53"h</b>	<b>Laminate</b>	<b>7,475</b>
42460/2RLA	66"l x 36" w x 27"-53"h	Veneer	9,500
<b>42460/5RLA</b>	<b>66"l x 36" w x 27"-53"h</b>	<b>Laminate</b>	<b>8,465</b>
42461/2RLA	72"l x 24" w x 27"-53"h	Veneer	7,595
<b>42461/5RLA</b>	<b>72"l x 24" w x 27"-53"h</b>	<b>Laminate</b>	<b>6,850</b>
42462/2RLA	72"l x 30" w x 27"-53"h	Veneer	8,860
<b>42462/5RLA</b>	<b>72"l x 30" w x 27"-53"h</b>	<b>Laminate</b>	<b>7,920</b>
42463/2RLA	72"l x 36" w x 27"-53"h	Veneer	10,130
<b>42463/5RLA</b>	<b>72"l x 36" w x 27"-53"h</b>	<b>Laminate</b>	<b>9,000</b>
42464/2RLA	78"l x 24" w x 27"-53"h	Veneer	8,015
<b>42464/5RLA</b>	<b>78"l x 24" w x 27"-53"h</b>	<b>Laminate</b>	<b>7,205</b>
42465/2RLA	78"l x 30" w x 27"-53"h	Veneer	9,395
<b>42465/5RLA</b>	<b>78"l x 30" w x 27"-53"h</b>	<b>Laminate</b>	<b>8,370</b>
42466/2RLA	78"l x 36" w x 27"-53"h	Veneer	10,760
<b>42466/5RLA</b>	<b>78"l x 36" w x 27"-53"h</b>	<b>Laminate</b>	<b>9,540</b>
42467/2RLA	84"l x 24" w x 27"-53"h	Veneer	8,440
<b>42467/5RLA</b>	<b>84"l x 24" w x 27"-53"h</b>	<b>Laminate</b>	<b>7,570</b>
42468/2RLA	84"l x 30" w x 27"-53"h	Veneer	9,915
<b>42468/5RLA</b>	<b>84"l x 30" w x 27"-53"h</b>	<b>Laminate</b>	<b>8,820</b>
42469/2RLA	84"l x 36" w x 27"-53"h	Veneer	11,400
<b>42469/5RLA</b>	<b>84"l x 36" w x 27"-53"h</b>	<b>Laminate</b>	<b>10,090</b>
42470/2RLA	90"l x 24" w x 27"-53"h	Veneer	8,860
<b>42470/5RLA</b>	<b>90"l x 24" w x 27"-53"h</b>	<b>Laminate</b>	<b>7,920</b>
42471/2RLA	90"l x 30" w x 27"-53"h	Veneer	10,450
<b>42471/5RLA</b>	<b>90"l x 30" w x 27"-53"h</b>	<b>Laminate</b>	<b>9,280</b>
42472/2RLA	90"l x 36" w x 27"-53"h	Veneer	12,030
<b>42472/5RLA</b>	<b>90"l x 36" w x 27"-53"h</b>	<b>Laminate</b>	<b>10,625</b>

### Rectangle Top with Soft Corners - Levelers 27" - 53" Work Height:

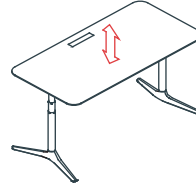

Model Number	Table Dimensions	Top Finish	List Price
42455/2SLA	60"l x 24" w x 27"-53"h	Veneer	6,860
<b>42455/5SLA</b>	<b>60"l x 24" w x 27"-53"h</b>	<b>Laminate</b>	<b>6,220</b>
42456/2SLA	60"l x 30" w x 27"-53"h	Veneer	7,950
<b>42456/5SLA</b>	<b>60"l x 30" w x 27"-53"h</b>	<b>Laminate</b>	<b>7,135</b>
42457/2SLA	60"l x 36" w x 27"-53"h	Veneer	9,020
<b>42457/5SLA</b>	<b>60"l x 36" w x 27"-53"h</b>	<b>Laminate</b>	<b>8,060</b>
42458/2SLA	66"l x 24" w x 27"-53"h	Veneer	7,280
<b>42458/5SLA</b>	<b>66"l x 24" w x 27"-53"h</b>	<b>Laminate</b>	<b>6,580</b>
42459/2SLA	66"l x 30" w x 27"-53"h	Veneer	8,480
<b>42459/5SLA</b>	<b>66"l x 30" w x 27"-53"h</b>	<b>Laminate</b>	<b>7,600</b>
42460/2SLA	66"l x 36" w x 27"-53"h	Veneer	9,675
<b>42460/5SLA</b>	<b>66"l x 36" w x 27"-53"h</b>	<b>Laminate</b>	<b>8,620</b>
42461/2SLA	72"l x 24" w x 27"-53"h	Veneer	7,720
<b>42461/5SLA</b>	<b>72"l x 24" w x 27"-53"h</b>	<b>Laminate</b>	<b>6,965</b>
42462/2SLA	72"l x 30" w x 27"-53"h	Veneer	9,020
<b>42462/5SLA</b>	<b>72"l x 30" w x 27"-53"h</b>	<b>Laminate</b>	<b>8,060</b>
42463/2SLA	72"l x 36" w x 27"-53"h	Veneer	10,325
<b>42463/5SLA</b>	<b>72"l x 36" w x 27"-53"h</b>	<b>Laminate</b>	<b>9,170</b>
42464/2SLA	78"l x 24" w x 27"-53"h	Veneer	8,145
<b>42464/5SLA</b>	<b>78"l x 24" w x 27"-53"h</b>	<b>Laminate</b>	<b>7,325</b>
42465/2SLA	78"l x 30" w x 27"-53"h	Veneer	9,565
<b>42465/5SLA</b>	<b>78"l x 30" w x 27"-53"h</b>	<b>Laminate</b>	<b>8,520</b>
42466/2SLA	78"l x 36" w x 27"-53"h	Veneer	10,970
<b>42466/5SLA</b>	<b>78"l x 36" w x 27"-53"h</b>	<b>Laminate</b>	<b>9,720</b>
42467/2SLA	84"l x 24" w x 27"-53"h	Veneer	8,590
<b>42467/5SLA</b>	<b>84"l x 24" w x 27"-53"h</b>	<b>Laminate</b>	<b>7,695</b>
42468/2SLA	84"l x 30" w x 27"-53"h	Veneer	10,110
<b>42468/5SLA</b>	<b>84"l x 30" w x 27"-53"h</b>	<b>Laminate</b>	<b>8,980</b>
42469/2SLA	84"l x 36" w x 27"-53"h	Veneer	11,625
<b>42469/5SLA</b>	<b>84"l x 36" w x 27"-53"h</b>	<b>Laminate</b>	<b>10,280</b>
42470/2SLA	90"l x 24" w x 27"-53"h	Veneer	9,020
<b>42470/5SLA</b>	<b>90"l x 24" w x 27"-53"h</b>	<b>Laminate</b>	<b>8,060</b>
42471/2SLA	90"l x 30" w x 27"-53"h	Veneer	10,645
<b>42471/5SLA</b>	<b>90"l x 30" w x 27"-53"h</b>	<b>Laminate</b>	<b>9,440</b>
42472/2SLA	90"l x 36" w x 27"-53"h	Veneer	12,265
<b>42472/5SLA</b>	<b>90"l x 36" w x 27"-53"h</b>	<b>Laminate</b>	<b>10,830</b>

Connectivity devices are to be ordered separately and cost is not reflected in above pricing.

# GATEWAY™ TASK TABLES

## HEIGHT ADJUSTABLE

### Rectangle Top - Casters 28½" - 54½" Work Height:

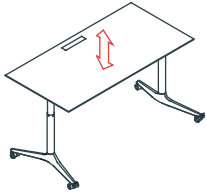

Model Number	Table Dimensions	Top Finish	List Price
42473/2RCA	60"l x 24" w x 28½"-54½"h	Veneer	6,950
<b>42473/5RCA</b>	<b>60"l x 24" w x 28½"-54½"h</b>	<b>Laminate</b>	<b>6,325</b>
42474/2RCA	60"l x 30" w x 28½"-54½"h	Veneer	8,010
<b>42474/5RCA</b>	<b>60"l x 30" w x 28½"-54½"h</b>	<b>Laminate</b>	<b>7,225</b>
42475/2RCA	60"l x 36" w x 28½"-54½"h	Veneer	9,065
<b>42475/5RCA</b>	<b>60"l x 36" w x 28½"-54½"h</b>	<b>Laminate</b>	<b>8,120</b>
42476/2RCA	66"l x 24" w x 28½"-54½"h	Veneer	7,370
<b>42476/5RCA</b>	<b>66"l x 24" w x 28½"-54½"h</b>	<b>Laminate</b>	<b>6,675</b>
42477/2RCA	66"l x 30" w x 28½"-54½"h	Veneer	8,535
<b>42477/5RCA</b>	<b>66"l x 30" w x 28½"-54½"h</b>	<b>Laminate</b>	<b>7,680</b>
42478/2RCA	66"l x 36" w x 28½"-54½"h	Veneer	9,695
<b>42478/5RCA</b>	<b>66"l x 36" w x 28½"-54½"h</b>	<b>Laminate</b>	<b>8,665</b>
42479/2RCA	72"l x 24" w x 28½"-54½"h	Veneer	7,800
<b>42479/5RCA</b>	<b>72"l x 24" w x 28½"-54½"h</b>	<b>Laminate</b>	<b>7,035</b>
42480/2RCA	72"l x 30" w x 28½"-54½"h	Veneer	9,065
<b>42480/5RCA</b>	<b>72"l x 30" w x 28½"-54½"h</b>	<b>Laminate</b>	<b>8,120</b>
42481/2RCA	72"l x 36" w x 28½"-54½"h	Veneer	10,330
<b>42481/5RCA</b>	<b>72"l x 36" w x 28½"-54½"h</b>	<b>Laminate</b>	<b>9,205</b>
42482/2RCA	78"l x 24" w x 28½"-54½"h	Veneer	8,215
<b>42482/5RCA</b>	<b>78"l x 24" w x 28½"-54½"h</b>	<b>Laminate</b>	<b>7,400</b>
42483/2RCA	78"l x 30" w x 28½"-54½"h	Veneer	9,585
<b>42483/5RCA</b>	<b>78"l x 30" w x 28½"-54½"h</b>	<b>Laminate</b>	<b>8,570</b>
42484/2RCA	78"l x 36" w x 28½"-54½"h	Veneer	10,965
<b>42484/5RCA</b>	<b>78"l x 36" w x 28½"-54½"h</b>	<b>Laminate</b>	<b>9,745</b>
42485/2RCA	84"l x 24" w x 28½"-54½"h	Veneer	8,640
<b>42485/5RCA</b>	<b>84"l x 24" w x 28½"-54½"h</b>	<b>Laminate</b>	<b>7,760</b>
42486/2RCA	84"l x 30" w x 28½"-54½"h	Veneer	10,120
<b>42486/5RCA</b>	<b>84"l x 30" w x 28½"-54½"h</b>	<b>Laminate</b>	<b>9,020</b>
42487/2RCA	84"l x 36" w x 28½"-54½"h	Veneer	11,605
<b>42487/5RCA</b>	<b>84"l x 36" w x 28½"-54½"h</b>	<b>Laminate</b>	<b>10,285</b>
42488/2RCA	90"l x 24" w x 28½"-54½"h	Veneer	9,065
<b>42488/5RCA</b>	<b>90"l x 24" w x 28½"-54½"h</b>	<b>Laminate</b>	<b>8,120</b>
42489/2RCA	90"l x 30" w x 28½"-54½"h	Veneer	10,645
<b>42489/5RCA</b>	<b>90"l x 30" w x 28½"-54½"h</b>	<b>Laminate</b>	<b>9,470</b>
42490/2RCA	90"l x 36" w x 28½"-54½"h	Veneer	12,230
<b>42490/5RCA</b>	<b>90"l x 36" w x 28½"-54½"h</b>	<b>Laminate</b>	<b>10,825</b>

### Rectangle Top with Soft Corners - Casters 28½" - 54½" Work Height:

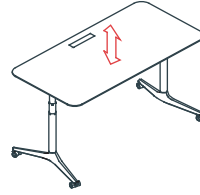

Model Number	Table Dimensions	Top Finish	List Price
42473/2SCA	60"l x 24" w x 28½"-54½"h	Veneer	7,050
<b>42473/5SCA</b>	<b>60"l x 24" w x 28½"-54½"h</b>	<b>Laminate</b>	<b>6,420</b>
42474/2SCA	60"l x 30" w x 28½"-54½"h	Veneer	8,140
<b>42474/5SCA</b>	<b>60"l x 30" w x 28½"-54½"h</b>	<b>Laminate</b>	<b>7,340</b>
42475/2SCA	60"l x 36" w x 28½"-54½"h	Veneer	9,220
<b>42475/5SCA</b>	<b>60"l x 36" w x 28½"-54½"h</b>	<b>Laminate</b>	<b>8,255</b>
42476/2SCA	66"l x 24" w x 28½"-54½"h	Veneer	7,485
<b>42476/5SCA</b>	<b>66"l x 24" w x 28½"-54½"h</b>	<b>Laminate</b>	<b>6,780</b>
42477/2SCA	66"l x 30" w x 28½"-54½"h	Veneer	8,680
<b>42477/5SCA</b>	<b>66"l x 30" w x 28½"-54½"h</b>	<b>Laminate</b>	<b>7,805</b>
42478/2SCA	66"l x 36" w x 28½"-54½"h	Veneer	9,880
<b>42478/5SCA</b>	<b>66"l x 36" w x 28½"-54½"h</b>	<b>Laminate</b>	<b>8,815</b>
42479/2SCA	72"l x 24" w x 28½"-54½"h	Veneer	7,925
<b>42479/5SCA</b>	<b>72"l x 24" w x 28½"-54½"h</b>	<b>Laminate</b>	<b>7,155</b>
42480/2SCA	72"l x 30" w x 28½"-54½"h	Veneer	9,220
<b>42480/5SCA</b>	<b>72"l x 30" w x 28½"-54½"h</b>	<b>Laminate</b>	<b>8,255</b>
42481/2SCA	72"l x 36" w x 28½"-54½"h	Veneer	10,525
<b>42481/5SCA</b>	<b>72"l x 36" w x 28½"-54½"h</b>	<b>Laminate</b>	<b>9,360</b>
42482/2SCA	78"l x 24" w x 28½"-54½"h	Veneer	8,350
<b>42482/5SCA</b>	<b>78"l x 24" w x 28½"-54½"h</b>	<b>Laminate</b>	<b>7,515</b>
42483/2SCA	78"l x 30" w x 28½"-54½"h	Veneer	9,765
<b>42483/5SCA</b>	<b>78"l x 30" w x 28½"-54½"h</b>	<b>Laminate</b>	<b>8,725</b>
42484/2SCA	78"l x 36" w x 28½"-54½"h	Veneer	11,170
<b>42484/5SCA</b>	<b>78"l x 36" w x 28½"-54½"h</b>	<b>Laminate</b>	<b>9,920</b>
42485/2SCA	84"l x 24" w x 28½"-54½"h	Veneer	8,790
<b>42485/5SCA</b>	<b>84"l x 24" w x 28½"-54½"h</b>	<b>Laminate</b>	<b>7,895</b>
42486/2SCA	84"l x 30" w x 28½"-54½"h	Veneer	10,305
<b>42486/5SCA</b>	<b>84"l x 30" w x 28½"-54½"h</b>	<b>Laminate</b>	<b>9,185</b>
42487/2SCA	84"l x 36" w x 28½"-54½"h	Veneer	11,830
<b>42487/5SCA</b>	<b>84"l x 36" w x 28½"-54½"h</b>	<b>Laminate</b>	<b>10,485</b>
42488/2SCA	90"l x 24" w x 28½"-54½"h	Veneer	9,220
<b>42488/5SCA</b>	<b>90"l x 24" w x 28½"-54½"h</b>	<b>Laminate</b>	<b>8,255</b>
42489/2SCA	90"l x 30" w x 28½"-54½"h	Veneer	10,850
<b>42489/5SCA</b>	<b>90"l x 30" w x 28½"-54½"h</b>	<b>Laminate</b>	<b>9,645</b>
42490/2SCA	90"l x 36" w x 28½"-54½"h	Veneer	12,470
<b>42490/5SCA</b>	<b>90"l x 36" w x 28½"-54½"h</b>	<b>Laminate</b>	<b>11,025</b>

Connectivity devices are to be ordered separately and cost is not reflected in above pricing.

# GATEWAY™ PRIVACY DIVIDER PANELS

## FEATURES & OPTIONS

— CND ONLY —

### Dimensions:

- Dividers are available in 6 lengths x 24”h x 1<sup>5</sup>/<sub>16</sub>” thick with a 1” radius in each corner.

### Construction:

- Hollow core panel with both tackable and non-tackable finished surface.
- Dividers are mounted to the underside of the table top with steel brackets. These brackets have a series of slotted holes that allow the end user to loosen and create a <sup>3</sup>/<sub>8</sub>” gap between panel and table for wire passage.

### Fabric:

- Any KnollTextiles fabric is acceptable for divider panels however keep in mind that excessive use as tack board may result in premature wear. Speak with customer service to select the fabric that is right for your application.
- COM fabric is acceptable to use but must be approved by Nienkämper.
- Gateway “Y” seam is standard to both front and rear of dividers.

### Options:

- A plastic wire management trough can be added.



Model Number	Divider Dimensions	Fabric Yrd	List Price	
			COM	KnollTextiles 1
42491	52”l x 1 <sup>5</sup> / <sub>16</sub> ”w x 24”h	2	920	1,215
<b>42492</b>	<b>58”l x 1<sup>5</sup>/<sub>16</sub>”w x 24”h</b>	<b>2 ½</b>	<b>1,010</b>	<b>1,380</b>
42493	64”l x 1 <sup>5</sup> / <sub>16</sub> ”w x 24”h	2½	1,095	1,460
<b>42494</b>	<b>70”l x 1<sup>5</sup>/<sub>16</sub>”w x 24”h</b>	<b>3</b>	<b>1,185</b>	<b>1,625</b>
42495	76”l x 1 <sup>5</sup> / <sub>16</sub> ”w x 24”h	3	1,275	1,715
<b>42496</b>	<b>82”l x 1<sup>5</sup>/<sub>16</sub>”w x 24”h</b>	<b>3</b>	<b>1,360</b>	<b>1,805</b>
42497	88”l x 1 <sup>5</sup> / <sub>16</sub> ”w x 24”h	4	1,445	2,035

### Upholstered Divider Panels:

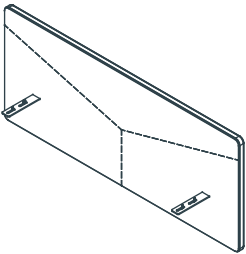

Yardage calculated based on 54” roll width and includes both sides of panel.  
Fabric can be different on each side.

**GATEWAY™ PRIVACY DIVIDER PANELS**  
**PRIVACY DIVIDER PANEL SIZE SPECIFICATION**

**Typical Divider Fit with Rectangle Top**

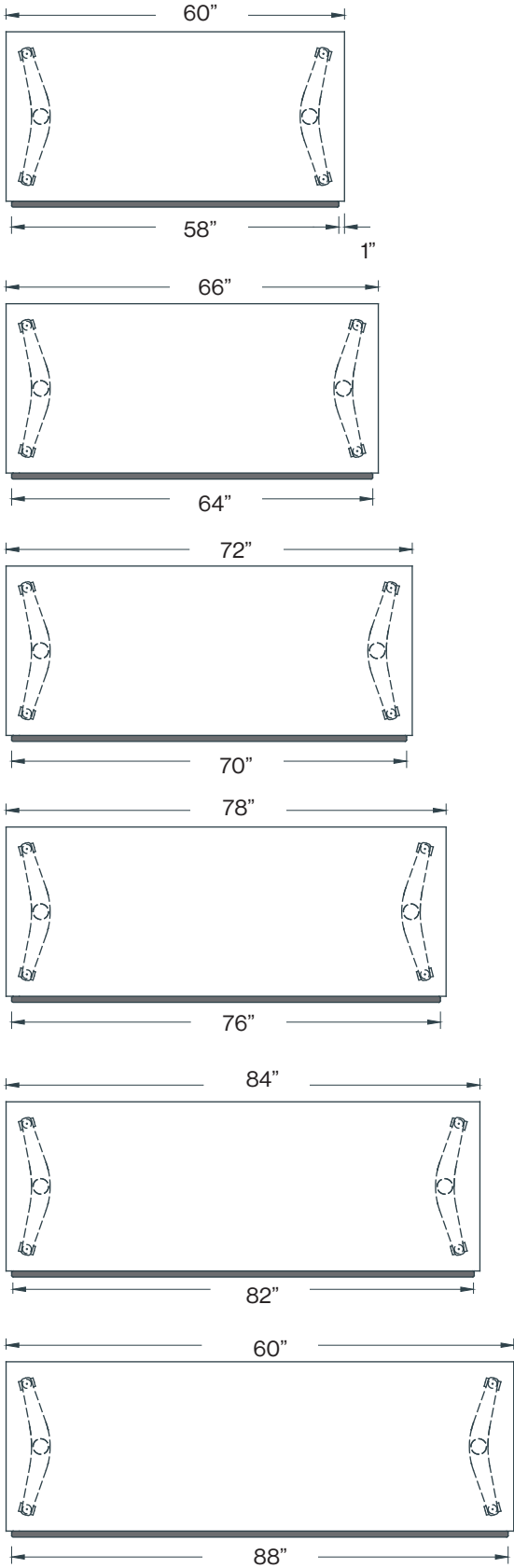

**Typical Divider Fit with Soft Corners Rectangle Top**

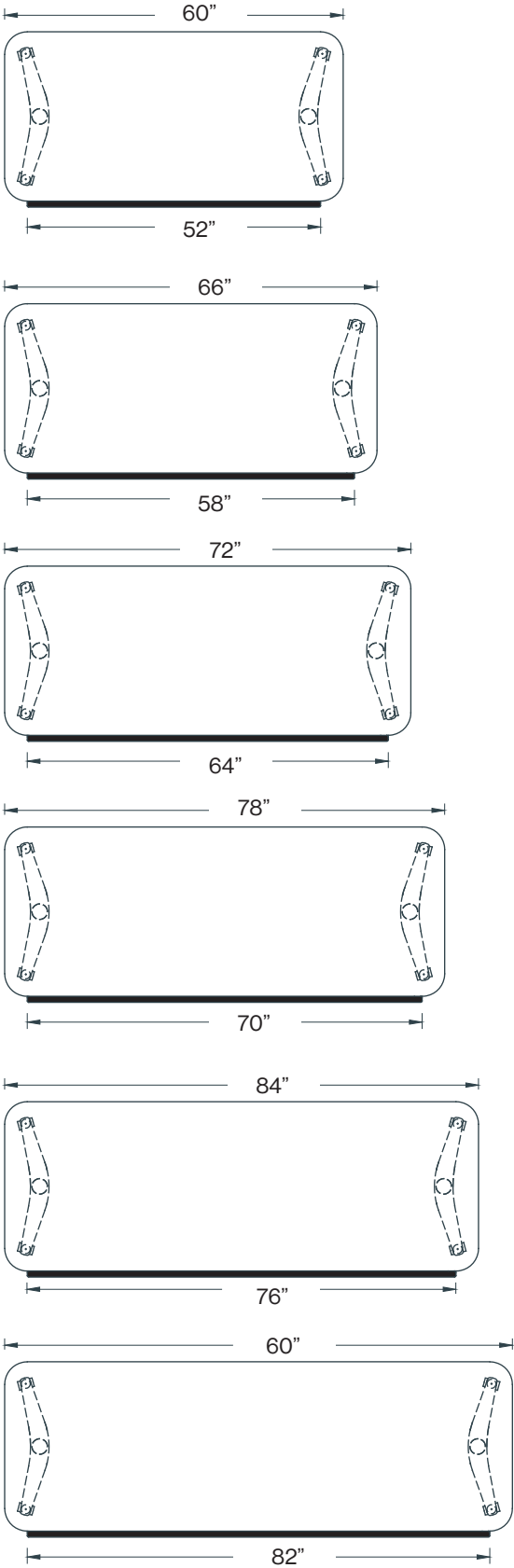

# TERMS AND CONDITIONS OF SALE

---

## PRICES

All prices are list prices, FOB our Toronto Factory- freight charges are extra. Packing and/ or crating is available, if required, upcharges apply.

Due to existing conditions in regard to cost of labor and materials, we reserve the right to change prices without notice.

## TERMS

Net 30 days from date of invoice to accredited buyers. Two per cent (2%) interest charged monthly on overdue accounts. Deposit of 50% is required with order. Terms will be established upon credit evaluation. Due to delays in processing references, first orders may be treated as C.B.D. orders.

## ORDER CONFIRMATION

Orders are accepted upon issuance of our order confirmation and are subject to the terms set forth therein; notwithstanding any variance from the terms of the buyer's order form.

Nienkämper is not liable for any delay or failure to deliver caused by labor or transportation difficulties, accidents, acts of God, failure of sources of supply, or other causes beyond our control, and changes will affect the delivery date.

## CHANGE OF ORDERS OR CANCELLATIONS

Changes or cancellations are subject to our ability to conform. A charge will be levied against canceled or changed orders based on costs already incurred by Nienkämper. All changes must be in writing and submitted on a revised purchase order. Changes will affect the delivery date.

## STORAGE

If goods cannot be accepted when ready, we may transfer them to storage (which is to be deemed as delivery for invoice purposes). The customer accepts risks and will be charged at prevailing rates.

## FREIGHT

All prices are list prices, FOB our Toronto Factory- freight charges are extra.

Packing and/or crating are available, if required, upcharges apply.

## CLAIMS

All furniture is given to the carrier and signed for in good condition. It is the responsibility of the receiver to sign for the goods in the presence of the carrier and note the condition in which they are received. Freight claims should be filed with the carrier.

## WARRANTY

There are no express or implied warranties, conditions and obligations of the manufacturer, whether statutory or otherwise that extend beyond the description on the face hereof. Our furniture is made to the highest standard and is warranted free from defects of material and workmanship for five years from the date of delivery. During the warranty period we will repair or replace such merchandise as shall prove to be defective, during normal usage in accordance with manufacturer's specifications. The manufacturer shall not be liable for defect wholly attributable to normal manufacturing process. Replacement or repair of the Product shall be the sole remedy of the Customer, and the manufacturer shall not be liable for any direct, indirect, incidental, or consequential loss or damage suffered by the Customer by reason of any defect in workmanship or manufacture of the Product or inability to use the Product. Moreover, this warranty does not cover accidental damage, abuse, alteration, ordinary wear and tear of Goods, negligence and misuse nor variations over which we have no control such as heat or humidity or damage to which the Goods are connected that is not attributable to the failure of the goods themselves. This warranty is null and void when the product is installed with hardware other than that supplied and/or when installed differently than recommended in the installation guide. Modification to the product or hardware may result in failure of the product and cause damage and/or injury.

## WOOD FINISHES

Nienkämper offers a wide variety of standard light finishes on cherry, mahogany and figured anagre wood veneers, and a clear natural finish on figured anagre, figured sycamore, maple, bird's eye maple and curly maple.

Light finishes do not mask the grain and other characteristics of each wood species. It is important to understand that pieces of the same type of wood will not look identical when a light finish is used. The appearance of the finish will also depend on the natural color of the veneer. Cherry darkens over time as the wood ages. Pin knots and gum pockets are inherent traits.

Wood is a naturally variable raw material; its variances are not within the furniture manufacturer's control and are therefore not considered defects under this warranty.