

# nienkämpfer

**VOX®**  
FORUMS



**2026**

"M & N" Series Vox Forums Pages 209-228

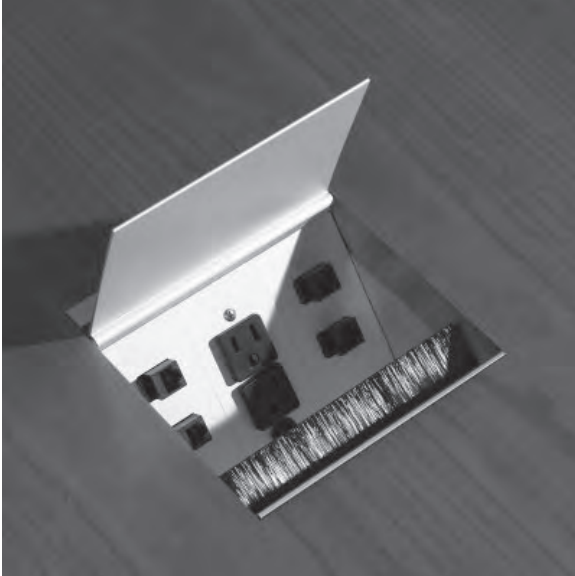

M-Series Forums – 6" wide and N-Series Forums – 12" wide, offer increased capacity and scale. Its modular design makes it simple to configure to your needs

Individual plates can be replaced / retrofitted as required in the field.

# POSITIONING VOX® FORUMS ON CONFERENCE TABLES













## DETERMINING FORUM PLACEMENT ON TABLES

The following table serves as a guideline for defining and distributing Forums along the tabletop. The rectangular icons on the left are for reference only, as all other shapes in the collection fit within this outline.

For tables with Access, Tower, and Drum bases, Forums can be positioned over the base and share the same placement options shown for the Duo base in the chart below.

For LCS Tables or custom Forum positioning, please contact Customer Service at **800.668.9318**.









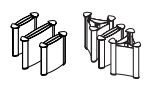

	Tables 72 x 36 - 84 x 42 	Tables 96 x 42 - 108 x 48 	Tables 120 x 42 - 132 x 54 	Tables 144 x 48 - 168 x 66 				
	M-Series Forum	N-Series Forum	M-Series Forum	N-Series Forum	M-Series Forum	N-Series Forum	M-Series Forum	N-Series Forum
 <b>FP1 - At center</b>	•	•	•	•	•	•	• N/A on Duo Base 42" - 48" D	
 <b>FP2C - Centered</b>	•	•	•	•	•	•	• N/A on Duo Base 42" - 48" D	• N/A on Duo Base 48" D
 <b>FP2 - Equally Spaced</b>	•	•	•	•	•	•	• N/A on Duo Base 42" - 48" D	• N/A on Duo Base 48" D
 <b>FP2E - At ends of table</b>			•	•	•	•	• N/A on Duo Base 42" - 48" D	• N/A on Duo Base 48" D
 <b>FP3 - Equally Spaced</b>			•	•	•	•	• N/A on Duo Base 42" - 48" D	
 <b>FP4 - Equally Spaced</b>								
 <b>FP4A - Symmetrically Spaced</b>						•	• N/A on Duo Base 42" - 48" D	• N/A on Duo Base 48" D

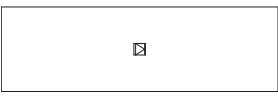
## DETERMINING FORUM PLACEMENT ON TABLES

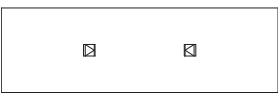
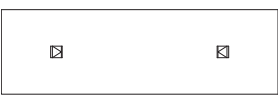
The following table serves as a guideline for defining and distributing Forums along the tabletop. The rectangular icons on the left are for reference only, as all other shapes in the collection fit within this outline.

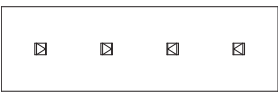
For tables with Access, Tower, and Drum bases, Forums can be positioned over the base and share the same placement options shown for the Duo base in the chart below.

For LCS Tables or custom Forum positioning, please contact Customer Service at **800.668.9318**.

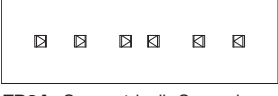
	Tables 180 x 48 - 192 x 72 	Tables 204 x 54 - 216 x 78 	Tables 204 x 54 - 216 x 78 	Tables 228 x 54 - 240 x 84 				
	M-Series Forum	N-Series Forum	M-Series Forum	N-Series Forum	M-Series Forum	N-Series Forum	M-Series Forum	N-Series Forum
 <b>FP1 - At center</b>	• N/A 180", 192" with Duo Base	• N/A on Duo Base 48" D			•	•	•	•
 <b>FP2C - Centered</b>	•	• N/A on Duo Base 48" D	•	•	•	•	•	•
 <b>FP2 - Equally Spaced</b>	•	• N/A on Duo Base 48" D	•	•	•	•	•	•
 <b>FP2E - At ends of table</b>	•	• N/A on Duo Base 48" D	•	•	•	•	•	•
 <b>FP3 - Equally Spaced</b>	• N/A 180", 192" with Duo Base	• N/A on Duo Base 48" D			•	•	•	•
 <b>FP4 - Equally Spaced</b>								
 <b>FP4A - Symmetrically Spaced</b>	•	•	•	•	•	•	•	•
 <b>FP5 - Equally Spaced</b>	• N/A 180", 192" with Duo Base	•			•	•	•	•
 <b>FP6 - Equally Spaced</b>								
 <b>FP6A - Symmetrically Spaced</b>	•	• N/A on Duo Base 48" D	•	•	•	•	•	•

## DETERMINING FORUM PLACEMENT ON TABLES

The following table serves as a guideline for defining and distributing Forums along the tabletop. The rectangular icons on the left are for reference only, as all other shapes in the collection fit within this outline.

For tables with Access, Tower, and Drum bases, Forums can be positioned over the base and share the same placement options shown for the Duo base in the chart below.

For LCS Tables or custom Forum positioning, please contact Customer Service at **800.668.9318**.

	Tables 42" w/ø - 60" w/ø		Tables 42" w/ø - 60" w/ø		Tables 66" w/ø - 72" w/ø		Tables 66" w/ø - 72" w/ø		Tables 78" w/ø - 96" w/ø		Tables 78" w/ø - 96" w/ø		
	Forum Series M N		Forum Series M N		Forum Series M N		Forum Series M N		Forum Series M N		Forum Series M N		
Wave Square Round <b>FP1 - At center</b>	•	•	•	•	•	•	•	•	•	•	•	•	
Wave Square Round <b>FP2C - Centered</b>			N/A 42"	N/A 42", 48"	•	•	•	•	•	•	•	•	
Wave Square Round <b>FP3 - Equally Spaced</b> Round tables only					•	•	•	•	•	•	N/A 78"	N/A 78"	
Wave Square Round <b>FP4 - Equally Spaced</b>					N/A 66"	N/A 66"	N/A 66"	N/A 66"	•	•	N/A 78"	•	•

# DATA/VOICE WIRING OPTIONS



Nienkämper is a **recognized installer** for data systems described in **Vox® Forum products**.

Vox® Forums can be manufactured with several factory wired data systems including "Hubbell", "Leviton", "Siemon", "Belden" and "Legrand/ Ortronics". All of these systems guarantee the highest level of data transmissions.

**Vox® Forum products have been tested by the independent laboratories of these companies and are compliant with all aspects of proper installation and performance.**

Nienkämper recommends the use of these **pre-wired systems** as they offer the **best value, quality** and **safety**.

Options for data/voice connections



- CAT 6A  
(available in custom plate only)

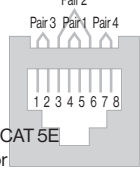
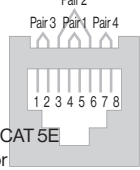

- CAT 5E  
or  
• CAT 6 T568A

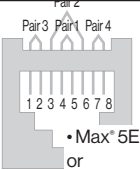
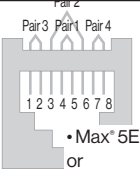

- Max® 5E  
or  
• Max® 6 T568A



- CAT 5E  
or  
• CAT 6



- CAT 5E  
or  
• CAT 6

Nienkämper recommends the use of Vox® **pre-wired systems** as they offer the **best value, quality and safety** to the consumer.

**Standard Vox Forums** are listed by Underwriters Laboratories Inc. under several categories. These listings qualify a level of safety guaranteed by UL's published standards for safety which UL uses as a benchmark for testing and listing products.

The right to bear the UL mark is contingent on the fact that absolutely no alteration is made to the product as it was submitted and tested by Underwriters Laboratories. This is to ensure that assemblies are not manufactured with inferior or replacement parts; this would void or alter the result of the original examination and tests conducted by UL.

The UL mark is included on a label that is attached to the underside of listed Vox® products. This label includes:

- The date the component was assembled and tested.
- A serial number for tracking purposes.
- The listing category located under the UL mark.
- UL file number that can be used as a reference at UL for any inquiries about the product.

## SAMPLE UL/CSA LABEL

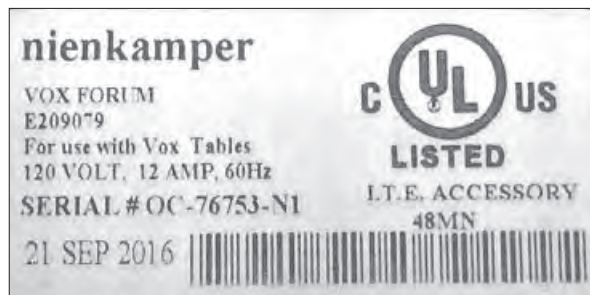

**All listed assemblies have POWER/ELECTRICAL components wired by Nienkämper and undergo the following tests:**

**Production Line Grounding Test - Continuity:** This test checks for grounding continuity between the grounding conductor of the attachment plug and the designated main grounding point including any accessible dead-metal parts of the assembly. There must be grounding continuity between all parts.

**Production-line Dielectric Voltage Withstand Test - Hi-pot:** Each product shall withstand without electrical breakdown, as a routine production-line test, the application of an AC potential at a frequency within the range of 40-70 Hz or a DC potential between the primary wiring, including connected components, and accessible dead metal parts that are likely to become energized. This test is conducted when the product is fully assembled, and cannot be unwired, modified or disassembled afterwards.

**Production-line - Polarity Test:** This test verifies proper electrical polarity of both the grounded (neutral) and the ungrounded (hot) supply circuit conductors of the Forum and all parts intended to be connected to the grounded (neutral) and ungrounded (hot) supply circuit conductors of the attachment plug. Conductivity indications must confirm the correct connection of all parts specified.

# VOX® FORUM CONFIGURATOR

Specifying the “M” and “N” series Vox Forum couldn’t be simpler.

“M” and “N” series Forums can be individually configured online with the “**Vox Forum Configurator**”.

Log onto the Nienkämper website [www.nienkamper.com](http://www.nienkamper.com) and follow the links or simply type [www.vfc3.nienkamper.com](http://www.vfc3.nienkamper.com) in your browser and go straight to this online tool.



Configuring your Forum is easy: simply drag and drop the options you want to build the product you need.

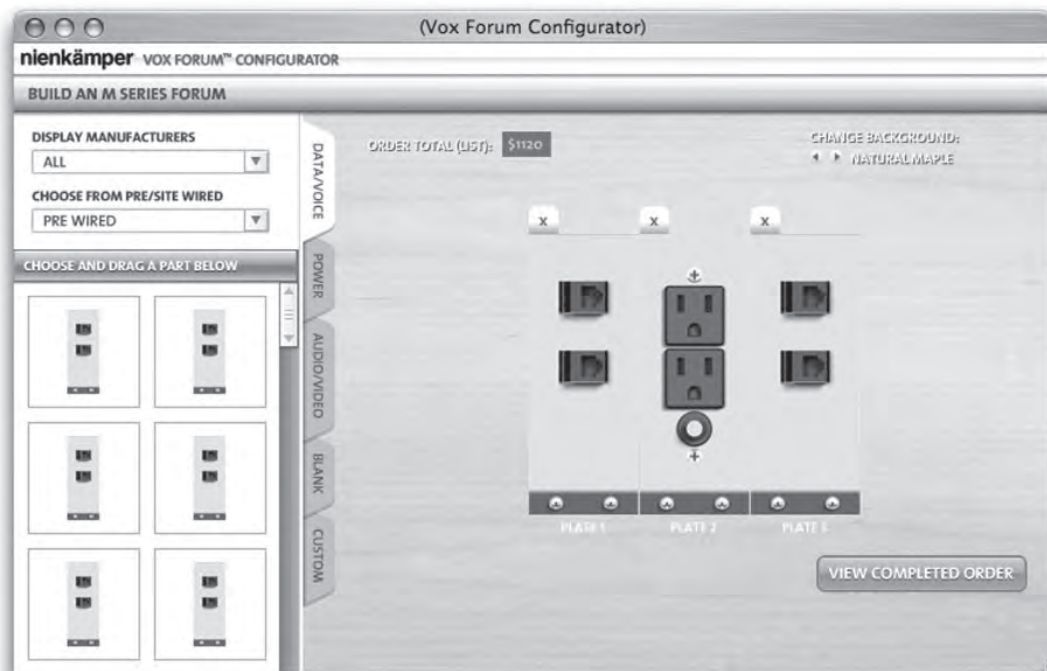

Download this form at [www.nienkamper.com/vfc/forum](http://www.nienkamper.com/vfc/forum)

**Modular Plate #1**      **Modular Plate #2**      **Modular Plate #3**



**Base Model # - M -**    \_\_\_\_\_ -    \_\_\_\_\_ -    \_\_\_\_\_ -

**Modular Plate #1**      **Modular Plate #2**      **Modular Plate #3**

- Select the modular faceplate required from pages 230-234.
- Fill in the 2 digit model number of each plate in the desired location.
- For custom modular plates, fill in "CX" as the model number.
- To create a custom modular plate, turn to pages 236.

**\$ 630**    + \_\_\_\_\_    + \_\_\_\_\_    + \_\_\_\_\_    = \_\_\_\_\_

**Base Model Cost**      **Plate #1 Cost**      **Plate #2 Cost**      **Plate #3 Cost**      **Total Forum Cost**

- Add up the cost.

## Use this section when ordering Custom Modular Faceplates

Place your selection of part numbers from page 186.

		Position A	Position B	Position C
Custom Modular Plate #1 -	<b>CX1</b>	- _____ -	_____ -	_____
Custom Modular Plate #2 -	<b>CX2</b>	- _____ -	_____ -	_____
Custom Modular Plate #3 -	<b>CX3</b>	- _____ -	_____ -	_____

Quote # or Order # : \_\_\_\_\_ Date: \_\_\_\_\_

Approval Signature: \_\_\_\_\_

Download this form at [www.nienkamper.com/vfc/forum](http://www.nienkamper.com/vfc/forum)

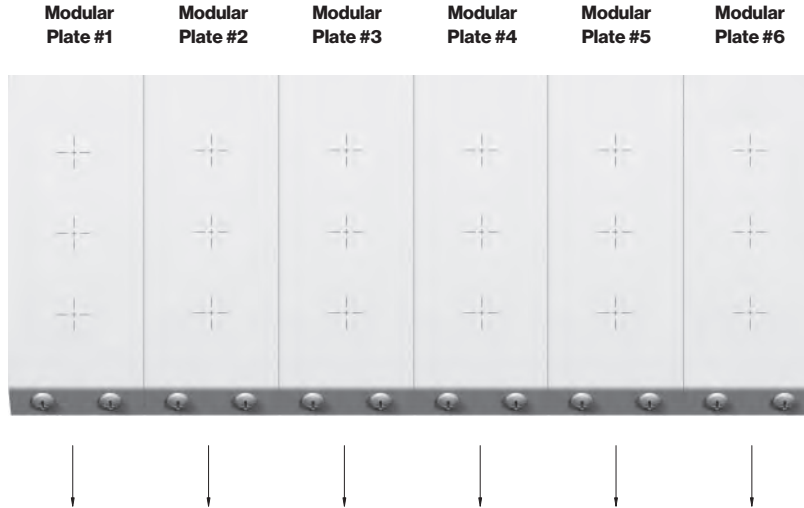

- Select the modular faceplate required from pages 230-235.
- Fill in the 2 digit model number of each plate in the desired location.
- For custom modular plates, fill in "CX" as the model number.
- To create a custom modular plate, turn to pages 236.

**Base Model # - N** - \_\_\_\_\_ - \_\_\_\_\_ - \_\_\_\_\_ - \_\_\_\_\_ - \_\_\_\_\_ - \_\_\_\_\_

<b>Modular Plate #1</b>	<b>Modular Plate #2</b>	<b>Modular Plate #3</b>	<b>Modular Plate #4</b>	<b>Modular Plate #5</b>	<b>Modular Plate #6</b>
-------------------------	-------------------------	-------------------------	-------------------------	-------------------------	-------------------------

<b>\$ 695</b>	+	_____	+	_____	+	_____	+	_____	+	_____	+	_____	=	_____
<b>Base Model Cost</b>		<b>Plate #1 Cost</b>		<b>Plate #2 Cost</b>		<b>Plate #3 Cost</b>		<b>Plate #4 Cost</b>		<b>Plate #5 Cost</b>		<b>Plate #6 Cost</b>		<b>Total Forum Cost</b>

• Add up the cost.

## Use this section when ordering Custom Modular Faceplates

Place your selection of part number from page 186 in the desired location below.

	Position A	Position B	Position C
Custom Modular Plate	<b>CX1</b> - _____	- _____	- _____
Custom Modular Plate	<b>CX2</b> - _____	- _____	- _____
Custom Modular Plate	<b>CX3</b> - _____	- _____	- _____
Custom Modular Plate	<b>CX4</b> - _____	- _____	- _____
Custom Modular Plate	<b>CX5</b> - _____	- _____	- _____
Custom Modular Plate	<b>CX6</b> - _____	- _____	- _____

Quote # or Order # : \_\_\_\_\_ Date: \_\_\_\_\_

Approval Signature: \_\_\_\_\_

# "M & N" SERIES VOX® FORUM – MODULAR FACEPLATES



SINGLE MODULE FACEPLATE CONTAINS THE FOLLOWING: 2-DATA



Model Number	List Price	Pre Wired – All Cords Terminated With Male Plugs
<b>OE</b>	<b>395</b>	<b>2 - Hubbell Cat5e Data, 10' Cord</b>
1E	795	2 - Hubbell Cat6 Data, 10' Cord
<b>2E</b>	<b>585</b>	<b>2 - Leviton Cat5e Data, 10' Cord</b>
3E	795	2 - Leviton Cat6 Data, 10' Cord
<b>4E</b>	<b>585</b>	<b>2 - Siemon Cat5e Data, 16' Cord</b>
5E	795	2 - Siemon Cat6 Data, 16' Cord
<b>6E</b>	<b>585</b>	<b>2 - Belden Cat5e Data, 10' Cord</b>
7E	795	2 - Belden Cat6 Data, 10' Cord
<b>8E</b>	<b>695</b>	<b>2 - Ortronics Cat5e Data, 10' Cord</b>
9E	785	2 - Ortronics Cat6 Data, 10' Cord

Model Number	List Price	Site Wired – Only Jacks Supplied
<b>OB</b>	<b>350</b>	<b>2 - Hubbell Cat5e Data, Site Wiring Required</b>
1B	490	2 - Hubbell Cat6 Data, Site Wiring Required
<b>2B</b>	<b>350</b>	<b>2 - Leviton Cat5e Data, Site Wiring Required</b>
3B	490	2 - Leviton Cat6 Data, Site Wiring Required
<b>4B</b>	<b>350</b>	<b>2 - Siemon Cat5e Data, Site Wiring Required</b>
5B	490	2 - Siemon Cat6 Data, Site Wiring Required
<b>6B</b>	<b>350</b>	<b>2 - Belden Cat5e Data, Site Wiring Required</b>
7B	490	2 - Belden Cat6 Data, Site Wiring Required
<b>8B</b>	<b>350</b>	<b>2 - Ortronics Cat5e Data, Site Wiring Required</b>
9B	435	2 - Ortronics Cat6 Data, Site Wiring Required

SINGLE MODULE FACEPLATE CONTAINS THE FOLLOWING: 1-DATA, 1-VOICE



Model Number	List Price	Pre Wired – All Cords Terminated With Male Plugs
<b>OK</b>	<b>365</b>	<b>1 - Hubbell Cat5e Data &amp; 1-Rj45 Voice - 10' Cords</b>
1K	585	1 - Hubbell Cat6 Data & 1-Rj45 Voice - 10' Cords
<b>2K</b>	<b>605</b>	<b>1 - Leviton Cat5e Data &amp; 1-Rj45 Voice - 10' Cords</b>
3K	700	1 - Leviton Cat6 Data & 1-Rj45 Voice - 10' Cords
<b>4K</b>	<b>605</b>	<b>1 - Siemon Cat5e Data &amp; 1-Rj45 Voice - 16' Cords</b>
5K	700	1 - Siemon Cat6 Data & 1-Rj45 Voice - 16' Cords
<b>6K</b>	<b>605</b>	<b>1 - Belden Cat5e Data &amp; 1-Rj45 Voice - 10' Cords</b>
7K	700	1 - Belden Cat6 Data & 1-Rj45 Voice - 10' Cords
<b>8K</b>	<b>595</b>	<b>1 - Ortronics Cat5e Data &amp; 1-Rj45 Voice - 10' Cords</b>
9K	640	1 - Ortronics Cat6 Data & 1-Rj45 Voice - 10' Cords

Model Number	List Price	Site Wired – Only Jacks Supplied
<b>OJ</b>	<b>325</b>	<b>1 - Hubbell Cat5e Data &amp; 1-Rj45 Voice - Site Wired</b>
1J	375	1 - Hubbell Cat6 Data & 1-Rj45 Voice - Site Wired
<b>2J</b>	<b>350</b>	<b>1 - Leviton Cat5e Data &amp; 1-Rj45 Voice - Site Wired</b>
3J	410	1 - Leviton Cat6 Data & 1-Rj45 Voice - Site Wired
<b>4J</b>	<b>350</b>	<b>1 - Siemon Cat5e Data &amp; 1-Rj45 Voice - Site Wired</b>
5J	410	1 - Siemon Cat6 Data & 1-Rj45 Voice - Site Wired
<b>6J</b>	<b>350</b>	<b>1 - Belden Cat5e Data &amp; 1-Rj45 Voice - Site Wired</b>
7J	410	1 - Belden Cat6 Data & 1-Rj45 Voice - Site Wired
<b>8J</b>	<b>350</b>	<b>1 - Ortronics Cat5e Data &amp; 1-Rj45 Voice - Site Wired</b>
9J	400	1 - Ortronics Cat6 Data & 1-Rj45 Voice - Site Wired

SINGLE MODULE FACEPLATE CONTAINS THE FOLLOWING: 3-DATA



Model Number	List Price	Pre Wired – All Cords Terminated With Male Plugs
<b>OF</b>	<b>545</b>	<b>3 - Hubbell Cat5e Data, 10' Cord</b>
1F	1,150	3 - Hubbell Cat6 Data, 10' Cord
<b>2F</b>	<b>815</b>	<b>3 - Leviton Cat5e Data, 10' Cord</b>
3F	1,150	3 - Leviton Cat6 Data, 10' Cord
<b>4F</b>	<b>815</b>	<b>3 - Siemon Cat5e Data, 16' Cord</b>
5F	1,150	3 - Siemon Cat6 Data, 16' Cord
<b>6F</b>	<b>815</b>	<b>3 - Belden Cat5e Data, 10' Cord</b>
7F	1,150	3 - Belden Cat6 Data, 10' Cord
<b>8F</b>	<b>1,015</b>	<b>3 - Ortronics Cat5e Data, 10' Cord</b>
9F	1,135	3 - Ortronics Cat6 Data, 10' Cord

Model Number	List Price	Site Wired – Only Jacks Supplied
<b>OC</b>	<b>470</b>	<b>3 - Hubbell Cat5e Data, Site Wiring Required</b>
1C	685	3 - Hubbell Cat6 Data, Site Wiring Required
<b>2C</b>	<b>470</b>	<b>3 - Leviton Cat5e Data, Site Wiring Required</b>
3C	685	3 - Leviton Cat6 Data, Site Wiring Required
<b>4C</b>	<b>470</b>	<b>3 - Siemon Cat5e Data, Site Wiring Required</b>
5C	685	3 - Siemon Cat6 Data, Site Wiring Required
<b>6C</b>	<b>470</b>	<b>3 - Belden Cat5e Data, Site Wiring Required</b>
7C	685	3 - Belden Cat6 Data, Site Wiring Required
<b>8C</b>	<b>470</b>	<b>3 - Ortronics Cat5e Data, Site Wiring Required</b>
9C	625	3 - Ortronics Cat6 Data, Site Wiring Required

SINGLE MODULE FACEPLATE CONTAINS THE FOLLOWING: 2-DATA, 1-VOICE



Model Number	List Price	Pre Wired – All Cords Terminated With Male Plugs
<b>OM</b>	<b>490</b>	<b>2 - Hubbell Cat5e Data &amp; 1-Rj45 Voice - 10' Cords</b>
1M	905	2 - Hubbell Cat6 Data & 1-Rj45 Voice - 10' Cords
<b>2M</b>	<b>815</b>	<b>2 - Leviton Cat5e Data &amp; 1-Rj45 Voice - 10' Cords</b>
3M	1,025	2 - Leviton Cat6 Data & 1-Rj45 Voice - 10' Cords
<b>4M</b>	<b>815</b>	<b>2 - Siemon Cat5e Data &amp; 1-Rj45 Voice - 16' Cords</b>
5M	1,025	2 - Siemon Cat6 Data & 1-Rj45 Voice - 16' Cords
<b>6M</b>	<b>815</b>	<b>2 - Belden Cat5e Data &amp; 1-Rj45 Voice - 10' Cords</b>
7M	1,025	2 - Belden Cat6 Data & 1-Rj45 Voice - 10' Cords
<b>8M</b>	<b>1,015</b>	<b>2 - Ortronics Cat5e Data &amp; 1-Rj45 Voice - 10' Cords</b>
9M	1,095	2 - Ortronics Cat6 Data & 1-Rj45 Voice - 10' Cords

Model Number	List Price	Site Wired – Only Jacks Supplied
<b>OL</b>	<b>420</b>	<b>2 - Hubbell Cat5e Data &amp; 1-Rj45 Voice - Site Wired</b>
1L	585	2 - Hubbell Cat6 Data & 1-Rj45 Voice - Site Wired
<b>2L</b>	<b>470</b>	<b>2 - Leviton Cat5e Data &amp; 1-Rj45 Voice - Site Wired</b>
3L	625	2 - Leviton Cat6 Data & 1-Rj45 Voice - Site Wired
<b>4L</b>	<b>470</b>	<b>2 - Siemon Cat5e Data &amp; 1-Rj45 Voice - Site Wired</b>
5L	625	2 - Siemon Cat6 Data & 1-Rj45 Voice - Site Wired
<b>6L</b>	<b>470</b>	<b>2 - Belden Cat5e Data &amp; 1-Rj45 Voice - Site Wired</b>
7L	625	2 - Belden Cat6 Data & 1-Rj45 Voice - Site Wired
<b>8L</b>	<b>460</b>	<b>2 - Ortronics Cat5e Data &amp; 1-Rj45 Voice - Site Wired</b>
9L	585	2 - Ortronics Cat6 Data & 1-Rj45 Voice - Site Wired

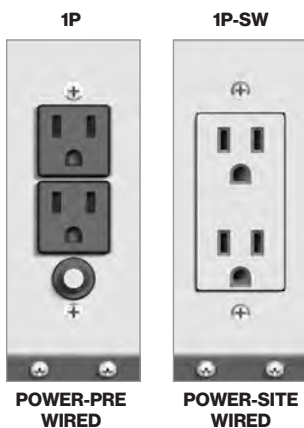

Model Number	List Price
1P	605
1P- SW	625

### SINGLE MODULE FACEPLATE - POWER RECEPTACLES:

#### DESCRIPTION

Single module faceplate contains the following: 2 power receptacles 15A 120V pre wired with 10' cord and plug. Includes 12.5 amp overload protector.

Single module faceplate with - 1 duplex power receptacle/ 15A-120V. Comes with strain relief and 36" of metallic shielded cable wired to receptacle. Site Connection to power source required

**\*Face plate formerly labeled 2P has been changed to 1P-SW.**

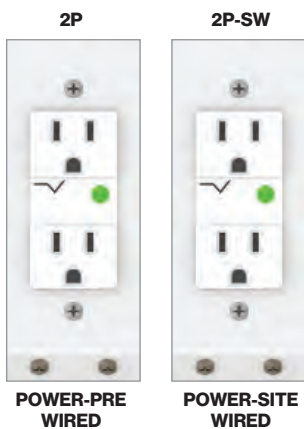

Model Number	List Price
2P	1,255
2P- SW	1,225

### SINGLE MODULE FACEPLATE - POWER RECEPTACLES:

#### DESCRIPTION

Single module faceplate with - 1 duplex power receptacle/ 15A-120V. With Surge Suppressor -, 240 joules/ 15000a per mode and light. Prewired with 10' cord and plug.

Single module faceplate with - 1 duplex power receptacle/ 15A-120V. With surge suppressor, 240 joules/ 15000a per mode and light. Comes with strain relief and 36" of metallic shielded cable wired to receptacle. Site Connection to power source required

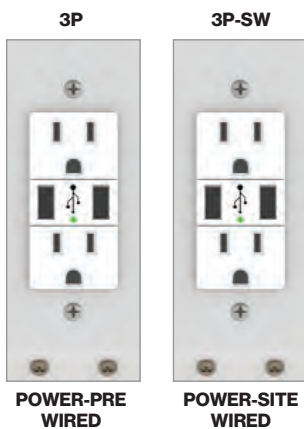

Model Number	List Price
3P	1,040
3P- SW	1,010

### SINGLE MODULE FACEPLATE - POWER RECEPTACLES:

#### DESCRIPTION

Single module faceplate with - 1 duplex power receptacle/ 15A-120V. With 2 USB ports 3 Amp/ 5VDC Type a 2.0. Pre wired with 10' cord & plug

Single module faceplate with - 1 duplex power receptacle/ 15A-120V. With 2 USB ports 3 Hubbell/ 5VDC Type a 2.0. Comes with strain relief and 36" of metallic shielded cable wired to receptacle. Site Connection to power source required



Model Number	List Price
4P	1,200
4P- SW	1,155

### SINGLE MODULE FACEPLATE - POWER RECEPTACLES:

#### DESCRIPTION

Single module faceplate with - 1 duplex power receptacle/ 15A-120V. With USB A + C charging (5V, 5A) 55W. Pre wired with 10' cord & plug

Single module faceplate with - 1 duplex power receptacle/ 15A-120V. With USB A + C charging (5V, 5A) 55W. With 36" metallic shielded cable wired to receptacle. Site connection to power source required

5P



**POWER-PRE WIRED**

5P-SW



**POWER-SITE WIRED**

SINGLE MODULE FACEPLATE - POWER RECEPTACLES:

Model Number	List Price
--------------	------------

5P	1,380
----	-------

5P-SW	1,335
-------	-------

**DESCRIPTION**

Single module faceplate contains the following: 1 duplex power receptacle 15A-120V, with USB C+C charging (5V, 5A) 55W and pre wired 10' cord

Single module faceplate contains the following: 1 duplex power receptacle 15A-120V, with USB C+C charging (5V, 5A) 55W and 36" metallic shielded cable wired to receptacle. Site connection to power source required.

OT - 9T



SINGLE MODULE FACEPLATE:

Model Number	List Price	Pre Wired – All Cords Terminated With Male Plugs
--------------	------------	--

<b>0T</b>	<b>515</b>	<b>1 - Hubbell Cat5e Data, 10' Cord</b>
1T	700	1 - Hubbell Cat6 Data, 10' Cord
<b>2T</b>	<b>605</b>	<b>1 - Leviton Cat5e Data, 10' Cord</b>
3T	700	1 - Leviton Cat6 Data, 10' Cord
<b>4T</b>	<b>605</b>	<b>1 - Siemon Cat5e Data, 16' Cord</b>
5T	700	1 - Siemon Cat6 Data, 16' Cord
<b>6T</b>	<b>605</b>	<b>1 - Belden Cat5e Data, 10' Cord</b>
7T	700	1 - Belden Cat6 Data, 10' Cord
<b>8T</b>	<b>675</b>	<b>1 - Ortronics Cat5e Data, 10' Cord</b>
9T	695	1 - Ortronics Cat6 Data, 10' Cord

**DESCRIPTION**

Single module faceplate contains the following:  
 1 - HD-DB15 (female) with 18" cord and male plug.  
 1 - 3.5mm stereo with 18" cord and male plug.  
 1 - DATA (OT-9T) with 10' cord and male plug.

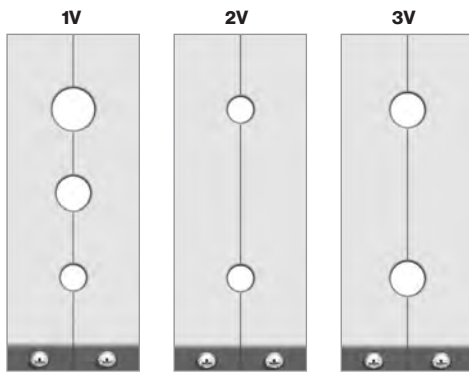

Model Number	List Price
1V	125
2V	125
3V	125

### SINGLE MODULE FACEPLATE:

#### **DESCRIPTION**

Single module split plate assembly contains the following: 3 cutouts - inside diameter sizes - 3/8", 1/2", 5/8" for pass-through cable requirements.

Single module split faceplate contains the following: 2 cutouts - inside diameter sizes - 3/8" for pass-through cable requirements.

Single module split faceplate contains the following: 2 cutouts - inside diameter sizes - 1/2" for pass-through cable requirements.

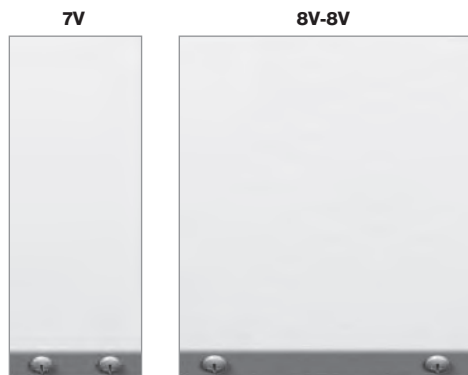

Model Number	List Price
7V	105
8V-8V	125

### BLANK FACEPLATES:

#### **DESCRIPTION**

Single module blank faceplate

Double module blank faceplate

single module

double module

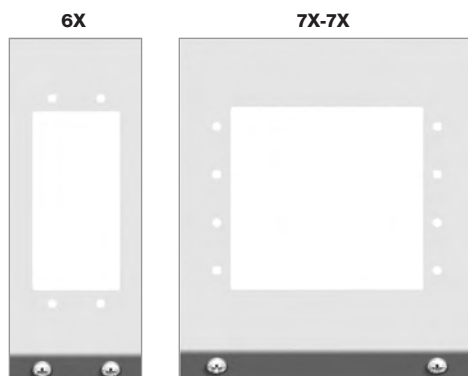

Model Number	List Price
6X	125
7X-7X	150

### EXTRON "AAP" SERIES

#### **DESCRIPTION**

Single module adopter  
-holds two Extron "AAP" modules in vertical position

Double module adopter  
-holds four Extron "AAP" modules in horizontal position

Please refer to your Extron product catalogue for specific "AAP" module model numbers available

single module  
vertical  
alignment

double module  
horizontal  
alignment

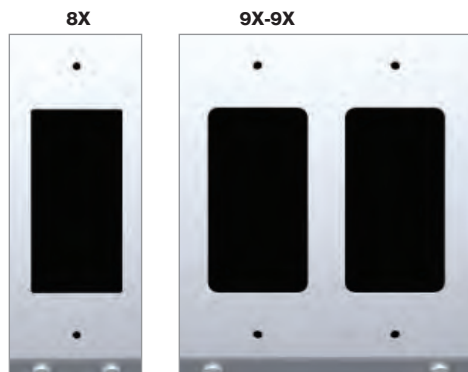

Model Number	List Price
8X	125
9X-9X	150

### DECORA® INSERT PLATES

Single module, holds 1 Decora style insert (supplied by others)

Double module, holds 2 Decora style inserts (supplied by others)

single module

double module

# "M & N" SERIES VOX® FORUM – MODULAR FACEPLATES



## EXTRON RETRACTOR FACEPLATE/RETRACTOR INCLUDED:

(Note: Retractors provided; choose from list below)



Model Number	List Price
5R	470
6R-6R	650



- 5R Retractor Faceplate with R-01 VGA Retractor Series II
- 5R Retractor Faceplate with R-02 3.5mm Audio Retractor Series II
- 5R Retractor Faceplate with R-03 Data-CAT 6 Retractor Series II
- 5R Retractor Faceplate with R-04 HDMI Retractor Series II
- 5R Retractor Faceplate with R-05 USB (signal) Retractor Series II
- 5R Retractor Faceplate with R-06 VGA & Audio Retractor Series II
- 5R Retractor Faceplate with R-13 Display Port Retractor Series II
- 5R Retractor Faceplate with R-14 USB-C Pro 8K Retractor Series II

## EXTRON RETRACTOR OPTIONS:

Model Number	List Price	Description
RA-02	280	Blank filler plate
<b>SERIES 2</b>		
<b>R-01</b>	<b>1,560</b>	<b>VGA - Retractor series II - with 36" long cord</b>
R-02	1,560	3.5mm audio - retractor series II - with 36" long cord
<b>R-03</b>	<b>1,560</b>	<b>Data - CAT 6 - retractor series II - with 36" long cord</b>
R-04	1,560	HDMI - retractor series II - with 36" long cord
<b>R-05</b>	<b>1,560</b>	<b>USB (signal) - retractor series II - with 36" long cord / USB-A to USB-A</b>
R-06	1,730	VGA & audio - retractor series II - with 36" long cord / VGA M-M & 3.5mm audio
<b>R-13</b>	<b>1,730</b>	<b>Display Port - retractor series II - with 36" long cord</b>
R-14	1,995	USB-C Pro 8K - retractor series II - with 36" long cord / USB-C to USB-C
<b>SERIES 2 XL</b>		
<b>R-07</b>	<b>1,730</b>	<b>VGA - Retractor series II XL - with 60" long cord</b>
R-08	1,730	3.5mm audio - retractor series II XL - with 60" long cord
<b>R-09</b>	<b>1,730</b>	<b>Data - CAT 6 - retractor series II XL - with 60" long cord</b>
R-10	1,730	HDMI - retractor series II XL - with 60" long cord
<b>R-11</b>	<b>1,730</b>	<b>USB (signal) - retractor series II XL - with 60" long cord / USB-A to USB-A</b>
R-12	1,905	VGA & audio - retractor series II XL - with 60" long cord / VGA M-M & 3.5mm audio
<b>R-15</b>	<b>1,905</b>	<b>Display Port - retractor series II XL - with 60" long cord</b>
R-14	2,170	USB-C Pro 8K XL - retractor series II - with 60" long cord / USB-C to USB-C

# "M & N" SERIES VOX® FORUM – MODULAR FACEPLATES

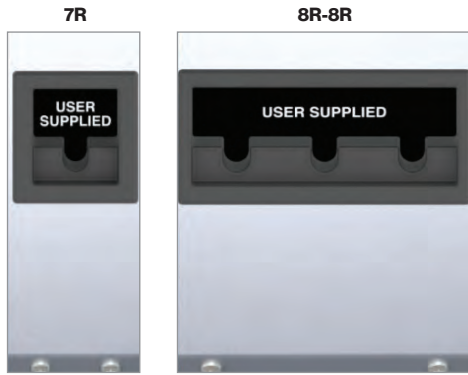

Model Number	List Price
7R	370
8R-8R	555

EXTRON RETRACTOR FACEPLATE/RETRACTOR NOT INCLUDED:  
 (Note: Retractors to be provided and installed by others)

DESCRIPTION
Single faceplate holds 1 Extron Retractor
Double faceplate holds up to 3 Extron Retractors

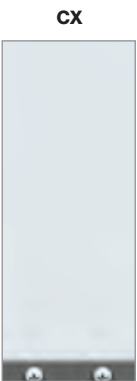

### SINGLE CUSTOM MODULE FACEPLATE (SEE BELOW)

Model Number	List Price
CX	105

**DESCRIPTION**  
 To build your Forum, select fittings from page 186.

## HOW TO ORDER

1. From the list of jacks select the part number that describes your selection
2. Place the part number in one of three positions on the faceplate illustration "A", "B", or "C".
3. Fill in the associated List \$ of each fitting - total the cost.
4. Fill in the model number and transfer it to the proper position on the Forum order page 179 (6" Forum) or page 180 (12" Forum).
5. Add each modular plate price to complete the total Vox Forum list price.

Complete this for each custom plate required.

	Fitting Cost	
Position A	→ <input type="text"/>	- _____
Position B	→ <input type="text"/>	- _____
Position C	→ <input type="text"/>	- _____
	<input type="checkbox"/> <input type="checkbox"/>	+ \$105.00 plate cost
=====		<b>Total Cost</b>
	Position A      Position B      Position C	
Model Number	CX - _____ - _____ - _____	

# "M & N" SERIES VOX® FORUM FACEPLATE CUSTOM MODULE ORDER FORM



**Part Number Pre-Wired List Price**

**Part Number Site-Wired List Price**



<b>A0</b>	<b>Hubbell - CAT 5E Data - 10' Cord</b>	<b>255</b>
A1	Hubbell - CAT 6 Data - 10' Cord	460
<b>A1A</b>	<b>Hubbell CAT 6A Data - 10' Cord</b>	<b>655</b>



<b>AX</b>	<b>Hubbell - CAT 5E Data - No Cord</b>	<b>200</b>
A1X	Hubbell - CAT 6 Data - No Cord	310
<b>A1AX</b>	<b>Hubbell - CAT 6A Data - No Cord</b>	<b>330</b>



<b>A2</b>	<b>Leviton - CAT 5E Data - 10' Cord</b>	<b>365</b>
A3	Leviton - CAT 6 Data - 10' Cord	460
<b>A3A</b>	<b>Leviton - CAT 6A Data - 10' Cord</b>	<b>730</b>



<b>A2X</b>	<b>Leviton - CAT 5E Data - No Cord</b>	<b>200</b>
A3X	Leviton - CAT 6 Data - No Cord	310
<b>A3AX</b>	<b>Leviton - CAT 6A Data - No Cord</b>	<b>370</b>



<b>A4</b>	<b>Siemon - CAT 5E Data - 16' Cord</b>	<b>365</b>
A5	Siemon - CAT 6 Data - 16' Cord	460
<b>A5A</b>	<b>Siemon - CAT 6A Data - 16' Cord</b>	<b>625</b>



<b>A4X</b>	<b>Siemon - CAT 5E Data - No Cord</b>	<b>200</b>
A5X	Siemon - CAT 6 Data - No Cord	310
<b>A5AX</b>	<b>Siemon - CAT 6A Data - No Cord</b>	<b>330</b>



<b>A6</b>	<b>Beldon - CAT 5E Data - 10' Cord</b>	<b>365</b>
A7	Beldon - Cat 6 Data - 10' Cord	460
<b>A7A</b>	<b>Beldon - CAT 6A Data - 10' Cord</b>	<b>615</b>



<b>A6X</b>	<b>Beldon - CAT 5E Data - No Cord</b>	<b>200</b>
A7X	Beldon - CAT 6 Data - No Cord	310
<b>A7AX</b>	<b>Beldon - CAT 6A Data - No Cord</b>	<b>330</b>



<b>A8</b>	<b>Ortronics - CAT 5E Data - 10' Cord</b>	<b>410</b>
A9	Ortronics - CAT 6 Data - 10' Cord	455
<b>A9A</b>	<b>Ortronics - CAT 6A Data - 10' Cord</b>	<b>640</b>



<b>A8X</b>	<b>Ortronics - CAT 5E Data - No Cord</b>	<b>200</b>
A9X	Ortronics - CAT 6 Data - No Cord	290
<b>A9AX</b>	<b>Ortronics - CAT 6A Data - No Cord</b>	<b>315</b>
A11AX	Hubbell - CAT 6A Data - No Cord	330



B	Hubbell - Voice - 10' Cord	190
---	----------------------------	-----



BX	Hubbell - Voice - No Cord	175
----	---------------------------	-----



B1	Leviton - Voice - 10' Cord	365
----	----------------------------	-----



B1X	Leviton - Voice - No Cord	200
-----	---------------------------	-----



B2	Siemon - Voice - 10' Cord	365
----	---------------------------	-----



B2X	Siemon - Voice - No Cord	200
-----	--------------------------	-----



B3	Belden/ CDT - Voice - 10' Cord	365
----	--------------------------------	-----



B3X	Beldon - Voice - No Cord	200
-----	--------------------------	-----



B4	Ortronics - Voice - 10' Cord	410
----	------------------------------	-----



B4X	Ortronics - Voice - No Cord	200
-----	-----------------------------	-----



C	Audio - 3.5mm - 18" Cord	185
---	--------------------------	-----

O	Custom Fitting - No Cord Sample Req	145
---	-------------------------------------	-----



G	HD-DB15 - 18" Cord	290
---	--------------------	-----

P	Empty / No Fitting Required	
---	-----------------------------	--



H	USB - 24" Cord	225
---	----------------	-----



HB	USB Type B - 24" Cord	175
----	-----------------------	-----



HD	HDMI - 24" Cord	310
----	-----------------	-----



J1	XLR / 3 Pin / - 18" Cord	330
----	--------------------------	-----

**FACEPLATE CONNECTIONS ARE FEMALE, SUPPLY CORD PLUGS ARE MALE.  
DB9 FACEPLATE FITTINGS ARE MALE, DB9 SUPPLY CORD PLUGS ARE FEMALE.**

THIS DOCUMENT IS CONFIDENTIAL AND PROPRIETARY. NO PART OF THIS DRAWING MAY BE COPIED OR DISCLOSED TO ANY THIRD PARTY OR USED FOR ANY PURPOSE WITHOUT THE EXPRESS WRITTEN AUTHORIZATION OF NIENKÄMPER INTERNATIONAL INC.



**VOX® DOUBLE SIDED FORUM**

# INTRODUCTION



## Standard Features

The Vox® Double-Sided Forum features a multi-directional hinged lid, providing access from either side of the table. The Forum sits flush with the tabletop, and the lid matches the work surface finish. A thin aluminum bezel lines the cutout in both the tabletop and lid for added durability and a color detail.

The Vox® Double-Sided Forum is available in a 4-module configuration. Modules can be specified as Power/Charging, Data/AV, Split Plates, or Retractors. Modules can be swapped or repositioned on site if your power or AV requirements change.

Power modules include:

3 simplexes, or 2 simplexes with USB-A or USB-C charging

Power units are available with a pre-wired cord, hardwired feed, or daisy-chain feed.

Data/AV plates contain 4 fittings. Individual fittings can be swapped out, or the entire plate can be replaced on site as needed.

## FINISHES

The Vox® Double-Sided Forum is constructed from sturdy aluminum and finished with a durable powder coat. The body is available in Black, Gray, or White powder coat. The lid is matched to the veneer, plastic laminate or engineered stone used on the tabletop for a seamless look.

Custom powder coat colors are available upon request; please note that this may affect pricing and lead times. Contact Nienkamper Customer Service at **800.668.9318**.

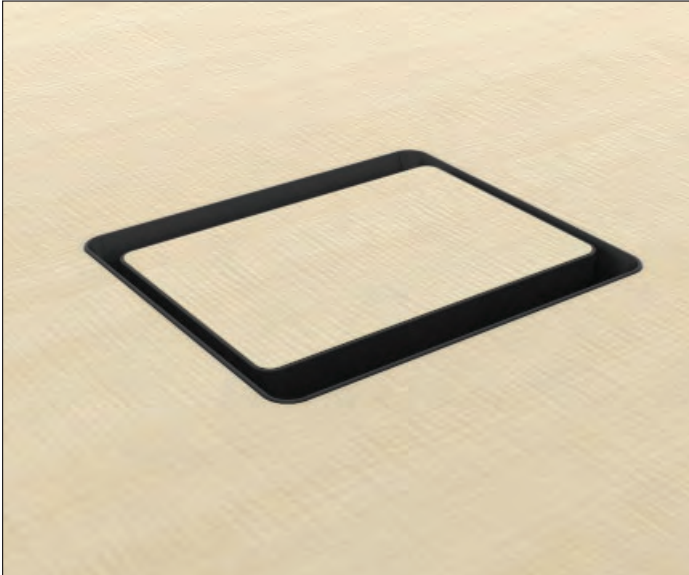

BLACK

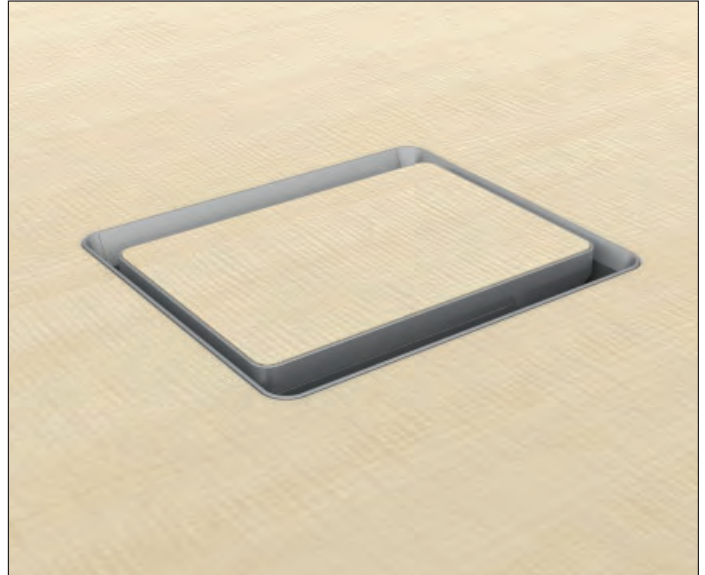

GRAY



WHITE



CUSTOM

# VOX® DOUBLE SIDED FORUM - ORDER FORM

THE VOX® DOUBLE SIDED FORUM HAS 4 PORTS THAT CAN BE POPULATED WITH VARIOUS FACE PLATES.

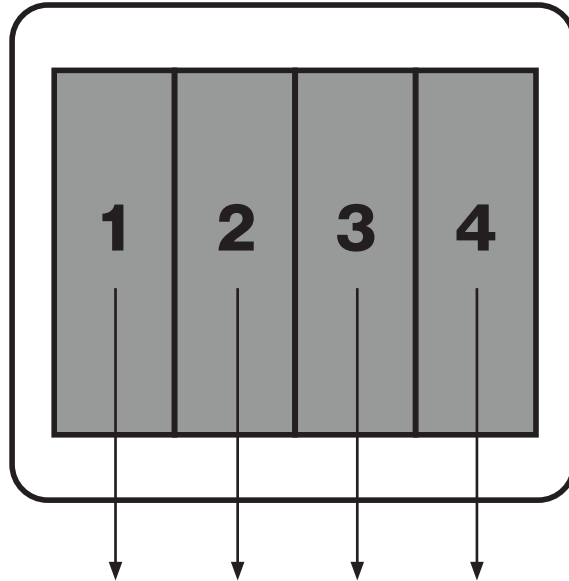

**Base Model# - G-**

\_\_\_\_\_ - \_\_\_\_\_ - \_\_\_\_\_ - \_\_\_\_\_  
 PLATE 1    PLATE 2    PLATE 3    PLATE 4

- Select the modular faceplate required from pages 241-243.
- Fill in the 2 digit model number of each plate in the desired location.
- For custom modular plates, fill in "CX" as the model number.

**\$970** + \_\_\_\_\_ + \_\_\_\_\_ + \_\_\_\_\_ + \_\_\_\_\_ = \_\_\_\_\_  
 BASE MODEL COST    PLATE #1 COST    PLATE #2 COST    PLATE #3 COST    PLATE #4 COST

• Add up the cost

\*Base model cost includes finished veneer or plastic laminate lid.

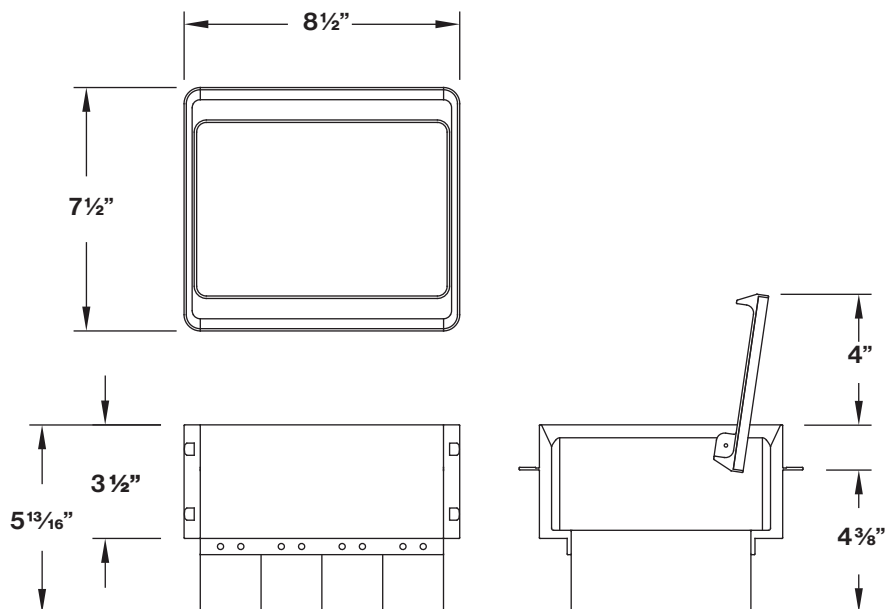

# POWER FACEPLATES

---

## DS-1P



Model Number	List Price
<b>DS-1P</b>	\$265
<b>DS-1P-SW</b>	\$300
<b>DS-1P-4T</b>	\$295

### DESCRIPTION

- Single module faceplate contains 3 power receptacles 15A 120V
- Pre wired with a 10' cord.
- Site wired with a 72" metallic shielded cable.
- Site connection to power source required.
- Comes with a daisy chain wire system that runs on two circuits
- Site connection to power source required.

## DS-2P



Model Number	List Price
<b>DS-2P</b>	\$365
<b>DS-2P-SW</b>	\$410
<b>DS-2P-4T</b>	\$400

### DESCRIPTION

- Single module faceplate contains 2 power receptacles 15A 120V,
- 2 USB-A, with 2 Amps per port.
- Pre wired with a 10' cord.
- Site wired with a 72" metallic shielded cable.
- Site connection to power source required.
- Comes with a daisy chain wire system that runs on two circuits
- Site connection to power source required.

# POWER FACEPLATES

---

## DS-3P



MODEL NUMBER	LIST PRICE
<b>DS-3P</b>	\$365
<b>DS-3P-SW</b>	\$410
<b>DS-3P-4T</b>	\$400

### DESCRIPTION

- Single module faceplate contains 2 power receptacles 15A 120V,
- USB-A+C, with 2 Amps per port 18W.
- Pre wired with a 10' cord.
- Site wired with a 72" metallic shielded cable.
- Site connection to power source required.
- Comes with a daisy chain wire system that runs on two circuits
- Site connection to power source required.

## DS-4P

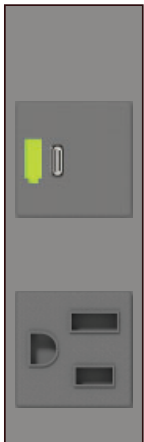

MODEL NUMBER	LIST PRICE
<b>DS-4P</b>	\$555
<b>DS-4P-SW</b>	\$605
<b>DS-4P-4T</b>	\$595

### DESCRIPTION

- Single module faceplate contains 1 power receptacle 15A 120V,
- 1 USB-C, with 100W
- Pre wired with a 10' cord.
- Site wired with a 72" metallic shielded cable.
- Site connection to power source required.
- Comes with a daisy chain wire system that runs on two circuits
- Site connection to power source required.

## SPLIT PLATE

---

### DS-SP

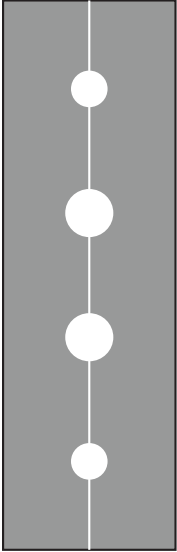

MODEL NUMBER	LIST PRICE
<b>DS-SP</b>	\$100
	PLATE ONLY

#### DESCRIPTION

- Split plate has 2 openings that are 3/8" diameter and 2 openings at 7/16" diameter.

## BLANK PLATE

---

### DS-BP

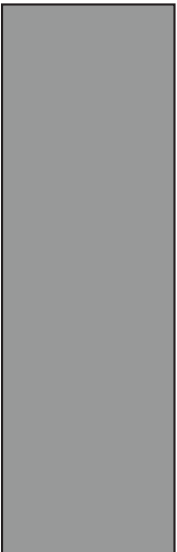

MODEL NUMBER	LIST PRICE
<b>DS-BP</b>	\$100
	PLATE ONLY

#### DESCRIPTION

- Blank plate used as filler within Forum.

# CUSTOM AV/DATA FACE-PLATES

## DS-CX

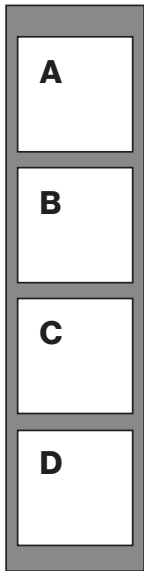

**MODEL NUMBER**

**POSITION A**

**POSITION B**

**POSITION C**

**POSITION D**

**+ \$100 PLATE COST**

### DESCRIPTION

The CX plate has 4 spaces for fittings and can be used in any position in the forum.

MODEL NUMBER	CX-			
	POSITION A	POSITION B	POSITION C	POSITION D



**A5      \$190**

SIEMON CAT 6 data fitting with 10' connector cable (Female to Male)



**C      \$95**

Audio- 3.5mm Mini stereo Jack with 10' cord (Female to Male)



**H      \$145**

USB port 3.0 with 10' cord (Female to Male)



**G      \$205**

DB15HD, VGA connector, 10' cord (Female to Male)



**HD      \$205**

HDMI coupler (female to female) with 18" cord



**B      \$70**

Blank Plate

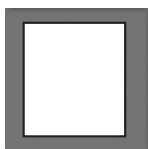

**O      \$70**

Open port for clients own data fitting. Each port selected will be supplied with one set of data adapter kit.

# RETRACTOR FACE-PLATES

## DS-6R

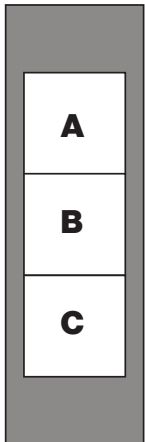

MODEL NUMBER	LIST PRICE
<b>DS-6R</b>	\$100
PLATE ONLY	

### DESCRIPTION

- Extron Retractor faceplate fits 3 Extron retractors. The 6R retractor faceplate can only be placed in position 1 and 4 on the G forum.
- Retractors can be bought through Nienkämper or Users can supply there own Extron retractor components. \*See page 246 for req'd Filler Module.
- Note: This plate holds 3 Extron Retractors. Any spot not using a retractor will require a filler module. If client is suppling there own retractors order filler model #70-1065-35.

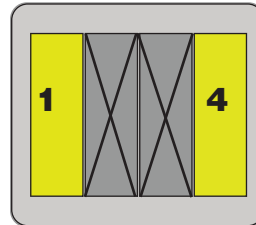

**R-01** **\$1,560**

VGA - Retractor series II - with 36" long cord.



**R-03** **\$1,560**

Data - CAT 6 - retractor series II - with 36" long cord



**R-05** **\$1,560**

USB (signal) - retractor series II - with 36" long cord / USB-A to USB-A



**R-13** **\$1,730**

Display Port - retractor series II - with 36" long cord



**R-15** **\$1,905**

Display Port - retractor series II - with 60" long cord



**R-02** **\$1,560**

3.5mm audio - retractor series II - with 36" long cord



**R-04** **\$1,560**

HDMI - retractor series II - with 36" long cord



**R-06** **\$1,730**

VGA & Audio - retractor series II - with 36" long cord / VGA M-M & 3.5mm audio



**R-14** **\$1,995**

USB-C Pro 8K - retractor series II - with 36" long cord / USB-C to USB-C



**R-16** **\$2,170**

3.5mm audio - retractor series II - with 60" long cord

**R-07** **\$1,730**

VGA - Retractor series II - with 60" long cord.

**R-08** **\$1,730**

3.5mm audio - retractor series II - with 60" long cord

**R-09** **\$1,730**

Data - CAT 6 - retractor series II - with 60" long cord

**R-10** **\$1,730**

HDMI - retractor series II - with 60" long cord

**R-11** **\$1,730**

USB (signal) - retractor series II - with 60" long cord / USB-A to USB-A

**R-12** **\$1,905**

VGA & audio - retractor series II - with 60" long cord / VGA M-M & 3.5mm audio

# SPLIT PLATE

---

## DS-FM



MODEL NUMBER	LIST PRICE
DS-FM	\$190

### DESCRIPTION

- A Filler Module is required if less than 3 Extron retractors are ordered on each Plate 1 & Plate 4.
- A Filler Module is required for clients supplying their own retractors.

# FORUMS

## M & N SERIES FORUM

M & N Series Forum are available in a wide range of configurations for power, data and audio/video requirement. Configure your require M & N Series Forum on our web site at this link [www.nienkämper.com/vfc](http://www.nienkämper.com/vfc)



### SIMPLE POP UP FORUM - Single sided (Surface mounted)

List Price

#### Pre-configured SIMPLE Pop Up Forum

Model # 85190	pre-wired power (2 ports)	<table border="1"><tr><td>1P</td><td>1P</td></tr></table>	1P	1P	\$660		
1P	1P						
		cutout dimension: 5"W x 4"D 2 x pre-wired power with 10ft cord					
Model # 85191	pre-wired power (3 ports)	<table border="1"><tr><td>1P</td><td>1P</td><td>1P</td></tr></table>	1P	1P	1P	\$680	
1P	1P	1P					
		cutout dimension: 6 1/2"W x 4"D 3 x pre-wired power with 10ft cord					
Model # 85193	pre-wired power (3 ports)	<table border="1"><tr><td>1P</td><td>1P</td><td>A5</td></tr></table>	1P	1P	A5	\$810	
1P	1P	A5					
		cutout dimension: 6 1/2"W x 4"D 2 x pre-wired power with 10ft cord 1 x Siemon CAT6 data with 10ft cord					
Model # 85197	pre-wired power (3 ports)	<table border="1"><tr><td>1P</td><td>1P</td><td>O</td></tr></table>	1P	1P	O	\$680	
1P	1P	O					
		cutout dimension: 6 1/2"W x 4"D 2 x pre-wired power with 10ft cord 1 x open port / data adapter to fit in client's own data fitting and cord					
Model # 85194	pre-wired power (3 ports)	<table border="1"><tr><td>1P</td><td>1P</td><td>2U</td></tr></table>	1P	1P	2U	\$775	
1P	1P	2U					
		cutout dimension: 6 1/2"W x 4"D 2 x pre-wired power with 10ft cord 2 x USB-A+C charger (stacked)					
Model # 85196	pre-wired power (4 ports)	<table border="1"><tr><td>1P</td><td>1P</td><td>A5</td><td>A5</td></tr></table>	1P	1P	A5	A5	\$930
1P	1P	A5	A5				
		cutout dimension: 8"W x 4"D 2 x pre-wired power with 10ft cord 2 x Siemon CAT6 data with 10ft cord					
Model # 85198	pre-wired power (4 ports)	<table border="1"><tr><td>1P</td><td>1P</td><td>O</td><td>O</td></tr></table>	1P	1P	O	O	\$710
1P	1P	O	O				
		cutout dimension: 8"W x 4"D 2 x pre-wired power with 10ft cord 2 x open port / data adapter to fit in client's own data fitting and cord					

# FORUMS

## List Price

Model # 85199	pre-wired power (4 ports)	<table border="1"><tr><td>1P</td><td>1P</td><td>2U</td><td>HD</td></tr></table>	1P	1P	2U	HD	\$955		
1P	1P	2U	HD						
		cutout dimension: 8"W x 4"D 2 x pre-wired power with 10ft cord 2 x USB-A+C charger (stacked) 1 x HDMI coupler with 18" cord							
Model # 85200	pre-wired power (4 ports)	<table border="1"><tr><td>1P</td><td>1P</td><td>2U</td><td>O</td></tr></table>	1P	1P	2U	O	\$830		
1P	1P	2U	O						
		cutout dimension: 8"W x 4"D 2 x pre-wired power with 10ft cord 2 x USB-A+C charger (stacked) 1 x open port / data adapter to fit in client's own data fitting and cord							
Model # 85202	pre-wired power (6 ports)	<table border="1"><tr><td>1P</td><td>1P</td><td>2U</td><td>HD</td><td>A5</td><td>A5</td></tr></table>	1P	1P	2U	HD	A5	A5	\$1,290
1P	1P	2U	HD	A5	A5				
		cutout dimension: 11"W x 4"D 2 x pre-wired power with 10ft cord 2 x USB-A+C charger (stacked) 1 x HDMI coupler with 18" cord 2 x Siemon CAT6 data with 10ft cord							
Model # 85203	pre-wired power (6 ports)	<table border="1"><tr><td>1P</td><td>1P</td><td>2U</td><td>HD</td><td>O</td><td>O</td></tr></table>	1P	1P	2U	HD	O	O	\$1,030
1P	1P	2U	HD	O	O				
		cutout dimension: 11"W x 4"D 2 x pre-wired power with 10ft cord 2 x USB-A+C charger (stacked) 1 x HDMI coupler with 18" cord 2 x open port/ data adapter to fit in client's own data fitting and cord							

# FORUMS - SIMPLE POP UP FORUM



## SIMPLE POP UP FORUM – DOUBLE SIDED (SURFACE MOUNTED)

List Price

### Pre-configured SIMPLE Pop Up Forum

Model # 85205 pre-wired power  
(each side - 2 ports)



\$1,335



cutout dimension: 5"W x 7-11/16"D  
Side A: 2 x pre-wired power with 10ft cord  
Side B: 2 x pre-wired power with 10ft cord  
(Provides a total of 4 x pre wired power)

Model # 85206 pre-wired power  
(each side - 3 ports)



\$1,665

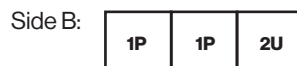

cutout dimension: 6-1/2"W x 7-11/16"D  
Side A: 2 x pre-wired power with 10ft cord  
2 x USB-A+C Charger (stacked)  
Side B: 2 x pre-wired power with 10ft cord  
2 x USB-A+C Charger (stacked)  
(Provides a total of 4 x pre wired power & 4 x USB Charger)

Model # 85208 pre-wired power  
(each side - 4 ports)



\$1,885



cutout dimension: 8"W x 7-11/16"D  
Side A: 2 x pre-wired power with 10ft cord  
2 x Siemon CAT6 data with 10ft cord  
Side B: 2 x pre-wired power with 10ft cord  
2 x Siemon CAT6 data with 10ft cord  
(Provides a total of 4 x pre wired power & 4 x Siemon CAT6 data)

# FORUMS - SIMPLE POP UP FORUM

---

**List Price**

Model # 85209 pre-wired power  
(each side - 4 ports)



cutout dimension: 8"W x 7-11/16"D

Side A: 2 x pre-wired power with 10ft cord

2 x open port/data adapter to fit in client's own data fitting and cord

Side B: 2 x pre-wired power with 10ft cord

2 x open port/data adapter to fit in client's own data fitting and cord

(Provides a total of 4 x pre wired power & 4 x open ports)

\$1,375

Model # 85210 pre-wired power  
(each side - 4 ports)

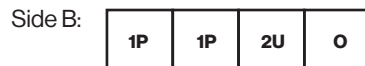

cutout dimension: 8"W x 7-11/16"D

Side A: 2 x pre-wired power with 10ft cord,

2 x USB-A+C Charger (stacked)

1 x open port/ data adapter to fit in client's own data fitting and cord

Side B: 2 x pre-wired power with 10ft cord,

2 x USB-A+C Charger (stacked)

1 x open port/ data adapter to fit in client's own data fitting and cord

(Provides a total of 4 x pre wired power, 4 x USB Charger & 2 x open ports)

\$1,690

---

## FORUMS - SIMPLE POP UP FORUM

---

- Note:
- Finish is standard in clear anodized aluminum.
  - For power cord with 6ft long, please add a letter "B" at the end of model #.
  - Site-wired / hard-wired power with 72" metallic shielded cable is available with an upcharge of \$95 list per 2 power. Please add a letter "H" at the end of model #.
- 

Each open port selected will be supplied with one set of data adapter kit contains 2 "AA", 2 "BB", 2 "CC", 2 "DD", 2 "EE", 2 "FF", 1 "GG" and 1 "HH". adapter. The data adapter can accommodate the following data fitting from manufacturer:

### Adapter "AA"

Systimax/CommScope  
Uniprise/CommScope

### Adapter "BB"

L-Com Keystone Modular  
Tyco SL/110 Connect Series Modular Jacks  
Siemon Keystone Style  
Allen Tel Versa Tap Series  
Leviton Quick Port® Series  
Nordx Keystone Style  
Tyco SL Conpler Series

### Adapter "CC"

Krone 6000 Series/ADC  
Hubbell Xcelerator™ Keystone  
Series

### Adapter "DD"

blank

### Adapter "EE"

Ortronics TracJack Series

### Adapter "FF"

Panduit Mini-Com Series

### Adapter "GG"

microphone jack / 3pin XLR, solder type  
only

### Adapter "HH"

Adapter "HH" - video monitor jack / DB-15,  
panel mount solder type.

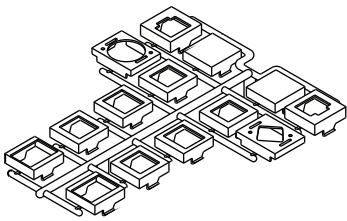

- Snap in fitting adapters are also provide for 3-pin XLR microphone jack (solder type only) and DB-15 video monitor jack (panel mount solder style only)
-

# FORUMS - SIMPLE POP UP FORUM

**List Price**

To create a unique Vox® SIMPLE Pop Up Forum configuration, simply choose a base model and select the required elements.

**Base Model For Simple Pop Up Forum**

(4 Ports)

Model #: CX4P - \_\_\_\_\_

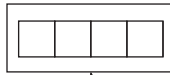

\$575

**Base Model For Simple Pop Up Forum**

(6 Ports)

Model #: CX6P - \_\_\_\_\_

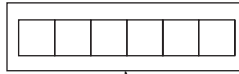

\$650

**Base Model For Simple Pop Up Forum – Double Sided**

(Each Side – 4 Ports)





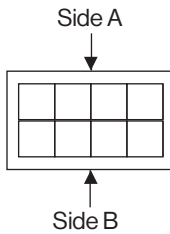







Model #: CX8PD-A \_\_\_\_\_ (Side A)

CX8PD-B \_\_\_\_\_ (Side B)



\$1,210

**Select the elements as per below:**

	S-1P - 1 power receptacle with 10' white cord	\$155
	S-1P-SW - 1 power receptacle hard wired with a 6' whip	\$175
	A5 - SIEMON CAT 6 data fitting with 10' connector cable	\$190
	C - Audio- 3.5mm Mini stereo Jack with 10' cord	\$95
	H - USB port 3.0 with 10ft cord	\$145
	2U - Stacked USB charger A+C	\$180
	3U - Dual USB C charger	\$180
	G - DB15HD, VGA connector, 10' cord	\$205
	HD - HDMI Coupler with 18" cord	\$205
	B - Blank plate	\$70
	O - Open port, for client's own data fitting. Each port selected will be supplied with one set of data adapter kit	\$70
	L - Belay 1" dia. hole opening rubber strain relief pass through cords	\$70

# FORUMS - SIMPLE FORUM

---

## SIMPLE FORUM – SINGLE SIDED (SURFACE MOUNTED)

List Price

---

### Pre-configured SIMPLE Forum (4 ports 6¾” L x 2” W)

Model # 39956/6	pre-wired power	<table border="1"><tr><td>1P</td><td>1P</td><td>A5</td><td>A5</td></tr></table>	1P	1P	A5	A5	\$710
1P	1P	A5	A5				
		2 x pre-wired power with 10ft cord 2 x SIEMON CAT6 data with 10ft cord					
Model # 39957/6	site-wired power	<table border="1"><tr><td>1P-SW</td><td>1P-SW</td><td>A5</td><td>A5</td></tr></table>	1P-SW	1P-SW	A5	A5	\$750
1P-SW	1P-SW	A5	A5				
		2 x site-wired power with 6ft metallic shielded cable 2 x SIEMON CAT6 data with 10ft cord					
Model # 39958/6	pre-wired power	<table border="1"><tr><td>1P</td><td>1P</td><td>2U</td><td>A5</td></tr></table>	1P	1P	2U	A5	\$805
1P	1P	2U	A5				
		2 x pre-wired power with 10ft cord 1 x stacked USB charger A+C 1 x SIEMON CAT6 data with 10ft cord					
Model # 39959/6	site-wired power	<table border="1"><tr><td>1P-SW</td><td>1P-SW</td><td>2U</td><td>A5</td></tr></table>	1P-SW	1P-SW	2U	A5	\$830
1P-SW	1P-SW	2U	A5				
		2 x site-wired power with 6ft metallic shielded cable 1 x stacked USB charger A+C 1 x SIEMON CAT6 data with 10ft cord;					
Model # 39961/6	pre-wired power	<table border="1"><tr><td>1P</td><td>1P</td><td>A5</td><td>HD</td></tr></table>	1P	1P	A5	HD	\$775
1P	1P	A5	HD				
		2 x pre-wired power with 10ft cord 1 x SIEMON CAT6 data with 10ft cord 1 x HDMI coupler with 18” cord					
Model # 39962/6	site-wired power	<table border="1"><tr><td>1P-SW</td><td>1P-SW</td><td>A5</td><td>HD</td></tr></table>	1P-SW	1P-SW	A5	HD	\$805
1P-SW	1P-SW	A5	HD				
		2 x site-wired power with 6ft metallic shielded cable 1 x SIEMON CAT6 data with 10ft cord; 1 x HDMI coupler with 18” cord					

---

## FORUMS - SIMPLE FORUM

---

### SIMPLE FORUM – SINGLE SIDED (SURFACE MOUNTED)

---

List Price

#### Pre-configured SIMPLE Forum (4 ports, 6<sup>3</sup>/<sub>4</sub>" L x 2" W)

Model # 39963	pre-wired power	<table border="1"><tr><td>1P</td><td>1P</td><td>H</td><td>HD</td></tr></table>	1P	1P	H	HD	\$720
1P	1P	H	HD				
		2 x pre-wired power with 10ft cord 1 x USB port 3.0 with 10ft cord 1 x HDMI coupler with 18" cord					
Model # 39964	site-wired power	<table border="1"><tr><td>1P-SW</td><td>1P-SW</td><td>H</td><td>HD</td></tr></table>	1P-SW	1P-SW	H	HD	\$755
1P-SW	1P-SW	H	HD				
		2 x site-wired power with 6ft metallic shielded cable 1 x USB port 3.0 with 10ft cord 1 x HDMI coupler with 18" cord					

# FORUMS - SIMPLE FORUM

## SIMPLE FORUM – SINGLE SIDED (SURFACE MOUNTED)

List Price

### Pre-configured SIMPLE Forum (4 ports, for client's own data fitting)

Model # 39956	pre-wired power	<table border="1"> <tr> <td>1P</td> <td>1P</td> <td>0</td> <td>0</td> </tr> </table>	1P	1P	0	0	\$550
1P	1P	0	0				
		<p>2 x pre-wired power with 10ft cord 2 x open port / data adapter to fit in client's own data fitting &amp; cord</p>					
Model # 39957	site-wired power	<table border="1"> <tr> <td>1P-SW</td> <td>1P-SW</td> <td>0</td> <td>0</td> </tr> </table>	1P-SW	1P-SW	0	0	\$575
1P-SW	1P-SW	0	0				
		<p>2 x site-wired power with 6ft metallic shielded cable 2 x open port / data adapter to fit in client's own data fitting &amp; cord</p>					
Model # 39958	pre-wired power	<table border="1"> <tr> <td>1P</td> <td>1P</td> <td>2U</td> <td>0</td> </tr> </table>	1P	1P	2U	0	\$680
1P	1P	2U	0				
		<p>2 x pre-wired power with 10ft cord 1 x stacked USB charger A+C 1 x open port</p>					
Model # 39959	site-wired power	<table border="1"> <tr> <td>1P-SW</td> <td>1P-SW</td> <td>2U</td> <td>0</td> </tr> </table>	1P-SW	1P-SW	2U	0	\$710
1P-SW	1P-SW	2U	0				
		<p>2 x site-wired power with 6ft metallic shielded cable 1 x stacked USB charger A+C 1 x open port</p>					
Model # 39961	pre-wired power	<table border="1"> <tr> <td>1P</td> <td>1P</td> <td>0</td> <td>HD</td> </tr> </table>	1P	1P	0	HD	\$720
1P	1P	0	HD				
		<p>2 x pre-wired power with 10ft cord 1 x open port 1 x HDMI coupler with 18" cord</p>					
Model # 39962	site-wired power	<table border="1"> <tr> <td>1P-SW</td> <td>1P-SW</td> <td>0</td> <td>HD</td> </tr> </table>	1P-SW	1P-SW	0	HD	\$755
1P-SW	1P-SW	0	HD				
		<p>2 x site-wired power with 6ft metallic shielded cable 1 x open port 1 x HDMI coupler with 18" cord</p>					

# FORUMS - SIMPLE FORUM

---

## SIMPLE FORUM – SINGLE SIDED (SURFACE MOUNTED)

---

List Price

### Pre-configured SIMPLE Forum (6 ports 9<sup>3</sup>/<sub>4</sub>" L x 2" W)

Model # 39941/6	pre-wired power	<table border="1"><tr><td>1P</td><td>1P</td><td>A5</td><td>A5</td><td>B</td><td>B</td></tr></table> <p>2 x pre-wired power with 10ft cord 2 x SIEMON CAT6 data with 10ft cord 2 x blank plate</p>	1P	1P	A5	A5	B	B	\$855
1P	1P	A5	A5	B	B				
Model # 39942/6	site-wired power	<table border="1"><tr><td>1P-SW</td><td>1P-SW</td><td>A5</td><td>A5</td><td>B</td><td>B</td></tr></table> <p>2 x site-wired power with 6ft metallic shielded cable 2 x SIEMON CAT6 data with 10ft cord 2 x blank plate</p>	1P-SW	1P-SW	A5	A5	B	B	\$925
1P-SW	1P-SW	A5	A5	B	B				
Model # 39943/6	pre-wired power	<table border="1"><tr><td>1P</td><td>1P</td><td>A5</td><td>A5</td><td>G</td><td>C</td></tr></table> <p>2 x pre-wired power with 10ft cord 2 x SIEMON CAT6 data with 10ft cord 1 x HD-DB15/VGA connector with 10ft cord 1 x audio 3.5mm mini stereo jack with 10 ft cord</p>	1P	1P	A5	A5	G	C	\$1,035
1P	1P	A5	A5	G	C				
Model # 39944/6	site-wired power	<table border="1"><tr><td>1P-SW</td><td>1P-SW</td><td>A5</td><td>A5</td><td>G</td><td>C</td></tr></table> <p>2 x site-wired power with 6ft metallic shielded cable 2 x SIEMON CAT6 data with 10ft cord 1 x HD-DB15/VGA connector with 10ft cord 1 x audio 3.5mm mini stereo jack with 10ft cord</p>	1P-SW	1P-SW	A5	A5	G	C	\$1,115
1P-SW	1P-SW	A5	A5	G	C				

---

# FORUMS - SIMPLE FORUM

---

## SIMPLE FORUM – SINGLE SIDED (SURFACE MOUNTED)

List Price

---

### Pre-configured SIMPLE Forum (6 ports 9<sup>3</sup>/<sub>4</sub>" L x 2" W)

Model # 39945/6	pre-wired power	<table border="1"><tr><td>1P</td><td>1P</td><td>A5</td><td>A5</td><td>HD</td><td>H</td></tr></table> <p>2 x pre-wired power with 10ft cord 2 x SIEMON CAT6 data with 10ft cord 1 x HDMI coupler with 18" cord 1 x USB port 3.0 with 10ft cord</p>	1P	1P	A5	A5	HD	H	\$1,065
1P	1P	A5	A5	HD	H				
Model # 39946/6	site-wired power	<table border="1"><tr><td>1P-SW</td><td>1P-SW</td><td>A5</td><td>A5</td><td>HD</td><td>H</td></tr></table> <p>2 x site-wired power with 6ft metallic shielded cable 2 x SIEMON CAT6 data with 10ft cord; 1 x HDMI coupler with 18" cord 1 x USB port 3.0 with 10ft cord</p>	1P-SW	1P-SW	A5	A5	HD	H	\$1,135
1P-SW	1P-SW	A5	A5	HD	H				
Model # 39947/6	pre-wired power	<table border="1"><tr><td>1P</td><td>1P</td><td>1P</td><td>A5</td><td>A5</td><td>A5</td></tr></table> <p>3 x pre-wired power with 10ft cord 3 x SIEMON CAT6 data with 10ft cord</p>	1P	1P	1P	A5	A5	A5	\$1,015
1P	1P	1P	A5	A5	A5				
Model # 39948/6	site-wired power	<table border="1"><tr><td>1P-SW</td><td>1P-SW</td><td>1P-SW</td><td>A5</td><td>A5</td><td>A5</td></tr></table> <p>3 x site-wired power with 6ft metallic shielded cable 3 x SIEMON CAT6 data with 10ft cord</p>	1P-SW	1P-SW	1P-SW	A5	A5	A5	\$1,080
1P-SW	1P-SW	1P-SW	A5	A5	A5				

---

# FORUMS - SIMPLE FORUM

## SIMPLE FORUM – SINGLE SIDED (SURFACE MOUNTED)

List Price

### Pre-configured SIMPLE Forum (6 ports, for client's own data fitting)

Model # 39951	pre-wired power	<table border="1" style="border-collapse: collapse; width: 100%;"> <tr> <td style="padding: 2px 10px;">1P</td> <td style="padding: 2px 10px;">1P</td> <td style="padding: 2px 10px;">O</td> <td style="padding: 2px 10px;">O</td> <td style="padding: 2px 10px;">O</td> <td style="padding: 2px 10px;">O</td> </tr> </table>	1P	1P	O	O	O	O	\$625
1P	1P	O	O	O	O				
		<p>2 x pre-wired power with 10ft cord 4 x open port/data adapter to fit in client's own data fitting and cord</p>							
Model # 39952	site-wired power	<table border="1" style="border-collapse: collapse; width: 100%;"> <tr> <td style="padding: 2px 10px;">1P-SW</td> <td style="padding: 2px 10px;">1P-SW</td> <td style="padding: 2px 10px;">O</td> <td style="padding: 2px 10px;">O</td> <td style="padding: 2px 10px;">O</td> <td style="padding: 2px 10px;">O</td> </tr> </table>	1P-SW	1P-SW	O	O	O	O	\$660
1P-SW	1P-SW	O	O	O	O				
		<p>2 x site-wired power with 6ft metallic shielded cable 4 x open port/data adapter to fit in client's own data fitting and cord</p>							
Model # 39953	pre-wired power	<table border="1" style="border-collapse: collapse; width: 100%;"> <tr> <td style="padding: 2px 10px;">1P</td> <td style="padding: 2px 10px;">1P</td> <td style="padding: 2px 10px;">1P</td> <td style="padding: 2px 10px;">O</td> <td style="padding: 2px 10px;">O</td> <td style="padding: 2px 10px;">O</td> </tr> </table>	1P	1P	1P	O	O	O	\$650
1P	1P	1P	O	O	O				
		<p>3 x pre-wired power with 10ft cord 3 x open port/data adapter to fit in client's own data fitting and cord</p>							
Model # 39954	site-wired power	<table border="1" style="border-collapse: collapse; width: 100%;"> <tr> <td style="padding: 2px 10px;">1P-SW</td> <td style="padding: 2px 10px;">1P-SW</td> <td style="padding: 2px 10px;">1P-SW</td> <td style="padding: 2px 10px;">O</td> <td style="padding: 2px 10px;">O</td> <td style="padding: 2px 10px;">O</td> </tr> </table>	1P-SW	1P-SW	1P-SW	O	O	O	\$695
1P-SW	1P-SW	1P-SW	O	O	O				
		<p>3 x site-wired power with 6ft metallic shielded cable 3 x open port/data adapter to fit in client's own data fitting and cord</p>							

Each open port selected will be supplied with one set of data adapter kit contains 2 "AA", 2 "BB", 2 "CC", 2 "DD", 2 "EE", 2 "FF", 1 "GG" and 1 "HH". adapter. The data adapter can accommodate the following data fitting from manufacturer:

#### Adapter "AA"

Systemax/CommScope  
Uniprise/CommScope

#### Adapter "BB"

L-Com Keystone Modular  
Tyco SL/110 Connect Series Modular Jacks  
Simon Keystone Style  
Allen Tel Versa Tap Series  
Leviton Quick Port® Series  
Nordx Keystone Style  
Tyco SL Conpler Series

#### Adapter "CC"

Krone 6000 Series/ADC  
Hubbell Xcelerator™ Keystone Series

#### Adapter "DD"

blank

#### Adapter "EE"

Ortronics TracJack Series

#### Adapter "FF"

Panduit Mini-Com Series

#### Adapter "GG"

microphone jack / 3pin XLR, solder type only

#### Adapter "HH"

Adapter "HH" - video monitor jack / DB-15, panel mount solder type.

# FORUMS - SIMPLE FORUM

---

## CUSTOM SIMPLE FORUM

### LIST PRICE

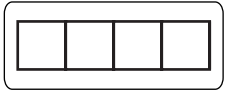

\$350













CX4- \_\_\_\_\_



\$375

CX6- \_\_\_\_\_

### Select the elements as per below:

	S-1P - 1 power receptacle with 10' white cord	\$155
	S-1P-SW - 1 power receptacle hard wired with a 6' whip	\$175
	A5 - SIEMON CAT 6 data fitting with 10' connector cable	\$190
	C - Audio- 3.5mm Mini stereo Jack with 10' cord	\$95
	H - USB port 3.0 with 10ft cord	\$145
	2U - Stacked USB charger A+C	\$180
	3U - Dual USB C charger	\$180
	G - DB15HD, VGA connector, 10' cord	\$205
	HD - HDMI Coupler with 18" cord	\$205
	B - Blank plate	\$70
	O - Open port, for client's own data fitting. Each port selected will be supplied with one set of data adapter kit	\$70
	L - Belay 1" dia. hole opening rubber strain relief pass through cords	\$70

---