

nienkämper

SEATING & MEETING PODS

PRICE LIST



2026

TABLE OF CONTENTS

How to Order Nienkämper Seating	4
Upholstery Details	6-11
Nienkämper Leather	5
Customer's Own Material (COM)	6
KnollTextiles	6
Customer's Own Leather (COL)	6
Shipping Your Materials	6
Knoll Textiles Categories and Index	7-8
California Technical Bulletin 133	9
Veneers / Finishes	10
Office Seating	11-23
AYA™	13
Emissary	14
HSC Task	15
Nienkämper NOW®	16-17
Senator® Boardroom	18
Senator® CEO	19
Senator® Executive	20
Senator Mesh Back	21
Slim	22
Trench	23
Side Chairs	24-28
HSC	26
Kush	27
Senator® Nuvo Sled Base	28
Lounge Seating	29-83
Bare	31
BASS Collection	32-33
Bay	34
Beam	35-36
Berkley® Collection	37-42
Blob	43
Carlisle	44
Dobi	45
Dune	46
Elite	47
Gateway™ Lounge	48-53
Godbout	54
Heartbeat	55-56
Isola 8	57
J + J Studio	58

Kloud® Collection	59
Kloud® Serpentine™	60
Leaf	61
Nordic	62
Note	63
Radius	64-65
Rowan	66
Satori™	67
Six® Collection	68
Turnaround® Collection	69
Tuxedo™	70-71
Tuxedo™ Classic	72-75
Tuxedo™ Cove	76-79
Tuxedo™ High Back	80-81
Wavelength®	82-83
Stools and Benches	84-95
Blottoman™	86
Caravite	87
Jackal	88
Kloud® Benches	89
Mint	90
Moment Collection	91
Six Collection® Benches	92
Spin Stool/Tables	93
Wavelength® Benches	94
Zoo Stools	95
Meeting Pods	96-98
Patkau Ice Hut	97
TOKO Meeting Pod	98

HOW TO ORDER NIENKÄMPER SEATING

SELECT THE CHAIR:

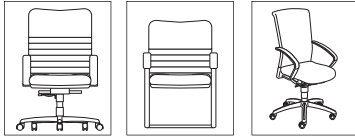

Select the style of chair that best suits your needs. All features are listed on each page.

Sample:

Standard Features:

- Pneumatic height adjustment
- Back tilt locking mechanism
- Tension control
- Carpet casters
- Black five-star base

Optional Features:

- Hard floor casters, Black, add \$85 list per chair
- Hard floor casters, Chrome, add \$100 list per chair
- Glides with self return base & pneumatic height adjustment, add \$105 list per chair
- Polished aluminum five-star base, add \$205 list
- Chrome finish sled base, add \$190 list

SELECT YOUR ARM TYPE:



For each style of chair there are a number of arm options. These are listed under the model number with an extension. For example 1411_ is the model number for the Senator Executive low back chair. Extension #1 specifies Urethane Arm, extension #3 specifies Urethane arm with cap & wrap, and so on.

Sample:

1411_

18½"-21½" 25" 25" 26" 36"

(Model #1) Urethane arm

fabric 1¾ Yds. leather 32 Sq. Ft.

(Model #2) Urethane arm with cap

fabric 2 Yds. leather 35 Sq. Ft.

(Model #3) Urethane arm with cap & wrap

fabric 2¼ Yds. leather 37 Sq. Ft.

SELECT YOUR BASE:



At the end of each chair listing are notes indicating base options and finishes, where applicable. Review these notes and specify your base type and finish at the time you place your order.

Cross Section Example:

Standard Features:

- Pneumatic height adjustment
- Back tilt locking mechanism
- Tension control
- Carpet casters
- Black five-star base

Optional Features:

- Hard floor casters, Black, add \$85 list per chair
- Hard floor casters, Chrome, add \$100 list per chair
- Glides with self return base & pneumatic height adjustment, add \$105 list per chair
- Polished aluminum five-star base, add \$205 list
- Chrome finish sled base, add \$190 list

SELECT YOUR OPTIONS:

Each chair has additional options to choose from, listed on each page.

Optional Features:

- Hard floor casters, Black, add \$85 list per chair
- Hard floor casters, Chrome, add \$100 list per chair
- Glides with self return base & pneumatic height adjustment, add \$105 list per chair
- Polished aluminum five-star base, add \$205 list
- Chrome finish sled base, add \$190 list

SELECT YOUR FABRIC:

For each chair we have priced COM, COL, Nienkämper's three grades of leather and four grades of KnollTextiles. Refer to the row that corresponds to the chair you are ordering.

For information on COM and COL please refer to page 6.

UPHOLSTERY DETAILS

NIENKÄMPER LEATHER:

Nienkämper is universally known for its exquisite craftsmanship in leather furniture. Nienkämper leather on Nienkämper furniture offers you and your clients the highest quality of materials as well as favorable pricing. Our Verde and Grano leather is available as COL sold to the nearest half hide. Ecopell leather is available for Nienkämper furniture only.

The Verde Collection:

Available in 8 colors this collection provides a varied selection of neutrals, browns, reds and blues. It is organically tanned using a chrome-free process with a water-based semi-aniline finish. These improved techniques result in a more natural character, combined with a softer touch and brighter colors that are consistent from batch to batch.

Raw Material: Scandinavian Cow Hide

Thickness: 1.1-1.3 mm

Type: Chrome-free tanned with a water-based semi-aniline finish. Full natural grain, excellent durability yet soft and pliable, suitable for public environments. Some visible healed scars add natural character to this leather.

Average Hide Size: 55 sq.ft.

The Grano Collection:

The perfect balance between strength and softness. Semi-aniline Grano has exceptional natural beauty and pliancy. An easy-to-clean finish makes this leather appropriate for seating in reception areas, meeting rooms and managerial offices.

Raw Material: European Cow Hide

Thickness: 1.2-1.4 mm

Type: Semi-aniline dyed.

Average Hide Size: 55 sq.ft.

The Neather Collection:

Available in 6 colors, Neather is a synthetic material similar to vinyl . It comes in a standard 54" width. Neather is easy to clean and a good option for accessory or upholstery items.

To request leather samples please contact your local sales representative, for a listing or call Nienkämper Customer Service at 800.668.9318.

UPHOLSTERY DETAILS

CUSTOMER'S OWN MATERIALS (COM):

Nienkämper reserves the right to determine the suitability of a particular COM on our furniture. If we determine, in our judgment, that the COM is inappropriate for use on a particular product we will notify the customer. If you have any questions on the appropriateness of your COM please submit a sample to Customer Service prior to your order.

KNOLLTEXTILES:

All Nienkämper seating available in fabric includes pricing for four grades of fabric, see the KnollTextiles grade columns throughout this book. All fabric orders should be made when ordering the furniture. For KnollTextiles samples contact the KnollTextiles Customer Service department at 1.866.565.5858.

All yardage requirements are noted for each model number and option, refer to the pricing charts in this book. All yardage requirements shown in our price list are based on 54" plain material. Fabrics which have a repeat that must be matched, or are less than 54" wide, will require more yardage. Check with Customer Service before ordering. There may be yardage savings for quantity orders of the same model. Check with Customer Service before ordering. ALL COM WILL BE CUT AND APPLIED AT OUR DISCRETION UNLESS SPECIAL CUTTING INSTRUCTIONS ARE INCLUDED IN WRITING WITH THE ORDER. FABRIC PATTERNS SHOULD BE IDENTIFIED AS APPLIED VERTICALLY OR HORIZONTALLY ON A FRAME. WE CANNOT BE HELD RESPONSIBLE FOR RECEIPT OF DEFECTIVE FABRIC AS WE APPLY ALL COM AS FIRST QUALITY GOODS.

Fabric	Plain	2" - 14"	15" - 24"	25" - 27"	28" - 36"
Width	Fabric	Repeat	Repeat	Repeat	Repeat
54"	0%	10%	15%	20%	25%
50"	10%	20%	25%	30%	35%
48"	15%	25%	30%	35%	40%
45"	40%	50%	55%	60%	65%
36"	50%	60%	65%	70%	75%

We cannot be held responsible if yardage supplied is insufficient to complete an order.

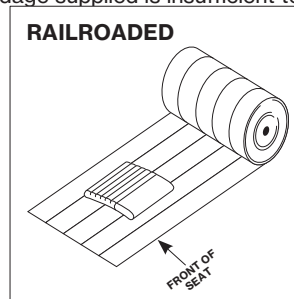
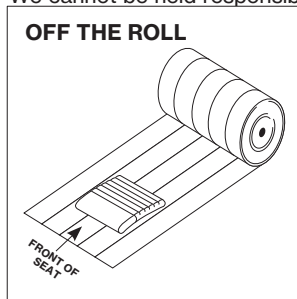

CUSTOMER'S OWN LEATHER:

All furniture listed in this price list that is available with leather has pricing in COL, refer to the COL column throughout this book. Leather is applied to avoid scars, however, some markings are inherent in this natural material. Square footage requirements are based on cow hides measuring 50 sq.ft. per hide. Consult Nienkämper's Customer Service Department for square footage requirements before ordering when using hides that do not meet these requirements. Application instructions must accompany all COL orders. In the absence of these instructions Nienkämper will determine the best method of upholstery.

SHIPPING YOUR MATERIALS:

For Canada
Customer supplied material must be sent prepaid to:

Nienkämper International, Inc.
257 Finchdene Square
Toronto, Ontario
Canada M1X 1B9

From all locations outside of Canada
Customer supplied material must be sent prepaid to:

Willson International Limited
c/o Nienkämper
257 Finchdene Square
Toronto, Ontario
Canada M1X 1B9

All packages must include a copy of a commercial invoice showing the exact yardage, value and fibre content of the fabric and must indicate our order confirmation number, or customer's purchase order number, and the furniture for which it is intended.

UPHOLSTERY DETAILS

An index of KnollTextiles fabric follows. Contact KnollTextiles customer service at 1.800.237.1625 for an updated listing. For fabric not graded in, please contact customer service for pricing.

ALPHABETICAL INDEX:

Category 1	
Fabric Name	Pattern #
Attire	466933
Boundary*	466735
Brigadoon*	466914
Chameleon*	466929
Commuter Cloth	466879
Contour*	466950
Cozy Cord*	466938
Crossroad	466672
Delite	466730
Diva	466722
Dottie	466799
Facet*	466804
Ferry	466850
Hourglass	466846
Infinite	466734
Instinct	466921
Journey	466866
Keaton	466851
Knoll Hopsack	466729
Little Devil	466916
Oh La La	466671
Olympia	466808
Plaid On*	466947
Prairie*	466762
Puff	466726
Shadow Play*	466759
Sonnet	466909
Summit	466694
Tinge*	466721
Topos*	466800
Utopia*	466867
Vast*	466945
Venue	466756
Vibe II*	466718
Westwood*	466757
Wild Thing*	466779
Winnow*	466960

Category 2	
Fabric Name	Pattern #
Atlas*	466702
Aurora, 1985	466954
Buzz	466719
Caliper*	466804
Circle Point*	466942
Cleo	466910
Code	466736
Color Field*	466712
Currents*	466951
Dactyl*	466673
Day Tripper	466913
Durand*	466895
Entwine	466937
Flower Power	466946
Greenwich*	466878
Homage*	466943
Hummingbird	466956
Island*	466765
Kiln*	466965
Knoll Felt	466830
Off the Grid	466725
Palisade*	466763
Pathway*	466941
Pico	466968
Placid*	466949
Premier*	466920
Prestini*	466953
Pullman	466917
Rebel	466922
Retreat*	466944
Seurat	466811
Smart*	466853
Tempest	466724
Utmost II	466931
Vice Versa*	466925
Whip*	466842
Woodland II*	466723
Wow Factor	466720

Category 3	
Fabric Name	Pattern #
Aegean	466769
Alter Ego	466792
Arrondissement	466711
Biscayne	466890
Cameo	466674
Circa	466753
Classic Boucle	466777
Color Collage	466716
Eclat Weave	466773
Fancy Twill	466717
Imprint	466923
In Stitches	466908
It's Complicated*	466771
Looped In	466948
Mococco, 1966	466967
Modern Tweed	466795
Nature Walk*	466770
Rivers	466806
Sherman	466841
Texnet*	466760
Vert	466955

Category 4	
Fabric Name	Pattern #
Altiplano	466974
Amore	466905
Arezzo	466776
Atelier	466882
Catwalk	466907
Chiseled	466919
Dapper	466803
Firefly	466901
Floressence	466924
In Step	466928
Rivington	466939
Stretch Appeal	466871
Striae Stripe	466930
Stripe It*	466683
Tara	466926
Ultrasuede	466793
Utrillo	466945

Not Graded In	
Fabric Name	Pattern #
Byron	466710
Cato	466862
Chic	466934
Cummings	466709
Digi Velvet	466816
Daily	466807
Dynamic	466845
Guisse	466727
Ita	466693
Knoll Velvet	466780
Limani	466906
Lowell	466707
North Island	466704
Sandis	466915

NOTE: Fabric with "*" is Bleach Cleanable with diluted household bleach.

FABRIC DETAILS

An index of KnollTextiles follows. Contact KnollTextiles customer service at 1.800.237.1625 for an updated listing. For fabric not graded in, please contact customer service for pricing.

NUMERICAL INDEX:

Category 1	
Fabric Name	Pattern #
Oh La La	466671
Crossroad	466672
Summit	466694
Vibe II*	466718
Tinge*	466721
Diva	466722
Puff	466726
Knoll Hopsack	466729
Delite	466730
Infinite	466734
Boundary*	466735
Venue	466756
Westwood*	466757
Shadow Play*	466759
Prairie*	466762
Wild Thing*	466779
Dottie	466799
Topos*	466800
Facet*	466804
Olympia	466808
Hourglass	466846
Ferry	466850
Keaton	466851
Journey	466866
Utopia*	466867
Commuter Cloth	466879
Sonnet	466909
Brigadoon*	466914
Little Devil	466916
Instinct	466921
Chameleon*	466929
Attire	466933
Cozy Cord*	466938
Vast*	466945
Plaid On*	466947
Contour*	466950
Winnow*	466960

Category 2	
Fabric Name	Pattern #
Dactyl*	466673
Atlas*	466702
Color Field*	466712
Buzz	466719
Wow Factor	466720
Woodland II*	466723
Tempest	466724
Off the Grid	466725
Code	466736
Palisade*	466763
Island*	466765
Caliper*	466804
Seurat	466811
Knoll Felt	466830
Whip*	466842
Smart*	466853
Greenwich*	466878
Durand*	466895
Cleo	466910
Day Tripper	466913
Pullman	466917
Premier*	466920
Rebel	466922
Vice Versa*	466925
Utmost II	466931
Entwine	466937
Pathway*	466941
Circle Point*	466942
Homage*	466943
Retreat*	466944
Flower Power	466946
Placid*	466949
Currents*	466951
Prestini*	466953
Aurora, 1985	466954
Hummingbird	466956
Kiln*	466965
Pico	466968

Category 3	
Fabric Name	Pattern #
Cameo	466674
Arrondissement	466711
Color Collage	466716
Fancy Twill	466717
Circa	466753
Texnet*	466760
Aegean	466769
Nature Walk*	466770
It's Complicated*	466771
Eclat Weave	466773
Classic Boucle	466777
Alter Ego	466792
Modern Tweed	466795
Rivers	466806
Sherman	466841
Biscayne	466890
In Stitches	466908
Imprint	466923
Looped In	466948
Vert	466955
Mococco, 1966	466967

Category 4	
Fabric Name	Pattern #
Stripe It*	466683
Arezzo	466776
Ultrasuede	466793
Dapper	466803
Stretch Appeal	466871
Atelier	466882
Firefly	466901
Amore	466905
Catwalk	466907
Chiseled	466919
Florescence	466924
Tara	466926
In Step	466928
Striae Stripe	466930
Rivington	466939
Utrillo	466945
Altiplano	466974

Not Graded In	
Fabric Name	Pattern #
Ita	466693
North Island	466704
Lowell LUXE	466707
Cummings	466709
Byron	466710
Guise	466727
Knoll Velvet	466780
Doily	466807
Digi Velvet	466816
Dynamic	466845
Cato	466862
Limani	466906
Sandis	466915
Chic	466934

NOTE: Fabric with "*" is Bleach Cleanable with diluted household bleach.

CALIFORNIA TECHNICAL BULLETIN 133

All chairs utilize California Bulletin 117 approved fire retardant, CFC-free polyurethane foam.

California 133 - Nienkämper seating designs can be manufactured to meet California Technical Bulletin 133. Certification applies to Nienkämper leathers and fabrics that have a minimum 50% natural fibre content. COM/COL's must be evaluated on an individual basis which may require testing of fabric on the furniture. Testing may require additional cost and lead time.

-Cost of testing a chair is \$950 NET, plus cost of product.

-Additional lead time for testing is 6 weeks.

-See individual product pages for seating that has been tested, applicable upcharge for CAL 133 stated on product page.

Boston Fire Code - Boston has adopted California 133 standards. All information pertaining to California Technical Bulletin 133 as stated above satisfies the Boston Fire Code.

CAL 133 Available	Page
Office Seating:	
Nienkämper NOW®	19-25
Senator® Boardroom	26
Senator® CEO	27
Senator® Executive	28
Lounge Seating:	
Berkley® Collection.....	45-50
Blob™	51
Carlisle.....	52
Kloud Collection	61
Satori™	69
Six® Collection	70
Tuxedo™	72-73
Tuxedo™ Classic	74-77
Tuxedo™ High Back.....	82-83
Wavelength®	84-85
Benches:	
Blottoman	88
Six® Bench	94
Wavelength® Bench	96

Note: Add the extension “-CAL” at the end of each model number for each chair ordered as CAL 133 certified. For example, a Senator Executive, low back chair on casters with urethane arm, CAL 133 certified would be Model # 14111-CAL.

VENEERS

All wood surfaces are protected with a durable polyurethane clear lacquer with UV inhibitor. This finish is known for its exceptional durability, as well as abrasion, chemical, impact and scratch resistance. Standard sheen level is 45 degrees. Optional matte, 5, 10 and 35 degree sheen levels are available on request at no additional cost.

Wood Species	Order Code	Veneer/Stain	Upcharge
Maple	F-01	Natural Maple	No upcharge applies.
	F-02	Natural Curly Maple - Rotary Cut	Add 15%.
	F-03	Natural Bird's Eye Maple - Rotary Cut	Call Customer Service for pricing.
	F-04	Maple Stained Pear	No upcharge applies.
Cherry	F-05	Natural Cherry	No upcharge applies.
	F-06	Standard Cherry	No upcharge applies.
	F-07	Cherry Stained Amber	No upcharge applies.
	F-08	Cherry Stained Auburn	No upcharge applies.
	F-09	Cherry Stained Burgundy	No upcharge applies.
Mahogany	F-10	Light Mahogany	No upcharge applies.
	F-11	Medium Mahogany	No upcharge applies.
	F-12	Dark Mahogany	No upcharge applies.
	F-13	Red Mahogany	No upcharge applies.
Anagre	F-14	Natural Figured Anagre - Qtr. Cut Book-Match	Add 15%.
	F-15	Figured Anagre Stained Amber - Qtr. Cut Book-Match	Add 15%.
Sycamore	F-16	Natural Figured Sycamore - Qtr. Cut Book-Match	Add 15%.
Walnut	F-17	Burnt Walnut	No upcharge applies.
	F-19	Natural Walnut- Flat Cut Book-Match	No upcharge applies.
	F-19FM	Natural Walnut- Flat Cut Book-Match (matte sheen)	No upcharge applies.
	F-27F	Creamy Walnut- Flat Cut Book-Match (10° sheen)	No upcharge applies.
	F-27R	Creamy Walnut - Rift Cut Slip-Match (10° sheen)	Add 5%
	F-28	Tawny Walnut	No upcharge applies.
	F-31FM	Autumn Walnut- Flat Cut Book-Match (matte sheen)	No upcharge applies.
	F-31RM	Autumn Walnut - Rift Cut Slip-Match (matte sheen)	Add 5%
Oak	F-18F	Natural White Oak - Flat Cut Book-Match (10° sheen)	No upcharge applies.
	F-18R	Natural White Oak - Rift Cut Slip-Match (10° sheen)	Add 5%
	F-26	Charcoal Ash On Oak- Flat Cut Book- Match (10° sheen)	No upcharge applies.
	F-29F	Smoky Oak - Flat Cut Book-Match	No upcharge applies.
	F-29R	Smoky Oak - Rift Cut Slip-Match	Add 5%
	F-29FM	Smoky Oak - Flat Cut Book-Match (matte sheen)	No upcharge applies.
	F-29RM	Smoky Oak - Rift Cut Slip-Match (matte sheen)	Add 5%
	F-30FM	Whisper White Oak - Flat Cut Book-Match (matte sheen)	No upcharge applies.
	F-30RM	Whisper White Oak - Rift Cut Slip-Match (matte sheen)	Add 5%
	F-32FM	Cotton White Oak - Flat Cut Book-Match (matte sheen)	No upcharge applies.
F-32RM	Cotton White Oak - Rift Cut Slip-Match (matte sheen)	Add 5%	
Sapele – Ribbon Stripe	F-20	Natural Ribbon Strip Sapele - Qtr. Cut Slip-Match	No upcharge applies.
Moabi (Cherry substitute)	F-21	Natural Moabi - Quarter - Qtr. Cut Book-Match	No upcharge applies.
Cape Coast Walnut	F-22	Dark Cape Coast Walnut - Qtr. Cut Slip-Match	No upcharge applies.
	F-23	Natural Cape Coast Walnut - Qtr. Cut Slip-Match	No upcharge applies.
	F-23	Natural Cape Coast Walnut - Qtr. Cut Slip-Match	No upcharge applies.
Ash	F-25	Slate Gray Ash - Qtr. Cut Slip-Match	No upcharge applies.

VENEER GRAIN OPTIONS

Nienkämper products utilize the best quality veneers available, and, combined with Nienkämper's patented veneering systems, create work environments of incredible quality and beauty.

All veneer furniture comes standard with flat cut book-match veneer; flat cut slip-match veneer can also be specified. Quarter cut slip-match and quarter cut book-match veneers are available at a 5% upcharge. Figured Anagre and Figured Sycamore veneers are Quarter cut book-matched. Bird's Eye Maple and Curly Maple are rotary cut. Facet Edge, Taper edge, Flowform, Camber and Self edge tops with veneer are manufactured with a solid wood edge. All edges are then veneer wrapped to create a seamless profile top.

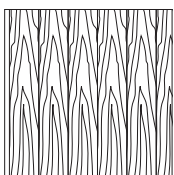

Standard V1
Flat Cut Book-Match

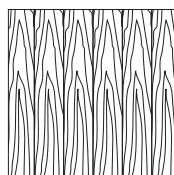

Flat Cut Slip-Match V2

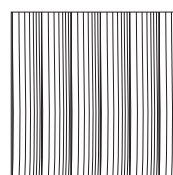

Quarter Cut Slip-Match V3
Add 5%

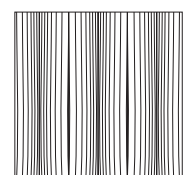

Quarter Cut Book-Match V4
Add 5%

nienkämper

SEATING & MEETING PODS

OFFICE SEATING



2026

OFFICE SEATING

TABLE OF CONTENTS

Office Seating	11-23
AYA™	13
Emissary	14
HSC Task Chair	15
Nienkämper NOW®	16-17
Senator® Boardroom	18
Senator® CEO	19
Senator® Executive	20
Senator® Mesh Back	21
Slim	22
Trench	23

OFFICE SEATING

AYA™ Designer - Mark Saffell and David Ritch

– US Only –

Model Number	Seat H"	Arm		D"	H"	Fabric Yds.	Leather Sq. Ft.	COM	COL	Verde	Grano	Cremoso	Knoll Textiles			
		H"	W"										1	2	3	4

MEDIUM BACK

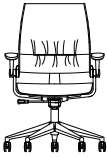

13301 Black Base	18- 21	24-27	26½	26	36-39	1¼	28	2,580	2,710	3,430	3,705	3,805	2,785	2,920	3,090	3,245
13302 Polished Aluminum with Black Casters	18- 21	24-27	26½	26	36-39	1¼	28	2,715	2,855	3,580	3,845	3,935	2,920	3,060	3,225	3,385
13305 Polished Aluminum with Chrome Casters	18- 21	24-27	26½	26	36-39	1¼	28	2,745	2,880	3,605	3,870	3,960	2,950	3,085	3,250	3,410

HIGH BACK

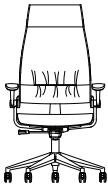

13303 Black Base	18- 21	24-27	26½	26	45-48	2	34	3,245	3,400	4,285	4,615	4,720	3,480	3,635	3,825	4,010
13304 Polished Aluminum with Black Casters	18- 21	24-27	26½	26	45-48	2	34	3,390	3,530	4,435	4,770	4,865	3,620	3,775	3,965	4,150
13306 Polished Aluminum with Chrome Casters	18- 21	24-27	26½	26	45-48	2	34	3,410	3,580	4,460	4,790	4,900	3,640	3,800	3,985	4,170

The ultimate in ergonomic elegance, the AYA™ Chair is based on the principles of natural body motion when reclining. The simplicity of function uses the occupant's own weight to control the seating position. As you recline and stop, the chair will stay in that position. There is no tension control, as the weight of the occupant rides up a ten degree incline, using gravity as the resistance and friction as the position control. There is only one control on the chair which adjusts height and locks the seat in one of five positions.

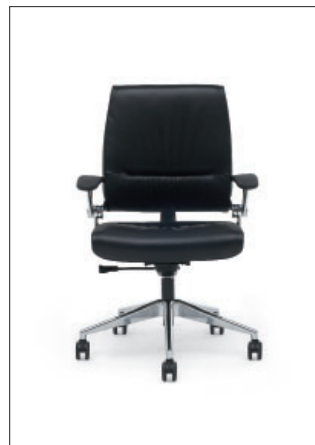

**Model # 13305
Medium Back**



OFFICE SEATING

Emissary Chair Designer – Aaron Duke

– US Only –

Model Number	Seat H"	Arm H"	W"	D"	H"	Fabric Yds.	Leather Sq. Ft.	COM	COL	Neather	Verde	Grano	Cremoso	KnollTextiles				
														1	2	3	4	
EMISSARY LOW BACK																		
	10061	18½-21	25-28	25	24	39-42	1¼	32	2,645	2,785	2,845	3,735	3,935	4,040	2,850	2,985	3,150	3,310
EMISSARY MEDIUM BACK																		
	10062	18½-21½	25-28	25	24	44-47	2	36	2,660	2,800	2,885	3,870	4,090	4,210	2,890	3,045	3,235	3,420
EMISSARY HIGH BACK																		
	10063	18½-21½	25-28	25	24	49-52	2¼	41	2,685	2,825	2,925	4,050	4,295	4,430	2,950	3,125	3,335	3,540

Standard Features:

- Rigid polyurethane inner shell
- Over molded with soy based flexible polyurethane foam
- Pneumatic height adjustment
- Back tilt locking mechanism
- Carpet casters
- Black five-star base & casters
- Leather upholstered arm cap
- For chair with COM & KnollTextiles upholstery finish, leather upholstered arm cap is available in Nienkämper Verde/Grano/Cremoso leather

Optional Features:

- Hard floor casters, black, add \$85 list per chair
- Glides with self return base & pneumatic height adjustment, add \$105 list per chair
- Polished aluminum five-star base with chrome casters, add \$205 list

Model # 10063



Emissary high back chair fully upholstered in Cremoso leather, black CM795 with polished chrome base

SIDE CHAIRS

HSC Designer - HUB Design Studio

— US Only —
Knoll Textiles

Model Number	Seat H"	W"	D"	H"	Fabric Yds.	Leather Sq. Ft.	COM	COL	Neather	Verde	Grano	Cre moso	1	2	3	4
--------------	---------	----	----	----	-------------	-----------------	-----	-----	---------	-------	-------	----------	---	---	---	---

HSC CHAIR ON CASTER BASE

	38803	17-20	25¾	24	31-34	2½	45	2,035	2,140	2,280	3,395	3,630	3,745	2,325	2,520	2,760	2,985
--	--------------	-------	-----	----	-------	----	----	-------	-------	-------	-------	-------	-------	-------	-------	-------	-------

Standard Features:

- Seat depth: 18"; Seat width: 20½"
- Molded foam frame with flexible foam on seat and back.
- 5 star caster base is standard in mirror polished finish with chrome carpet casters.
- Pneumatic height adjustment and back tilt locking mechanism are standard features for caster base.

Model #38803



OFFICE SEATING

Nienkämper NOW® Chair Designer - Mark Müller

- US Only -



Fixed Aluminum Arm Supports – Polished Finish
(Available in Black Paint)



Multifunctional Armrest

Multifunctional Arm Adjustments



Depth Adjustment
• 5 Positions
• 2" Range of Motion



Height Adjustment
• 12 Positions
• 4 3/8" Range of Motion



Swivel Adjustment
• Left Swivel = 15°
• Right Swivel = 15°



Width Adjustment
• 3 Positions
• Interior Arm Clearance= 18 1/2" to 20 3/4" (Can be increased up to 20 1/2" to 22 3/4")



Black Glides (Plastic)
Available with Self-Return Base



Chrome Glides
Available with Self-Return Base



75mm Black Plastic Casters
Also available with soft-wheel







75mm Casters
(Chrome Centre Strip)
Also available with soft wheel, or
Electrical Static Discharge version



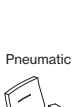

OFFICE SEATING

Nienkämper NOW® Chair Designer - Mark Müller



– US Only –

Model Number	Seat H"	Arm H"	W"	D"	H"	Fabric Yds.	Leather Sq. Ft.	COM	COL	Neather	Verde	Grano	Cremoso	Knoll Textiles			
														1	2	3	4
FULLY UPHOLSTERED																	
Pneumatic Height Adjustment on Casters																	
	13050	Black Painted Arm Supports, Black Plastic Base, Black Casters															
	18-21	24½-27½	26	25	36½-39½	1¼	28	1,730	1,765	1,920	2,575	2,845	2,955	1,935	2,070	2,240	2,395
	13052	Black Painted Arm Supports, Polished Alum. Base, Chrome Casters															
	18-21	24½-27½	26	25	36½-39½	1¼	28	1,930	1,970	2,290	2,770	3,045	3,150	2,135	2,270	2,440	2,595
	13024	Polished Arm Supports, Black Plastic Base, Black Casters															
	18-21	24½-27½	26	25	36½-39½	1¼	28	1,810	1,850	2,005	2,645	2,920	3,015	2,015	2,150	2,320	2,475
	13022	Polished Arm Supports, Polished Alum. Base, Chrome Casters															
	18-21	24½-27½	26	25	36½-39½	1¼	28	2,010	2,045	2,190	2,845	3,125	3,225	2,215	2,350	2,515	2,675
	13058	Multifunctional Armrests, Black Plastic Base, Black Casters															
	18-21	24½-27½	27½	25	36½-39½	1¼	28	1,730	1,765	1,925	2,575	2,845	2,955	1,935	2,070	2,240	2,395
	13060	Multifunctional Armrests, Polished Alum. Base, Chrome Casters															
	18-21	24½-27½	27½	25	36½-39½	1¼	28	1,930	1,970	2,130	2,770	3,045	3,150	2,135	2,270	2,440	2,595

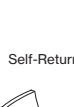
Pneumatic Height Adjustment on Glides

	13062	Black Painted Arm Supports, Black Plastic Base, Black Glides														
	18-21	24½-27½	26	25	36½-39½	1¼	28	1,690	1,720	1,870	2,510	2,795	2,890	1,890	2,030	2,195
	13064	Black Painted Arm Supports, Polished Alum. Base, Chrome Glides														
	18-21	24½-27½	26	25	36½-39½	1¼	28	1,840	1,885	2,025	2,670	2,960	3,060	2,045	2,180	2,350
	13028	Polished Arm Supports, Black Plastic Base, Black Glides														
	18-21	24½-27½	26	25	36½-39½	1¼	28	1,755	1,805	1,940	2,595	2,870	2,970	1,960	2,095	2,265
	13027	Polished Arm Supports, Polished Alum. Base, Chrome Glides														
	18-21	24½-27½	26	25	36½-39½	1¼	28	1,920	1,945	2,115	2,750	3,035	3,130	2,125	2,260	2,430
	13070	Multifunctional Armrests, Black Plastic Base, Black Glides														
	18-21	24½-27½	27½	25	36½-39½	1¼	28	1,690	1,720	1,870	2,510	2,795	2,890	1,890	2,030	2,195
	13072	Multifunctional Armrests, Polished Alum. Base, Chrome Glides														
	18-21	24½-27½	27½	25	36½-39½	1¼	28	1,840	1,885	2,035	2,670	2,960	3,060	2,045	2,180	2,350

Self-Return Jury Base with Pneumatic Height Adjustment

	13074	Black Painted Arm Supports, Black Aluminum Jury Base														
	18-22	24½-27½	26	25	36½-40½	1¼	28	1,905	1,995	2,055	2,670	2,890	3,015	2,110	2,245	2,410
	13076	Polished Painted Arm Supports, Black Aluminum Jury Base														
	18-22	24½-27½	26	25	36½-40½	1¼	28	1,940	2,040	2,125	2,720	2,975	3,070	2,145	2,280	2,450
	13078	Multifunctional Armrest, Black Aluminum Jury Base														
	18-22	24½-27½	27½	25	36½-40½	1¼	28	1,915	2,005	2,060	2,670	2,950	3,040	2,120	2,255	2,425

Nienkämper NOW chair passes CAL 133 certified for an upcharge of \$390 list per chair. Certification applies to Nienkämper leathers and fabrics that have a minimum of 50% natural fibre content. COM's and COL's are subject to approval. Add the extension "-CAL" to the model number when ordering.

The Nienkämper NOW® Chair brings Nienkämper's renowned fine upholstery and contemporary aesthetics to the conference-room chair. Height, back and tilt controls, firm lumbar support and a contoured back ensure a comfortable, ergonomic sitting experience. Top stitching on the edges, a distinctive Y detail on the back and a tuck on the seat and back emphasize the chair's crisp, tailored elegance.

Standard Features:

- Locking tilt with return safety function
- Pneumatic height adjustment
- Synchronized seat-and-back recline
- Tilt tension control
- Top-stitch detail on seat and back covers
- Jury base for auditorium seating
- Large 75mm, unhooded, hard wheel casters (for soft flooring)
- Chrome (zinc) or black (plastic) glides
- 26" diameter five-star base

Suffix	Optional Features:	
"A"	• Armless (remove painted arm supports)	(deduct \$160 list)
"B"	• Verde, Grano or Cremoso leather upholstered arm pads (for painted or polished arm supports)	(add \$190 list)
	- plus additional 3 sq.ft. of COL	
"C"	• Verde, Grano or Cremoso leather upholstered arm pads & panels (remove painted arm supports)	(add \$575 list)
	- plus additional 11 sq.ft. of COL	
"D"	• Contrast stitching (leather covers only)	(no upcharge)
"CAL"	• CAL 133 Certified applies to leather & fabric that has a minimum 50% natural fibre content. COM & COL subject to approval.	(add \$390 list)
Caster Chair Options:		
"E"	• Soft wheel caster (for hard floors); Black	(add \$85 list)
"F"	• Soft wheel caster (for hard floors); Chrome	(add \$100 list)
"G"	• Hard wheel Electrical Static Discharge (ESD) caster; Chrome (for soft flooring)	(add \$150 list)
"H"	• Fixed-height cylinder (no height adjustment, with swivel)	(no upcharge)
Glide Chair Options:		
"I"	• Self-Return Base with Pneumatic Height Adjustment	(add \$105 list)

OFFICE SEATING

Senator® Boardroom Designer – Nienkämper

– US Only –

Model Number	Seat H"	Arm		D"	H"	Fabric Yds.	Leather Sq. Ft.	COM	COL	Neather	Verde	Grano	Cremoso	Knoll Textiles			
		H"	W"											1	2	3	4
LOW BACK																	
	1464	18½ - 21½	25	25	36												
(Model #1)	Urethane arm					1¼	22	2,185	2,285	2,345	3,090	3,330	3,435	2,390	2,530	2,695	2,855
(Model #9)	Urethane arm with wrap					1½	24	2,415	2,550	2,595	3,465	3,725	3,835	2,590	2,710	2,855	2,990
(Model #2)	Urethane arm with cap					1½	24	2,415	2,550	2,595	3,465	3,725	3,835	2,590	2,710	2,855	2,990
(Model #3)	Urethane arm with cap and wrap					1¾	26	2,485	2,615	2,710	3,610	3,915	4,015	2,690	2,825	2,995	3,150

MEDIUM BACK

	1465	18½ - 21½	25	25	40½												
(Model #1)	Urethane arm					1¼	30	2,225	2,335	2,365	3,450	3,775	3,915	2,370	2,470	2,585	2,700
(Model #9)	Urethane arm with wrap					1½	32	2,440	2,575	2,640	3,775	4,115	4,250	2,610	2,730	2,875	3,010
(Model #2)	Urethane arm with cap					1½	32	2,440	2,575	2,640	3,775	4,115	4,250	2,610	2,730	2,875	3,010
(Model #3)	Urethane arm with cap and wrap					1¾	34	2,535	2,650	2,740	3,845	4,200	4,340	2,740	2,875	3,040	3,200

HIGH BACK

	1466	18½ - 21½	25	25	45												
(Model #1)	Urethane arm					1¼	36	2,260	2,370	2,440	3,545	3,875	4,005	2,405	2,505	2,620	2,740
(Model #9)	Urethane arm with wrap					1¾	38	2,495	2,640	2,720	3,870	4,225	4,365	2,700	2,835	3,005	3,165
(Model #2)	Urethane arm with cap					1¾	38	2,495	2,640	2,670	3,735	4,065	4,200	2,700	2,835	3,005	3,165
(Model #3)	Urethane arm with cap and wrap					2	40	2,585	2,710	2,835	3,950	4,300	4,465	2,815	2,975	3,165	3,345

Senator Boardroom series is available as CAL 133 certified for an upcharge of \$390 list per chair. Certification applies to Nienkämper leathers and fabrics that have a minimum of 50% natural fibre content. COM's and COL's are subject to approval. Add the extension "-CAL" to the model number when ordering.

Specify model number for arm selection.

Standard Features:

- Pneumatic height adjustment
- Back tilt locking mechanism
- Back tilt tension control
- Carpet casters
- Black five-star base

Optional Features:

- Hard floor casters, Black, add \$85 list per chair
- Glides, add \$105 list per chair
- Polished aluminum five-star base with chrome casters, add \$205 list

Model # 14652
Medium Back

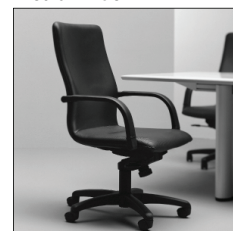

Model # 14652
Medium Back

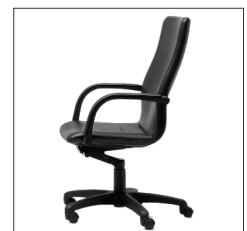

OFFICE SEATING

Senator® CEO Designer – Nienkämper

– US Only –

Model Number	Seat H"	Arm H"	W"	D"	H"	Fabric Yds.	Leather Sq. Ft.	COM	COL	Verde	Grano	Cremoso	Knoll Textiles					
													1	2	3	4		
LOW BACK																		
1461__	18½-21½	25	25	28	36													
(Model #1)	Urethane arm					2	34											
(Model #9)	Urethane arm with wrap					2¼	37	3,225	3,385	4,550	4,900	5,030	3,455	3,615	3,805	3,985		
(Model #2)	Urethane arm with cap					2¼	27	3,475	3,635	4,950	5,345	5,505	3,735	3,915	4,125	4,330		
(Model #3)	Urethane arm with cap and wrap					2½	39	3,475	3,635	4,950	5,345	5,505	3,735	3,915	4,125	4,330		
(Model #8)	Closed arm					2¾	44	3,570	3,730	5,205	5,635	5,815	3,860	4,060	4,295	4,525		
								3,955	4,160	5,775	6,250	6,440	4,270	4,490	4,755	5,000		

MEDIUM BACK

1462__	18½-21½	25	25	28	40½													
(Model #1)	Urethane arm					2¼	38	3,375	3,530	4,850	5,260	5,400	3,635	3,815	4,025	4,230		
(Model #9)	Urethane arm with wrap					2½	41	3,595	3,775	5,260	5,695	5,865	3,880	4,080	4,320	4,545		
(Model #2)	Urethane arm with cap					2½	41	3,595	3,775	5,260	5,695	5,865	3,880	4,080	4,320	4,545		
(Model #3)	Urethane arm with cap and wrap					2¾	43	3,700	3,875	5,510	5,985	6,185	4,015	4,235	4,495	4,745		
(Model #8)	Closed arm					3	48	4,080	4,295	6,055	6,585	6,805	4,430	4,665	4,950	5,220		

HIGH BACK

1463__	18½-21½	25	25	28	45													
(Model #1)	Urethane arm					2½	40	4,015	4,220	5,680	6,110	6,295	4,300	4,500	4,740	4,965		
(Model #9)	Urethane arm with wrap					2¾	43	3,475	4,475	6,100	6,555	6,760	3,790	4,010	4,270	4,515		
(Model #2)	Urethane arm with cap					2¾	43	4,275	4,475	6,100	6,555	6,760	4,590	4,810	5,075	5,320		
(Model #3)	Urethane arm with cap and wrap					3	45	4,360	4,575	6,350	6,860	7,080	4,705	4,945	5,225	5,500		
(Model #8)	Closed arm					3¼	50	4,770	5,005	6,920	7,465	7,690	5,140	5,405	5,710	6,005		

Senator CEO series is available as CAL 133 certified for an upcharge of \$390 list per chair. Certification applies to Nienkämper leathers and fabrics that have a minimum of 50% natural fibre content. COM's and COL's are subject to approval. Add the extension "-CAL" to the model number when ordering.

Specify model number for arm selection.

Standard Features:

- Pneumatic height adjustment
- Back tilt locking mechanism
- Back tilt tension control
- Carpet casters
- Black five-star base

Optional Features:

- Hard floor casters, Black, add \$85 list per chair
- Glides, add \$105 list per chair
- Polished aluminum five-star base with chrome casters, add \$205 list





Model # 14622
Medium Back





OFFICE SEATING

Senator® Executive Designer – Nienkämper



– US Only –

Model Number	Seat H"	Arm				Fabric Leather		COM	COL	Neather	Verde	Grano	Cremoso	KnollTextiles				
		H"	W"	D"	H"	Yds.	Sq. Ft.							1	2	3	4	
LOW BACK																		
 	1411_	18½ - 21½	25	25	26	36												
(Model #1) Urethane arm							1¼	32	2,980	3,130	3,200	4,300	4,655	4,795	3,185	3,320	3,490	3,645
(Model #2) Urethane arm with cap							2	35	3,225	3,385	3,475	4,680	5,050	5,200	3,455	3,615	3,805	3,985
 	(Model #3) Urethane arm with cap & wrap						2¼	37	3,280	3,465	3,570	4,820	5,210	5,380	3,540	3,720	3,930	4,135
(Model #8) Closed arm							2¾	42	3,685	3,845	4,000	5,400	5,865	6,045	4,000	4,220	4,480	4,725
(Model #7) Sled base with cap							2¼	34	4,070	4,280	4,350	5,480	5,840	5,995	4,335	4,510	4,720	4,925

MEDIUM BACK

 	1412_	18½ - 21½	25	25	26	40½												
(Model #1) Urethane arm							2	36	3,125	3,270	3,375	4,605	5,005	5,155	3,355	3,515	3,705	3,885
(Model #2) Urethane arm with cap							2¼	39	3,330	3,495	3,595	4,945	5,375	5,530	3,595	3,770	3,980	4,185
(Model #3) Urethane arm with cap & wrap							2½	41	3,435	3,595	3,730	5,125	5,575	5,735	3,725	3,925	4,160	4,385
(Model #8) Closed arm							3	46	3,800	3,985	4,160	5,695	6,185	6,390	4,145	4,380	4,665	4,935

HIGH BACK

 	1413_	18½ - 21½	25	25	26	45												
(Model #1) Urethane arm							2¼	38	3,730	3,920	4,000	5,295	5,710	5,875	3,990	4,170	4,380	4,585
(Model #2) Urethane arm with cap							2½	41	3,960	4,165	4,275	5,645	6,105	6,295	4,250	4,450	4,685	4,910
(Model #3) Urethane arm with cap & wrap							2¾	43	4,050	4,245	4,370	5,815	6,295	6,475	4,365	4,585	4,850	5,095
(Model #8) Closed arm							3	48	4,425	4,615	4,790	6,390	6,920	7,130	4,770	5,005	5,290	5,560

Senator Executive series is available as CAL 133 certified for an upcharge of \$390 list per chair. Certification applies to Nienkämper leathers and fabrics that have a minimum of 50% natural fibre content. COM's and COL's are subject to approval. Add the extension "-CAL" to the model number when ordering.

Specify model number for arm selection.

Standard Features:

- Pneumatic height adjustment
- Back tilt locking mechanism
- Tension control
- Carpet casters
- Black five-star base

Optional Features:

- Hard floor casters, Black, add \$85 list per chair
- Glides, add \$105 list per chair
- Polished aluminum five-star base with chrome casters, add \$205 list
- Chrome finish sled base, add \$190 list

Upholstery Details:

- Leather upholstery has channel stitching.
- Fabric upholstery is available with channel stitch finished with a French seam detail.

Model # 14122
Medium Back



Model # 1
Urethane Arm



Model # 2
Urethane arm
with Cap



Model # 3
Urethane Arm with
Cap and Wrap



Model # 8
Closed Arm



OFFICE SEATING

Senator Mesh Back Chair Designer – Nienkämper

– US Only –

Model Number	Seat H"	Arm		D"	H"	Fabric Yds.	Leather Sq. Ft.	Knoll Textiles			
		H"	W"					COM	COL	Neather	Verde

SENATOR MESH BACK CHAIR - ADJUSTABLE ARMS



Model	Seat H"	Arm H"	Arm W"	D"	H"	Fabric Yds.	Leather Sq. Ft.	COM	COL	Neather	Verde	Grano	Cremoso	1	2	3	4			
Gray arms, back frame and base								Upholstered seat												
14301	17½	21½	23½	23½	24	36¼	40¼	¾	14	1,185	1,240	1,270	1,625	1,705	1,740	1,275	1,330	1,405	1,470	
Gray arms, back frame and base								Mesh seat												
14302	17½	21½	23½	23½	24	36¼	40¼			1,185										
Black arms, back frame and base								Upholstered seat												
14305	17½	21½	23½	23½	24	36¼	40¼	¾	14	1,120	1,165	1,195	1,560	1,635	1,670	1,210	1,270	1,340	1,410	
Black arms, back frame and base								Mesh seat												
14306	17½	21½	23½	23½	24	36¼	40¼			1,120										

Standard Features:

- Mesh back, fabric seat & headrest is standard in black
- Mesh back with lumbar support, lumbar support has 2" adjustment
- Adjustment arms with 3" height adjustment and 1¾" depth adjustment
- Pneumatic height adjustment
- Black or grey five star base is standard, add \$205 list for polished aluminum base with chrome casters

Model # 14301



Model # 14301



OFFICE SEATING

Slim Chair Designer – Nienkämper

– US Only –

Model Number	Seat H"	Arm H"	W"	D"	H"	Fabric Yds.	Leather Sq. Ft.	COM	COL	Neather	Verde	Grano	Cremoso	Knoll Textiles			
														1	2	3	4

SLIM HIGH BACK - ARMLESS



10761	19-22		19	25	45	1¾	30	1,465	1,545	1,655	2,470	2,635	2,720	1,660	1,795	1,950	2,095
-------	-------	--	----	----	----	----	----	-------	-------	-------	-------	-------	-------	-------	-------	-------	-------

SLIM HIGH BACK - FIXED ARM



10762	19-22	26-29	25½	25	45	1¾	30	1,765	1,850	1,945	2,770	2,950	3,030	1,960	2,090	2,250	2,395
-------	-------	-------	-----	----	----	----	----	-------	-------	-------	-------	-------	-------	-------	-------	-------	-------

SLIM HIGH BACK - CANTILEVER ARM



10763	19-22	26-29	25½	25	45	1¾	30	1,730	1,805	1,885	2,540	2,700	2,775	1,925	2,055	2,215	2,360
-------	-------	-------	-----	----	----	----	----	-------	-------	-------	-------	-------	-------	-------	-------	-------	-------

Standard Features:

- Molded plywood seat shell
- Soy based flexible polyurethane foam
- Fixed arm model has polished aluminum arm supports and black soft textured arm cap
- Cantilever arm model has polished sides with black textured arm cap
- Pneumatic height adjustment
- Back tilt locking mechanism
- Carpet casters
- Black five-star base & casters

Optional Features:

- Hard floor casters, Black, add \$85 list per chair
- Glides, add \$105 list per chair
- Polished aluminum five-star base with chrome casters, add \$205

Model # 10761



Model # 10762



Model # 10763



Slim high back with cantilever arms with polished sides and black textured arm cap

OFFICE SEATING

Trench - Upholstered Arms Designer – Favaretto & Partners

– US Only –

Model Number	Seat H"	Arm H"	W"	D"	H"	Fabric Yds.	Leather Sq. Ft.	COM	COL	Neather Verde	Grano Cremoso	KnollTextiles			
												1	2	3	4

TRENCH LOW BACK - UPHOLSTERED ARMS



10371	18-21	27-30	25½	26	35½-38½	2½	45	2,610	2,745	2,860	4,000	4,240	4,355	2,900	3,100	3,335	3,560
-------	-------	-------	-----	----	---------	----	----	-------	-------	-------	-------	-------	-------	-------	-------	-------	-------

TRENCH MEDIUM BACK - UPHOLSTERED ARMS



10372	18-21	27-30	25½	26	40½-43½	3	54	2,730	2,865	3,030	4,370	4,665	4,800	3,080	3,315	3,600	3,870
-------	-------	-------	-----	----	---------	---	----	-------	-------	-------	-------	-------	-------	-------	-------	-------	-------

TRENCH HIGH BACK WITH HEADREST - UPHOLSTERED ARMS



10373	18-21	27-30	25½	26	48½-51½	3-½	63	3,100	3,265	3,450	5,015	5,350	5,515	3,505	3,780	4,115	4,430
-------	-------	-------	-----	----	---------	-----	----	-------	-------	-------	-------	-------	-------	-------	-------	-------	-------

Standard Features:

- Seat depth : 20"D, Headrest : 8"H
- Steel frame with polyurethane foam
- Distinctive pleats on the convex inside back for both leather & fabric upholstery is standard in Verde leather
- Extra 5 sqft. COL is required for pleat detail
- Upholstered arms and adjustable arms are both available
- Pneumatic height adjustment
- Synchronized seat and back recline
- Black five star base and 3" dia. carpet casters are standard
- Add \$205 list for mirror polished base with chrome casters

Model # 10372



Trench medium back chair upholstered in Ecopell leather, color Caramel EC363 with Ecopell leather, color Milkshake EC737 pleats detail on inside back

nienkämpfer

SEATING & MEETING PODS

SIDE CHAIRS



2026

SIDE CHAIRS

TABLE OF CONTENTS

Side Chairs	24-28
HSC	26
Kush	27
Senator® Nuvo Sled Base	28

SIDE CHAIRS

HSC Designer - HUB Design Studio

Model Number	Seat H"	W"	D"	H"	Fabric Yds.	Leather Sq. Ft.	- US Only - Knoll Textiles							
							COM	COL	Neather	Verde	Grano	Cremoso	1	2

HSC CHAIR ON WOOD LEGS



38801	17	25¾	24	31	2½	45	2,645	2,780	2,900	4,040	4,275	4,390	2,930	3,130	3,370	3,595
--------------	----	-----	----	----	----	----	-------	-------	-------	-------	-------	-------	-------	-------	-------	-------

HSC CHAIR ON STEEL LEGS



38802	17	25¾	24	31	2½	45	2,115	2,220	2,360	3,465	3,705	3,825	2,400	2,600	2,835	3,065
--------------	----	-----	----	----	----	----	-------	-------	-------	-------	-------	-------	-------	-------	-------	-------

Standard Features:

- Seat depth: 18"; Seat width: 20 ½"
- Molded foam frame with flexible foam on seat and back.
- Wood legs available in 3 species: solid yellow birch, maple or walnut and finished natural or stained with any Nienkämper standard color.
- Steel legs available in silver, black or warm white powder coat finish.

Model #38801



Model #38802



SIDE CHAIRS

Kush Designer - MSDS Studio

– US Only –

Model Number	Seat H"	Arm H"	W"	D"	H"	Fabric		COM	COL	Neather	Verde	Grano Cremoso	Knoll Textiles			
						Yds.	Sq. Ft.						1	2	3	4

KUSH

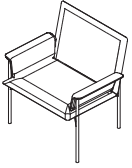

10360	19½	25½	28	25	34	3	54	2,940	3,080	3,230	3,300	4,870	5,020	3,290	3,525	3,810	4,080
-------	-----	-----	----	----	----	---	----	-------	-------	-------	-------	-------	-------	-------	-------	-------	-------

Standard Features:

- Frame is constructed from plywood core
- Seat & back cushions have a foam core with Dacron wrap
- Upholstered arm support with polyurethane foam
- Legs are standard in black powder coat finish

Model # 10360

Kush chair upholstered in Ecopell leather, color Caramel EC 363.



OFFICE SEATING

Senator® Nuvo Designer – Nienkämper

– US Only –

Model Number	Seat H"	Arm H"	W"	D"	H"	Fabric Yds.	Leather Sq. Ft.	COM	COL	Verde	Grano	Cremoso	Knoll Textiles			
													1	2	3	4

ARMCHAIR SLED BASE



14103 17½ 24½ 23 25 31 1¼ 32

2,360 2,475 3,035 3,320 3,390 2,565 2,700 2,870 3,025

Standard Features

- Chrome tubular sled base
- Plain upholstery

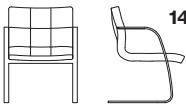

14104 17½ 24½ 23 25 31 1¼ 32

3,630 3,815 4,300 4,585 4,680 3,835 3,970 4,140 4,295

Standard Features

- Solid flat chrome sled base
- Tufted upholstery

ARMCHAIR CASTER BASE



14107 17½ 24½ 23 25 31 1¼ 32

2,585 2,715 3,245 3,475 3,530 2,790 2,925 3,095 3,250

Standard Features:

- Chrome or black base
- Chrome or black casters
- Plain upholstery

Model # 14103
Senator® Nuvo Armchair
with tubular chrome sled base



Model # 14105
Senator® Nuvo Armchair
with flat chrome sled base

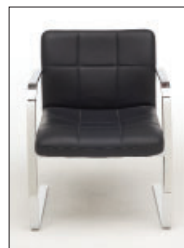

Model # 14107
Senator® Nuvo Armchair Caster Base



nienkämpfer

SEATING & MEETING PODS

LOUNGE FURNITURE



2026

LOUNGE SEATING
TABLE OF CONTENTS

Lounge Seating

29-83

Bare	31	Kloud® Serpentine™	60
BASS Collection	32-33	Leaf	61
Bay	34	Nordic	62
Beam Lounge	35-36	Note	63
Berkley® Collection	37-42	Radius	64-65
Blob	43	Rowan Lounge	66
Carlisle	44	Satori™	67
Dobi	45	Six® Collection	68
Dune	46	Turnaround® Collection	69
Elite	47	Tuxedo™	70-71
Gateway Lounge	48-53		
Godbout	54	Tuxedo™ Classic	72-75
Heartbeat	55-56	Tuxedo™ Cove	73-79
Isola 8	57	Tuxedo™ High Back	80-81
J + J Studio	58	Wavelength®	82-83
Kloud® Collection	59		

LOUNGE SEATING

Bare Designer - Evan Bare

– US Only –

Model Number	Seat Arm			D"	H"	Fabric Yds.	Leather Sq. Ft.	COM	COL	Neather	Verde	Grano	Cremoso	Knoll Textiles			
	H"	H"	W"											1	2	3	4

BARE CHAIR



10321	16¾	26	33	29 ½	3¾	68											
						Seat	1¼	23									
						Back	2 ½	45									

5,100	5,370	5,510	7,380	7,750	7,950	5,530	5,830	6,185	6,525
-------	-------	-------	-------	-------	-------	-------	-------	-------	-------

BARE TWO SEAT SOFA

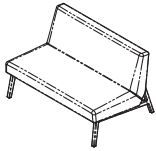

10322	16¾	50	33	29 ½	5¾	104											
						Seat	2¼	41									
						Back	3 ½	63									

6,875	7,220	7,630	10,300	10,885	11,175	7,535	7,995	8,540	9,060
-------	-------	-------	--------	--------	--------	-------	-------	-------	-------

Model # 10321
Bare Chair



Model # 10322
Bare Two Seat Sofa



Standard Features:

- Seat depth: 21"d
- Plywood frame with soy based polyurethane foam.
- Solid maple or walnut legs are standard in ebonized finish but also available in any Nienkämper stains.
- Custom stain is available with upcharge.

LOUNGE SEATING

BASS Collection Designer - Busk + Hertzog

– US Only –

Model Number	Seat H"	Arm H"	W"	D"	H"	Fabric		COM	COL	Verde	Grano	Cremoso	Knoll Textiles			
						Yds.	Sq. Ft.						1	2	3	4

BASS LOW BACK SMALL LOUNGE CHAIR

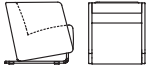

12011	17	26½	27	29	26½	5	90
		seat & back				3	54
		arms				3½	63

3,630	3,820	6,565	7,170	7,475	4,200	4,600	5,075	5,525
-------	-------	-------	-------	-------	-------	-------	-------	-------

BASS LOW BACK LARGE LOUNGE CHAIR

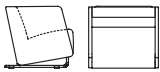

12012	17	26½	32	29	26½	6½	99
		seat & back				3	54
		arms				3½	63

3,760	3,960	6,965	7,630	7,950	4,505	5,025	5,640	6,230
-------	-------	-------	-------	-------	-------	-------	-------	-------

BASS LOW BACK 2 SEATER SOFA

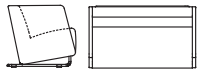

12013	17	26½	59	29	26½	7½	135
		seat & back				5	90
		arms				3½	63

5,035	5,290	8,670	9,420	9,800	5,900	6,495	7,205	7,885
-------	-------	-------	-------	-------	-------	-------	-------	-------

BASS LOW BACK 3 SEATER SOFA



12014	17	26½	82	29	26½	9½	171
		seat & back				7	126
		arms				3½	63

6,990	7,350	11,085	11,910	12,320	8,080	8,840	9,735	10,590
-------	-------	--------	--------	--------	-------	-------	-------	--------

Standard Features:

- Frame is constructed of hardwood, plywood and soy-based polyurethane foam.
- Polished chrome tubular base

Model # 12011

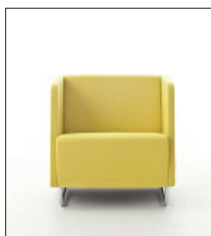

Model # 12013



Model # 12014



LOUNGE SEATING

BASS Collection Designer - Busk + Hertzog

– US Only –

Model Number	Seat H"	Arm H"	W"	D"	H"	Fabric		COM	COL	Verde	Grano	Cremoso	Knoll Textiles			
						Yds.	Sq. Ft.						1	2	3	4

BASS HIGH BACK LARGE LOUNGE CHAIR

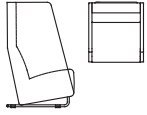

12024	17	46½	32	29	46½	7	126	5,185	5,455	8,945	9,720	10,110	5,985	6,545	7,205	7,840
		seat & back				4 ½	81									
		arms				5 ⅓	96									

BASS HIGH BACK 2 SEATER SOFA

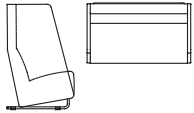

12022	17	46½	59	29	46½	11	198	6,545	6,875	12,365	13,595	14,195	7,805	8,680	9,720	10,720
		seat & back				6 ¾	122									
		arms				5 ⅓	96									

BASS HIGH BACK 3 SEATER SOFA

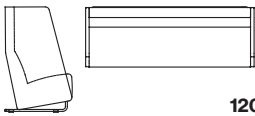

12023	17	46½	82	29	46½	13	234	8,595	9,030	15,525	16,955	17,680	10,090	11,120	12,350	13,525
		seat & back				9	162									
		arms				5 ⅓	96									

Model # 12022



Model # 12023



Standard Features:

- Frame is constructed of hardwood, plywood and soy-based polyurethane foam.
- Polished chrome tubular base



LOUNGE SEATING

Bay Designer - Busk + Hertzog

– US Only –

Model Number	Seat H"	W"	D"	H"	Fabric Yds.	Leather Sq. Ft.	COM	COL	Neather	Verde	Grano	Cremoso	Knoll Textiles			
													1	2	3	4

BAY CHAIR WITH UPHOLSTERED BASE

	10520	16	26	27¾	26¼	¾	59	2,915	3,070	3,280	4,830	5,185	5,370	3,290	3,550	3,855	4,150	
	Fully upholstered																	
	10521	Contrasting Fabric							2,915		3,280				3,290	3,550	3,855	4,150
		Seat				1¾												
		Base				1½												
	10522	Contrasting Leather							3,070		4,830	5,185	5,370					
		Seat					32											
		Base					27											
	10523	16½	26	27¾	26¼	¾	59	3,475	3,625	3,835	5,390	5,740	5,925	3,845	4,110	4,410	4,705	
	Fully upholstered w/ swivel																	
	10524	Contrasting Fabric w/ Swivel							3,475		3,835				3,845	4,110	4,410	4,705
			Seat				1¾											
		Base				1½												
	10525	Contrasting Leather w/ Swivel							3,625		5,390	5,740	5,925					
		Seat					32											
		Base					27											

Standard Features:

- Seat with plywood shell and soy based flexible polyurethane foam
- Base in rigid polyurethane
- Base with plastic glides on bottom
- Standard swivel mechanism rotates 360° and is weight rated for 400lbs
- Swivel base disk constructed of ¼" steel and powder coated black
- Add \$165 list to price of swivel base if a memory return swivel is desired

Model # 10521



LOUNGE SEATING

Beam Collection - Designer - Kenny Nguyen

– US Only –

Model Number	Seat H"	W"	D"	H"	Yds.	Fabric	Leather	Sq. Ft.	COM	COL	Neather	Verde	Grano	Cremoso	KnollTextiles			
															1	2	3	4

BEAM OTTOMAN



14929	16 3/4	28	31	16 3/4	4	72			2,835	2,980	3,160	5,000	5,345	5,700	3,300	3,615	3,990	4,355
-------	--------	----	----	--------	---	----	--	--	-------	-------	-------	-------	-------	-------	-------	-------	-------	-------

BEAM LOUNGE CHAIR



14931	16 3/4	28 5/8	39 3/4	31	4.5	100			3,690	3,875	4,140	6,745	7,185	7,735	4,210	4,565	4,990	5,395
-------	--------	--------	--------	----	-----	-----	--	--	-------	-------	-------	-------	-------	-------	-------	-------	-------	-------

BEAM 2 SEAT



14932	16 3/4	58 5/8	39 3/4	31	9	200			7,370	7,740	8,270	13,475	14,355	15,460	8,400	9,115	9,965	10,780
-------	--------	--------	--------	----	---	-----	--	--	-------	-------	-------	--------	--------	--------	-------	-------	-------	--------

BEAM 3 SEAT



14933	16 3/4	88 5/8	39 3/4	31	13.5	300			11,055	11,610	12,410	20,210	21,535	23,185	12,600	13,680	14,955	16,170
-------	--------	--------	--------	----	------	-----	--	--	--------	--------	--------	--------	--------	--------	--------	--------	--------	--------

Standard Features:

- Constructed from high resilient foam molded over wood frame
- Structural wood beam available in all standard Veneer, stains and finishes

Model # 14931



Beam Lounge Chair Back upholstered in Maharam Nico, 022 Jousting Seat upholstered in Maharam Nico, 021 Rosin



LOUNGE SEATING

Beam Collection - Designer - Kenny Nguyen

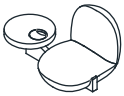
– US Only –

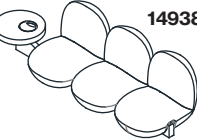
Model Number	Seat H"	W"	D"	H"	Fabric Yds.	Leather Sq. Ft.	COM	COL	Neather	Verde	Grano	Cremoso	Knoll Textiles				
													1	2	3	4	
BEAM CHAIR WITH TABLE																	
	14935	16¾	54	39¾	31	4.5	100	6,100	6,405	6,550	9,275	9,715	10,265	6,615	6,975	7,400	7,805
BEAM 2 SEAT WITH END TABLE																	
	14936	16¾	84½	39¾	31	9	200	9,780	10,270	10,680	16,005	16,885	17,990	10,810	11,525	12,375	13,190
BEAM 2 SEAT WITH MID TABLE																	
	14937	16¾	84	39¾	31	9	200	9,780	10,270	10,680	16,005	16,885	17,990	10,810	11,525	12,375	13,190
BEAM 3 SEAT WITH END TABLE																	
	14938	16¾	114¾	39¾	31	13.5	300	13,465	14,140	14,820	22,740	24,065	25,715	15,010	16,090	17,365	18,580

Model # 14937

Beam Lounge Chair Upholstered in Maharam Nico, 022 Jousting Rift cut, creamy walnut veneer table and beam finish

Table courtesy power with cover

Standard Features:

- Constructed from high resilient foam molded over wood frame
- Structural wood beam available in all standard Veneer, stain and finish
- Tables are standard with a courtesy 1 power & dual USB A+C Charger in white finish.



LOUNGE SEATING

The Berkley® Collection Designer - Nienkämper

– US Only –

Model Number	Seat H"	W"	D"	H"	Fabric Yds.	Leather Sq. Ft.	COM	COL	Neather	Verde	Grano	Cremoso	Knoll Textiles						
													1	2	3	4			
SINGLE ELEMENT																			
	13410_	16	24	35	27 ½														
	/1	Armless with metal legs				3 ¾	60	3,475	3,730	3,740	4,985	5,395	5,560	3,905	4,200	4,560	4,895		
	/2	8 Angled arm				5 ½	88	4,460	4,785	5,030	7,655	8,505	8,855	5,090	5,530	6,050	6,550		
	/3	10 Angled arm				6 ¼	100	4,590	4,930	5,180	7,830	8,655	8,995	5,310	5,810	6,395	6,965		
	/4	8 Straight arm with leg				5 ½	88	5,975	6,415	6,470	8,665	9,395	9,670	6,605	7,050	7,570	8,065		
	/5	10 Straight arm with leg				6 ¼	100	6,040	6,475	6,535	8,735	9,445	9,730	6,760	7,260	7,845	8,415		

Note: Width measurements do not include arms.

TWO SEAT ELEMENT

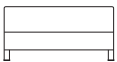
	13401_	16	48	35	27 ½														
	/1	Armless with metal legs				3 ¾	60	4,495	4,830	4,965	7,035	7,700	7,960	4,925	5,225	5,585	5,920		
	/2	8 Angled arm				5 ½	88	5,480	5,890	6,240	9,700	10,805	11,265	6,110	6,550	7,070	7,570		
	/3	10 Angled arm				6 ¼	100	5,625	6,050	6,390	9,865	10,975	11,425	6,345	6,845	7,430	8,000		
	/4	8 Straight arm with leg				5 ½	88	6,995	7,510	7,665	10,720	11,710	12,100	7,625	8,065	8,585	9,085		
	/5	10 Straight arm with leg				6 ¼	100	7,055	7,600	7,730	10,790	11,760	12,155	7,770	8,270	8,860	9,425		

Note: Width measurements do not include arms.

LARGE TWO SEAT ELEMENT

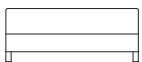
	13402_	16	60	35	27 ½														
	/1	Armless with metal legs				4 ¼	68	4,800	5,160	5,325	7,665	8,440	8,735	5,290	5,630	6,030	6,415		
	/2	8 Angled arm				6	96	5,790	6,210	6,610	10,350	11,545	12,020	6,475	6,955	7,520	8,065		
	/3	10 Angled arm				6 ¾	108	5,930	6,380	6,760	10,510	11,710	12,180	6,705	7,240	7,885	8,490		
	/4	8 Straight arm with leg				6	96	7,300	7,850	8,065	11,370	12,435	12,840	7,990	8,465	9,030	9,580		
	/5	10 Straight arm with leg				6 ¾	108	7,375	7,920	8,105	11,430	12,485	12,935	8,150	8,685	9,325	9,935		

Note: Width measurements do not include arms.

Berkley Collection passes CAL 133 certified for an upcharge of \$435 list per single element, \$870 list per 2 seat element, and \$1,095 list per large 2 seat element. Certification applies to Nienkämper leathers and fabrics that have a minimum of 50% natural fibre content. COM's and COL's are subject to approval. Add the extension -CAL to the model number when ordering.



Model # 1
Armless



Model # 2
8 Angled Arm



Model # 3
10 Angled Arm



Model # 4
8 Angled Arm



Model # 5
10 Angled Arm

LOUNGE SEATING

The Berkley® Collection Designer – Nienkämper

– US Only –

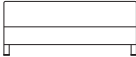
Model Number	Seat H"	W"	D"	H"	Fabric Yds.	Leather Sq. Ft.	Knoll Textiles													
							COM	COL	Neather	Verde	Grano	Cremoso	1	2	3	4				
THREE SEAT ELEMENT																				
	13403_ 16	72	35	27½																
	/1 Armless with metal legs				5	80	5,205	5,610	5,825	8,595	9,480	9,835	5,775	6,175	6,650	7,100				
	/2 8 Angled arm				6¾	108	6,185	6,640	7,120	11,260	12,585	13,150	6,965	7,500	8,140	8,750				
	/3 10 Angled arm				7⅞	120	6,340	6,805	7,255	11,415	12,735	13,280	7,190	7,785	8,485	9,160				
	/4 8 Straight arm with leg				6¾	108	7,700	8,255	8,550	12,270	13,470	13,945	8,475	9,010	9,650	10,260				
	/5 10 Straight arm with leg				7½	120	7,780	8,340	8,600	12,335	13,530	14,025	8,640	9,235	9,945	10,625				

Note: Width measurements do not include arms.

LARGE THREE SEAT ELEMENT

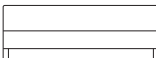
	13404_ 16	84	35	27½																
	/1 Armless with metal legs				5 ¾	92	5,730	6,150	6,430	9,635	10,640	11,045	6,390	6,850	7,395	7,915				
	/2 8 Angled arm				7½	120	6,715	7,205	7,705	12,275	13,750	14,350	7,580	8,175	8,885	9,565				
	/3 10 Angled arm				8¼	132	6,860	7,375	7,865	12,440	13,910	14,510	7,805	8,465	9,240	9,990				
	/4 8 Straight arm with leg				7½	120	8,220	8,845	9,165	13,290	14,630	15,180	9,080	9,680	10,385	11,065				
	/5 10 Straight arm with leg				8¼	132	8,305	8,900	9,210	13,365	14,695	15,240	9,250	9,910	10,685	11,430				

Note: Width measurements do not include arms.

Berkley Collection passes CAL 133 certified for an upcharge of \$1,305 list per 3 seat element, and \$1,535 per large 3 seat element. Certification applies to Nienkämper leathers and fabrics that have a minimum of 50% natural fibre content. COM's and COL's are subject to approval. Add the extension -CAL to the model number when ordering.

The Berkley Collection is a Nienkämper classic in its contemporary style and simplicity of line. This is a collection that is elegant yet generous in proportions. Berkley works well in public spaces, executive lounges, lobbies, and residences.

Frame:

Solid maple and plywood construction.

Seat and Back:

The seat and back are polyurethane foam covered in Fortrel®. Upholstered in leather or fabric. Yardages are for plain non-directional fabrics. Fabrics are railroaded.

Arms:

Two arm options are available, Angled and Straight. The Angled arm carries to the floor. The Straight arm rests on an aluminum base.

Base:

On models with Angled arms, the base is solid maple runners painted matte black. Aluminum bases are available in a brushed, polished, or painted finish.

Model # 1
Armless



Model # 2
8 Angled Arm

Model # 3
10 Angled Arm



Model # 4
8 Angled Arm



Model # 5
10 Angled Arm



LOUNGE SEATING

The Berkley® Collection Designer - Nienkämper

– US Only –

Model Number	Seat H"	W"	D"	H"	Fabric Yds.	Leather Sq. Ft.	COM	COL	Neather	Verde	Grano	Cremoso	Knoll Textiles											
													1	2	3	4								
FOUR SEAT ELEMENT																								
	13405_16	96	35	27½																				
	/1 Armless with metal legs				6¼	100									6,415	6,885	7,180	10,640	11,755	12,210	7,130	7,630	8,220	8,785
	/2 8 Angled arm				8	128									7,390	7,930	8,450	13,295	14,880	15,490	8,310	8,945	9,700	10,425
	/3 10 Angled arm				8 ¾	140									7,570	8,100	8,610	13,465	15,025	15,625	8,570	9,270	10,100	10,885
	/4 8 Straight arm with leg				8	128									8,900	9,570	9,900	14,320	15,760	16,315	9,820	10,455	11,210	11,935
	/5 10 Straight arm with leg				8 ¾	140									8,970	9,640	9,960	14,395	15,825	16,375	9,970	10,670	11,500	12,285

Note: Width measurements do not include arms.

LARGE FOUR SEAT ELEMENT

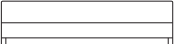
	13418_16	108	35	27½																					
	/1 Armless with metal legs				7	112									7,150	7,660	7,990	11,865	13,115	13,615	7,950	8,505	9,170	9,805	
	/2 8 Angled arm				8¾	140									8,120	8,730	9,295	14,550	16,255	16,920	9,120	9,820	10,650	11,435	
	/3 10 Angled arm				9 7/16	152									8,290	8,880	9,430	14,695	16,390	17,070	9,375	10,125	11,015	11,865	
	/4 8 Straight arm with leg				8¾	140									9,640	10,350	10,720	15,565	17,110	17,740	10,645	11,340	12,170	12,960	
	/5 10 Straight arm with leg				9½	152									9,695	10,425	10,785	15,615	17,180	17,800	10,785	11,540	12,440	13,295	

Note: Width measurements do not include arms.

Berkley Collection passes CAL 133 certified for an upcharge of \$1,755 list per 4 seat element, and \$1,975 per large 4 seat element. Certification applies to Nienkämper leathers and fabrics that have a minimum of 50% natural fibre content. COM's and COL's are subject to approval. Add the extension -CAL to the model number when ordering.

The Berkley Collection is a Nienkämper classic in its contemporary style and simplicity of line. This is a collection that is elegant yet generous in proportions. Berkley works well in public spaces, executive lounges, lobbies, and residences.

Frame:
Solid maple and plywood construction.

Seat and Back:
The seat and back are polyurethane foam covered in Fortrel®. Upholstered in leather or fabric. Yardages are for plain non-directional fabrics. Fabrics are railroaded.

Arms:
Two arm options are available, Angled and Straight. The Angled arm carries to the floor. The Straight arm rests on an aluminum base.

Base:
On models with Angled arms, the base is solid maple runners painted matte black. Aluminum bases are available in a brushed, polished, or painted finish.

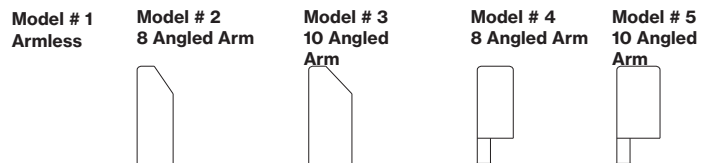

LOUNGE SEATING



The Berkley® Collection Designer – Nienkämper

– US Only –

Model Number	Seat H"	W"	D"	H"	Fabric Yds.	Leather Sq. Ft.	COM	COL	Neather	Verde	Grano	Cremoso	Knoll Textiles						
													1	2	3	4			
FIVE SEAT ELEMENT																			
	13419	16	120	35	27½														
/1 Armless with metal legs					7 ¾	139½	7,870	8,450	8,850	13,115	14,510	15,045	8,760	9,380	10,115	10,810			
/2 8 Angled arm					9 ½	152	8,860	9,520	10,115	15,785	17,615	18,340	9,950	10,705	11,605	12,460			
/3 10 Angled arm					10 ¼	164	9,000	9,680	10,270	15,930	17,780	18,505	10,175	10,995	11,960	12,890			
/4 8 Straight arm with leg					9 ½	152	10,380	11,150	11,550	16,820	18,505	19,170	11,475	12,230	13,125	13,985			
/5 10 Straight arm with leg					10 ¼	164	10,440	11,220	11,615	16,860	18,560	19,240	11,615	12,435	13,400	14,330			

Note: Width measurements do not include arms.

BENCH

	13411	16	48	24	16	2 ¼	32	2,335	2,485	2,565	3,690	4,015	4,165	2,595	2,775	2,985	3,190		
	13412	16	60	24	16	2 ¾	40	2,385	2,555	2,660	3,915	4,300	4,470	2,700	2,920	3,185	3,430		
	13413	16	72	24	16	3 ¼	48	2,785	2,995	3,090	4,475	4,925	5,090	3,160	3,420	3,725	4,020		
	13414	16	84	24	16	3 ¾	56	3,595	3,870	3,940	5,470	5,940	6,140	4,025	4,325	4,680	5,015		
	13415	16	96	24	16	4 ¼	64	3,805	4,070	4,165	5,825	6,355	6,555	4,290	4,635	5,030	5,415		

Note: Width measurements do not include arms.

Berkley Collection passes CAL 133 certified for an upcharge of \$2,195 list per 5 seat element, \$505 list per 48 bench, \$630 list per 60 bench, \$760 list per 72 bench, \$890 list per 84 bench, and \$1010 list per 96 bench. Certification applies to Nienkämper leathers and fabrics that have a minimum of 50% natural fibre content. COM's and COL's are subject to approval. Add the extension -CAL to the model number when ordering.

The Berkley Collection is a Nienkämper classic in its contemporary style and simplicity of line. This is a collection that is elegant yet generous in proportions. Berkley works well in public spaces, executive lounges, lobbies, and residences.

Frame:

Solid maple and plywood construction.

Seat and Back:

The seat and back are polyurethane foam covered in Fortrel®. Upholstered in leather or fabric. Yardages are for plain non-directional fabrics. Fabrics are railroaded.

Arms:

Two arm options are available, Angled and Straight. The Angled arm carries to the floor. The Straight arm rests on an aluminum base.

Base:

On models with Angled arms, the base is solid maple runners painted matte black. Aluminum bases are available in a brushed, polished, or painted finish.

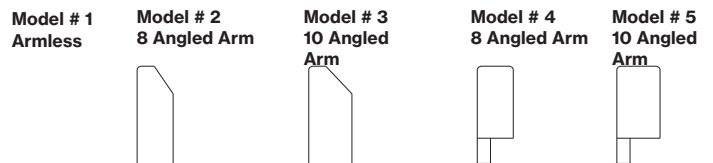

LOUNGE SEATING

The Berkley® Collection Designer - Nienkämper

– US Only –

Model Number	Seat H"	W"	D"	H"	Fabric Yds.	Leather Sq. Ft.	COM	COL	Neather	Verde	Grano	Cremoso	Knoll Textiles			
													1	2	3	4

LEFT CORNER ELEMENTS

One Seat Left Element																
13421_	16	23½-58½	35	27½												
/1	Armless with metal legs				4¼	68	3,915	4,200	4,445	6,775	7,570	7,845	4,400	4,745	5,140	5,525
/2	8 Angled arm				5	80	4,375	4,710	5,060	8,050	8,975	9,360	4,950	5,345	5,820	6,270
/3	10 Angled arm				5½	86	4,470	4,800	5,130	8,100	9,075	9,440	5,100	5,540	6,060	6,560
/4	8 Straight arm with leg				5	80	5,155	5,530	5,775	8,550	9,430	9,780	5,725	6,125	6,595	7,050
/5	10 Straight arm with leg				5½	86	5,185	5,575	5,805	8,570	9,450	9,805	5,815	6,255	6,775	7,275

Note: Width measurements do not include arms. One arm and one element must be specified with each element ordered

Two Seat Left Element																
13422_	16	47¼-82½	35	27½												
/1	Armless with metal legs				5¾	92	4,930	5,305	5,640	8,820	9,865	10,265	5,595	6,050	6,595	7,115
/2	8 Angled arm				6½	104	5,415	5,825	6,270	10,075	11,295	11,785	6,160	6,680	7,295	7,885
/3	10 Angled arm				7	110	5,505	5,920	6,350	10,140	11,375	11,860	6,310	6,865	7,525	8,160
/4	8 Straight arm with leg				6½	104	6,185	6,640	6,985	10,580	11,745	12,210	6,930	7,450	8,065	8,655
/5	10 Straight arm with leg				7	110	6,210	6,690	7,020	10,615	11,760	12,225	7,010	7,570	8,230	8,865

Note: Width measurements do not include arms. One arm and one element must be specified with each element ordered

Three Seat Left Element																
13423_	16	71½-106½	35	27½												
/1	Armless with metal legs				7¼	116	5,635	6,055	6,540	10,540	11,835	12,350	6,470	7,050	7,730	8,385
/2	8 Angled arm				8	128	6,135	6,585	7,160	11,795	13,280	13,885	7,055	7,690	8,445	9,170
/3	10 Angled arm				8½	134	6,205	6,665	7,230	11,865	13,155	13,950	7,180	7,855	8,660	9,425
/4	8 Straight arm with leg				8	128	6,885	7,405	7,870	12,315	13,720	14,295	7,805	8,440	9,195	9,920
/5	10 Straight arm with leg				8½	134	6,925	7,435	7,905	12,335	13,775	14,320	7,905	8,580	9,385	10,150

Note: Width measurements do not include arms. One arm and one element must be specified with each element ordered

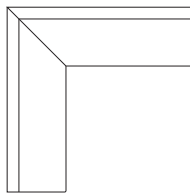
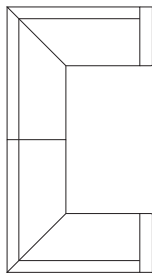

Model # 1
Armless

Model # 2
8 Angled Arm

Model # 3
10 Angled Arm

Model # 4
8 Angled Arm

Model # 5
10 Angled Arm



Yardages are for plain non-directional fabrics. Fabrics are railroaded. COM must be approved before placing an order.

LOUNGE SEATING

The Berkley® Collection Designer – Nienkämper

– US Only –

Model Number	Seat H"	W"	D"	H"	Fabric Yds.	Leather Sq. Ft.	Knoll Textiles											
							COM	COL	Neather	Verde	Grano	Cremoso	1	2	3	4		

RIGHT CORNER ELEMENTS



One Seat Right Element

Model #	Seat H"	W"	D"	H"	Fabric Yds.	Leather Sq. Ft.	COM	COL	Neather	Verde	Grano	Cremoso	1	2	3	4	
13424_	16	23½-58½	35	27 ½													
/1	Armless with metal legs				4 ¼	68	3,915	4,200	4,445	6,775	7,570	7,845	4,400	4,745	5,140	5,525	
/2	8 Angled arm				5	80	4,375	4,710	5,060	8,050	8,975	9,360	4,950	5,345	5,820	6,270	
/3	10 Angled arm				5 ½	86	4,470	4,800	5,130	8,100	9,075	9,440	5,100	5,540	6,060	6,560	
/4	8 Straight arm with leg				5	80	5,155	5,530	5,775	8,550	9,430	9,780	5,725	6,125	6,595	7,050	
/5	10 Straight arm with leg				5 ½	86	5,185	5,575	5,805	8,570	9,450	9,805	5,815	6,255	6,775	7,275	



Two Seat Right Element

Model #	Seat H"	W"	D"	H"	Fabric Yds.	Leather Sq. Ft.	COM	COL	Neather	Verde	Grano	Cremoso	1	2	3	4	
13425_	16	47½-82½	35	27 ½													
/1	Armless with metal legs				5 ¾	92	4,930	5,305	5,640	8,820	9,865	10,265	5,595	6,050	6,595	7,115	
/2	8 Angled arm				6 ½	104	5,415	5,825	6,270	10,075	11,295	11,785	6,160	6,680	7,295	7,885	
/3	10 Angled arm				7	110	5,505	5,920	6,350	10,140	11,375	11,860	6,310	6,865	7,525	8,160	
/4	8 Straight arm with leg				6 ½	104	6,185	6,640	6,985	10,580	11,745	12,210	6,930	7,450	8,065	8,655	
/5	10 Straight arm with leg				7	110	6,210	6,690	7,020	10,615	11,760	12,225	7,010	7,570	8,230	8,865	

Note: Width measurements do not include arms. One arm and one element must be specified with each element ordered



Three Seat Right Element

Model #	Seat H"	W"	D"	H"	Fabric Yds.	Leather Sq. Ft.	COM	COL	Neather	Verde	Grano	Cremoso	1	2	3	4	
13426_	16	71½-106½	35	27 ½													
/1	Armless with metal legs				7 ¼	116	5,635	6,055	6,540	10,540	11,835	12,350	6,470	7,050	7,730	8,385	
/2	8 Angled arm				8	128	6,135	6,585	7,160	11,795	13,280	13,885	7,055	7,690	8,445	9,170	
/3	10 Angled arm				8 ½	134	6,205	6,665	7,230	11,865	13,155	13,950	7,180	7,855	8,660	9,425	
/4	8 Straight arm with leg				8	128	6,885	7,405	7,870	12,315	13,720	14,295	7,805	8,440	9,195	9,920	
/5	10 Straight arm with leg				8 ½	134	6,925	7,435	7,905	12,335	13,775	14,320	7,905	8,580	9,385	10,150	

Note: Width measurements do not include arms. One arm and one element must be specified with each element ordered

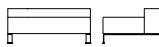

Bench w/8 Arm

Model #	Seat H"	W"	D"	H"	Fabric Yds.	Leather Sq. Ft.	COM	COL	Neather	Verde	Grano	Cremoso	1	2	3	4
13416		48	32	21 ½	4	72	5,050	5,295	5,470	7,380	8,145	8,395	5,510	5,825	6,205	6,565

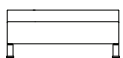

Bench w/10 Arm

Model #	Seat H"	W"	D"	H"	Fabric Yds.	Leather Sq. Ft.	COM	COL	Neather	Verde	Grano	Cremoso	1	2	3	4
13417		48	34	21 ½	4	72	5,125	5,375	5,530	7,440	8,220	8,480	5,590	5,905	6,280	6,645



Movable Cushion

Model #	Seat H"	W"	D"	H"	Fabric Yds.	Leather Sq. Ft.	COM	COL	Neather	Verde	Grano	Cremoso	1	2	3	4
13430		24	12	12	1	18	995	1,010	1,125	1,590	1,785	1,840	1,110	1,190	1,285	1,380

Model # 1
Armless



Model # 2
8 Angled Arm



Model # 3
10 Angled Arm



Model # 4
8 Angled Arm





Model # 5
10 Angled Arm

LOUNGE SEATING

Blob™ Designer - Karim Rashid

– US Only –

Model Number	Seat H"	W"	D"	H"	Fabric		COM	COL	Verde	Grano	Cremoso	Knoll Textiles						
					Yds.	Sq. Ft.						1	2	3	4			
BLOB																		
	1490_16	16	26	32 1/2	29													
	(Model #1)	Fully Upholstered				2 3/4	50	2,310	2,415	3,955	4,375	4,570	2,625	2,850	3,110	3,355		
	(Model #4)	Contrasting fabric			sides	1 1/2			2,310				2,625	2,850	3,110	3,355		
	(Model #5)	Contrasting leather		seat/back	1 1/2													
				sides	27				2,415	3,955	4,375	4,570						
				seat/back	27													
BLOB TWO SEAT SOFA																		
	14908	16	52	32 1/2	29													
		Fully Upholstered				4 3/4	86	4,125	4,340	6,415	7,010	7,255	4,670	5,050	5,500	5,925		
	14909	Contrasting fabric			sides	1 1/2			4,125				4,670	5,050	5,500	5,925		
	14910	Contrasting leather		seat/back	3 1/4													
				sides	27				4,340	6,415	7,010	7,255						
				seat/back	59													
BLOB THREE SEAT SOFA																		
	14921	16	78	32 1/2	29													
		Fully Upholstered				6 1/2	117	5,745	6,040	8,890	9,720	10,035	6,525	7,060	7,700	8,310		
	14922	Contrasting fabric			sides	1 1/2			5,745				6,525	7,060	7,700	8,310		
	14923	Contrasting leather		seat/back	5													
				sides	27				6,040	8,890	9,720	10,035						
				seat/back	90													

The curvaceous shape and soft molded foam of the Blob is conducive to fabrics with some stretch and minimum pattern.

When upholstered in two different fabrics or leathers, use the COM price and ship your fabric yardage or leather square footage to Nienkämper. See page 7 for COM and COL details.

Seams can have matching or contrasting stitching. Matching or contrasting welting detail can also be specified.

*For patterned or directional fabrics please contact Customer Service at 800.668.9318 for yardages.

Fabric to be upholstered on Blob requires approval from Nienkämper's factory. Please contact customer service at 800 668 9318 for our fabric approval list.

Model #14904
Contrasting fabric









Model #14904
Contrasting fabric



LOUNGE SEATING

Carlisle Designer - George Yabu & Glenn Pushelburg

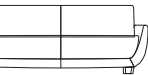
– US Only –

Model Number	Seat H"	Arm H"	W"	D"	H"	Fabric Yds.	Leather Sq. Ft.	COM	COL	Neather	Verde	Grano	Cremoso	Knoll Textiles				
														1	2	3	4	
CHAIR WITH SWIVEL DISK																		
	16200	16 ½	22	33	29	29												
	COM cushions & frame		1¾ yds		3¼ yds													
	Fully upholstered					4 ½	75	3,800	3,985	4,340	6,885	7,690	8,040	4,320	4,675	5,100	5,505	
	COM seat & back cushions, leather frame					1¾	53		3,985		5,980	6,550	6,775					
CHAIR WITH SWIVEL PEDESTAL BASE																		
	16240	19	24 ½	33	29	32												
	COM cushions & frame		1¾ yds		3¼ yds													
	Fully upholstered					4 ½	75	4,160	4,360	4,660	7,025	7,820	8,105	4,680	5,035	5,460	5,865	
	COM seat & back cushions, leather frame					1¾	53		4,360		6,020	6,505	6,700					
CHAIR WITH LEGS																		
	16210	16 ½	22	33	29	29												
	COM cushions & frame		1¾ yds		3¼ yds													
	Fully upholstered					4	70	3,985	4,280	6,665	7,435	7,715	4,260	4,575	4,955	5,315	5,060	
	COM seat & back cushions, leather frame					1¾	45	3,985		5,645	6,135	6,325						
TWO SEAT SOFA																		
	16220	16 ½	22	56 ⅝	29	29												
	COM cushions & frame		3½ yds		3¾ yds													
	Fully upholstered					7	104	6,555	6,885	7,435	10,855	11,985	12,440	7,360	7,915	8,575	9,210	
	COM seat & back cushions, leather frame					3 ½	63		6,885		9,170	9,855	10,125					
THREE SEAT SOFA																		
	16230	16 ½	22	79 ¾	29	29												
	COM cushions & frame		5¼ yds		5¼ yds													
	Fully upholstered					10	136	9,685	10,170	10,930	15,315	16,775	17,365	10,830	11,625	12,570	13,475	
	COM seat & back cushions, leather frame					5 ¼	81		10,170		13,045	13,915	14,270					
OTTOMAN																		
	16250	24 ½			20	16	1 ⅓	25	2,415	2,550	2,580	3,465	3,725	3,835	2,570	2,680	2,805	2,925

Carlisle series passes CAL 133 certified for an upcharge of \$550 list per chair, \$975 list per two seater sofa, \$1460 list per three seat sofa, and \$485 list per ottoman. Certification applies to Nienkämper leathers and fabrics that have a minimum of 50% natural fibre content. COM's and COL's are subject to approval. Add the extension -CAL to the model number when ordering.

Legs and swivel disk base are upholstered to match the frame.

Swivel pedestal base is in brushed nickel finish.

When upholstered in leather, the two seat sofa (model 16220) has a center seam. When upholstered in fabric, the two seat sofa (model 16220) does not have a center seam.

When upholstering in two different fabrics, use the COM price and ship yardages as noted on page 6.

Model #16200
Fully upholstered



Model #16240
Fully upholstered in Grano leather G7084 Basalt



LOUNGE SEATING

Dobi Designer – Nienkämper

– US Only –

Model Number	Seat H"	W"	D"	H"	Fabric Yds.	Leather Sq. Ft.	COM	COL	Verde	Grano	Cremoso	Knoll Textiles			
												1	2	3	4
11500	16	30	30	31	3	54	2,595	2,720	4,215	4,765	4,980	2,940	3,180	3,460	3,735

DOBI

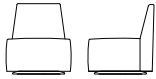

- Standard Features:**
- 360 degree swivel base
 - Foam has 20% soy content

**Model # 11500
Dobi Chair**



LOUNGE SEATING

Dune Metal Designer – Busk + Hertzog

– US Only –

Model Number	Seat H"	W"	D"	H"	Fabric Yds.	Leather Sq. Ft.	COM	COL	Neather	Verde	Grano	Cremoso	Knoll Textiles			
													1	2	3	4

DUNE CHAIR



10181	15¾	33	31½	28½	4	54	3,750	3,940	4,055	5,455	5,715	5,980	4,215	4,530	4,905	5,270
--------------	-----	----	-----	-----	---	----	-------	-------	-------	-------	-------	-------	-------	-------	-------	-------

DUNE 2 SEATER



10182	15¾	60½	31½	28½	6.5	117	6,185	6,495	6,835	9,775	10,335	10,905	6,930	7,450	8,065	8,655
--------------	-----	-----	-----	-----	-----	-----	-------	-------	-------	-------	--------	--------	-------	-------	-------	-------

DUNE 3 SEATER

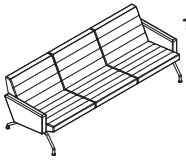

10183	15¾	88	31½	28½	10	180	8,610	9,045	9,605	14,070	14,950	15,825	9,755	10,555	11,500	12,405
--------------	-----	----	-----	-----	----	-----	-------	-------	-------	--------	--------	--------	-------	--------	--------	--------

Model # 10181
Dune Chair



Standard Features:

- Leg finish: mirror polish chrome, powder coat satin black

LOUNGE SEATING

Elite Designer - Nienkämper

Model Number	Seat H"	W"	D"	H"	Fabric		COM	COL	Neather	Verde	Grano	Cremoso	- US Only - Knoll Textiles			
					Yds.	Sq. Ft.							1	2	3	4

ELITE CHAIR WITH FIXED BASE

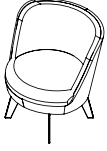

15411	17	28	27½	30	2¾	50	3,525	3,710	3,820	5,170	5,440	5,575	3,840	4,060	4,325	4,570
-------	----	----	-----	----	----	----	-------	-------	-------	-------	-------	-------	-------	-------	-------	-------

ELITE CHAIR WITH SWIVEL BASE

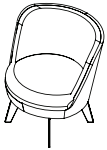

15412	17	28	27½	31¼	2¾	50	4,200	4,370	4,480	5,835	6,110	6,235	4,515	4,740	5,000	5,245
-------	----	----	-----	-----	----	----	-------	-------	-------	-------	-------	-------	-------	-------	-------	-------

Model # 15411



Standard Features:

- Interior clearance of the seat is 24"W x 20"D
- Back with 2" thick lumbar foam wedge
- Swivel base is standard with 180 degree swivel and memory return
- Steel base is standard in Silver powder coat PC-01 or Black powder coat PC-06

GATEWAY™ LOUNGE

UPHOLSTERED LOUNGE ELEMENTS

Design - busk + hertzog

Upholstered Lounge Elements:

Dimensions:

- 10 basic upholstered elements make up the Gateway Lounge system.
- Convex bench element for sofa: 40" w x 24 1/2" d x 17" h
- Convex sofa element: 40" w x 29 1/2" d x 32" h
- Convex symmetric bench element: 40" w x 24 1/2" d x 17" h
- Concave bench element for sofa: 41" w x 24 1/2" d x 17" h
- Concave sofa element: 41" w x 29 1/2" d x 32" h
- Concave symmetric bench element: 40" w x 24 1/2" d x 17" h
- Straight bench for sofa element: 28" w x 24 1/2" d x 17" h
- Straight sofa element: 28" w x 24 1/2" d x 32" h
- Straight symmetric bench element: 28" w x 24 1/2" d x 17" h
- 120° corner sofa element: 28" -48" w x 29 1/2" d x 32" h

Fabrics:

Gateway Lounge elements are available in a range of both solid matching pattern and colors and contrasting combinations. COM is also acceptable in most cases (contact customer service for details).



Accessories:

Privacy Screens:

- Low and tall height integrated screens offer privacy and sound dampening to any convex, concave, straight & 120° corner sofa element.
- 120° corner sofa element standard has only one side with privacy screen, contact Customer Service if you require both sides with privacy screen.

Dimensions:

- Low height privacy screen: 34" h (for screen only), overall height with sofa is 44" h including 10" h overhang from floor.
- Tall height privacy screen: 49" h (for screen only), overall height with sofa is 59" h including 10" h overhang from floor.

Fabrics:

- Gateway Lounge Privacy Screens are available in COM and Knoll Textiles fabrics.



Screen Table:

- An optional, shallow 9" deep curved or straight table can be added to the low height privacy screen to allow for tiered seating and table top behind the sofa.
- 120° corner sofa element standard has only one side with screen table, contact Customer Service if you require both sides with screen table.

Dimensions:

- Convex/Concave Element: 42 1/2" w x 9" d x 3/4" thick
- Straight/120° Corner Element (one side only): 28" w x 9" d x 3/4" thick

Finishes:

Top is 3/4" thick with self edge available in Nienkämper standard veneers and finishes as well as plastic laminates.

Round Sofa Table:

A round table (14" dia) can also be added to any Gateway Lounge element, mounting to either front or back of the sofa or bench. The mounting bracket is silver powder coated finish as standard, other powder coat colors and chrome finish are also available with upcharge.

Dimensions: 14" dia x 3/4" thick

Finishes: Tops are 3/4" thick with self edge available in Nienkämper standard veneers and finishes as well as plastic laminates



GATEWAY™ LOUNGE ELEVATION

Gateway Lounge Elements with Accessories

Side elevation shows Gateway Sofa with low height screen & 9" deep top

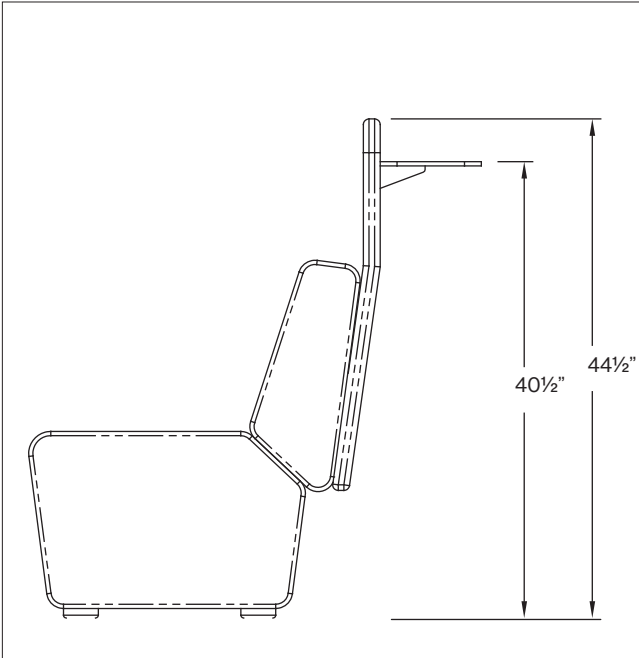

Side elevation shows Gateway Sofa with round table mounted to back

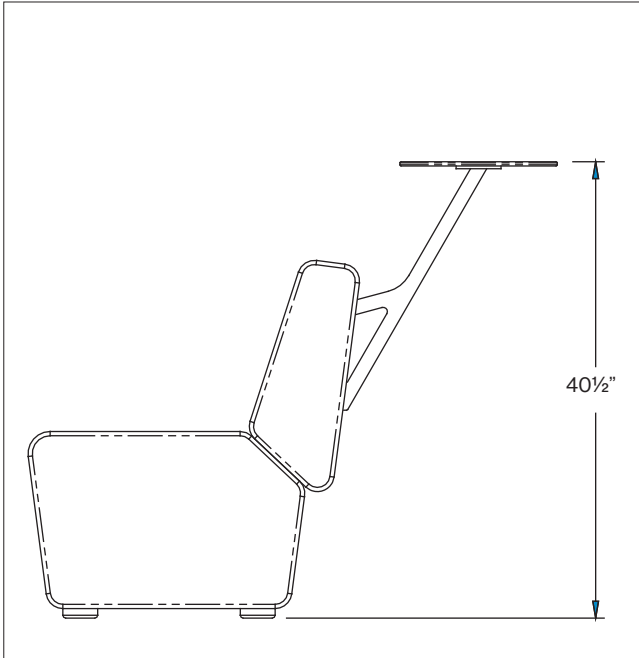

Side elevation shows Gateway Sofa with round table mounted to front

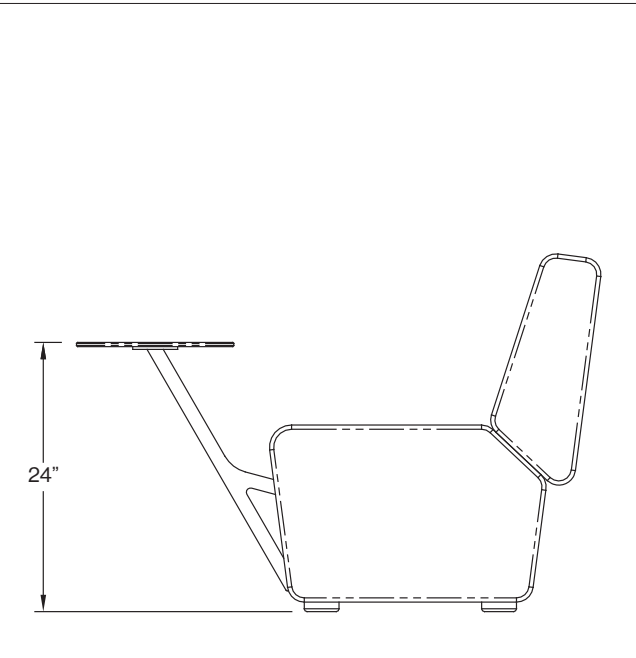

Side elevation shows Gateway Sofa with tall height screen

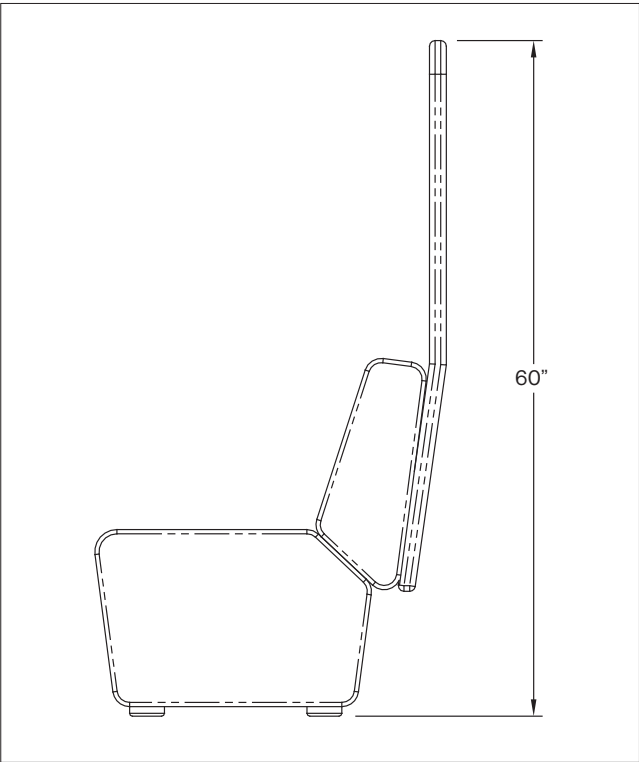

GATEWAY™ LOUNGE LAYOUT

Gateway Lounge Elements Configuration

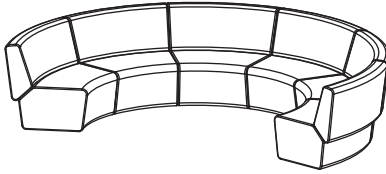
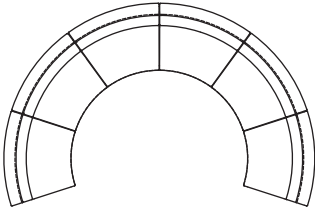

6 concave sofa elements

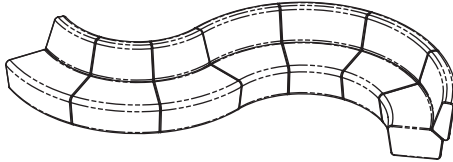
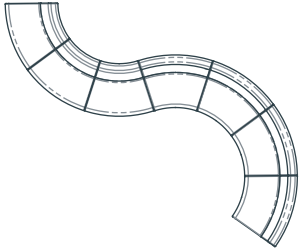

3 convex sofa elements
4 concave sofa elements

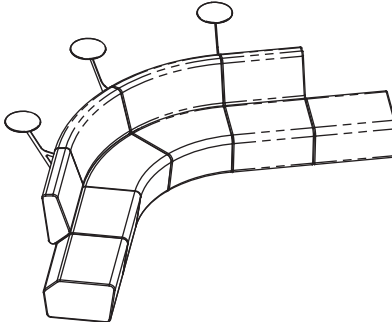
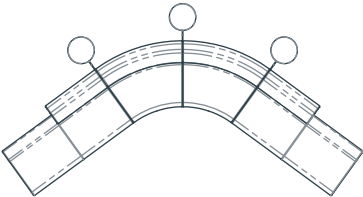

2 concave sofa elements
2 straight sofa elements
2 straight bench elements
3 round sofa tables

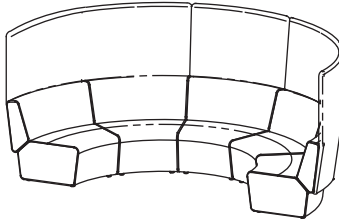
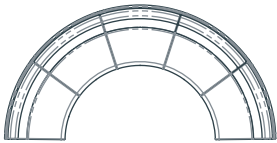

5 convex sofa elements
5 concave sofa elements

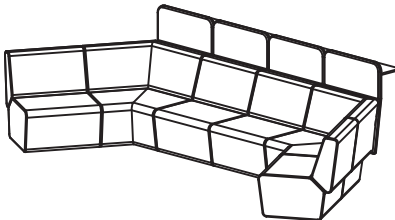
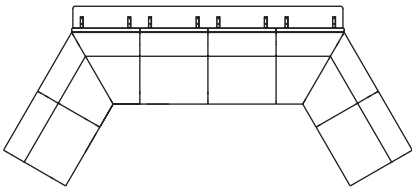







4 straight sofa elements
2 120 degree corner sofa elements
4 straight low screen with 9" deep top

GATEWAY™ LOUNGE ELEMENTS

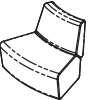
SOFA ELEMENTS

— US ONLY —

	Model Number	Seat		D"	H"	Fabric		COM	COL	Verde	Grano	Cremoso	Knoll Textiles						
		H"	W"			Yrds.	Sq. Ft.						1	2	3	4			
CONVEX																			
SYMMETRIC BENCH ELEMENT																			
	11410	17	40	24 ⁵ / ₈	17	2 ¹ / ₄	108												
								2,590	2,720	3,685	3,940	4,340	2,855	3,030	3,240	3,445			
BENCH ELEMENT FOR SOFA																			
	11411	17	40	24 ⁵ / ₈	17	2 ¹ / ₄	108												
								2,590	2,720	3,685	3,940	4,340	2,855	3,030	3,240	3,445			
SOFA ELEMENT																			
	11412	17	40	29 ¹ / ₂	32	4 ¹ / ₂	108												
								4,595	4,830	6,755	7,280	8,070	5,115	5,475	5,900	6,300			
CONCAVE																			
SYMMETRIC BENCH ELEMENT																			
	11420	17	28	24 ⁵ / ₈	17	2	108												
								2,590	2,720	3,685	3,940	4,340	2,855	3,030	3,240	3,445			
BENCH ELEMENT FOR SOFA																			
	11413	17	28	24 ⁵ / ₈	17	2 ¹ / ₄	108												
								2,590	2,720	3,685	3,940	4,340	2,855	3,030	3,240	3,445			
SOFA ELEMENT																			
	11414	17	41	29 ¹ / ₂	32	4 ¹ / ₂	108												
								4,595	4,830	6,755	7,280	8,070	5,115	5,475	5,900	6,300			

Features:

- Gateway™ upholstered lounge elements include linear and curved modular components which enable the customer to create their own solution.
- Element styles are bench, sofa and sofa with integrated privacy screen.







GATEWAY™ LOUNGE ELEMENTS

SOFA ELEMENTS

— US ONLY —

KnollTextiles

Model Number	Seat H"	W"	D"	H"	Fabric Yrds.	Leather Sq. Ft.	COM	COL	Verde	Grano	Cre moso	1	2	3	4	
STRAIGHT																
SYMMETRIC BENCH ELEMENT																
	11417	17	28	24 ⁵ / ₈	17	2 ¹ / ₄	108									
								2,465	2,490	3,520	3,805	4,180	2,725	2,905	3,115	3,320
BENCH ELEMENT FOR SOFA																
	11415	17	28	24 ⁵ / ₈	17	2 ¹ / ₄	108									
								2,465	2,490	3,520	3,805	4,180	2,725	2,905	3,115	3,320
SOFA ELEMENT																
	11416	17	28	29 ¹ / ₂	32	4 ¹ / ₂	108									
								4,460	4,685	6,600	7,150	7,895	4,980	5,335	5,760	6,165
120 DEGREE																
BENCH ELEMENT FOR SOFA																
	11418		34	37 ³ / ₄	17	5	216									
								4,910	4,965	7,030	7,590	2,590	5,485	5,880	6,355	6,805
SOFA ELEMENT																
	11419		38 ³ / ₄	31 ³ / ₄	32	9	216									
								8,900	9,345	13,195	14,290	15,780	9,935	10,650	11,500	12,315

Features:







- Gateway™ upholstered lounge elements include linear curved and corner modular components which enable the customer to create their own solution.
- Element styles are bench, sofa and sofa with integrated privacy screen.

GATEWAY™ LOUNGE ELEMENTS

SOFA ELEMENTS

— US ONLY —

KnollTextiles

Model Number	Seat H"	W"	D"	H"	Fabric Yrds.	Leather Sq. Ft.	COM	COL	Verde	Grano	Cremoso	1	2	3	4
PRIVACY SCREEN															
CONVEX															
	11421	Tall Height	42½	59	3	54	1,650	1,730	3,085	3,440	3,870	1,995	2,235	2,515	2,790
	11422	Low Height	42½	44	2	36	1,360	1,425	2,310	2,555	2,855	1,595	1,750	1,940	2,125
	11423	Low Height with 9" deep shelf	42½	44	2	36	1,940	2,040	2,920	3,165	3,475	2,170	2,330	2,515	2,700
CONCAVE															
	11424	Tall Height	42½	59	3	54	1,650	1,730	3,085	3,440	3,870	1,995	2,235	2,515	2,790
	11425	Low Height	42½	44	2	36	1,360	1,425	2,310	2,555	2,855	1,595	1,750	1,940	2,125
	11426	Low Height with 9" deep top	42½	44	2	36	1,940	2,040	2,920	3,165	3,475	2,170	2,330	2,515	2,700
STRAIGHT (for straight or 120° corner element)															
	11427	Tall Height	28	59	3	54	1,195	1,255	2,610	2,955	3,430	1,540	1,775	2,060	2,335
	11428	Low Height	28	44	2	36	1,080	1,135	2,035	2,260	2,580	1,310	1,465	1,655	1,840
	11429	Low Height with 9" deep top	28	44	2	36	1,490	1,560	2,465	2,685	3,000	1,720	1,875	2,065	2,250
ROUND SOFA TABLE															
	11431		14 dia.				1,505								

Feature:

- Privacy screens can be contrasting or matching fabrics
- Table top is ¾" thick Self edge available in Nienkämper veneers & P-lam.

LOUNGE SEATING

Godbout Designer – Charles Godbout

– US Only –

Model Number	Seat H"	Arm H"	W"	D"	H"	Fabric Yds.	Leather Sq. Ft.	COM	COL	Verde	Grano	Cremoso	Knoll Textiles			
													1	2	3	4

LOUNGE CHAIR

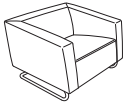

12201	14	22½	33	30	25¼	4	75	5,205	5,475	7,715	8,440	8,705	5,665	5,980	6,360	6,720
-------	----	-----	----	----	-----	---	----	-------	-------	-------	-------	-------	-------	-------	-------	-------

TWO SEAT SOFA

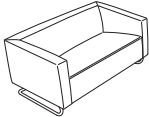

12202	14	22½	56	30	25¼	6	110	6,395	6,730	10,110	11,150	11,545	7,085	7,560	8,130	8,675
-------	----	-----	----	----	-----	---	-----	-------	-------	--------	--------	--------	-------	-------	-------	-------

THREE SEAT SOFA

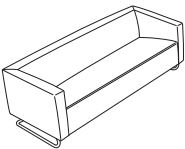

12203	14	22½	82	30	25¼	7½	140	7,700	8,095	12,435	13,750	14,265	8,560	9,160	9,865	10,545
-------	----	-----	----	----	-----	----	-----	-------	-------	--------	--------	--------	-------	-------	-------	--------

Standard Features:

- Plywood frame construction
- Seat and back are webbed
- Polyurethane foam
- Fortrel® on seat, back and arms
- Reinforced tubular steel base in chrome powder coat finish

Model # 12201



LOUNGE SEATING

Heartbeat Designer - Karim Rashid

– US Only –

Model Number	Seat H"	Arm H"	W"	D"	H"	Fabric Yds.	COM	Knoll Textiles			
								1	2	3	4

HEARTBEAT CONVEX ELEMENT



10401	17		51	37 ³ / ₄	31 ¹ / ₂	5 ¹ / ₂	4,720	5,350	5,795	6,315	6,810
-------	----	--	----	--------------------------------	--------------------------------	-------------------------------	-------	-------	-------	-------	-------

HEARTBEAT CONCAVE ELEMENT

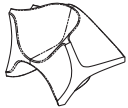

10402	17		54 ¹ / ₄	32	31 ¹ / ₂	5 ¹ / ₂	4,720	5,295	5,695	6,165	6,615
-------	----	--	--------------------------------	----	--------------------------------	-------------------------------	-------	-------	-------	-------	-------

HEARTBEAT STRAIGHT ELEMENT

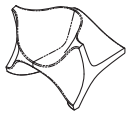

10403	17		40	35	31 ¹ / ₂	5 ¹ / ₂	4,490	5,120	5,560	6,080	6,580
-------	----	--	----	----	--------------------------------	-------------------------------	-------	-------	-------	-------	-------

HEARTBEAT CONVEX TABLE ELEMENT

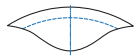

	Finish	W"	D"	Thick-ness"	
10404/2	Veneer	35 ⁵ / ₁₆	12 ³ / ₈	1 ¹ / ₄	1,460
10404/5	P-Lam	35 ⁵ / ₁₆	12 ³ / ₈	1 ¹ / ₄	1,300

HEARTBEAT CONCAVE TABLE ELEMENT

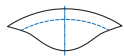

10405/2	Veneer	32 ⁹ / ₁₆	11 ¹³ / ₁₆	1 ¹ / ₄	1,460
10405/5	P-Lam	32 ⁹ / ₁₆	11 ¹³ / ₁₆	1 ¹ / ₄	1,300

Standard Features:

- Rigid core frame with durable foam cover.
- Convex/Concave/Straight sofa elements can be arranged in limitless quantity and configuration to create double sided seating.
- Optional Convex/Concave table element with 3" taper edge mounts between sofa elements to frame with metal support.
- Optional dual USB Charger can be added to underside of table.

Note:

Fabric with 4 way stretch is recommended on Heartbeat chair, COM should be approved by Nienkämper factory.



LOUNGE SEATING

Heartbeat Designer - Karim Rashid

- US Only -

Heartbeat Layout

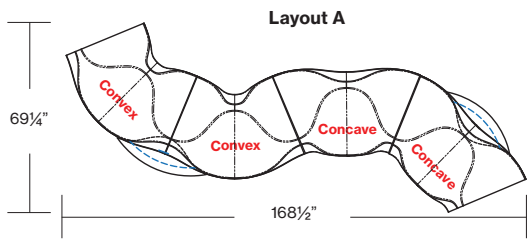
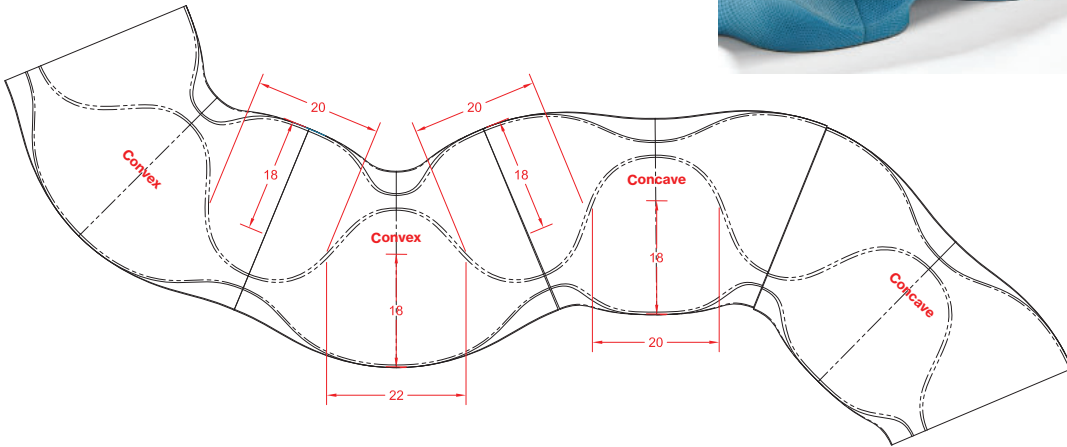

Layout "A" consists of:
 4 Sofa Elements & 2 Table Elements providing a total of 7 Seats
 From left to right: Convex Sofa Element #10401, Convex Table Element #10404/5, Convex Sofa Element #10401, Concave Sofa Element #10402, Concave Sofa Element #10402, Concave Table Element #10405/5

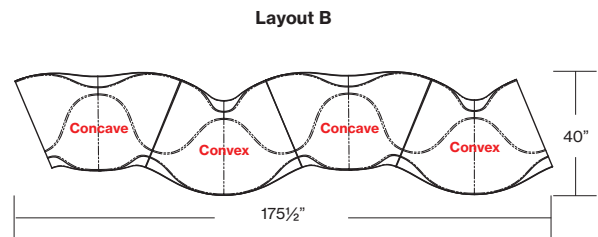

Layout "B" consists of:
 4 Sofa Elements providing a total of 7 Seats
 From left to right: Concave Sofa Element #10402, Convex Sofa Element #10401, Concave Sofa Element #10402, Convex Sofa Element #10401

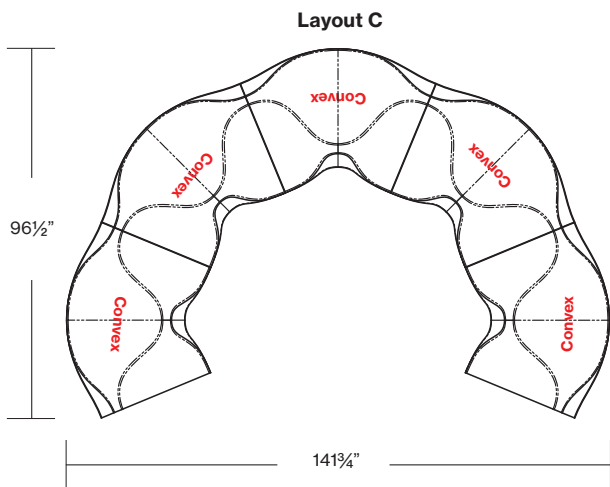

Layout "C" consists of:
 5 Sofa Elements providing a total of 9 Seats
 From left to right: Convex Sofa Element #10401, Convex Sofa Element #10401, Convex Sofa Element #10401, Convex Sofa Element #10401, Convex Sofa Element #10401

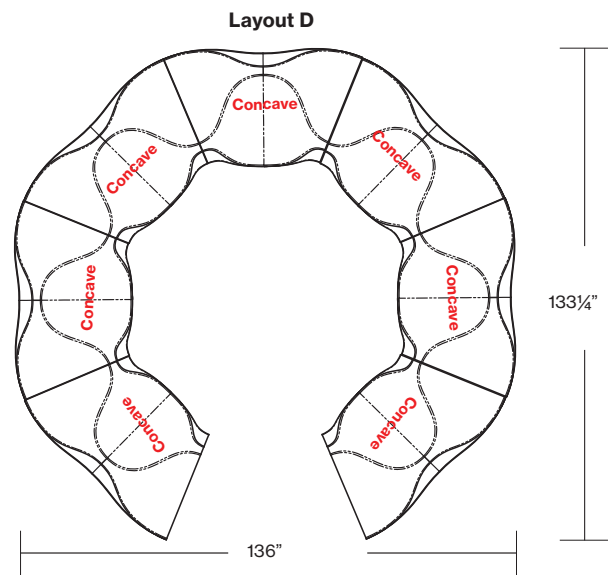

Layout "D" consists of:
 7 Sofa Elements providing a total of 13 Seats
 From left to right: Concave Sofa Element #10402, Concave Sofa Element #10402, Concave Sofa Element #10402, Concave Sofa Element #10402, Concave Sofa Element #10402, Concave Sofa Element #10402, Concave Sofa Element #10402

LOUNGE SEATING

Isola 8 Designer – Karim Rashid

– US Only –

Model Number	Seat H"	W"	D"	H"	Fabric Yds.	Leather Sq. Ft.	COM	COL	Verde	Grano	Cremoso	Knoll Textiles			
												1	2	3	4

ISOLA 8

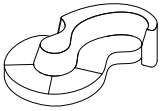

10210

Fully	16	110	70	32	15 ½	126
Back					8 ½	153
Seat					7	280

16,190	17,010	24,560	27,340	28,280	17,965	19,200	20,665	22,070
--------	--------	--------	--------	--------	--------	--------	--------	--------

Frame:

- Birch plywood .

Seat and Back:

- Soy based foam and Fortrel.

Base:



- Painted Mdf Base.



LOUNGE SEATING

J + J Studio Sofa Designer - MSDS Studio

– US Only –

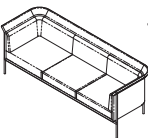
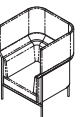
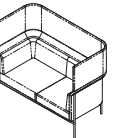
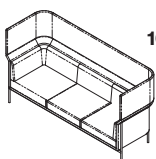
Model Number	Seat H"	W"	D"	H"	Fabric		Leather		COM				Knoll Textiles					
					Yds.	Sq. Ft.	COL	Neather	Verde	Grano	Cremoso	1	2	3	4			
J + J STUDIO LOW BACK LOUNGE CHAIR																		
	10271	17	35	30 3/4	33	Fully upholstered	6	108	5,425	5,700	6,045	8,855	9,430	9,715	6,115	6,590	7,160	7,705
						COM cushions, leather frame	3	52		5,700		7,270	7,575	7,705				
J + J STUDIO LOW BACK 2 SEAT SOFA																		
	10272	17	59	30 3/4	33	Fully upholstered	8 1/2	153	7,920	8,320	8,790	12,790	13,610	14,025	8,895	9,575	10,375	11,145
						COM cushions, leather frame	4 1/4	75		8,320		10,570	10,985	11,185				
J + J STUDIO LOW BACK 3 SEAT SOFA																		
	10273	17	85	30 3/4	33	Fully upholstered	11 3/4	212	9,550	10,025	10,750	16,230	17,355	17,910	10,900	11,835	12,950	14,010
						COM cushions, leather frame	6 3/4	90		10,025		12,660	13,140	13,380				
J + J STUDIO HIGH BACK LOUNGE CHAIR																		
	10275	17	35	30 3/4	49	Fully upholstered	8 1/4	149	6,520	6,825	7,365	11,185	11,985	12,375	7,465	8,125	8,900	9,645
						COM cushions, leather frame	3	95		6,825		9,605	10,115	10,365				
J + J STUDIO HIGH BACK 2 SEAT SOFA																		
	10276	17	59	30 3/4	49	Fully upholstered	11 1/2	207	9,510	9,975	10,685	16,030	17,130	17,680	10,830	11,745	12,835	13,875
						COM cushions, leather frame	4 1/4	130		9,975		13,780	14,470	14,805				
J + J STUDIO HIGH BACK 3 SEAT SOFA																		
	10277	17	85	30 3/4	49	Fully upholstered	15 1/4	275	11,455	12,030	13,010	20,080	21,540	22,260	13,200	14,420	15,855	17,240
						COM cushions, leather frame	6 3/4	153		12,030		16,510	17,320	17,715				

Standard Features:

- Solid maple and plywood construction frame wrapped with foam
- Seat and back cushions have molded foam inside and wrapped in Dacron.
- Exposed steel frame available in clear coated raw finish, polished chrome, brushed chrome and black powder coat finish.

Model # 10277 J + J Studio high back 3 seat sofa



Model # 10273 J + J Studio low back 3 seat sofa



Frame upholstered in Ecopell leather, Blueberry EC700

LOUNGE SEATING

Kloud® Designer – Karim Rashid

– US Only –

Model Number	Seat Arm		W"	D"	H"	Fabric Leather		COM	COL	Verde	Grano	Cremoso	Knoll Textiles			
	H"	H"				Yds.	Sq. Ft.						1	2	3	4

CHAIR



Fully upholstered 14981	17	24½	38	28 ½	31	4 ½	81	3,265	3,430	5,925	6,630	6,910	3,780	4,140	4,565	4,970
-----------------------------------	----	-----	----	------	----	-----	----	-------	-------	-------	-------	-------	-------	-------	-------	-------

TWO SEAT SOFA

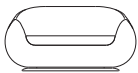

Fully upholstered 14984	17	24½	63	28 ½	31	6	108	5,645	5,925	9,015	10,210	11,000	6,335	6,810	7,380	7,925
-----------------------------------	----	-----	----	------	----	---	-----	-------	-------	-------	--------	--------	-------	-------	-------	-------

THREE SEAT SOFA

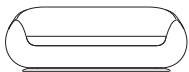

Fully upholstered 14987	17	24½	86	28 ½	31	7 ½	135	8,340	8,760	12,650	14,170	14,975	9,200	9,800	10,510	11,185
-----------------------------------	----	-----	----	------	----	-----	-----	-------	-------	--------	--------	--------	-------	-------	--------	--------

Kloud Collection passes CAL 133 certified for an upcharge of \$550 list per chair, \$975 list per 2 seat sofa and \$1,460 list per 3 seat sofa. Certification applies to Nienkämper leathers and fabrics that have a minimum of 50% natural fibre content. COM's and COL's are subject to approval. Add the extension -CAL to the model number when ordering.

Laminated wood base frame with rubber webbing under the fixed cushion. The foam body is supported with a tubular steel frame inside.

The seat and back are polyurethane foam covered in Fortrel®. Upholstered in leather or fabric.

The swivel base is painted silver. The swivel base can be upholstered to match the frame;
 add ⅔ yds 6 sq. ft. chair
 add ⅔ yds 12 sq. ft. two seat sofa
 add 1⅓ yds 18 sq. ft. three seat sofa





The curvaceous shape and soft molded foam of the Kloud chair are conducive to fabrics with some stretch and minimum pattern. COM fabrics should be approved by customer service. (800.668.9318)

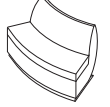
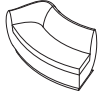

LOUNGE SEATING

Kloud® Serpentine™ Designer – Karim Rashid

– US Only –

	Model Number	Seat H"	Arm H"	W"	D"	H"	Fabric Yds.	Leather Sq. Ft.	COM	COL	Verde	Grano	Cremoso	Knoll Textiles			
														1	2	3	4
CONVEX																	
Right end	14994	17	25 ¾	73	28 ½	30 ½	6 ¾	122	5,280	5,530	9,105	10,535	10,975	6,055	6,590	7,230	7,840
																	
Centre element	14991	17		54	28 ½	30 ½	4 ¾	86	3,490	3,665	6,190	7,205	7,500	4,035	4,410	4,865	5,290
																	
Left end	14993	17	25 ¾	73	28 ½	30 ½	6 ¾	122	5,280	5,530	9,105	10,535	10,975	6,055	6,590	7,230	7,840
																	
CONCAVE																	
Right end	14997	17	25 ¾	67	28 ½	30 ½	7	126	5,610	5,880	9,570	11,040	11,490	6,415	6,970	7,630	8,265
																	
Centre element	14992	17		52	28 ½	30 ½	5	90	3,855	4,055	6,705	7,740	8,080	4,430	4,825	5,300	5,750
																	
Left end	14996	17	25 ¾	67	28 ½	30 ½	7	126	5,610	5,880	9,570	11,040	11,490	6,415	6,970	7,630	8,265
																	
STRAIGHT	14995	17		24	28 ½	30 ½	2 ½	45	3,220	3,375	3,960	4,245	4,340	3,510	3,710	3,945	4,170
																	

Frame:

Laminated wood base frame with rubber webbing under the fixed cushion. The foam body is supported with a tubular steel frame inside.

Seat and Back:

The seat and back are polyurethane foam, seat covered in Fortrel®. Upholstered in leather or fabric.

Base:

The base is painted silver.

The curvaceous shape and soft molded foam of the Kloud chair are conducive to fabrics with some stretch and minimum pattern. COM fabrics should be approved by customer service. (800.668.9318)

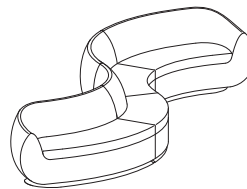

Consists of (from Left to Right when facing) :

- 1 x **14993** Convex Left End
- 1 x **14991** Convex Centre Element
- 1 x **14992** Concave Centre Element
- 1 x **14997** Concave Right End

LOUNGE SEATING

Leaf Designer - Busk + Hertzog

– US Only –

Model Number	Seat H"	Arm H"	W"	D"	H"	Fabric Yds.	Leather Sq. Ft.	COM	COL	Neather	Verde	Grano	Cremoso	Knoll Textiles			
														1	2	3	4

LEAF CHAIR



10310	17		36½	28	25¼	2½	45	3,585	3,745	3,810	4,830	5,055	5,160	3,870	4,070	4,305	4,535
-------	----	--	-----	----	-----	----	----	-------	-------	-------	-------	-------	-------	-------	-------	-------	-------

Model # 10310



Standard Features:

- Seat with plywood shell
- Soy based flexible polyurethane foam for seat & back
- Polished chrome base

Fabric to be upholstered on Leaf Chair needs to be approved by Nienkämper Factory, please contact Customer Service at 800 668 9318 for our fabric approval list.



LOUNGE SEATING

Nordic Designer - Nienkämper

– US Only –

Model Number	Seat H"	W"	D"	H"		Fabric		COM	COL	Neather	Verde	Grano	Cremoso	Knoll Textiles			
						Yds.	Sq. Ft.							1	2	3	4

NORDIC



10262	16½	28	26	29½	2	36			3,400	3,570	3,610	4,595	4,800	4,910	3,630	3,790	3,975	4,160
-------	-----	----	----	-----	---	----	--	--	-------	-------	-------	-------	-------	-------	-------	-------	-------	-------

Model # 10262



Standard Features:

- Molded plywood frame
- Seat and back cushions with polyurethane foam
- Base is beech plywood available in natural finish and standard Nienkämper paint finish
- Custom stained to match on the base is also available with upcharge

LOUNGE SEATING

Note Designer - Busk + Hertzog

– US Only –

Model Number	Seat Arm		W"	D"	H"	Fabric Leather		COM	COL	Neather	Verde	Grano	Cremoso	Knoll Textiles			
	H"	H"				Yds.	Sq. Ft.							1	2	3	4

NOTE CHAIR ON GLIDES

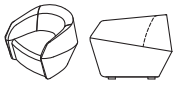

10651 16 25¼ 33 34½ 27¾ 5½ 99

4,125 4,335 4,680 7,105 7,585 8,065 4,755 5,195 5,715 6,215

NOTE CHAIR WITH SWIVEL DISK

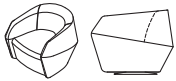

10654 16 25¼ 33 34½ 27¾ 6½ 113

4,460 4,685 5,110 7,845 8,395 8,950 5,205 5,725 6,340 6,925

NOTE TWO SEAT SOFA

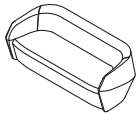

10652 16 25¼ 69 34½ 27¾ 8½ 153

5,595 5,875 6,445 10,155 10,900 11,640 6,570 7,245 8,050 8,815

NOTE THREE SEAT SOFA

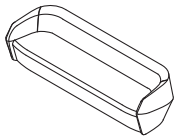

10653 16 25¼ 93 34½ 27¾ 9½ 171

7,000 7,350 7,950 12,130 12,965 13,805 8,095 8,850 9,745 10,600

Standard Features:

- Frame is constructed of hardwood, plywood and soy based polyurethane foam.
- Note chair is available on glides or with swivel disk in upholstery finish.
- Contrasting stitching can be specified on outside back with no upcharge.

Optional contrast stitching on outside back:

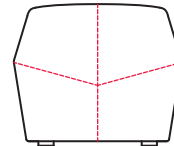

Back Elevation

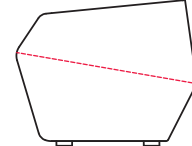

Side Elevation

Model # 10651
Note chair



Model # 10652
Note two seat sofa



Model # 10651 & 10653
Note chair & three seat sofa with Mint Stools

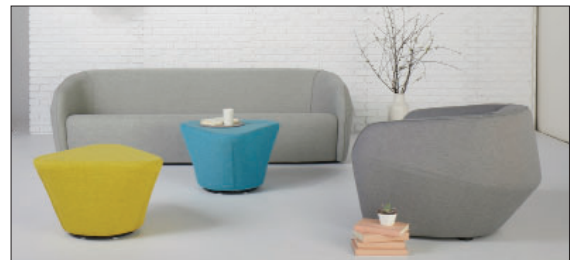

LOUNGE SEATING

Radius Designer - Christopher Panichella

– US Only –

Model Number	Seat Arm			D"	H"	Fabric Yds.	Leather Sq. Ft.	COM	COL	Neather	Verde	Grano	Cremoso	Knoll Textiles			
	H"	H"	W"											1	2	3	4

RADIUS LOW BACK - WITH WOOD BACK



10770	16	27	33¼	33	29	3½	63	6,420	6,670	6,520	8,590	8,960	9,135	6,820	7,100	7,430	7,745
-------	----	----	-----	----	----	----	----	-------	-------	-------	-------	-------	-------	-------	-------	-------	-------

RADIUS LOW BACK - FULLY UPHOLSTERED

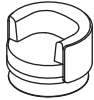

10771	16	27	33¼	33	29	4½	81	5,035	5,290	5,530	7,750	8,225	8,470	5,555	5,915	6,340	6,745
-------	----	----	-----	----	----	----	----	-------	-------	-------	-------	-------	-------	-------	-------	-------	-------

RADIUS HIGH BACK

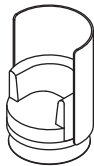

10772	16	27	33¼	33	48	6¾	122	7,930	8,335	8,675	12,065	12,765	13,115	8,705	9,240	9,885	10,490
-------	----	----	-----	----	----	----	-----	-------	-------	-------	--------	--------	--------	-------	-------	-------	--------

ACCESSORIES

TABLET ARM



12461			20	12	½			1,665									
-------	--	--	----	----	---	--	--	-------	--	--	--	--	--	--	--	--	--

CUP HOLDER



10774			4 dia					680									
-------	--	--	-------	--	--	--	--	-----	--	--	--	--	--	--	--	--	--

POWER

Simple Dot Forums



White receptacle, model #11867/W \$315 list



White stacked USB, model #11868/W \$545 list



Black receptacle, model #11967/B \$315 list



Black stacked USB, model # 11868/B \$545 list

Model # 10770
Radius low back
with wood back



Radius low back upholstered in Ecopell leather Blackberry EC100

Model # 10772
Radius high back with
tablet, cup holder & power



Standard Features:

- Seat depth: 22"d
- Seat and back cushions have a foam core with Dacron wrap.
- Disk base standard in brushed finish.
- Radius Low Back chair is available with wood back on exterior. Select from standard Nienkämper veneer & stains.
- Radius High Back chair is only available fully upholstered.

Optional Features:

- Tablet top available in pure White or Black ½" thick Fingerprint Resistance solid material.
- Tablet arm support in silver or white powder coat finish
- Cup holder available in polished or brushed aluminum.
- Cup holder top with leather or vinyl inset in white or black as standard.
- Power Outlet or stacked USB Charger with 72" cord in white or black finish.



Tablet arm available in white or silver finish

LOUNGE SEATING

Radius on Legs Designer - Christopher Panichella

– US Only –

Model Number	Seat Arm		W"	D"	H"	Fabric Yds.	Leather Sq. Ft.	COM	COL	Neather	Verde	Grano	Cremoso	Knoll Textiles			
	H"	H"												1	2	3	4

RADIUS LOW BACK - WITH WOOD BACK

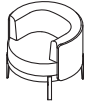

10775	16	28¼	33½	32¾	28¼	3½	63	6,280	6,535	6,360	8,450	8,810	9,000	6,685	6,965	7,295	7,610
-------	----	-----	-----	-----	-----	----	----	-------	-------	-------	-------	-------	-------	-------	-------	-------	-------

RADIUS LOW BACK - FULLY UPHOLSTERED



10776	16	28¼	33½	32¾	28¼	4½	81	4,900	5,145	5,385	7,625	8,085	8,325	5,420	5,775	6,205	6,605
-------	----	-----	-----	-----	-----	----	----	-------	-------	-------	-------	-------	-------	-------	-------	-------	-------

RADIUS HIGH BACK

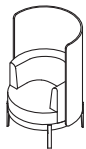

10777	16	28¼	33½	32¾	47½	6¾	122	7,810	8,200	8,540	11,920	12,620	12,985	8,585	9,120	9,760	10,370
-------	----	-----	-----	-----	-----	----	-----	-------	-------	-------	--------	--------	--------	-------	-------	-------	--------

ACCESSORIES

TABLET ARM



12461			20	12	½			1,665									
-------	--	--	----	----	---	--	--	-------	--	--	--	--	--	--	--	--	--

CUP HOLDER



10774			4 dia					680									
-------	--	--	-------	--	--	--	--	-----	--	--	--	--	--	--	--	--	--

POWER

Simple Dot Forums



White receptacle, model #11867/W \$315 list



White stacked USB, model #11868/W \$545 list



Black receptacle, model #11967/B \$315 list



Black stacked USB, model # 11868/B \$545 list

Model # 10777
Radius on legs



Tablet arm available in white or silver finish



Standard Features:

- Seat depth: 22" d
- Seat and back cushions have a foam core with Dacron wrap.
- Legs standard in mirror polish.
- Radius Low Back chair is available with wood back on exterior. Select from standard Nienkämper veneer & stains.
- Radius High Back chair is only available fully upholstered.

Optional Features:

- Tablet top available in pure White or Black ½" thick Fingerprint Resistance solid material.
- Tablet arm support in silver or white powder coat finish
- Cup holder available in polished or brushed aluminum.
- Cup holder top with leather or vinyl inset in white or black as standard.
- Power Outlet or stacked USB Charger with 72" cord in white or black finish.

LOUNGE SEATING

Rowan Lounge Collection Designer - Yabu Pushelburg

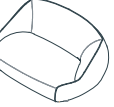
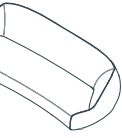
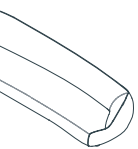
Model Number	Seat		D"	H"	Fabric		COM	COL	Neather	Verde	Grano	Cremoso	- US Only - Knoll Textiles					
	H"	W"			Yds.	Sq. Ft.							1	2	3	4		
ROWAN LOUNGE CHAIR																		
	10660 on glides	16	34 $\frac{7}{8}$	36	27 $\frac{3}{4}$	5.5	99	4,545	4,775	5,090	7,540	8,340	11,275	5,175	5,615	6,135	6,635	
	10661 swivel base	16	34 $\frac{7}{8}$	36	27 $\frac{3}{4}$	5.5	99	4,715	4,955	5,275	7,730	8,530	11,460	5,345	5,790	6,310	6,805	
ROWAN LARGE LOUNGE CHAIR																		
	10662	16	52 $\frac{7}{8}$	36	27 $\frac{3}{4}$	6.5	117	5,215	5,480	5,870	8,755	9,320	9,895	5,960	6,480	7,095	7,685	
ROWAN 2-SEATER SOFA																		
	10663	16	82 $\frac{7}{8}$	36	27 $\frac{3}{4}$	7	126	6,155	6,465	6,860	9,995	10,605	11,215	6,960	7,515	8,175	8,810	
ROWAN 3-SEATER SOFA																		
	10664	16	118 $\frac{7}{8}$	36	27 $\frac{3}{4}$	8	144	7,700	8,085	8,500	12,115	12,820	13,515	8,620	9,255	10,010	10,735	

Standard Features:

- Constructed from soy based polyurethane foam over rigid frame
- Sofa sits on glides
- Lounge Chair is available on glides or swivel base

Model # 10661
Rowan Arm Lounge Chair upholstered in Knoll Velvetk 784/74 Moss



Model # 10664
Rowan Lounge 3 Seater Sofa upholstered in Maharam 466420 Huddle Pottery 002



LOUNGE SEATING

Satori™ & Satori™ with Tablet Arm Designer - Mark Saffell & David Ritch

Model Number	Seat H"	Arm H"	W"	D"	H"	Fabric Yds.	Leather Sq. Ft.	COM	COL	Neather	Verde	Grano	Cremoso	- US Only - Knoll Textiles			
														1	2	3	4

SATORI



23201	17 ½	28 ½	26 ½	25	30	3 ½	52	3,390	3,555	3,825	5,540	6,115	6,340	3,795	4,070	4,400	4,715
--------------	------	------	------	----	----	-----	----	-------	-------	-------	-------	-------	-------	-------	-------	-------	-------

SATORI WITH LOW ARM



23203	17 ½	24 ¾	26 ½	25	30	3 ½	50	3,285	3,460	3,725	5,455	6,025	6,240	3,690	3,965	4,295	4,610
--------------	------	------	------	----	----	-----	----	-------	-------	-------	-------	-------	-------	-------	-------	-------	-------

SATORI WITH TABLET ARM



23202	17 ¼	24 ¾	30 ¾	24 ¼	30 ½	3 ½	50	5,085	5,345	5,530	7,240	7,830	8,060	5,490	5,765	6,100	6,415
--------------	------	------	------	------	------	-----	----	-------	-------	-------	-------	-------	-------	-------	-------	-------	-------

Satori and Satori with Tablet Arm are available as CAL 133 certified for an upcharge of \$550 list per chair. Certification applies to Nienkämper leathers and fabrics that have a minimum of 50% natural fibre content. COM's and COL's are subject to approval. Add the extension -CAL to the model number when ordering.

Model # 23201
Satori



Model # 23202
A mesh pocket for storage and interchangeable cup holder.

Model # 23202
Satori with interchangeable tablet arm accommodates right and left-handed users.



Castors on the Satori chair make it easy to reconfigure meeting space.

Satori with Tablet Arm

Mesh pocket dimensions are 21" w x 11" h. The tablet arm is made of marine-grade plastic. Legs are cast aluminum.







Specify polished or brushed aluminum finish for tablet holder, cup holder & leg finish.

Handle is in brushed stainless steel finish

LOUNGE SEATING

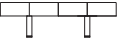
Six Collection Designer – Nienkämper

– US Only –
Knoll Textiles

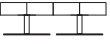
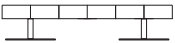



Model Number	Seat H"	Arm H"	W"	D"	H"	Fabric Yds.	Leather Sq. Ft.	COM	COL	Neather	Verde	Grano	Cremoso	1	2	3	4		
LOUNGE CHAIR																			
	30301	16	23¾	32	28	30½	3	45	3,505	3,665	3,725	4,745	5,070	5,200	3,850	4,085	4,370	4,645	
LOUNGE CHAIR W TABLET																			
	30302	16	23¾	32	28	30½	3	45	4,135	4,345	4,345	5,375	5,700	5,815	4,480	4,715	5,000	5,275	
2 SEAT BENCH																			
	30303	17		55	31½		3	45	4,690	4,870	4,985	6,535	7,010	7,210	5,035	5,275	5,555	5,830	
3 SEAT BENCH																			
	30304	17		82	31½		4½	81	5,250	5,470	5,700	8,015	8,740	9,025	5,770	6,130	6,555	6,960	
OTTOMAN																			
	30305	17		28	27¾		1½	27	3,130	3,255	3,290	4,065	4,300	4,390	3,305	3,425	3,565	3,705	
	30310	17		28	27¾		1½	27	2,350	2,470	2,495	3,270	3,505	3,605	2,520	2,645	2,785	2,920	
2 SEAT BENCH ON PEDESTALS																			
	30308	17		63	31½		3	54	3,895	4,075	4,200	5,735	6,225	6,420	4,240	4,475	4,760	5,030	
3 SEAT BENCH ON PEDESTALS																			
	30309	17		82	31½		4½	81	4,460	4,680	4,910	7,215	7,935	8,225	4,980	5,335	5,760	6,165	
SIX COLLECTION ACCESSORIES																			
Cup	30306																	100	
Cup holder	30307																		105

Six Collection passes CAL 133 certified for an upcharge of \$550 list per chair, \$640 per 2 seat bench, \$830 per 3 seat bench and \$485 per ottoman. Certification applies to Nienkämper leathers and fabrics that have a minimum of 50% natural fibre content. COM's and COL's are subject to approval. Add the extension -CAL to the model number when ordering.

LOUNGE SEATING

Turnaround® Designer - Nienkämper

– US Only –

Model Number	Seat H"	Arm H"	W"	D"	H"	Fabric Yds.	Leather Sq. Ft.	COM	COL	Verde	Grano	Cremoso	Knoll Textiles										
													1	2	3	4							
LOUNGE CHAIR WITHOUT ARMS																							
	15401	18¾	25	32	32¼	2½	41								2,670	2,820	4,005	4,460	4,590	2,960	3,160	3,395	3,620
LOUNGE CHAIR WITH ARMS																							
	15402	18¾	25¼	36	32	32¼	3½	50							3,950	4,155	5,575	6,110	6,295	4,355	4,635	4,965	5,280
LOUNGE CHAIR WITH TABLET ARMS																							
	15405	18¾	25¼	36	32	32¼	3	50							5,730	6,010	7,435	7,875	8,075	6,075	6,315	6,595	6,870
OTTOMAN																							
	15403	17½	21½	21½		1¾	30								1,300	1,360	2,335	2,585	2,700	1,495	1,625	1,780	1,930
OPTIONAL OTTOMAN TOP ACCESSORY																							
	15404		22½	22½	1¾		8			875	915												





Turnaround

- Hardwood/Plywood frame, polyurethane foam and Fortrel.
- The back rest on the Armless chair can swivel 360 degrees around the seat with also turns.
- The back swivels independent of the seat and base.
- The Armchair turns (swivels) on its base.
- The round ottoman turns (swivels) and has an optional leather tray that acts as a cocktail table.
- Tablet Arm is made of marine-grade plastic.

LOUNGE SEATING

Tuxedo™ Designer – Nienkämper

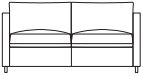
– US Only –

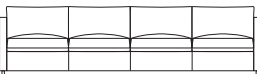
Model Number	Seat H"	Arm H"	W"	D"	H"	Fabric Yds.	Leather Sq. Ft.	COM	COL	Verde	Grano	Cremoso	Knoll Textiles							
													1	2	3	4				
ARMLESS LOUNGE																				
	765	18		25 3/4	35 3/4	29	4	65												
LOUNGE																				
	765-1	18	24 3/4	31 3/4	35 3/4	29	7 1/2	92												
TWO SEAT SOFA																				
	765-2	18	24 3/4	57 1/2	35 3/4	29	11 1/2	132												
THREE SEAT SOFA																				
	765-3	18	24 3/4	83 1/4	35 3/4	29	16	172												
FOUR SEAT SOFA																				
	765-4	18	24 3/4	109	35 3/4	29	20 1/2	212												

Tuxedo passes CAL 133 certified for an upcharge of \$550 list per chair for armless and arm chair, \$975 list per 2 seat sofa, \$1460 list per 3 seat sofa and \$1945 list per 4 seat sofa. Certification applies to Nienkämper leathers and fabrics that have a minimum of 50% natural fibre content. COM's and COL's are subject to approval. Add the extension -CAL to the model number when ordering.

This Tuxedo sofa is offered without a welting detail. The armless lounge chair has finished sides.



When upholstered in leather or COM, seat and back cushions are a foam core with a Dacron wrap. Seat and back cushions are loose.

The base is a recessed ebonized runner.

LOUNGE SEATING

Tuxedo™ Designer – Nienkämper

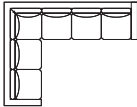
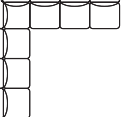
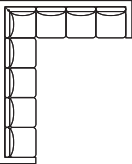
– US Only –

Model Number	Seat H"	Arm H"	W"	D"	H"	Fabric Yds.	Leather Sq. Ft.	COM	COL	Verde	Grano	Cremoso	Knoll Textiles										
													1	2	3	4							
SIX SEAT L-SHAPED SOFA																							
 765-6	18	24¾	116	90¼	29	32	322								23,620	24,805	42,170	47,030	48,970	27,285	29,840	32,860	35,755
SEVEN SEAT L-SHAPED SOFA																							
 765-7	18	24¾	116	116	29	36	362								26,430	27,770	47,530	53,070	55,285	30,550	33,425	36,825	40,080
EIGHT SEAT L-SHAPED SOFA																							
 765-8	18	24¾	116	141¾	29	40	402								30,135	31,640	53,770	60,000	62,485	34,715	37,905	41,685	45,300
OTTOMAN																							
 765-5			25¾	25¾	17¾	2½	42								2,440	2,575	4,710	5,310	5,560	2,725	2,925	3,165	3,390

This Tuxedo sofa is offered without a welting detail.





When upholstered in leather or COM, seat and back cushions are a foam core with a Dacron wrap. Seat and back cushions are loose.

The base is a recessed ebonized runner.

LOUNGE SEATING

Tuxedo Classic™ Low Arm Designer – Nienkämper

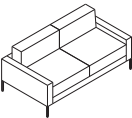
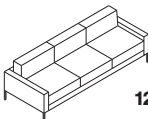
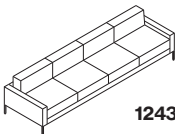
– US Only –

Model Number	Seat Arm		W"	D"	H"	Fabric Leather		COM	COL	Neather	Verde	Grano	Cremoso	Knoll Textiles				
	H"	H"				Yds.	Sq. Ft.							1	2	3	4	
LOUNGE CHAIR ON LEGS																		
	12431	17	21¾	30½	30½	29¾	4½	72	4,215	4,795	4,425	7,180	7,955	8,290	4,735	5,090	5,515	5,920
LOUNGE CHAIR - SWIVEL BASE																		
	12443	17	21¾	30½	30½	29¾	5½	72	4,040	4,225	4,560	6,870	7,630	7,905	4,670	5,110	5,630	6,130
TWO SEAT SOFA																		
	12432	17	21¾	55	30½	29¾	6	96	6,135	6,430	6,870	10,095	11,130	11,545	6,820	7,300	7,865	8,415
THREE SEAT SOFA																		
	12433	17	21¾	79½	30½	29¾	7½	120	8,065	8,445	8,970	13,000	14,305	14,820	8,925	9,525	10,235	10,910
FOUR SEAT SOFA																		
	12434	17	21¾	104	30½	29¾	9	150	9,800	10,290	10,905	16,000	17,615	18,280	10,835	11,545	12,400	13,210
OTTOMAN																		
	12425	17		25	25	17	2¾	24	1,940	2,045	2,270	2,950	3,200	3,320	2,255	2,475	2,740	2,985

Tuxedo Classic with legs passes CAL 133 certified for an upcharge of \$550 list per chair, \$975 list per two seat sofa, \$1460 list per three seat sofa, \$1945 list per four seat sofa, and \$485 list per ottoman. Certification applies to Nienkämper leathers and fabrics that have a minimum of 50% natural fibre content. COM's and COL's are subject to approval. Add the extension -CAL to the model number when ordering.

Model #12431
Lounge chair fully upholstered in



Tuxedo Classic is offered without a welting detail. Seat and back cushions have a foam core with Dacron wrap. Back cushions are attached to the frame. Seat cushions are loose.





Square tubular legs made of aluminum are available in a brushed finish. A polished finish is available for an upcharge of \$170 per chair or sofa.

The swivel disk base is upholstered to match the frame.

LOUNGE SEATING

Tuxedo Classic™ Low Arm with Tufting Designer – Nienkämper

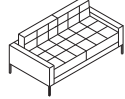
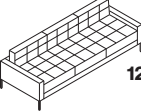
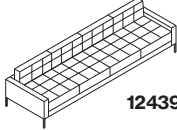
– US Only –

Model Number	Seat H"	Arm H"	W"	D"	H"	Fabric Yds.	Leather Sq. Ft.	COM	COL	Neather	Verde	Grano	Cremoso	Knoll Textiles				
														1	2	3	4	
LOUNGE CHAIR ON LEGS																		
	12436	17	21¾	30½	30½	29¾	4½	72	4,465	4,685	5,010	7,435	8,210	8,530	4,985	5,340	5,765	6,170
LOUNGE CHAIR - SWIVEL BASE																		
	12444	17	21¾	30½	30½	29¾	5½	72	4,275	4,475	4,795	7,125	7,860	8,140	4,905	5,345	5,865	6,365
TWO SEAT SOFA																		
	12437	17	21¾	55	30½	29¾	6	96	6,570	6,905	7,325	10,535	11,575	12,000	7,260	7,735	8,305	8,850
THREE SEAT SOFA																		
	12438	17	21¾	79½	30½	29¾	7½	120	8,680	9,115	9,625	13,640	14,940	15,470	9,540	10,140	10,850	11,525
FOUR SEAT SOFA																		
	12439	17	21¾	104	30½	29¾	9	150	10,635	11,165	11,745	16,830	18,450	19,105	11,670	12,380	13,230	14,045
OTTOMAN																		
	12430	17		25	25	17	2¾	24	2,125	2,230	2,440	3,100	3,360	3,475	2,440	2,660	2,920	3,170

Tuxedo Classic with legs passes CAL 133 certified for an upcharge of \$550 list per chair, \$975 list per two seat sofa, \$1460 list per three seat sofa, \$1945 list per four seat sofa, and \$485 list per ottoman. Certification applies to Nienkämper leathers and fabrics that have a minimum of 50% natural fibre content. COM's and COL's are subject to approval. Add the extension -CAL to the model number when ordering.

Tuxedo Classic with tufting is offered with a welting detail on seat and back cushions. Seat and back cushions have a foam core with Dacron wrap. Back cushions are attached to the frame. Seat cushions are loose.





Square tubular legs made of aluminum are available in a brushed finish. A polished finish is available for an upcharge of \$170 per chair or sofa.

The swivel disk base is upholstered to match the frame.

LOUNGE SEATING

Tuxedo Classic™ High Arm Designer – Nienkämper

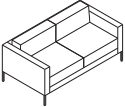
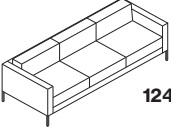
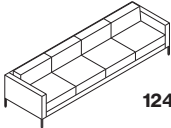
– US Only –

Model Number	Seat Arm		W"	D"	H"	Fabric Leather		COM	COL	Neather	Verde	Grano	Cremoso	Knoll Textiles				
	H"	H"				Yds.	Sq. Ft.							1	2	3	4	
LOUNGE CHAIR ON LEGS																		
	12421	17	28	30½	30½	29¾	4½	72	4,315	4,535	4,870	7,280	8,080	8,375	4,830	5,190	5,615	6,020
LOUNGE CHAIR - SWIVEL BASE																		
	12441	17	28	30½	30½	29¾	4½	72	4,125	4,340	4,670	6,985	7,715	8,045	4,755	5,195	5,715	6,215
TWO SEAT SOFA																		
	12422	17	28	55	30½	29¾	6	96	6,240	6,550	6,980	10,280	11,230	11,570	6,925	7,405	7,970	8,520
THREE SEAT SOFA																		
	12423	17	28	79½	30½	29¾	7½	120	8,160	8,570	9,090	13,105	14,425	14,935	9,020	9,620	10,330	11,005
FOUR SEAT SOFA																		
	12424	17	28	104	30½	29¾	9	150	9,910	10,405	11,020	16,095	17,730	18,385	10,945	11,655	12,510	13,320
OTTOMAN																		
	12425	17		25	25	17	2¾	24	1,940	2,045	2,270	2,950	3,200	3,320	2,255	2,475	2,740	2,985

Tuxedo Classic passes CAL 133 certified for an upcharge of \$550 list per chair, \$975 list per two seat sofa, \$1460 list per three seat sofa, \$1945 list per four seat sofa, and \$485 list per ottoman. Certification applies to Nienkämper leathers and fabrics that have a minimum of 50% natural fibre content. COM's and COL's are subject to approval. Add the extension -CAL to the model number when ordering.

Model #12421
Lounge chair fully upholstered in leather



Tuxedo Classic is offered without a welting detail. Seat and back cushions have a foam core with Dacron wrap. Back cushions are attached to the frame. Seat cushions are loose.





Square tubular legs made of aluminum are available in a brushed finish. A polished finish is available for an upcharge of \$170 per chair or sofa.

The swivel disk base is upholstered to match the frame.

LOUNGE SEATING

Tuxedo Classic™ High Arm with Tufting Designer – Nienkämper

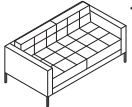
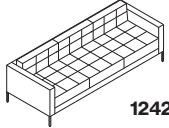
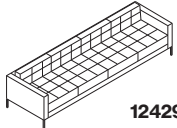
– US Only –

Model Number	Seat H"	Arm H"	W"	D"	H"	Fabric Yds.	Leather Sq. Ft.	COM	COL	Neather	Verde	Grano	Cremoso	Knoll Textiles			
														1	2	3	4
LOUNGE CHAIR ON LEGS																	
 12426	17	28	30½	30½	29¾	4½	72	4,570	4,795	5,125	7,570	8,330	8,630	5,090	5,445	5,870	6,275
LOUNGE CHAIR - SWIVEL BASE																	
 12442	17	28	30½	30½	29¾	5½	72	4,455	4,585	4,905	7,215	7,955	8,270	5,085	5,525	6,045	6,545
TWO SEAT SOFA																	
 12427	17	28	55	30½	29¾	6	96	6,690	7,020	7,415	10,640	11,690	12,110	7,380	7,855	8,425	8,970
THREE SEAT SOFA																	
 12428	17	28	79½	30½	29¾	7½	120	8,800	9,225	9,720	13,750	15,045	15,590	9,660	10,260	10,970	11,645
FOUR SEAT SOFA																	
 12429	17	28	104	30½	29¾	9	150	10,745	11,270	11,855	16,935	18,560	19,210	11,780	12,490	13,345	14,155
OTTOMAN																	
 12430	17		25	25	17	2¾	24	2,125	2,230	2,440	3,100	3,360	3,475	3,160	3,870	4,720	5,535

Tuxedo Classic passes CAL 133 certified for an upcharge of \$550 list per chair, \$975 list per two seat sofa, \$1460 list per three seat sofa, \$1945 list per four seat sofa, and \$485 list per ottoman. Certification applies to Nienkämper leathers and fabrics that have a minimum of 50% natural fibre content. COM's and COL's are subject to approval. Add the extension -CAL to the model number when ordering.

Tuxedo Classic with tufting is offered with a welting detail on seat and back cushions. Seat and back cushions have a foam core with Dacron wrap. Back cushions are attached to the frame. Seat cushions are loose.

Square tubular legs made of aluminum are available in a brushed finish. A polished finish is available for an upcharge of \$170 per chair or sofa.

The swivel disk base is upholstered to match the frame.

Model #12426
Lounge chair



Model #12427
Two seat sofa



Model #12427
Two seat sofa



Model #12428
Three seat sofa



LOUNGE SEATING

Tuxedo™ Cove Designer – Nienkämper

– US Only –

Model Number	Seat H"	Arm H"	W"	D"	H"	Fabric Yds.	Leather Sq. Ft.	COM	COL	Verde	Grano	Cremoso	Knoll Textiles			
													1	2	3	4

TUXEDO™ COVE THREE SEAT SOFA LEFT

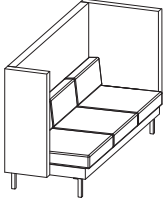

12449	17	46	79¼	31	46	12	216										
COM Frame						8¼	149										
COM Seat & Back Cushion						4½	81										

11,085	11,635	16,640	18,570	19,235	12,460	13,415	14,550	15,635
--------	--------	--------	--------	--------	--------	--------	--------	--------

TUXEDO™ COVE THREE SEAT SOFA RIGHT

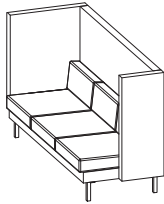

12450	17	46	79¼	31	46	12	216										
COM Frame						8¼	149										
COM Seat & Back Cushion						4½	81										

11,085	11,635	16,640	18,570	19,235	12,460	13,415	14,550	15,635
--------	--------	--------	--------	--------	--------	--------	--------	--------

INTERCONNECTING PANEL

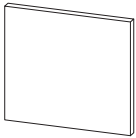

12451			44	3	38¾	2¾	50										
--------------	--	--	----	---	-----	----	----	--	--	--	--	--	--	--	--	--	--

2,590	2,720	4,245	4,545	4,685	2,905	3,125	3,390	3,635
-------	-------	-------	-------	-------	-------	-------	-------	-------

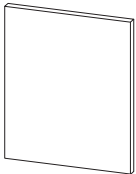

12452			44	3	46	3½	63										
--------------	--	--	----	---	----	----	----	--	--	--	--	--	--	--	--	--	--

3,130	3,290	5,215	5,580	5,765	3,535	3,815	4,145	4,460
-------	-------	-------	-------	-------	-------	-------	-------	-------

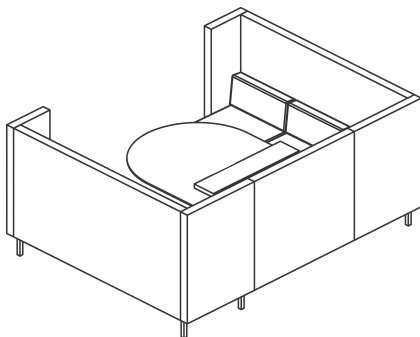

Tuxedo™ Cove Sofa with interconnecting panel
Model # 12451

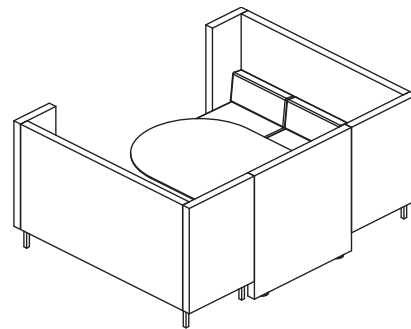

Tuxedo™ Cove Sofa with interconnecting panel
Model # 12452
panel with integrated cavity for wire management

LOUNGE SEATING

Tuxedo™ Cove & Gateway™ Media Lift/Wall Mounted Table Designer – Nienkämper & Busk + Hertzog

Tuxedo™ Cove is composed of two 3 seat high back sofas with an interconnecting panel and table to form an enclosed booth for meetings, collaborative tasks or to be used as a touchdown base for the day. The high sides and back provide total seclusion from the surrounding environment without the need for interior substructures while additional privacy is maintained via the acoustic benefits of the interconnecting panel and the sofas high walls.

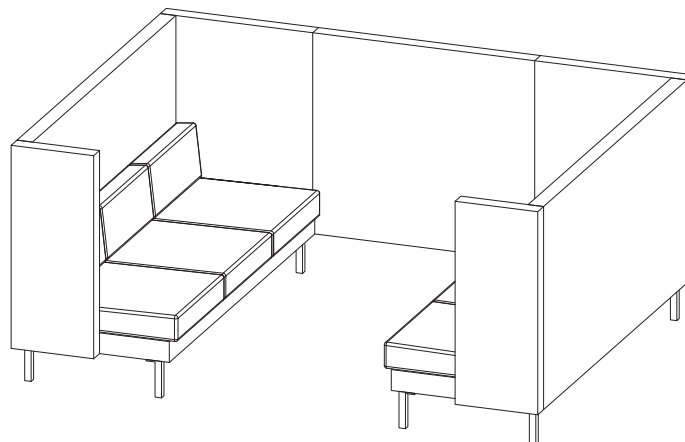

LOUNGE SEATING

Tuxedo™ Cove & Gateway™ Media Lift Table Designer – Nienkämper & Busk + Hertzog

Table options for Tuxedo™ Cove include the Gateway™ tables, with a full range of connectivity. The Gateway™ Media Lift Table with Relaxed Work Height (26" H) provides a free standing solution while the Gateway™ Wall Mounted Table with Relaxed Work Height (26" H) offers another option for television screen and monitor to be mounted on the interconnecting panel.

Gateway™ Media Lift Table effortlessly transforms meeting tables to create innovative multimedia solutions for communication, presentations and interactive work spaces. At the touch of the remote control, the unit raises the monitor screen up from the base cabinet. The ultimate in professional appearance, Gateway™ Media Lift combines sophistication and function to create additional space, protect your TV from damage or to hide it away from sight.

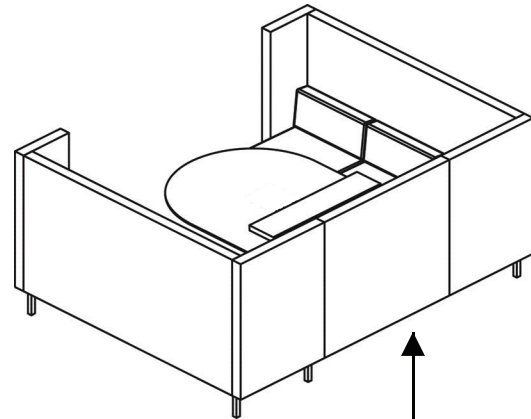

interconnecting panel: 39" h
Model # 12451

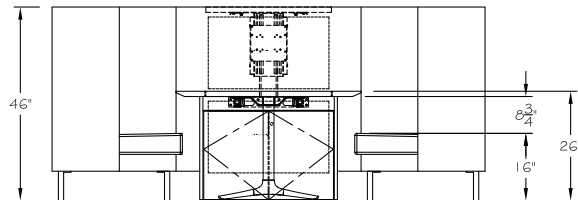
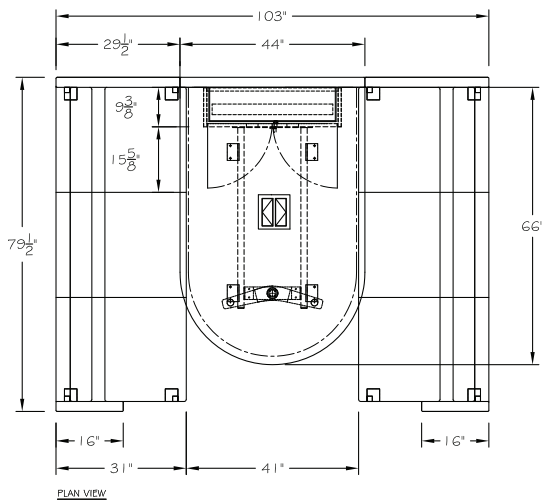

Model #	Description	Quantity	List Price
12449	Tuxedo™ Cove Three Seat Sofa Left in COM	1	11,085
12450	Tuxedo™ Cove Three Seat Sofa Right in COM	1	11,085
12451	Interconnecting Panel (39" H) in COM	1	2,590
43031/5	Gateway Media Lift Table – Relaxed Work Height 26" H in Standard P-lam	1	14,205
85209	Simple Double Sided PopUp Forum Each side with two power & two open ports	1	1,375
Total List:			40,340

Note:

- Gateway™ Media Lift Table Dimension 66" L x 44" D x 26" H.
- For standard veneer finish, model #43031/2, list price is \$15,485.
- TV lift can accommodate a maximum TV size of 32".
- TV lift is included. TV is not included.

LOUNGE SEATING

Tuxedo™ Cove & Gateway™ Wall Mounted Table Designer – Nienkämper & Busk + Hertzog

Gateway™ Wall Mounted Table provides a simple solution by mounting a TV or monitor screen directly onto the interconnecting panel. The wall mounted Gateway™ table with single base provides maximum knee space for users.

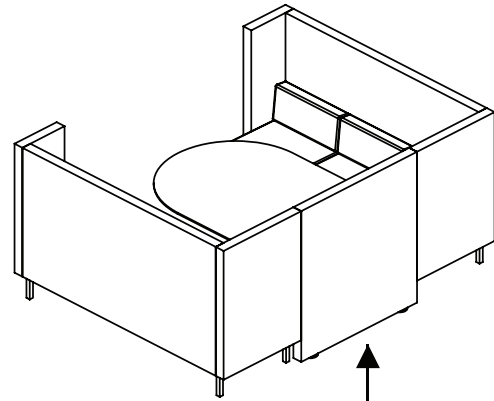
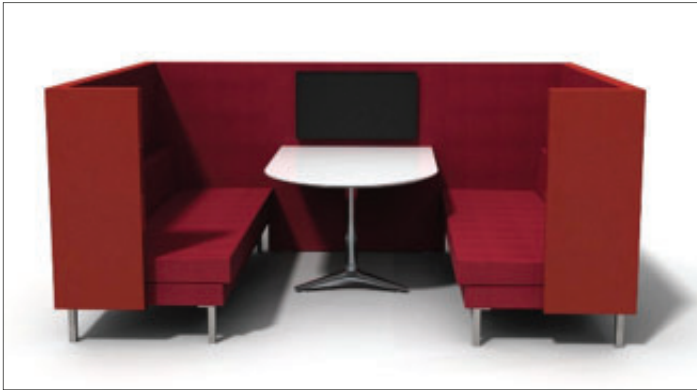

interconnecting panel: 46" h
Model # 12452

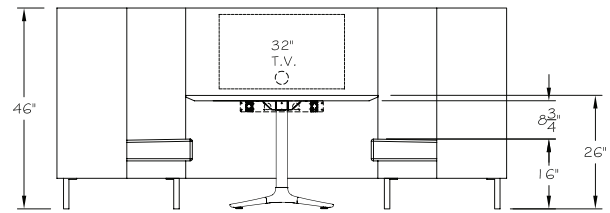
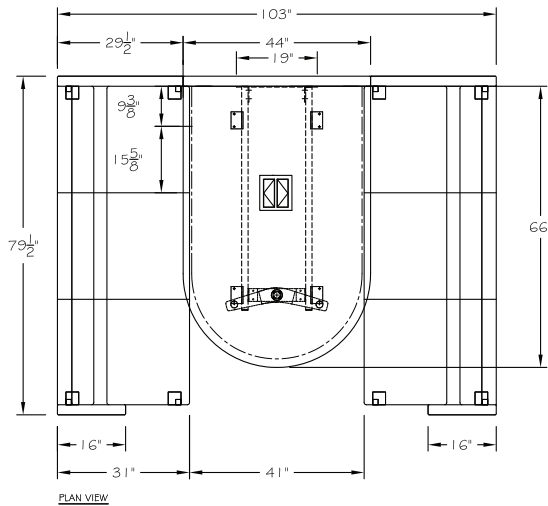

Model #	Description	Quantity	List Price
12449	Tuxedo™ Cove Three Seat Sofa Left in COM	1	11,085
12450	Tuxedo™ Cove Three Seat Sofa Right in COM	1	11,085
12452	Interconnecting Panel (46" H) in COM	1	3,130
43041/5	Gateway Wall Mounted Table – Relaxed Work Height 26" H in Standard P-lam	1	7,325
85209	Simple Double Sided PopUp Forum Each side with two power & two open ports	1	1,375
Total List:			34,000

Note:

- Gateway Wall Mounted Table Dimension 66" L x 44" D x 26" H.
- For standard veneer finish, model # 43041/2, list price is \$8,595.
- Maximum TV size to be mounted on panel is 32".
- TV & TV mount are not included.

LOUNGE SEATING

Tuxedo™ High Back Designer – Nienkämper

– US Only –

Model Number	Seat Arm			D"	H"	Fabric Yds.	Leather Sq. Ft.	COM	COL	Verde	Grano	Cremoso	Knoll Textiles			
	H"	H"	W"										1	2	3	4

TWO SEAT SOFA



12445	17	46	55	31	46	9¼	167	8,730	9,165	13,590	15,195	15,730	9,790	10,530	11,400	12,235
COM Frame						6¾	112									
COM Seat & Back Cushion						3	54									

LARGE TWO SEAT SOFA



12447	17	46	64	31	46	11¼	203	10,145	10,640	15,805	17,680	18,315	11,435	12,335	13,395	14,415
COM Frame						7½	135									
COM Seat & Back Cushion						3¾	68									

THREE SEAT SOFA

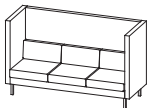

12446	17	46	79½	31	46	12½	225	11,665	12,250	17,595	19,580	20,235	13,095	14,095	15,275	16,405
COM Frame						8¾	157									
COM Seat & Back Cushion						4½	81									

Tuxedo™ High Back passes CAL 133 certified for an upcharge of \$975 list per two seat sofa and \$1460 list per three seat sofa. Certification applies to Nienkämper leathers and fabrics that have a minimum of 50% natural fibre content. COM's and COL's are subject to approval. Add the extension -CAL to the model number when ordering.

Model # 12446
Tuxedo High Back 3 Seat Sofa



LOUNGE SEATING

Tuxedo™ High Back Designer – Nienkämper

– US Only –

Model Number	Seat Arm			D"	H"	Fabric Yds.	Leather Sq. Ft.	COM	COL	Verde	Grano	Cremoso	Knoll Textiles			
	H"	H"	W"										1	2	3	4

HIGH BACK LOUNGE CHAIR



12448	17	46	37¼	31	46	8	144									
COM Frame						6½	117									
COM Seat & Back Cushion						2	36									

6,550	7,640	10,940	11,565	11,875	7,470	8,105	8,860	9,585
-------	-------	--------	--------	--------	-------	-------	-------	-------

ACCESSORIES

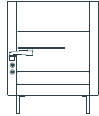

Lounge chair with tablet & power

ARM SIDE CUSHION

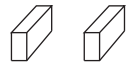

12460		19	3	7	¾	14										
--------------	--	----	---	---	---	----	--	--	--	--	--	--	--	--	--	--

945	995	1,420	1,505	1,545	1,035	1,095	1,170	1,235
-----	-----	-------	-------	-------	-------	-------	-------	-------

Note: Dimension is for one piece. List price & yardage is for a set of two pieces

TABLET



12461		20	12	½												
--------------	--	----	----	---	--	--	--	--	--	--	--	--	--	--	--	--

1,665

Features:

Cushion: Seat and back cushions have a foam core with Dacron wrap. Back cushions are attached to the frame. Seat cushions are loose.

Legs: Square tubular legs made of cast aluminum are available in a brushed finish. A polished finish is available for an upcharge of \$170 list per chair or sofa.

Tablet: Fingerprint resistance solid ½" thick material top, color available in pure white or black, with silver or white powder coat arm support.

Power: Standard in white or black finish with 72" cords.

Vox Simple Dot Forums



White receptacle, model #11867/W \$315 list



White stacked USB, model #11868/W \$545 list



Black receptacle, model #11967/B \$315 list



Black stacked USB, model # 11868/B \$545 list



2 Port, power & USB charger white, model #11866W \$1,030 list



2 Port, power & USB charger black, model #11866/B \$1,030 list

Model # 12448
Tuxedo High Back Lounge Chair upholstered in Verde leather / Graphite VE 6008 with arm side cushion, tablet & power

Model # 12448



LOUNGE SEATING

Wavelength® Designer - Karim Rashid

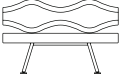
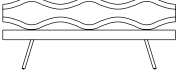
	Model Number	Seat H"	W"	D"	H"	Fabric		COM	COL	Verde	Grano	Cremoso	- US Only - Knoll Textiles				
						Yds.	Sq. Ft.						1	2	3	4	
CHAIR																	
	1401_	16¾	23⅝	31	30¾												
	(Model #1)	Fully upholstered				1½	24	4,000	4,200	4,985	5,260	5,370	4,170	4,290	4,435	4,570	
	(Model #2)	Fabric seat & back, fabric contrasting trim				¾	¾	4,000					4,170	4,290	4,435	4,570	
	(Model #3)	Leather seat & back, leather contrasting trim				12	12		4,200	4,985	5,260	5,370					
TWO SEAT SOFA																	
	1402_	16¾	47¼	31	30¾												
	(Model #1)	Fully upholstered				3	48	4,720	4,965	6,715	7,225	7,440	5,070	5,305	5,590	5,860	
	(Model #2)	Fabric seat & back, fabric contrasting trim				1½	1½	4,720					5,070	5,305	5,590	5,860	
	(Model #3)	Leather seat & back, leather contrasting trim				24	24		4,965	6,715	7,225	7,440					
THREE SEAT SOFA																	
	1403_	16¾	70⅞	31	33												
	(Model #1)	Fully upholstered				4½	72	5,480	5,745	8,445	9,225	9,545	6,000	6,355	6,780	7,185	
	(Model #2)	Fabric seat & back, fabric contrasting trim				2¼	2¼	5,480					6,000	6,355	6,780	7,185	
	(Model #3)	Leather seat & back, leather contrasting trim				36	36		5,745	8,445	9,225	9,545					

Wavelength passes CAL 133 certified for an upcharge of \$550 list per chair, \$975 list per 2 seat sofa and \$1,460 list per 3 seat sofa. Certification applies to Nienkämper leathers and fabrics that have a minimum of 50% natural fibre content. COM's and COL's are subject to approval. Add the extension -CAL to the model number when ordering.

Fabric direction when railroaded

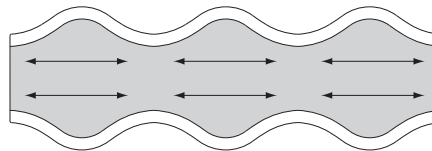

Fabric yardages are based on plain fabrics with no apparent pattern direction. Fabric is railroaded.

When upholstering in two different fabrics or leathers use the COM price or COL price and ship yardages or square footage as noted on page 7. Most fabrics and vinyl are suitable for the top seat portion but the contrasting trim must have stretch.

Nienkämper reserves the right to determine the suitability of COM on our furniture. For further details regarding approvals, refer to page 7.

Specify polished or brushed aluminum frame

Fabric to be upholstered on Wavelength requires approval from Nienkämper's factory. Please contact customer service at 800 668 9318 for our fabric approval list.

Model #14012
Contrasting trim,
polished aluminum
frame



Model #14032
Contrasting trim,
polished aluminum
frame



Model #14031
Fully upholstered,
polished aluminum frame

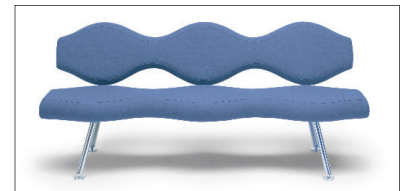

LOUNGE SEATING

Wavelength® Designer - Karim Rashid

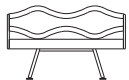
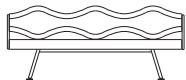
Model Number	Seat H"	W"	D"	H"	Fabric Yds.	Leather Sq. Ft.	COM	COL	Verde	Grano	Cremoso	- US Only - Knoll Textiles						
												1	2	3	4			
CHAIR WITH ARM																		
	1401_	16 3/4	23 5/8	31	30 3/4													
	(Model #7)	Fully Upholstered			1 1/2	24	5,995	6,300	6,985	7,240	7,370	6,165	6,285	6,430	6,565			
	(Model #8)	Fabric seat & back, fabric contrasting trim			3/4	3/4	6,010					6,165	6,285	6,430	6,565			
	(Model #9)	Leather seat & back, leather contrasting trim			12	12		6,300	6,985	7,240	7,370							
TWO SEAT SOFA WITH ARM																		
	1402_	16 3/4	47 1/4	31	30 3/4													
	(Model #7)	Fully Upholstered			3	48	6,740	7,055	8,705	9,215	9,440	7,085	7,320	7,605	7,875			
	(Model #8)	Fabric seat & back, fabric contrasting trim			1 1/2	1 1/2	6,740					7,085	7,320	7,605	7,875			
	(Model #9)	Leather seat & back, leather contrasting trim			24	24		7,055	8,705	9,215	9,440							
THREE SEAT SOFA WITH ARM																		
	1403_	16 3/4	70 7/8	31	33													
	(Model #7)	Fully Upholstered			4 1/2	72	7,480	7,860	10,450	11,225	11,545	8,000	8,355	8,780	9,185			
	(Model #8)	Fabric seat & back, fabric contrasting trim			2 1/4	2 1/4	7,480					8,000	8,355	8,780	9,185			
	(Model #9)	Leather seat & back, leather contrasting trim			36	36		7,860	10,450	11,225	11,545							

Wavelength passes CAL 133 certified for an upcharge of \$550 list per chair, \$975 list per 2 seat sofa and \$1,460 list per 3 seat sofa. Certification applies to Nienkämper leathers and fabrics that have a minimum of 50% natural fibre content. COM's and COL's are subject to approval. Add the extension -CAL to the model number when ordering.

Fabric direction when railroaded

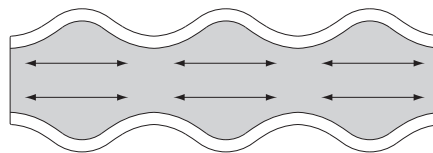

Fabric yardages are based on plain fabrics with no apparent pattern direction. Fabric is railroaded.

When upholstering in two different fabrics or leathers use the COM price or COL price and ship yardages or square footage as noted on page 7. Most fabrics and vinyl are suitable for the top seat portion but the contrasting trim must have stretch.

Nienkämper reserves the right to determine the suitability of COM on our furniture. For further details regarding approvals, refer to page 7.

Specify polished or brushed aluminum frame

Fabric to be upholstered on Wavelength requires approval from Nienkämper's factory. Please contact customer service at 800 668 9318 for our fabric approval list.

Model #14037
Polished aluminum frame and arms

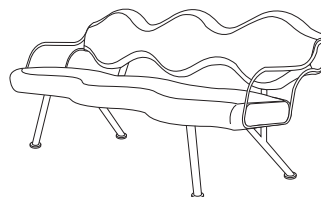

Arms with table on both sides available at an upcharge of \$720 each or \$1440 a pair

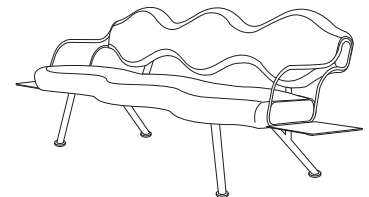

nienkämpfer

SEATING & MEETING PODS

STOOLS & BENCHES



2026

STOOLS AND BENCHES



TABLE OF CONTENTS

Stools and Benches	84-95
Blottoman™	86
Caravite	87
Jackal	88
Kloud® Benches	89
Mint	90
Moment Collection	91
Six® Collection Benches	92
Spin Stool/Tables	93
Wavelength® Benches	94
Zoo Stools	95

STOOLS AND BENCHES

Blottoman™ Benches Designer - Karim Rashid

– US Only –

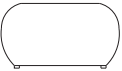
Model Number	Seat H"	W"	D"	H"	Fabric		Leather				Knoll Textiles					
					Yds.	Sq. Ft.	COM	COL	Verde	Grano	Cremoso	1	2	3	4	
BLOTTOMAN																
	14902 Fully Upholstered	14	18	18	14	1 1/3	23	870	905	1,605	1,810	1,890	1,020	1,130	1,255	1,380
	14906 Contrasting fabric					1/2		870					1,020	1,130	1,255	1,380
	14907 Contrasting leather						9	905	1,605	1,810	1,890					
BLOTTOMAN SQUARE BENCH																
	14911 Fully Upholstered	17 1/2	24	24	17 1/2	1 1/3	23	1,390	1,465	2,345	2,585	2,700	1,540	1,650	1,775	1,900
	14912 Contrasting fabric					2/3		1,390					1,540	1,650	1,775	1,900
	14913 Contrasting leather						10	1,465	2,345	2,585	2,700					
BLOTTOMAN TWO SEAT BENCH																
	14914 Fully Upholstered	17 1/2	48	24	17 1/2	2 1/3	35	2,410	2,535	3,845	4,225	4,370	2,680	2,870	3,090	3,300
	14915 Contrasting fabric					1 2/3		2,410					2,680	2,870	3,090	3,300
	14916 Contrasting leather						22	2,535	3,845	4,225	4,370					
BLOTTOMAN LARGE SQUARE BENCH																
	14917 Fully Upholstered	17 1/2	34	34	17 1/2	1 2/3	30	2,160	2,265	3,400	3,730	3,850	2,355	2,485	2,645	2,790
	14918 Contrasting fabric					1 2/3		2,160					2,355	2,485	2,645	
	14919 Contrasting leather						16	2,265	3,400	3,730	3,850					

Blottoman passes CAL 133 certified for an upcharge of \$485 list per square bench; two seat bench \$760 list; large square bench \$585 list; blottoman \$385 list. Certification applies to Nienkämper leathers and fabrics that have a minimum of 50% natural fibre content. COM's and COL's are subject to approval. Add the extension "-CAL" to the model number when ordering.

The curvaceous shape and soft molded foam of the Blottoman are conducive to fabrics with some stretch and minimum pattern.

When upholstered in two different fabrics or leathers, use the COM price and ship your fabric yardage or leather square footage to Nienkämper. See page 7 for COM and COL details.

Seams can have matching or contrasting stitching. Matching or contrasting welting detail can also be specified.

*For patterned or directional fabrics please contact Customer Service at 800.668.9318 for yardages.

Right: Model #14912
Left: Model # 14918
Shown with a Virso occasional table,
Model # 32020T1

Model #14915



STOOLS AND BENCHES

Caravite Designer - Busk + Hertzog

– US Only –
Knoll Textiles

Model Number	Seat H"	W"	D"	H"	Fabric		COM	COL	Neather	Verde	Grano	Cremoso	Knoll Textiles			
					Yds.	Sq. Ft.							1	2	3	4

CARAVITE STOOL



10221	31¼	18	14	31¼	¾	14	1,150	1,205	1,225	1,605	1,670	1,710	1,240	1,300	1,375	1,440
--------------	-----	----	----	-----	---	----	-------	-------	-------	-------	-------	-------	-------	-------	-------	-------

CARAVITE BENCH



10222	16½	47¾	35¾	16½	2½	41	1,915	2,015	2,140	3,160	3,380	3,480	2,200	2,400	2,640	2,865
--------------	-----	-----	-----	-----	----	----	-------	-------	-------	-------	-------	-------	-------	-------	-------	-------

Model # 10222 & 10221



Standard Features:

- Distinctive contoured seat cushion with polyurethane foam and plywood frame
- Top stitch detail is standard and contrasting stitching can also be specified.
- Tubular steel frame standard with black powder coat finish, other powder coat colors are available upon request.

STOOLS AND BENCHES

Jackal Stool Designer - Fig40

Model Number	W"	D"	H"	List Price
JACKAL STOOL				
10226	20¼	19½	37 ⅞	1,670



Model # 10226
Jackal Stool





Standard Features:

- Seat Material: stripy Beech 3D veneer
- Frame Material: stainless steel rod
- Seat Finish: standard stain & finish
- Frame Finish: brushed stainless, powder coat satin black

STOOLS AND BENCHES

Kloud[®] Benches Designer - Karim Rashid

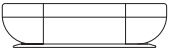
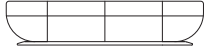
– US Only –

Model Number	Seat H"	W"	D"	Fabric		Leather				Knoll Textiles					
				Yds.	Sq. Ft.	COM	COL	Verde	Grano	Cremoso	1	2	3	4	
TWO SEAT BENCH															
	14998	16	48	30	3	56									
	Fully upholstered						3,110	3,265	4,820	5,530	5,730	3,455	3,695	3,975	4,250
	14977	Contrasting Fabric			1½		3,110					3,455	3,695	3,975	4,250
		Top/seat													
		Bottom			1½										
	14978	Contrasting Leather						3,265	4,820	5,530	5,730				
		Top/seat			27										
		Bottom				27									
TWO SEAT LARGE BENCH															
	14953	16	60	30	3½	62									
	Fully upholstered						4,045	4,240	5,930	6,730	6,930	4,450	4,725	5,060	5,375
	14951	Contrasting Fabric					4,045					4,450	4,725	5,060	5,375
		Top/seat			1¾										
		Bottom				2									
	14952	Contrasting Leather						4,240	5,930	6,730	6,930				
		Top/seat			32										
		Bottom				36									
THREE SEAT BENCH															
	14999	16	72	30	4	72									
	Fully upholstered						5,295	5,560	7,490	8,390	8,655	5,755	6,070	6,450	6,810
	14979	Contrasting Fabric					5,295					5,755	6,070	6,450	6,810
		Top/seat			2										
		Bottom				2½									
	14980	Contrasting Leather						5,560	7,490	8,390	8,655				
		Top/seat			36										
		Bottom				42									
OTTOMAN															
	14990	16	30	30	2½	45									
	Fully upholstered						2,140	2,250	3,505	4,075	4,245	2,430	2,625	2,865	3,090
	14961	Contrasting Fabric					2,140					2,430	2,625	2,865	3,090
		Top/seat			1½										
		Bottom				1¼									
	14962	Contrasting Leather						2,250	3,505	4,075	4,245				
		Top/seat			24										
		Bottom				23									

Fabric to be upholstered on Kloud requires approval from Nienkämper's factory. Please contact customer service at 800 668 9318 for our fabric approval list.

STOOLS AND BENCHES

Mint Designer - Busk + Hertzog

Model Number	Seat H"	W"	D"	H"	Fabric Yds.	Leather Sq. Ft.	COM	COL	Neather	Verde	Grano	Cremoso	- US Only - Knoll Textiles			
													1	2	3	4

MINT STOOL



10780	16½	26¼	23¾	16½	2	36								1,875	1,970	2,080	3,005	3,200	3,300	2,110	2,265	2,455	2,640
--------------	-----	-----	-----	-----	---	----	--	--	--	--	--	--	--	-------	-------	-------	-------	-------	-------	-------	-------	-------	-------

Model # 10780



Standard Features:

- Frame is constructed of plywood core
- Stool with molded foam

STOOLS AND BENCHES

Moment collection Designer - Busk + Hertzog

– US Only –

Model Number	W"	D"	H"	Fabric Yds	Leather Sq. Ft.	COM	COL	Verde	Grano	Cremoso	Knoll Textiles			
											1	2	3	4

MOMENT STOOLS

19½" top	26011	19½ dia.	16	2	36	1,555	1,635	2,635	2,855	2,965	1,785	1,945	2,135	2,320
----------	-------	----------	----	---	----	-------	-------	-------	-------	-------	-------	-------	-------	-------



16½" top	26012	16½ dia.	16	2	36	1,555	1,635	2,635	2,855	2,965	1,785	1,945	2,135	2,320
----------	-------	----------	----	---	----	-------	-------	-------	-------	-------	-------	-------	-------	-------

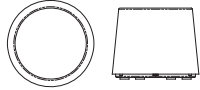

MOMENT TABLES

19½" top	26021/2	19½ dia.	16	Veneer	2,015
	26021/5			P-Lam	1,325
	26021/7			Paint	1,495

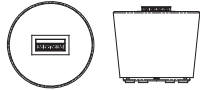

16½" top	26022/2	16½ dia.	16	Veneer	2,015
	26022/5			P-Lam	1,325
	26022/7			Paint	1,495



*List price for tables doesn't include power unit.

SIMPLE POP UP FORUM

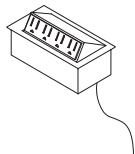

8174	1,080
(4 power pre-wired with 72" cord)	



Linking device detail

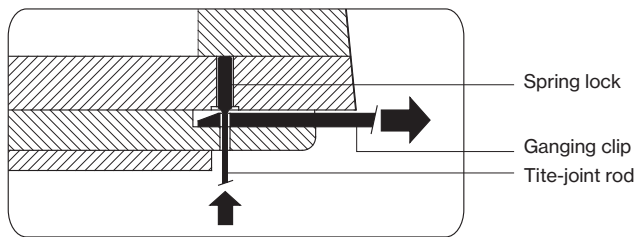





Standard Features:

- Frame is constructed of plywood core
- Stool constructed with molded foam
- Tables are offered with white, silver, black paint options or any standard wood veneer
- Non-marring glides

STOOLS AND BENCHES

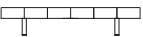
Six[®] Collection Designer - Nienkämper

– US Only –

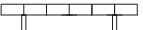



Model Number	Seat H"	W"	D"	H"	Fabric Yds.	Leather Sq. Ft.	COM	COL	Neather	Verde	Grano	Cremoso	Knoll Textiles				
													1	2	3	4	
2 SEAT BENCH																	
 30303	17	63	31½	3	54	4,690	4,870	4,985	6,535	7,010	7,210	5,035	5,275	5,555	5,830		
3 SEAT BENCH																	
 30304	17	82	31½	4½	81	5,250	5,470	5,700	8,015	8,740	9,025	5,770	6,130	6,555	6,960		
OTTOMAN																	
 30305	17	28	27¾	1½	27	3,130	3,255	3,290	4,065	4,300	4,390	3,305	3,425	3,565	3,705		
OTTOMAN ON PEDESTALS																	
 30310	17	28	27¾	1½	27	2,350	2,470	2,495	3,270	3,505	3,605	2,520	2,645	2,785	2,920		
2 SEAT BENCH ON PEDESTALS																	
 30308	17	63	31½	3	54	3,895	4,075	4,200	5,735	6,225	6,420	4,240	4,475	4,760	5,030		
3 SEAT BENCH ON PEDESTALS																	
 30309	17	82	31½	4½	81	4,460	4,680	4,910	7,215	7,935	8,225	4,980	5,335	5,760	6,165		

Six Bench passes CAL 133 certified for an upcharge of \$760 per 2 seat bench, \$930 per 3 seat bench and \$485 per ottoman. Certification applies to Nienkämper leathers and fabrics that have a minimum of 50% natural fibre content. COM's and COL's are subject to approval. Add the extension "-CAL" to the model number when ordering.

STOOLS AND BENCHES

Wavelength[®] Benches Designer - Karim Rashid

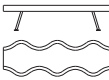
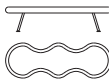
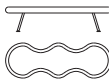
– US Only –

Model Number	Seat H"	W"	D"	H"	Fabric		COM	COL	Verde	Grano	Cremoso	Knoll Textiles						
					Yds.	Sq. Ft.						1	2	3	4			
TWO SEAT BENCH																		
	1404_	16¾	47¼	23½	16¾													
	(Model #1)	Fully Upholstered				1½	24	4,360	4,575	5,345	5,615	5,715	4,535	4,655	4,795	4,930		
	(Model #2)	Fabric seat, fabric contrasting trim				¾	1½	4,360					4,535	4,655	4,795	4,930		
	(Model #3)	Leather seat, leather contrasting trim				12	24		4,575	5,345	5,615	5,715						
	(Model #4)	Fully Upholstered, rounded ends				1¾	28	4,360	4,575	5,345	5,615	5,715	4,565	4,700	4,870	5,025		
	(Model #5)	Fabric seat, fabric contrasting trim, rounded ends				1½	1¾	4,360					4,565	4,700	4,870	5,025		
	(Model #6)	Leather seat, leather contrasting trim, rounded ends				24	28		4,575	5,345	5,615	5,715						
THREE SEAT BENCH																		
	1405_	16¾	70 7/8	23½	16¾													
	(Model #1)	Fully Upholstered				2¼	36	4,820	5,060	6,170	6,535	6,690	5,085	5,265	5,475	5,680		
	(Model #2)	Fabric seat, fabric contrasting trim				2¼	2¼	4,820					5,085	5,265	5,475	5,680		
	(Model #3)	Leather seat, leather contrasting trim				36	36		5,060	5,345	5,615	5,715						
	(Model #4)	Fully Upholstered, rounded ends				2½	40	4,820	5,060	6,170	6,535	6,690	5,110	5,310	5,545	5,770		
	(Model #5)	Fabric seat, fabric contrasting trim, rounded ends				2	2¼	4,820					5,110	5,310	5,545	5,770		
	(Model #6)	Leather seat, leather contrasting trim, rounded ends				32	36		5,060	6,170	6,535	6,690						
OTTOMAN																		
	1406_	16¾	23¾	23½	16¾													
	(Model #1)	Fully Upholstered				1	16	3,495	3,690	3,955	4,070	4,115	3,610	3,690	3,780	3,875		
	(Model #2)	Fabric seat, fabric contrasting trim				¾	½	3,495					3,610	3,690	3,780	3,875		
	(Model #3)	Leather seat, leather contrasting trim				12	8		3,690	3,955	4,070	4,115						

Wavelength Bench passes CAL 133 certified for an upcharge of \$760 list per 2 seat bench, \$930 list per 3 seat bench, \$485 list per ottoman. Certification applies to Nienkämper leathers and fabrics that have a minimum of 50% natural fibre content. COM's and COL's are subject to approval. Add the extension "-CAL" to the model number when ordering.

Wavelength Benches:

- Fabric yardages are based on plain fabrics with no apparent pattern direction. Fabric is railroaded.
- When upholstering in two different fabrics or leathers use the COM price or COL price and ship yardages or square footage as noted on page 7. Most fabrics and vinyl are suitable for the top seat portion but the contrasting trim must have stretch.
- Nienkämper reserves the right to determine the suitability of COM on our furniture. For further details regarding approvals, refer to page 7.
- Specify polished or brushed aluminum frame.

Fabric to be upholstered on Wavelength requires approval from Nienkämper's factory. Please contact customer service at 800 668 9318 for our fabric approval list.

Fabric direction when railroaded

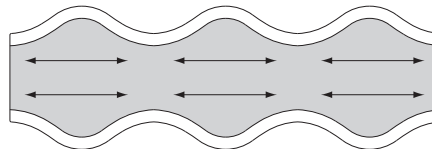

Model #14041
Cast aluminum frame in polished aluminum



Model #14044
Two seat bench, polished aluminum frame





Model #14044
Two seat bench, rounded ends polished aluminum frame



STOOLS AND BENCHES

ZooStool Designer - Mouna & Silvio Russo

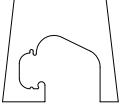
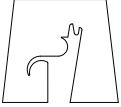
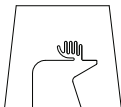
– US Only –

	Model Number	W"	D"	H"	List Price
BISON STOOL					
	20912	11	11	13¼	995
CAT STOOL					
	20911	11	11	13¼	995
DEER STOOL					
	20914	11	11	13¼	995
MAPLE LEAF STOOL					
	20915	11	11	13¼	995
SEAL STOOL					
	20913	11	11	13¼	995

Stackable Zoo Stools are constructed from plywood core with laminate in bold primary colors:

- Cat: yellow (Arborite Daffodil S480-CA)
- Bison: blue (Abet 482SEI)
- Seal: green (Abet 460SEI)
- Deer: orange (Pionite bittersweet S0312)
- Maple Leaf: red (Wilsonart Holly Berry D307-60)

Note: Custom colors and logos available for quantities of 4+

nienkämper

SEATING & MEETING PODS

MEETING PODS



2026

MEETING PODS

Patkau Ice Hut Designer - Patkau Architects

– US Only –

Model Number	W"	D"	H"	Fabric Leather		COM	COL	Verde	Grano	Cremoso	Knoll Textiles			
				Yds.	Sq. Ft.						1	2	3	4

PATKAU ICE HUT

21000	60	60	96	9	162	75,195	78,965	84,975	86,585	88,190	76,180	76,860	77,670	78,445
--------------	----	----	----	---	-----	--------	--------	--------	--------	--------	--------	--------	--------	--------



Model # 21000



MEETING PODS

Toko Designer - Carl Gustav Magnusson

TOKO - SMALL FOOT PRINT

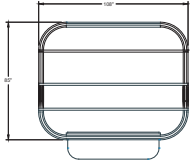

Model Number	W"	D"	H"	List Price
Small Foot Print	85	108	94	*Due to the level of customization offered with Toko meeting pods, pricing must be provided by Nienkämper customer service. This ensures your unique build requirements are met to 100% accuracy and satisfaction. Please contact customer service for more details at 800.668.9318
Medium Foot Print	118	108	94	
Large Foot Print	151	108	94	

TOKO - MEDIUM FOOT PRINT

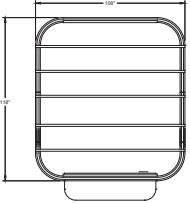

TOKO - LARGE FOOT PRINT

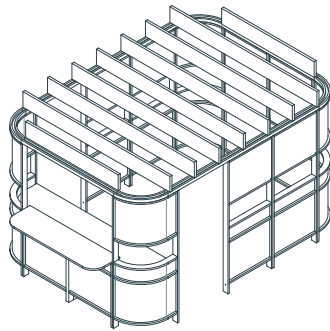
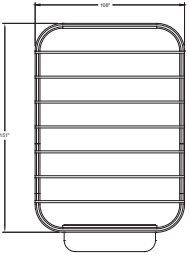

TOKO Meeting Pod - Large Foot Print model

Shown with low sheen solid walnut construction, natural walnut perforated panels, (RL-04) finger print resistant laminate bar top and stone counter top.



Standard Features:

- Modular, solid wood frame construction.
- Choice of 4 insert panel materials and a variety of finish options.
- Serving Counters are available in all standard Nienkämper laminates and Caesar Stone materials.
- Storage drawers and undercounter, doored cases with adjustable shelves.
- Integrated refrigerator and concealed waste receptacle options
- Concealed and counter top power
- Integrated lighting available upon request with upcharge
- Contact Nienkämper customer service for more information and details at 800.668.9318

ADA complaint counter with wheelchair leg space, box drawer, two drawer storage with integrated finger pulls and single drawer fridge shown

