

# nienkämper

## SEATING & MEETING PODS

### PRICE LIST



2026

# TABLE OF CONTENTS

<b>How to Order Nienkämper Seating</b>	<b>4</b>
<b>Upholstery Details</b>	<b>6-11</b>
Nienkämper Leather	5
Customer's Own Material (COM)	6
KnollTextiles	6
Customer's Own Leather (COL)	6
Shipping Your Materials	6
Knoll Textiles Categories and Index	7-8
<b>California Technical Bulletin 133</b>	<b>9</b>
<b>Veneers / Finishes</b>	<b>10</b>
<b>Office Seating</b>	<b>11-23</b>
AYA™	13
Emissary	14
HSC Task	15
Nienkämper NOW®	16-17
Senator® Boardroom	18
Senator® CEO	19
Senator® Executive	20
Senator Mesh Back	21
Slim	22
Trench	23
<b>Side Chairs</b>	<b>24-28</b>
HSC	26
Kush	27
Senator® Nuvo Sled Base	28
<b>Lounge Seating</b>	<b>29-83</b>
Bare	31
BASS Collection	32-33
Bay	34
Beam	35-36
Berkley® Collection	37-42
Blob	43
Carlisle	44
Dobi	45
Dune	46
Elite	47
Gateway™ Lounge	48-53
Godbout	54
Heartbeat	55-56
Isola 8	57
J + J Studio	58

Kloud® Collection	59
Kloud® Serpentine™	60
Leaf	61
Nordic	62
Note	63
Radius	64-65
Rowan	66
Satori™	67
Six® Collection	68
Turnaround® Collection	69
Tuxedo™	70-71
Tuxedo™ Classic	72-75
Tuxedo™ Cove	76-79
Tuxedo™ High Back	80-81
Wavelength®	82-83
<b>Stools and Benches</b>	<b>84-95</b>
Blottoman™	86
Caravite	87
Jackal	88
Kloud® Benches	89
Mint	90
Moment Collection	91
Six Collection® Benches	92
Spin Stool/Tables	93
Wavelength® Benches	94
Zoo Stools	95
<b>Meeting Pods</b>	<b>96-98</b>
Patkau Ice Hut	97
TOKO Meeting Pod	98

# HOW TO ORDER NIENKÄMPER SEATING

## SELECT THE CHAIR:

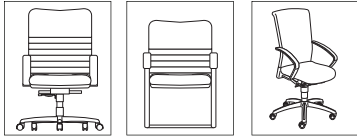

Select the style of chair that best suits your needs. All features are listed on each page.

### Sample:

Standard Features:

- Pneumatic height adjustment
- Back tilt locking mechanism
- Tension control
- Carpet casters
- Black five-star base

### Optional Features:

- Hard floor casters, Black, add \$85 list per chair
- Hard floor casters, Chrome, add \$100 list per chair
- Glides with self return base & pneumatic height adjustment, add \$105 list per chair
- Polished aluminum five-star base, add \$205 list
- Chrome finish sled base, add \$190 list

## SELECT YOUR ARM TYPE:

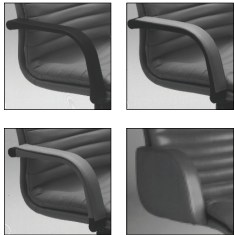

For each style of chair there are a number of arm options. These are listed under the model number with an extension. For example 1411\_ is the model number for the Senator Executive low back chair. Extension #1 specifies Urethane Arm, extension #3 specifies Urethane arm with cap & wrap, and so on.

### Sample:

1411\_

18½"-21½" 25" 25" 26" 36"

(Model #1) Urethane arm

fabric 1¾ Yds. leather 32 Sq. Ft.

(Model #2) Urethane arm with cap

fabric 2 Yds. leather 35 Sq. Ft.

(Model #3) Urethane arm with cap & wrap

fabric 2¼ Yds. leather 37 Sq. Ft.

## SELECT YOUR BASE:



At the end of each chair listing are notes indicating base options and finishes, where applicable. Review these notes and specify your base type and finish at the time you place your order.

### Cross Section Example:

Standard Features:

- Pneumatic height adjustment
- Back tilt locking mechanism
- Tension control
- Carpet casters
- Black five-star base

### Optional Features:

- Hard floor casters, Black, add \$85 list per chair
- Hard floor casters, Chrome, add \$100 list per chair
- Glides with self return base & pneumatic height adjustment, add \$105 list per chair
- Polished aluminum five-star base, add \$205 list
- Chrome finish sled base, add \$190 list

## SELECT YOUR OPTIONS:

Each chair has additional options to choose from, listed on each page.

Optional Features:

- Hard floor casters, Black, add \$85 list per chair
- Hard floor casters, Chrome, add \$100 list per chair
- Glides with self return base & pneumatic height adjustment, add \$105 list per chair
- Polished aluminum five-star base, add \$205 list
- Chrome finish sled base, add \$190 list

## SELECT YOUR FABRIC:

For each chair we have priced COM, COL, Nienkämper's three grades of leather and four grades of KnollTextiles. Refer to the row that corresponds to the chair you are ordering.

For information on COM and COL please refer to page 6.

## UPHOLSTERY DETAILS

---

### **NIENKÄMPER LEATHER:**

Nienkämper is universally known for its exquisite craftsmanship in leather furniture. Nienkämper leather on Nienkämper furniture offers you and your clients the highest quality of materials as well as favorable pricing. Our Verde and Grano leather is available as COL sold to the nearest half hide. Ecopell leather is available for Nienkämper furniture only.

#### **The Verde Collection:**

Available in 8 colors this collection provides a varied selection of neutrals, browns, reds and blues. It is organically tanned using a chrome-free process with a water-based semi-aniline finish. These improved techniques result in a more natural character, combined with a softer touch and brighter colors that are consistent from batch to batch.

Raw Material: Scandinavian Cow Hide

Thickness: 1.1-1.3 mm

Type: Chrome-free tanned with a water-based semi-aniline finish. Full natural grain, excellent durability yet soft and pliable, suitable for public environments. Some visible healed scars add natural character to this leather.

Average Hide Size: 55 sq.ft.

#### **The Grano Collection:**

The perfect balance between strength and softness. Semi-aniline Grano has exceptional natural beauty and pliancy. An easy-to-clean finish makes this leather appropriate for seating in reception areas, meeting rooms and managerial offices.

Raw Material: European Cow Hide

Thickness: 1.2-1.4 mm

Type: Semi-aniline dyed.

Average Hide Size: 55 sq.ft.

#### **The Neather Collection:**

Available in 6 colors, Neather is a synthetic material similar to vinyl . It comes in a standard 54" width. Neather is easy to clean and a good option for accessory or upholstery items.

To request leather samples please contact your local sales representative, for a listing or call Nienkämper Customer Service at 800.668.9318.

# UPHOLSTERY DETAILS

**CUSTOMER'S OWN MATERIALS (COM):**

Nienkämper reserves the right to determine the suitability of a particular COM on our furniture. If we determine, in our judgment, that the COM is inappropriate for use on a particular product we will notify the customer. If you have any questions on the appropriateness of your COM please submit a sample to Customer Service prior to your order.

**KNOLLTEXTILES:**

All Nienkämper seating available in fabric includes pricing for four grades of fabric, see the KnollTextiles grade columns throughout this book. All fabric orders should be made when ordering the furniture. For KnollTextiles samples contact the KnollTextiles Customer Service department at 1.866.565.5858.

All yardage requirements are noted for each model number and option, refer to the pricing charts in this book. All yardage requirements shown in our price list are based on 54" plain material. Fabrics which have a repeat that must be matched, or are less than 54" wide, will require more yardage. Check with Customer Service before ordering. There may be yardage savings for quantity orders of the same model. Check with Customer Service before ordering. ALL COM WILL BE CUT AND APPLIED AT OUR DISCRETION UNLESS SPECIAL CUTTING INSTRUCTIONS ARE INCLUDED IN WRITING WITH THE ORDER. FABRIC PATTERNS SHOULD BE IDENTIFIED AS APPLIED VERTICALLY OR HORIZONTALLY ON A FRAME. WE CANNOT BE HELD RESPONSIBLE FOR RECEIPT OF DEFECTIVE FABRIC AS WE APPLY ALL COM AS FIRST QUALITY GOODS.

Fabric Width	Plain Fabric	2" - 14" Repeat	15" - 24" Repeat	25" - 27" Repeat	28" - 36" Repeat
54"	0%	10%	15%	20%	25%
50"	10%	20%	25%	30%	35%
48"	15%	25%	30%	35%	40%
45"	40%	50%	55%	60%	65%
36"	50%	60%	65%	70%	75%

We cannot be held responsible if yardage supplied is insufficient to complete an order.

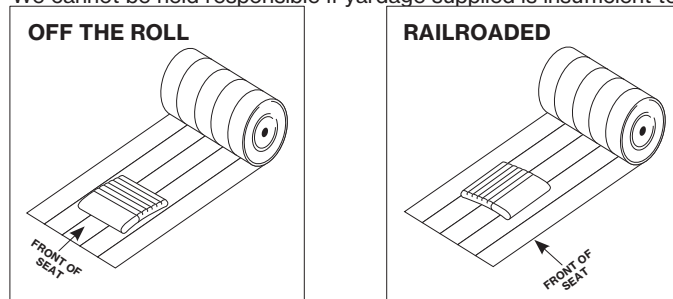

**CUSTOMER'S OWN LEATHER:**

All furniture listed in this price list that is available with leather has pricing in COL, refer to the COL column throughout this book. Leather is applied to avoid scars, however, some markings are inherent in this natural material. Square footage requirements are based on cow hides measuring 50 sq.ft. per hide. Consult Nienkämper's Customer Service Department for square footage requirements before ordering when using hides that do not meet these requirements. Application instructions must accompany all COL orders. In the absence of these instructions Nienkämper will determine the best method of upholstery.

**SHIPPING YOUR MATERIALS:**

For Canada  
Customer supplied material must be sent prepaid to:

Nienkämper International, Inc.  
257 Finchdene Square  
Toronto, Ontario  
Canada M1X 1B9

From all locations outside of Canada  
Customer supplied material must be sent prepaid to:

Willson International Limited  
c/o Nienkämper  
257 Finchdene Square  
Toronto, Ontario  
Canada M1X 1B9

All packages must include a copy of a commercial invoice showing the exact yardage, value and fibre content of the fabric and must indicate our order confirmation number, or customer's purchase order number, and the furniture for which it is intended.

# UPHOLSTERY DETAILS

An index of KnollTextiles fabric follows. Contact KnollTextiles customer service at 1.800.237.1625 for an updated listing. For fabric not graded in, please contact customer service for pricing.

## ALPHABETICAL INDEX:

Category 1	
Fabric Name	Pattern #
Attire	466933
Boundary*	466735
Brigadoon*	466914
Chameleon*	466929
Commuter Cloth	466879
Contour*	466950
Cozy Cord*	466938
Crossroad	466672
Delite	466730
Diva	466722
Dottie	466799
Facet*	466804
Ferry	466850
Hourglass	466846
Infinite	466734
Instinct	466921
Journey	466866
Keaton	466851
Knoll Hopsack	466729
Little Devil	466916
Oh La La	466671
Olympia	466808
Plaid On*	466947
Prairie*	466762
Puff	466726
Shadow Play*	466759
Sonnet	466909
Summit	466694
Tinge*	466721
Topos*	466800
Utopia*	466867
Vast*	466945
Venue	466756
Vibe II*	466718
Westwood*	466757
Wild Thing*	466779
Winnow*	466960

Category 2	
Fabric Name	Pattern #
Atlas*	466702
Aurora, 1985	466954
Buzz	466719
Caliper*	466804
Circle Point*	466942
Cleo	466910
Code	466736
Color Field*	466712
Currents*	466951
Dactyl*	466673
Day Tripper	466913
Durand*	466895
Entwine	466937
Flower Power	466946
Greenwich*	466878
Homage*	466943
Hummingbird	466956
Island*	466765
Kiln*	466965
Knoll Felt	466830
Off the Grid	466725
Palisade*	466763
Pathway*	466941
Pico	466968
Placid*	466949
Premier*	466920
Prestini*	466953
Pullman	466917
Rebel	466922
Retreat*	466944
Seurat	466811
Smart*	466853
Tempest	466724
Utmost II	466931
Vice Versa*	466925
Whip*	466842
Woodland II*	466723
Wow Factor	466720

Category 3	
Fabric Name	Pattern #
Aegean	466769
Alter Ego	466792
Arrondissement	466711
Biscayne	466890
Cameo	466674
Circa	466753
Classic Boucle	466777
Color Collage	466716
Eclat Weave	466773
Fancy Twill	466717
Imprint	466923
In Stitches	466908
It's Complicated*	466771
Looped In	466948
Mococco, 1966	466967
Modern Tweed	466795
Nature Walk*	466770
Rivers	466806
Sherman	466841
Texnet*	466760
Vert	466955

Category 4	
Fabric Name	Pattern #
Altiplano	466974
Amore	466905
Arezzo	466776
Atelier	466882
Catwalk	466907
Chiseled	466919
Dapper	466803
Firefly	466901
Floressence	466924
In Step	466928
Rivington	466939
Stretch Appeal	466871
Striae Stripe	466930
Stripe It*	466683
Tara	466926
Ultrasuede	466793
Utrillo	466945

Not Graded In	
Fabric Name	Pattern #
Byron	466710
Cato	466862
Chic	466934
Cummings	466709
Digi Velvet	466816
Daily	466807
Dynamic	466845
Guisse	466727
Ita	466693
Knoll Velvet	466780
Limani	466906
Lowell	466707
North Island	466704
Sandis	466915

NOTE: Fabric with "\*" is Bleach Cleanable with diluted household bleach.

## FABRIC DETAILS

An index of KnollTextiles follows. Contact KnollTextiles customer service at 1.800.237.1625 for an updated listing. For fabric not graded in, please contact customer service for pricing.

### NUMERICAL INDEX:

Category 1	
Fabric Name	Pattern #
Oh La La	466671
Crossroad	466672
Summit	466694
Vibe II*	466718
Tinge*	466721
Diva	466722
Puff	466726
Knoll Hopsack	466729
Delite	466730
Infinite	466734
Boundary*	466735
Venue	466756
Westwood*	466757
Shadow Play*	466759
Prairie*	466762
Wild Thing*	466779
Dottie	466799
Topos*	466800
Facet*	466804
Olympia	466808
Hourglass	466846
Ferry	466850
Keaton	466851
Journey	466866
Utopia*	466867
Commuter Cloth	466879
Sonnet	466909
Brigadoon*	466914
Little Devil	466916
Instinct	466921
Chameleon*	466929
Attire	466933
Cozy Cord*	466938
Vast*	466945
Plaid On*	466947
Contour*	466950
Winnow*	466960

Category 2	
Fabric Name	Pattern #
Dactyl*	466673
Atlas*	466702
Color Field*	466712
Buzz	466719
Wow Factor	466720
Woodland II*	466723
Tempest	466724
Off the Grid	466725
Code	466736
Palisade*	466763
Island*	466765
Caliper*	466804
Seurat	466811
Knoll Felt	466830
Whip*	466842
Smart*	466853
Greenwich*	466878
Durand*	466895
Cleo	466910
Day Tripper	466913
Pullman	466917
Premier*	466920
Rebel	466922
Vice Versa*	466925
Utmost II	466931
Entwine	466937
Pathway*	466941
Circle Point*	466942
Homage*	466943
Retreat*	466944
Flower Power	466946
Placid*	466949
Currents*	466951
Prestini*	466953
Aurora, 1985	466954
Hummingbird	466956
Kiln*	466965
Pico	466968

Category 3	
Fabric Name	Pattern #
Cameo	466674
Arrondissement	466711
Color Collage	466716
Fancy Twill	466717
Circa	466753
Texnet*	466760
Aegean	466769
Nature Walk*	466770
It's Complicated*	466771
Eclat Weave	466773
Classic Boucle	466777
Alter Ego	466792
Modern Tweed	466795
Rivers	466806
Sherman	466841
Biscayne	466890
In Stitches	466908
Imprint	466923
Looped In	466948
Vert	466955
Mococco, 1966	466967

Category 4	
Fabric Name	Pattern #
Stripe It*	466683
Arezzo	466776
Ultrasuede	466793
Dapper	466803
Stretch Appeal	466871
Atelier	466882
Firefly	466901
Amore	466905
Catwalk	466907
Chiseled	466919
Florescence	466924
Tara	466926
In Step	466928
Striae Stripe	466930
Rivington	466939
Utrillo	466945
Altiplano	466974

Not Graded In	
Fabric Name	Pattern #
Ita	466693
North Island	466704
Lowell LUXE	466707
Cummings	466709
Byron	466710
Guise	466727
Knoll Velvet	466780
Doily	466807
Digi Velvet	466816
Dynamic	466845
Cato	466862
Limani	466906
Sandis	466915
Chic	466934

**NOTE:** Fabric with "\*" is Bleach Cleanable with diluted household bleach.

# CALIFORNIA TECHNICAL BULLETIN 133

---

All chairs utilize California Bulletin 117 approved fire retardant, CFC-free polyurethane foam.

California 133 - Nienkämper seating designs can be manufactured to meet California Technical Bulletin 133. Certification applies to Nienkämper leathers and fabrics that have a minimum 50% natural fibre content. COM/COL's must be evaluated on an individual basis which may require testing of fabric on the furniture. Testing may require additional cost and lead time.

-Cost of testing a chair is \$950 NET, plus cost of product.

-Additional lead time for testing is 6 weeks.

-See individual product pages for seating that has been tested, applicable upcharge for CAL 133 stated on product page.

Boston Fire Code - Boston has adopted California 133 standards. All information pertaining to California Technical Bulletin 133 as stated above satisfies the Boston Fire Code.

<b>CAL 133 Available</b>	<b>Page</b>
<b>Office Seating:</b>	
Nienkämper NOW® .....	19-25
Senator® Boardroom .....	26
Senator® CEO .....	27
Senator® Executive .....	28
<b>Lounge Seating:</b>	
Berkley® Collection.....	45-50
Blob™ .....	51
Carlisle.....	52
Kloud Collection .....	61
Satori™ .....	69
Six® Collection .....	70
Tuxedo™ .....	72-73
Tuxedo™ Classic .....	74-77
Tuxedo™ High Back.....	82-83
Wavelength® .....	84-85
<b>Benches:</b>	
Blottoman .....	88
Six® Bench .....	94
Wavelength® Bench .....	96

Note: Add the extension “-CAL” at the end of each model number for each chair ordered as CAL 133 certified. For example, a Senator Executive, low back chair on casters with urethane arm, CAL 133 certified would be Model # 14111-CAL.

## VENEERS

All wood surfaces are protected with a durable polyurethane clear lacquer with UV inhibitor. This finish is known for its exceptional durability, as well as abrasion, chemical, impact and scratch resistance. Standard sheen level is 45 degrees. Optional matte, 5, 10 and 35 degree sheen levels are available on request at no additional cost.

Wood Species	Order Code	Veneer/Stain	Upcharge
Maple	F-01	Natural Maple	No upcharge applies.
	F-02	Natural Curly Maple - Rotary Cut	Add 15%.
	F-03	Natural Bird's Eye Maple - Rotary Cut	Call Customer Service for pricing.
	F-04	Maple Stained Pear	No upcharge applies.
Cherry	F-05	Natural Cherry	No upcharge applies.
	F-06	Standard Cherry	No upcharge applies.
	F-07	Cherry Stained Amber	No upcharge applies.
	F-08	Cherry Stained Auburn	No upcharge applies.
	F-09	Cherry Stained Burgundy	No upcharge applies.
Mahogany	F-10	Light Mahogany	No upcharge applies.
	F-11	Medium Mahogany	No upcharge applies.
	F-12	Dark Mahogany	No upcharge applies.
	F-13	Red Mahogany	No upcharge applies.
Anagre	F-14	Natural Figured Anagre - Qtr. Cut Book-Match	Add 15%.
	F-15	Figured Anagre Stained Amber - Qtr. Cut Book-Match	Add 15%.
Sycamore	F-16	Natural Figured Sycamore - Qtr. Cut Book-Match	Add 15%.
Walnut	F-17	Burnt Walnut	No upcharge applies.
	F-19	Natural Walnut- Flat Cut Book-Match	No upcharge applies.
	F-19FM	Natural Walnut- Flat Cut Book-Match (matte sheen)	No upcharge applies.
	F-27F	Creamy Walnut- Flat Cut Book-Match (10° sheen)	No upcharge applies.
	F-27R	Creamy Walnut - Rift Cut Slip-Match (10° sheen)	Add 5%
	F-28	Tawny Walnut	No upcharge applies.
	F-31FM	Autumn Walnut- Flat Cut Book-Match (matte sheen)	No upcharge applies.
	F-31RM	Autumn Walnut - Rift Cut Slip-Match (matte sheen)	Add 5%
Oak	F-18F	Natural White Oak - Flat Cut Book-Match (10° sheen)	No upcharge applies.
	F-18R	Natural White Oak - Rift Cut Slip-Match (10° sheen)	Add 5%
	F-26	Charcoal Ash On Oak- Flat Cut Book- Match (10° sheen)	No upcharge applies.
	F-29F	Smoky Oak - Flat Cut Book-Match	No upcharge applies.
	F-29R	Smoky Oak - Rift Cut Slip-Match	Add 5%
	F-29FM	Smoky Oak - Flat Cut Book-Match (matte sheen)	No upcharge applies.
	F-29RM	Smoky Oak - Rift Cut Slip-Match (matte sheen)	Add 5%
	F-30FM	Whisper White Oak - Flat Cut Book-Match (matte sheen)	No upcharge applies.
	F-30RM	Whisper White Oak - Rift Cut Slip-Match (matte sheen)	Add 5%
	F-32FM	Cotton White Oak - Flat Cut Book-Match (matte sheen)	No upcharge applies.
	F-32RM	Cotton White Oak - Rift Cut Slip-Match (matte sheen)	Add 5%
Sapele – Ribbon Stripe	F-20	Natural Ribbon Strip Sapele - Qtr. Cut Slip-Match	No upcharge applies.
Moabi (Cherry substitute)	F-21	Natural Moabi - Quarter - Qtr. Cut Book-Match	No upcharge applies.
Cape Coast Walnut	F-22	Dark Cape Coast Walnut - Qtr. Cut Slip-Match	No upcharge applies.
	F-23	Natural Cape Coast Walnut - Qtr. Cut Slip-Match	No upcharge applies.
	F-23	Natural Cape Coast Walnut - Qtr. Cut Slip-Match	No upcharge applies.
Ash	F-25	Slate Gray Ash - Qtr. Cut Slip-Match	No upcharge applies.

### VENEER GRAIN OPTIONS

Nienkämper products utilize the best quality veneers available, and, combined with Nienkämper's patented veneering systems, create work environments of incredible quality and beauty.

All veneer furniture comes standard with flat cut book-match veneer; flat cut slip-match veneer can also be specified. Quarter cut slip-match and quarter cut book-match veneers are available at a 5% upcharge. Figured Anagre and Figured Sycamore veneers are Quarter cut book-matched. Bird's Eye Maple and Curly Maple are rotary cut. Facet Edge, Taper edge, Flowform, Camber and Self edge tops with veneer are manufactured with a solid wood edge. All edges are then veneer wrapped to create a seamless profile top.

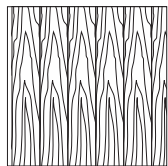

Standard V1  
Flat Cut Book-Match

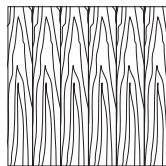

Flat Cut Slip-Match V2

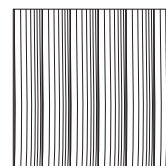

Quarter Cut Slip-Match V3  
Add 5%

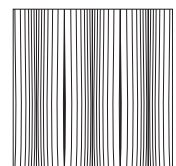

Quarter Cut Book-Match V4  
Add 5%

# nienkämper

## SEATING & MEETING PODS

OFFICE SEATING



2026

# OFFICE SEATING

## TABLE OF CONTENTS

---

<b>Office Seating</b>	<b>11-23</b>
AYA™	13
Emissary	14
HSC Task Chair	15
Nienkämper NOW®	16-17
Senator® Boardroom	18
Senator® CEO	19
Senator® Executive	20
Senator® Mesh Back	21
Slim	22
Trench	23

# OFFICE SEATING

AYA™ Designer - Mark Saffell and David Ritch

— CND Only —

KnollTextiles

Model Number	Seat H"	Arm H"	W"	D"	H"	Fabric Yds.	Leather Sq. Ft.	COM	COL	Verde	Grano	Cre moso	1	2	3	4
<b>MEDIUM BACK</b>																
	<b>13301</b>	Black Base														
	18- 21	24-27	26½	26	36-39	1¼	28	2,580	2,710	3,430	3,705	3,805	2,835	3,045	3,215	3,550
	<b>13302</b>	Polished Aluminum with Black Casters														
	18- 21	24-27	26½	26	36-39	1¼	28	2,715	2,855	3,580	3,845	3,935	2,975	3,185	3,350	3,690
	<b>13305</b>	Polished Aluminum with Chrome Casters														
	18- 21	24-27	26½	26	36-39	1¼	28	2,745	2,880	3,605	3,870	3,960	3,000	3,210	3,380	3,715

## HIGH BACK

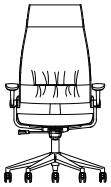

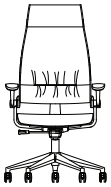
	<b>13303</b>	Black Base														
	18- 21	24-27	26½	26	45-48	2	34	3,245	3,400	4,285	4,615	4,720	3,540	3,780	3,970	4,355
	<b>13304</b>	Polished Aluminum with Black Casters														
	18- 21	24-27	26½	26	45-48	2	34	3,390	3,530	4,435	4,770	4,865	3,685	3,925	4,115	4,495
	<b>13306</b>	Polished Aluminum with Chrome Casters														
	18- 21	24-27	26½	26	45-48	2	34	3,410	3,580	4,460	4,790	4,900	3,705	3,945	4,135	4,515

Model # 13305  
Medium Back

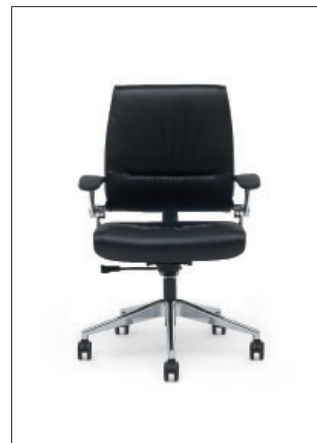

The ultimate in ergonomic elegance, the AYA™ Chair is based on the principles of natural body motion when reclining. The simplicity of function uses the occupant's own weight to control the seating position. As you recline and stop, the chair will stay in that position. There is no tension control, as the weight of the occupant rides up a ten degree incline, using gravity as the resistance and friction as the position control. There is only one control on the chair which adjusts height and locks the seat in one of five positions.

# OFFICE SEATING

Emissary Chair Designer – Aaron Duke

– CND Only –

Model Number	Seat H"	Arm H"	W"	D"	H"	Fabric Yds.	Leather Sq. Ft.	COM	COL	Neather	Verde	Grano	Cremoso	KnollTextiles			
														1	2	3	4

## EMISSARY LOW BACK



<b>10061</b>	18½-21	25-28	25	24	39-42	1¼	32	2,645	2,785	2,845	3,735	3,935	4,040	2,900	3,110	3,280	3,615
--------------	--------	-------	----	----	-------	----	----	-------	-------	-------	-------	-------	-------	-------	-------	-------	-------

## EMISSARY MEDIUM BACK



<b>10062</b>	18½-21½	25-28	25	24	44-47	2	36	2,660	2,800	2,885	3,870	4,090	4,210	2,955	3,195	3,385	3,765
--------------	---------	-------	----	----	-------	---	----	-------	-------	-------	-------	-------	-------	-------	-------	-------	-------

## EMISSARY HIGH BACK



<b>10063</b>	18½-21½	25-28	25	24	49-52	2¼	41	2,685	2,825	2,925	4,050	4,295	4,430	3,015	3,285	3,505	3,935
--------------	---------	-------	----	----	-------	----	----	-------	-------	-------	-------	-------	-------	-------	-------	-------	-------

### Standard Features:

- Rigid polyurethane inner shell
- Over molded with soy based flexible polyurethane foam
- Pneumatic height adjustment
- Back tilt locking mechanism
- Carpet casters
- Black five-star base & casters
- Leather upholstered arm cap
- For chair with COM & KnollTextiles upholstery finish, leather upholstered arm cap is available in Nienkämper Verde/Grano/Cremoso leather

### Optional Features:

- Hard floor casters, black, add \$85 list per chair
- Glides with self return base & pneumatic height adjustment, add \$105 list per chair
- Polished aluminum five-star base with chrome casters, add \$205 list

Model # 10063



Emissary high back chair fully upholstered in Cremoso leather, black CM795 with polished chrome base

# SIDE CHAIRS

HSC Designer - HUB Design Studio

— CND Only —

Model Number	Seat H"	W"	D"	H"	Fabric Yds.	Leath- er Sq. Ft.	Knoll Textiles			
							COM	COL	Neather Verde	Grano Cremoso

## HSC CHAIR ON CASTER BASE



<b>38803</b>	17-20	25¾	24	31-34	2½	45	2,035	2,140	2,280	3,395	3,630	3,745	2,400	2,700	2,940	3,420
--------------	-------	-----	----	-------	----	----	-------	-------	-------	-------	-------	-------	-------	-------	-------	-------

### Standard Features:

- Seat depth: 18"; Seat width: 20½"
- Molded foam frame with flexible foam on seat and back.
- 5 star caster base is standard in mirror polished finish with chrome carpet casters.
- Pneumatic height adjustment and back tilt locking mechanism are standard features for caster base.

Model #38803



**OFFICE SEATING**

Nienkämper NOW® Chair Designer - Mark Müller

– CND Only –



Fixed Aluminum Arm Supports – Polished Finish  
(Available in Black Paint)



Multifunctional Armrest

Multifunctional Arm Adjustments



Depth Adjustment  
• 5 Positions  
• 2" Range of Motion



Height Adjustment  
• 12 Positions  
• 4 3/8" Range of Motion



Swivel Adjustment  
• Left Swivel = 15°  
• Right Swivel = 15°



Width Adjustment  
• 3 Positions  
• Interior Arm Clearance= 18 1/2" to 20 3/4" (Can be increased up to 20 1/2" to 22 3/4")



Black Glides (Plastic)  
Available with Self-Return Base



Chrome Glides  
Available with Self-Return Base



75mm Black Plastic Casters  
Also available with soft-wheel









75mm Casters  
(Chrome Centre Strip)  
Also available with soft wheel, or Electrical Static Discharge version







# OFFICE SEATING

Nienkämper NOW® Chair Designer - Mark Müller



– CND Only –

Model Number	Seat H"	Arm H"	W"	D"	H"	Fabric Yds.	Leather Sq. Ft.	COM	COL	Neather	Verde	Grano	Cremoso	Knoll Textiles			
														1	2	3	4
<b>FULLY UPHOLSTERED</b>																	
Pneumatic Height Adjustment on Casters																	
	<b>13050</b>	Black Painted Arm Supports, Black Plastic Base, Black Casters															
	18-21	24½-27½	26	25	36½-39½	1¼	28	1,730	1,765	1,920	2,575	2,845	2,955	1,985	2,195	2,365	2,700
	<b>13052</b>	Black Painted Arm Supports, Polished Alum. Base, Chrome Casters															
	18-21	24½-27½	26	25	36½-39½	1¼	28	<b>1,930</b>	<b>1,970</b>	<b>2,290</b>	<b>2,770</b>	<b>3,045</b>	<b>3,150</b>	<b>2,185</b>	<b>2,395</b>	<b>2,565</b>	<b>2,900</b>
	<b>13024</b>	Polished Arm Supports, Black Plastic Base, Black Casters															
	18-21	24½-27½	26	25	36½-39½	1¼	28	1,810	1,850	2,005	2,645	2,920	3,015	2,065	2,275	2,445	2,780
	<b>13022</b>	Polished Arm Supports, Polished Alum. Base, Chrome Casters															
	18-21	24½-27½	26	25	36½-39½	1¼	28	<b>2,010</b>	<b>2,045</b>	<b>2,190</b>	<b>2,845</b>	<b>3,125</b>	<b>3,225</b>	<b>2,265</b>	<b>2,475</b>	<b>2,645</b>	<b>2,980</b>
	<b>13058</b>	Multifunctional Armrests, Black Plastic Base, Black Casters															
	18-21	24½-27½	27½	25	36½-39½	1¼	28	1,730	1,765	1,925	2,575	2,845	2,955	1,985	2,195	2,365	2,700
	<b>13060</b>	Multifunctional Armrests, Polished Alum. Base, Chrome Casters															
	18-21	24½-27½	27½	25	36½-39½	1¼	28	<b>1,930</b>	<b>1,970</b>	<b>2,130</b>	<b>2,770</b>	<b>3,045</b>	<b>3,150</b>	<b>2,185</b>	<b>2,395</b>	<b>2,565</b>	<b>2,900</b>

Pneumatic Height Adjustment on Glides

	<b>13062</b>	Black Painted Arm Supports, Black Plastic Base, Black Glides														
	18-21	24½-27½	26	25	36½-39½	1¼	28	1,690	1,720	1,870	2,510	2,795	2,890	1,945	2,155	2,325
	<b>13064</b>	Black Painted Arm Supports, Polished Alum. Base, Chrome Glides														
	18-21	24½-27½	26	25	36½-39½	1¼	28	<b>1,840</b>	<b>1,885</b>	<b>2,025</b>	<b>2,670</b>	<b>2,960</b>	<b>3,060</b>	<b>2,095</b>	<b>2,305</b>	<b>2,475</b>
	<b>13028</b>	Polished Arm Supports, Black Plastic Base, Black Glides														
	18-21	24½-27½	26	25	36½-39½	1¼	28	1,755	1,805	1,940	2,595	2,870	2,970	2,015	2,225	2,390
	<b>13027</b>	Polished Arm Supports, Polished Alum. Base, Chrome Glides														
	18-21	24½-27½	26	25	36½-39½	1¼	28	<b>1,920</b>	<b>1,945</b>	<b>2,115</b>	<b>2,750</b>	<b>3,035</b>	<b>3,130</b>	<b>2,175</b>	<b>2,385</b>	<b>2,555</b>
	<b>13070</b>	Multifunctional Armrests, Black Plastic Base, Black Glides														
	18-21	24½-27½	27½	25	36½-39½	1¼	28	1,690	1,720	1,870	2,510	2,795	2,890	1,945	2,155	2,325
	<b>13072</b>	Multifunctional Armrests, Polished Alum. Base, Chrome Glides														
	18-21	24½-27½	27½	25	36½-39½	1¼	28	<b>1,840</b>	<b>1,885</b>	<b>2,035</b>	<b>2,670</b>	<b>2,960</b>	<b>3,060</b>	<b>2,095</b>	<b>2,305</b>	<b>2,475</b>

Self-Return Jury Base with Pneumatic Height Adjustment

	<b>13074</b>	Black Painted Arm Supports, Black Aluminum Jury Base														
	18-22	24½-27½	26	25	36½-40½	1¼	28	1,905	1,995	2,055	2,670	2,890	3,015	2,160	2,370	2,540
	<b>13076</b>	Polished Painted Arm Supports, Black Aluminum Jury Base														
	18-22	24½-27½	26	25	36½-40½	1¼	28	<b>1,940</b>	<b>2,040</b>	<b>2,125</b>	<b>2,720</b>	<b>2,975</b>	<b>3,070</b>	<b>2,195</b>	<b>2,405</b>	<b>2,575</b>
	<b>13078</b>	Multifunctional Armrest, Black Aluminum Jury Base														
	18-22	24½-27½	27½	25	36½-40½	1¼	28	1,915	2,005	2,060	2,670	2,950	3,040	2,170	2,380	2,550

**Nienkämper NOW chair passes CAL 133 certified for an upcharge of \$390 list per chair. Certification applies to Nienkämper leathers and fabrics that have a minimum of 50% natural fibre content. COM's and COL's are subject to approval. Add the extension "-CAL" to the model number when ordering.**

The Nienkämper NOW® Chair brings Nienkämper's renowned fine upholstery and contemporary aesthetics to the conference-room chair. Height, back and tilt controls, firm lumbar support and a contoured back ensure a comfortable, ergonomic sitting experience. Top stitching on the edges, a distinctive Y detail on the back and a tuck on the seat and back emphasize the chair's crisp, tailored elegance.

### Standard Features:

- Locking tilt with return safety function
- Pneumatic height adjustment
- Synchronized seat-and-back recline
- Tilt tension control
- Top-stitch detail on seat and back covers
- Jury base for auditorium seating
- Large 75mm, unhooded, hard wheel casters (for soft flooring)
- Chrome (zinc) or black (plastic) glides
- 26" diameter five-star base

Suffix	Optional Features:	
"A"	• Armless (remove painted arm supports)	(deduct \$160 list)
"B"	• Verde, Grano or Cremoso leather upholstered arm pads (for painted or polished arm supports)	(add \$190 list)
	- plus additional 3 sq.ft. of COL	
"C"	• Verde, Grano or Cremoso leather upholstered arm pads & panels (remove painted arm supports)	(add \$575 list)
	- plus additional 11 sq.ft. of COL	
"D"	• Contrast stitching (leather covers only)	(no upcharge)
"CAL"	• CAL 133 Certified applies to leather & fabric that has a minimum 50% natural fibre content. COM & COL subject to approval.	(add \$390 list)
<b>Caster Chair Options:</b>		
"E"	• Soft wheel caster (for hard floors); Black	(add \$85 list)
"F"	• Soft wheel caster (for hard floors); Chrome	(add \$100 list)
"G"	• Hard wheel Electrical Static Discharge (ESD) caster; Chrome (for soft flooring)	(add \$150 list)
"H"	• Fixed-height cylinder (no height adjustment, with swivel)	(no upcharge)
<b>Glide Chair Options:</b>		
"I"	• Self-Return Base with Pneumatic Height Adjustment	(add \$105 list)

# OFFICE SEATING

Senator® Boardroom Designer – Nienkämper

– CND Only –

Model Number	Seat H"	Arm		D"	H"	Fabric Yds.	Leather Sq. Ft.	COM	COL	Neather	Verde	Grano	Cremoso	Knoll Textiles			
		H"	W"											1	2	3	4
<b>LOW BACK</b>																	
 <b>1464_</b>	18½-21½	25	25	25	36												
<b>(Model #1)</b>	Urethane arm					1¼	22	<b>2,185</b>	<b>2,285</b>	<b>2,345</b>	<b>3,090</b>	<b>3,330</b>	<b>3,435</b>	<b>2,445</b>	<b>2,655</b>	<b>2,820</b>	<b>3,160</b>
<b>(Model #9)</b>	Urethane arm with wrap					1½	24	2,415	2,550	2,595	3,465	3,725	3,835	2,640	2,815	2,965	3,250
<b>(Model #2)</b>	Urethane arm with cap					1½	24	<b>2,415</b>	<b>2,550</b>	<b>2,595</b>	<b>3,465</b>	<b>3,725</b>	<b>3,835</b>	<b>2,640</b>	<b>2,815</b>	<b>2,965</b>	<b>3,250</b>
<b>(Model #3)</b>	Urethane arm with cap and wrap					1¾	26	2,485	2,615	2,710	3,610	3,915	4,015	2,745	2,955	3,120	3,455

## MEDIUM BACK

 <b>1465_</b>	18½ - 21½	25	25	40½													
<b>(Model #1)</b>	Urethane arm					1¼	30	<b>2,225</b>	<b>2,335</b>	<b>2,365</b>	<b>3,450</b>	<b>3,775</b>	<b>3,915</b>	<b>2,405</b>	<b>2,560</b>	<b>2,680</b>	<b>2,915</b>
<b>(Model #9)</b>	Urethane arm with wrap					1½	32	2,440	2,575	2,640	3,775	4,115	4,250	2,660	2,835	2,985	3,275
<b>(Model #2)</b>	Urethane arm with cap					1½	32	<b>2,440</b>	<b>2,575</b>	<b>2,640</b>	<b>3,775</b>	<b>4,115</b>	<b>4,250</b>	<b>2,660</b>	<b>2,835</b>	<b>2,985</b>	<b>3,275</b>
<b>(Model #3)</b>	Urethane arm with cap and wrap					1¾	34	2,535	2,650	2,740	3,845	4,200	4,340	2,790	3,000	3,170	3,505

## HIGH BACK

 <b>1466_</b>	18½ - 21½	25	25	45													
<b>(Model #1)</b>	Urethane arm					1¼	36	<b>2,260</b>	<b>2,370</b>	<b>2,440</b>	<b>3,545</b>	<b>3,875</b>	<b>4,005</b>	<b>2,445</b>	<b>2,595</b>	<b>2,715</b>	<b>2,955</b>
<b>(Model #9)</b>	Urethane arm with wrap					1¾	38	2,495	2,640	2,720	3,870	4,225	4,365	2,755	2,965	3,130	3,465
<b>(Model #2)</b>	Urethane arm with cap					1¾	38	<b>2,495</b>	<b>2,640</b>	<b>2,670</b>	<b>3,735</b>	<b>4,065</b>	<b>4,200</b>	<b>2,755</b>	<b>2,965</b>	<b>3,130</b>	<b>3,465</b>
<b>(Model #3)</b>	Urethane arm with cap and wrap					2	40	2,585	2,710	2,835	3,950	4,300	4,465	2,880	3,120	3,310	3,695

Senator Boardroom series is available as CAL 133 certified for an upcharge of \$390 list per chair. Certification applies to Nienkämper leathers and fabrics that have a minimum of 50% natural fibre content. COM's and COL's are subject to approval. Add the extension "-CAL" to the model number when ordering.

### Specify model number for arm selection.

#### Standard Features:

- Pneumatic height adjustment
- Back tilt locking mechanism
- Back tilt tension control
- Carpet casters
- Black five-star base

#### Optional Features:

- Hard floor casters, Black, add \$85 list per chair
- Glides, add \$105 list per chair
- Polished aluminum five-star base with chrome casters, add \$205 list

Model # 14652  
Medium Back



Model # 14652  
Medium Back



# OFFICE SEATING

Senator® CEO Designer – Nienkämper

– CND Only –

Model Number	Seat H"	Arm H"	W"	D"	H"	Fabric Yds.	Leather Sq. Ft.	COM	COL	Verde	Grano	Cremoso	Knoll Textiles						
													1	2	3	4			
<b>LOW BACK</b>																			
1461__	18½-21½	25	25	28	36														
(Model #1) Urethane arm						2	34	3,225	3,385	4,550	4,900	5,030	3,520	3,760	3,950	4,335			
(Model #9) Urethane arm with wrap						2¼	37	3,475	3,635	4,950	5,345	5,505	3,805	4,070	4,290	4,720			
(Model #2) Urethane arm with cap						2¼	27	3,475	3,635	4,950	5,345	5,505	3,805	4,070	4,290	4,720			
(Model #3) Urethane arm with cap and wrap						2½	39	3,570	3,730	5,205	5,635	5,815	3,940	4,240	4,480	4,960			
(Model #8) Closed arm						2¾	44	3,955	4,160	5,775	6,250	6,440	4,360	4,690	4,955	5,480			

## MEDIUM BACK

1462__	18½-21½	25	25	28	40½														
(Model #1) Urethane arm						2¼	38	3,375	3,530	4,850	5,260	5,400	3,705	3,970	4,190	4,620			
(Model #9) Urethane arm with wrap						2½	41	3,595	3,775	5,260	5,695	5,865	3,960	4,260	4,500	4,980			
(Model #2) Urethane arm with cap						2½	41	3,595	3,775	5,260	5,695	5,865	3,960	4,260	4,500	4,980			
(Model #3) Urethane arm with cap and wrap						2¾	43	3,700	3,875	5,510	5,985	6,185	4,105	4,435	4,695	5,220			
(Model #8) Closed arm						3	48	4,080	4,295	6,055	6,585	6,805	4,525	4,880	5,170	5,745			

## HIGH BACK

1463__	18½-21½	25	25	28	45														
(Model #1) Urethane arm						2½	40	4,015	4,220	5,680	6,110	6,295	4,380	4,680	4,920	5,400			
(Model #9) Urethane arm with wrap						2¾	43	3,475	4,475	6,100	6,555	6,760	3,875	4,210	4,470	4,995			
(Model #2) Urethane arm with cap						2¾	43	4,275	4,475	6,100	6,555	6,760	4,680	5,010	5,275	5,800			
(Model #3) Urethane arm with cap and wrap						3	45	4,360	4,575	6,350	6,860	7,080	4,800	5,160	5,445	6,025			
(Model #8) Closed arm						3¼	50	4,770	5,005	6,920	7,465	7,690	5,245	5,635	5,950	6,570			

Senator CEO series is available as CAL 133 certified for an upcharge of \$390 list per chair. Certification applies to Nienkämper leathers and fabrics that have a minimum of 50% natural fibre content. COM's and COL's are subject to approval. Add the extension "-CAL" to the model number when ordering.

Specify model number for arm selection.

### Standard Features:

- Pneumatic height adjustment
- Back tilt locking mechanism
- Back tilt tension control
- Carpet casters
- Black five-star base

### Optional Features:

- Hard floor casters, Black, add \$85 list per chair
- Glides, add \$105 list per chair
- Polished aluminum five-star base with chrome casters, add \$205 list





Model # 14622  
Medium Back





# OFFICE SEATING

Senator® Executive Designer – Nienkämper



– CND Only –

Model Number	Seat H"	Arm				Fabric		Leather				Knoll Textiles						
		H"	W"	D"	H"	Yds.	Sq. Ft.	COM	COL	Neather	Verde	Grano	Cremoso	1	2	3	4	
<b>LOW BACK</b>																		
 	<b>1411_</b>	18½ - 21½	25	25	26	36												
<b>(Model #1)</b>	Urethane arm						1¼	32	<b>2,980</b>	<b>3,130</b>	<b>3,200</b>	<b>4,300</b>	<b>4,655</b>	<b>4,795</b>	<b>3,235</b>	<b>3,445</b>	<b>3,615</b>	<b>3,950</b>
<b>(Model #2)</b>	Urethane arm with cap						2	35	3,225	3,385	3,475	4,680	5,050	5,200	3,520	3,760	3,950	4,335
 	<b>(Model #3)</b>	Urethane arm with cap & wrap					2¼	37	<b>3,280</b>	<b>3,465</b>	<b>3,570</b>	<b>4,820</b>	<b>5,210</b>	<b>5,380</b>	<b>3,610</b>	<b>3,875</b>	<b>4,095</b>	<b>4,530</b>
<b>(Model #8)</b>	Closed arm						2¾	42	3,685	3,845	4,000	5,400	5,865	6,045	4,085	4,420	4,680	5,205
<b>(Model #7)</b>	Sled base with cap						2¼	34	<b>4,070</b>	<b>4,280</b>	<b>4,350</b>	<b>5,480</b>	<b>5,840</b>	<b>5,995</b>	<b>4,400</b>	<b>4,670</b>	<b>4,890</b>	<b>5,320</b>

## MEDIUM BACK

 	<b>1412_</b>	18½ - 21½	25	25	26	40½												
<b>(Model #1)</b>	Urethane arm						2	36	3,125	3,270	3,375	4,605	5,005	5,155	3,420	3,660	3,850	4,235
<b>(Model #2)</b>	Urethane arm with cap						2¼	39	<b>3,330</b>	<b>3,495</b>	<b>3,595</b>	<b>4,945</b>	<b>5,375</b>	<b>5,530</b>	<b>3,660</b>	<b>3,930</b>	<b>4,150</b>	<b>4,580</b>
<b>(Model #3)</b>	Urethane arm with cap & wrap						2½	41	3,435	3,595	3,730	5,125	5,575	5,735	3,805	4,105	4,345	4,820
<b>(Model #8)</b>	Closed arm						3	46	<b>3,800</b>	<b>3,985</b>	<b>4,160</b>	<b>5,695</b>	<b>6,185</b>	<b>6,390</b>	<b>4,240</b>	<b>4,595</b>	<b>4,885</b>	<b>5,460</b>

## HIGH BACK

 	<b>1413_</b>	18½ - 21½	25	25	26	45												
<b>(Model #1)</b>	Urethane arm						2¼	38	3,730	3,920	4,000	5,295	5,710	5,875	4,060	4,330	4,550	4,980
<b>(Model #2)</b>	Urethane arm with cap						2½	41	<b>3,960</b>	<b>4,165</b>	<b>4,275</b>	<b>5,645</b>	<b>6,105</b>	<b>6,295</b>	<b>4,330</b>	<b>4,630</b>	<b>4,870</b>	<b>5,345</b>
<b>(Model #3)</b>	Urethane arm with cap & wrap						2¾	43	4,050	4,245	4,370	5,815	6,295	6,475	4,455	4,785	5,050	5,575
<b>(Model #8)</b>	Closed arm						3	48	<b>4,425</b>	<b>4,615</b>	<b>4,790</b>	<b>6,390</b>	<b>6,920</b>	<b>7,130</b>	<b>4,865</b>	<b>5,220</b>	<b>5,510</b>	<b>6,085</b>

Senator Executive series is available as CAL 133 certified for an upcharge of \$390 list per chair. Certification applies to Nienkämper leathers and fabrics that have a minimum of 50% natural fibre content. COM's and COL's are subject to approval. Add the extension "-CAL" to the model number when ordering.

Specify model number for arm selection.

### Standard Features:

- Pneumatic height adjustment
- Back tilt locking mechanism
- Tension control
- Carpet casters
- Black five-star base

### Optional Features:

- Hard floor casters, Black, add \$85 list per chair
- Glides, add \$105 list per chair
- Polished aluminum five-star base with chrome casters, add \$205 list
- Chrome finish sled base, add \$190 list

### Upholstery Details:

- Leather upholstery has channel stitching.
- Fabric upholstery is available with channel stitch finished with a French seam detail.

Model # 14122  
Medium Back



Model # 1  
Urethane Arm



Model # 2  
Urethane arm  
with Cap



Model # 3  
Urethane Arm with  
Cap and Wrap



Model # 8  
Closed Arm



# OFFICE SEATING

Senator Mesh Back Chair Designer – Nienkämper

– CND Only –  
Knoll Textiles

Model Number	Seat H"	Arm H"	W"	D"	H"	Fabric Yds.	Leather Sq. Ft.	COM	COL	Neather	Verde	Grano	Cremoso	1	2	3	4
--------------	---------	--------	----	----	----	-------------	-----------------	-----	-----	---------	-------	-------	---------	---	---	---	---

## SENATOR MESH BACK CHAIR - ADJUSTABLE ARMS



<b>14301</b>	<b>Gray arms, back frame and base</b>							<b>Upholstered seat</b>										
	17½	21½	23½	23½	24	36¼-40¼	¼	14	1,185	1,240	1,270	1,625	1,705	1,740	1,295	1,385	1,455	1,605
<b>14302</b>	<b>Gray arms, back frame and base</b>							<b>Mesh seat</b>										
	17½	21½	23½	23½	24	36¼-40¼			1,185									
<b>14305</b>	<b>Black arms, back frame and base</b>							<b>Upholstered seat</b>										
	17½	21½	23½	23½	24	36¼-40¼	¼	14	1,120	1,165	1,195	1,560	1,635	1,670	1,230	1,320	1,395	1,540
<b>14306</b>	<b>Black arms, back frame and base</b>							<b>Mesh seat</b>										
	17½	21½	23½	23½	24	36¼-40¼			1,120									

### Standard Features:

- Mesh back, fabric seat & headrest is standard in black
- Mesh back with lumbar support, lumbar support has 2" adjustment
- Adjustment arms with 3" height adjustment and 1¾" depth adjustment
- Pneumatic height adjustment
- Black or grey five star base is standard, add \$205 list for polished aluminum base with chrome casters

Model # 14301



Model # 14301



# OFFICE SEATING

Slim Chair Designer – Nienkämper

– CND Only –

Model Number	Seat H"	Arm H"	W"	D"	H"	Fabric Yds.	Leather Sq. Ft.	COM	COL	Neather	Verde	Grano	Cremoso	Knoll Textiles			
														1	2	3	4

## SLIM HIGH BACK - ARMLESS



10761	19-22		19	25	45	1¼	30	1,465	1,545	1,655	2,470	2,635	2,720	1,715	1,910	2,070	2,385
-------	-------	--	----	----	----	----	----	-------	-------	-------	-------	-------	-------	-------	-------	-------	-------

## SLIM HIGH BACK - FIXED ARM



10762	19-22	26-29	25½	25	45	1¼	30	1,765	1,850	1,945	2,770	2,950	3,030	2,015	2,205	2,370	2,685
-------	-------	-------	-----	----	----	----	----	-------	-------	-------	-------	-------	-------	-------	-------	-------	-------

## SLIM HIGH BACK - CANTILEVER ARM



10763	19-22	26-29	25½	25	45	1¼	30	1,730	1,805	1,885	2,540	2,700	2,775	1,975	2,170	2,335	2,650
-------	-------	-------	-----	----	----	----	----	-------	-------	-------	-------	-------	-------	-------	-------	-------	-------

### Standard Features:

- Molded plywood seat shell
- Soy based flexible polyurethane foam
- Fixed arm model has polished aluminum arm supports and black soft textured arm cap
- Cantilever arm model has polished sides with black textured arm cap
- Pneumatic height adjustment
- Back tilt locking mechanism
- Carpet casters
- Black five-star base & casters

### Optional Features:

- Hard floor casters, Black, add \$85 list per chair
- Glides, add \$105 list per chair
- Polished aluminum five-star base with chrome casters, add \$205 list

Model # 10761



Model # 10762



Model # 10763



Slim high back with cantilever arms with polished sides and black textured arm cap

# OFFICE SEATING

Trench - Upholstered Arms Designer – Favaretto & Partners

– CND Only –

Model Number	Seat H"	Arm H"	W"	D"	H"	Fabric Yds.	Leather Sq. Ft.	COM	COL	Neather Verde	Grano Cremoso	KnollTextiles			
												1	2	3	4

## TRENCH LOW BACK - UPHOLSTERED ARMS



<b>10371</b>	18-21	27-30	25½	26	35½-38½	2½	45	2,610	2,745	2,860	4,000	4,240	4,355	2,980	3,280	3,520	4,000
--------------	-------	-------	-----	----	---------	----	----	-------	-------	-------	-------	-------	-------	-------	-------	-------	-------

Extra sq. ft. COL for pleats detail on inside back: 5

## TRENCH MEDIUM BACK - UPHOLSTERED ARMS



<b>10372</b>	18-21	27-30	25½	26	40½-43½	3	54	2,730	2,865	3,030	4,370	4,665	4,800	3,175	3,530	3,820	4,395
--------------	-------	-------	-----	----	---------	---	----	-------	-------	-------	-------	-------	-------	-------	-------	-------	-------

Extra sq. ft. COL for pleats detail on inside back: 5

## TRENCH HIGH BACK WITH HEADREST - UPHOLSTERED ARMS



<b>10373</b>	18-21	27-30	25½	26	48½-51½	3-½	63	3,100	3,265	3,450	5,015	5,350	5,515	3,615	4,035	4,370	5,035
--------------	-------	-------	-----	----	---------	-----	----	-------	-------	-------	-------	-------	-------	-------	-------	-------	-------

Extra sq. ft. COL for pleats detail on inside back: 5

### Standard Features:

- Seat depth : 20"D, Headrest : 8"H
- Steel frame with polyurethane foam
- Distinctive pleats on the convex inside back for both leather & fabric upholstery is standard in Verde leather
- Extra 5 sqft. COL is required for pleat detail
- Upholstered arms and adjustable arms are both available
- Pneumatic height adjustment
- Synchronized seat and back recline
- Black five star base and 3" dia. carpet casters are standard
- Add \$205 list for mirror polished base with chrome casters

Model # 10372



Trench medium back chair upholstered in Ecopell leather, color Caramel EC363 with Ecopell leather, color Milkshake EC737 pleats detail on inside back

# nienkämper

## SEATING & MEETING PODS

### SIDE CHAIRS



**2026**

## **SIDE CHAIRS**

### **TABLE OF CONTENTS**

---

<b>Side Chairs</b>	<b>24-28</b>
HSC	26
Kush	27
Senator® Nuvo Sled Base	28

# SIDE CHAIRS

HSC Designer - HUB Design Studio

Model Number	Seat H"	W"	D"	H"	Fabric Yds.	Leather Sq. Ft.	- CND Only - Knoll Textiles							
							COM	COL	Neather	Verde	Grano	Cremoso	1	2

## HSC CHAIR ON WOOD LEGS



<b>38801</b>	17	25¾	24	31	2½	45	2,645	2,780	2,900	4,040	4,275	4,390	3,010	3,310	3,550	4,030
--------------	----	-----	----	----	----	----	-------	-------	-------	-------	-------	-------	-------	-------	-------	-------

## HSC CHAIR ON STEEL LEGS



<b>38802</b>	17	25¾	24	31	2½	45	2,115	2,220	2,360	3,465	3,705	3,825	2,480	2,780	3,020	3,500
--------------	----	-----	----	----	----	----	-------	-------	-------	-------	-------	-------	-------	-------	-------	-------

**Standard Features:**

- Seat depth: 18"; Seat width: 20 ½"
- Molded foam frame with flexible foam on seat and back.
- Wood legs available in 3 species: solid yellow birch, maple or walnut and finished natural or stained with any Nienkämper standard color.
- Steel legs available in silver, black or warm white powder coat finish.

**Model #38801**



**Model #38802**



# SIDE CHAIRS

Kush Designer - MSDS Studio

— CND Only —

Model Number	Seat H"	Arm H"	W"	D"	H"	Fabric Yds.	Leather Sq. Ft.	COM	COL	Neather	Verde	Grano	Cremoso	Knoll Textiles			
														1	2	3	4

## KUSH

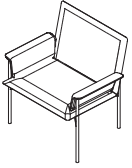

10360	19½	25½	28	25	34	3	54	2,940	3,080	3,230	3,300	4,870	5,020	3,385	3,740	4,030	4,605
-------	-----	-----	----	----	----	---	----	-------	-------	-------	-------	-------	-------	-------	-------	-------	-------

**Standard Features:**

- Frame is constructed from plywood core
- Seat & back cushions have a foam core with Dacron wrap
- Upholstered arm support with polyurethane foam
- Legs are standard in black powder coat finish

**Model # 10360**

Kush chair upholstered in Ecopell leather, color Caramel EC 363.



# OFFICE SEATING

Senator® Nuvo Designer – Nienkämper

– CND Only –

Model Number	Seat H"	Arm H"	W"	D"	H"	Fabric Yds.	Leather Sq. Ft.	COM	COL	Verde	Grano	Cre-moso	Knoll Textiles			
													1	2	3	4

## ARMCHAIR SLED BASE



**14103** 17½ 24½ 23 25 31 1¼ 32

2,360 2,475 3,035 3,320 3,390 2,615 2,825 2,995 3,330

### Standard Features

- Chrome tubular sled base
- Plain upholstery

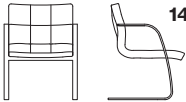

**14104** 17½ 24½ 23 25 31 1¼ 32

3,630 3,815 4,300 4,585 4,680 3,885 4,095 4,265 4,600

### Standard Features

- Solid flat chrome sled base
- Tufted upholstery

## ARMCHAIR CASTER BASE



**14107** 17½ 24½ 23 25 31 1¼ 32

2,585 2,715 3,245 3,475 3,530 2,845 3,055 3,220 3,555

### Standard Features:

- Chrome or black base
- Chrome or black casters
- Plain upholstery

**Model # 14103**  
Senator® Nuvo Armchair  
with tubular chrome sled base



**Model # 14105**  
Senator® Nuvo Armchair  
with flat chrome sled base



**Model # 14107**  
Senator® Nuvo Armchair Caster Base



# nienkämpfer

## SEATING & MEETING PODS

LOUNGE FURNITURE



2026

**LOUNGE SEATING**  
**TABLE OF CONTENTS**

---

**Lounge Seating**

**29-83**

Bare	31	Kloud® Serpentine™	60
BASS Collection	32-33	Leaf	61
Bay	34	Nordic	62
Beam Lounge	35-36	Note	63
Berkley® Collection	37-42	Radius	64-65
Blob	43	Rowan Lounge	66
Carlisle	44	Satori™	67
Dobi	45	Six® Collection	68
Dune	46	Turnaround®	69
Elite	47	Tuxedo™	70-71
Gateway Lounge	48-53		
Godbout	54	Tuxedo™ Classic	72-75
Heartbeat	55-56	Tuxedo™ Cove	73-79
Isola 8	57	Tuxedo™ High Back	80-81
J + J Studio	58	Wavelength®	82-83
Kloud® Collection	59		

# LOUNGE SEATING

Bare Designer - Evan Bare

— CND Only —

Model Number	Seat Arm			D"	H"	Fabric Yds.	Leather Sq. Ft.	COM	COL	Neather	Verde	Grano	Cremoso	Knoll Textiles			
	H"	H"	W"											1	2	3	4

## BARE CHAIR



<b>10321</b>	16¾	26	33	29 ½	3¾	68											
						Seat	1¼	23									
						Back	2 ½	45									

5,100	5,370	5,510	7,380	7,750	7,950	5,650	6,100	6,460	7,180
-------	-------	-------	-------	-------	-------	-------	-------	-------	-------

## BARE TWO SEAT SOFA

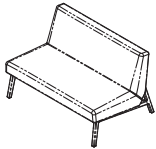

<b>10322</b>	16¾	50	33	29 ½	5¾	104											
						Seat	2¼	41									
						Back	3 ½	63									

6,875	7,220	7,630	10,300	10,885	11,175	7,720	8,400	8,960	10,060
-------	-------	-------	--------	--------	--------	-------	-------	-------	--------

Model # 10321  
Bare Chair



Model # 10322  
Bare Two Seat Sofa



### Standard Features:

- Seat depth: 21"d
- Plywood frame with soy based polyurethane foam.
- Solid maple or walnut legs are standard in ebonized finish but also available in any Nienkämper stains.
- Custom stain is available with upcharge.

# LOUNGE SEATING

BASS Collection Designer - Busk + Hertzog

— CND Only —

KnollTextiles

Model Number	Seat H"	Arm H"	W"	D"	H"	Fabric Yds.	Leather Sq. Ft.	COM	COL	Verde	Grano	Cremoso	1	2	3	4
--------------	---------	--------	----	----	----	-------------	-----------------	-----	-----	-------	-------	---------	---	---	---	---

## BASS LOW BACK SMALL LOUNGE CHAIR

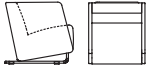

<b>12011</b>	17	26½	27	29	26½	5	90									
			seat & back			3	54									
			arms			3½	63									

3,630	3,820	6,565	7,170	7,475	4,365	4,960	5,440	6,395
-------	-------	-------	-------	-------	-------	-------	-------	-------

## BASS LOW BACK LARGE LOUNGE CHAIR

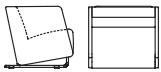

<b>12012</b>	17	26½	32	29	26½	6½	99									
			seat & back			3	54									
			arms			3½	63									

3,760	3,960	6,965	7,630	7,950	4,715	5,490	6,120	7,365
-------	-------	-------	-------	-------	-------	-------	-------	-------

## BASS LOW BACK 2 SEATER SOFA

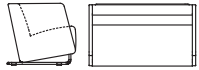

<b>12013</b>	17	26½	59	29	26½	7½	135									
			seat & back			5	90									
			arms			3½	63									

5,035	5,290	8,670	9,420	9,800	6,140	7,030	7,755	9,190
-------	-------	-------	-------	-------	-------	-------	-------	-------

## BASS LOW BACK 3 SEATER SOFA

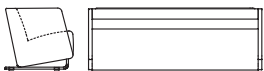

<b>12014</b>	17	26½	82	29	26½	9½	171									
			seat & back			7	126									
			arms			3½	63									

6,990	7,350	11,085	11,910	12,320	8,385	9,515	10,435	12,250
-------	-------	--------	--------	--------	-------	-------	--------	--------

### Standard Features:

- Frame is constructed of hardwood, plywood and soy-based polyurethane foam.
- Polished chrome tubular base

Model # 12011

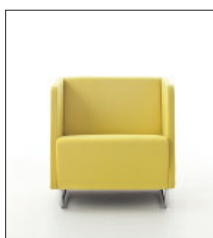

Model # 12013



Model # 12014



# LOUNGE SEATING

BASS Collection Designer - Busk + Hertzog

– CND Only –

Model Number	Seat H"	Arm H"	W"	D"	H"	Fabric		COM	COL	Verde	Grano	Cremoso	Knoll Textiles			
						Yds.	Sq. Ft.						1	2	3	4

## BASS HIGH BACK LARGE LOUNGE CHAIR

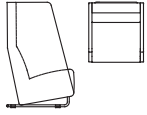

<b>12024</b>	17	46½	32	29	46½	7	126	5,185	5,455	8,945	9,720	10,110	6,215	7,050	7,720	9,060
		seat & back					4½	81								
		arms					5⅓	96								

## BASS HIGH BACK 2 SEATER SOFA

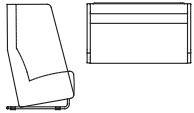

<b>12022</b>	17	46½	59	29	46½	11	198	6,545	6,875	12,365	13,595	14,195	8,160	9,470	10,530	12,635
		seat & back					6¾	122								
		arms					5⅓	96								

## BASS HIGH BACK 3 SEATER SOFA

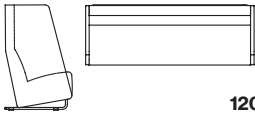

<b>12023</b>	17	46½	82	29	46½	13	234	8,595	9,030	15,525	16,955	17,680	10,510	12,050	13,305	15,795
		seat & back					9	162								
		arms					5⅓	96								

Model # 12022



Model # 12023



### Standard Features:

- Frame is constructed of hardwood, plywood and soy-based polyurethane foam.
- Polished chrome tubular base



# LOUNGE SEATING

Bay Designer - Busk + Hertzog

– CND Only –

Model Number	Seat H"	W"	D"	H"	Fabric		COM	COL	Neather	Verde	Grano	Cremoso	Knoll Textiles			
					Yds.	Sq. Ft.							1	2	3	4

## BAY CHAIR WITH UPHOLSTERED BASE

	<b>10520</b>	16	26	27¾	26¼	3¼	59														
	Fully upholstered																				
	<b>10521</b>	Contrasting Fabric							2,915	3,070	3,280	4,830	5,185	5,370	3,395	3,780	4,095	4,715			
		Seat																			
		Base																			
	<b>10522</b>	Contrasting Leather																			
		Seat																			
		Base																			
	<b>10523</b>	16½	26	27¾	26¼	3¼	59														
	Fully upholstered w/ swivel																				
	<b>10524</b>	Contrasting Fabric w/ Swivel							3,475	3,625	3,835	5,390	5,740	5,925	3,950	4,340	4,655	5,275			
		Seat																			
		Base																			
	<b>10525</b>	Contrasting Leather w/ Swivel																			
		Seat																			
		Base																			

### Standard Features:

- Seat with plywood shell and soy based flexible polyurethane foam
- Base in rigid polyurethane
- Base with plastic glides on bottom
- Standard swivel mechanism rotates 360° and is weight rated for 400lbs
- Swivel base disk constructed of ¼" steel and powder coated black
- Add \$165 list to price of swivel base if a memory return swivel is desired

### Model # 10521



# LOUNGE SEATING

Beam Collection - Designer - Kenny Nguyen

— CND Only —

Model Number	Seat H"	W"	D"	H"	Yds.	Sq. Ft.	COM	COL	Neather	Verde	Grano	Cremoso	KnollTextiles			
													1	2	3	4

## BEAM OTTOMAN



14929	16 3/4	28	31	16 3/4	4	72								2,835	2,980	3,160	5,000	5,345	5,700	3,425	3,905	4,285	5,055
-------	--------	----	----	--------	---	----	--	--	--	--	--	--	--	-------	-------	-------	-------	-------	-------	-------	-------	-------	-------

## BEAM LOUNGE CHAIR



14931	16 3/4	28 5/8	39 3/4	31	4.5	100								3,690	3,875	4,140	6,745	7,185	7,735	4,350	4,885	5,320	6,180
-------	--------	--------	--------	----	-----	-----	--	--	--	--	--	--	--	-------	-------	-------	-------	-------	-------	-------	-------	-------	-------

## BEAM 2 SEAT



14932	16 3/4	58 5/8	39 3/4	31	9	200								7,370	7,740	8,270	13,475	14,355	15,460	8,690	9,760	10,630	12,350
-------	--------	--------	--------	----	---	-----	--	--	--	--	--	--	--	-------	-------	-------	--------	--------	--------	-------	-------	--------	--------

## BEAM 3 SEAT



14933	16 3/4	88 5/8	39 3/4	31	13.5	300								11,055	11,610	12,410	20,210	21,535	23,185	13,040	14,645	15,945	18,525
-------	--------	--------	--------	----	------	-----	--	--	--	--	--	--	--	--------	--------	--------	--------	--------	--------	--------	--------	--------	--------

### Standard Features:

- Constructed from high resilient foam molded over wood frame
- Structural wood beam available in all standard Veneer, stains and finishes



### Model # 14931

Beam Lounge Chair Back upholstered in Maharam Nico, 022 Jousting Seat upholstered in Maharam Nico, 021 Rosin



# LOUNGE SEATING

Beam Collection - Designer - Kenny Nguyen

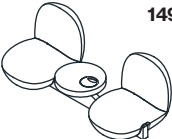
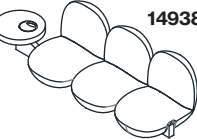
Model Number	Seat H"	W"	D"	H"	Fabric Yds.	Leather Sq. Ft.	COM	COL	Neather	Verde	Grano	Cremoso	- CND Only - Knoll Textiles				
													1	2	3	4	
<b>BEAM CHAIR WITH TABLE</b>																	
	14935	16¾"	54"	39¾"	31"	4.5	100	6,100	6,405	6,550	9,275	9,715	10,265	6,760	7,295	7,730	8,590
<b>BEAM 2 SEAT WITH END TABLE</b>																	
	14936	16¾"	84½"	39¾"	31"	9	200	9,780	10,270	10,680	16,005	16,885	17,990	11,100	12,170	13,040	14,760
<b>BEAM 2 SEAT WITH MID TABLE</b>																	
	14937	16¾"	84"	39¾"	31"	9	200	9,780	10,270	10,680	16,005	16,885	17,990	11,100	12,170	13,040	14,760
<b>BEAM 3 SEAT WITH END TABLE</b>																	
	14938	16¾"	114¾"	39¾"	31"	13.5	300	13,465	14,140	14,820	22,740	24,065	25,715	15,450	17,055	18,355	20,935

**Model # 14937**  
Beam Lounge Chair Upholstered in Maharam Nico, 022 Jousting Rift cut, creamy walnut veneer table and beam finish

Table courtesy power with cover

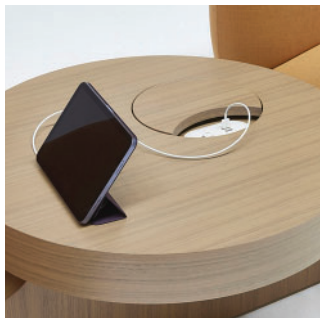

**Standard Features:**

- Constructed from high resilient foam molded over wood frame
- Structural wood beam available in all standard Veneer, stain and finish
- Tables are standard with a courtesy 1 power & dual USB A+C Charger in white finish.

# LOUNGE SEATING

The Berkley® Collection Designer - Nienkämper

– CND Only –

Model Number	Seat H"	W"	D"	H"	Fabric Yds.	Leather Sq. Ft.	COM	COL	Neather	Verde	Grano	Cremoso	Knoll Textiles							
													1	2	3	4				
<b>SINGLE ELEMENT</b>																				
	<b>13410_</b>	16	24	35	27 ½															
	/1	Armless with metal legs			3 ¾	60	<b>3,475</b>	<b>3,730</b>	<b>3,740</b>	<b>4,985</b>	<b>5,395</b>	<b>5,560</b>	<b>4,025</b>	<b>4,470</b>	<b>4,830</b>	<b>5,550</b>				
	/2	8 Angled arm			5 ½	88	4,460	4,785	5,030	7,655	8,505	8,855	5,270	5,925	6,455	7,505				
	/3	10 Angled arm			6 ¼	100	<b>4,590</b>	<b>4,930</b>	<b>5,180</b>	<b>7,830</b>	<b>8,655</b>	<b>8,995</b>	<b>5,510</b>	<b>6,255</b>	<b>6,860</b>	<b>8,050</b>				
	/4	8 Straight arm with leg			5 ½	88	5,975	6,415	6,470	8,665	9,395	9,670	6,785	7,440	7,970	9,020				
	/5	10 Straight arm with leg			6 ¼	100	<b>6,040</b>	<b>6,475</b>	<b>6,535</b>	<b>8,735</b>	<b>9,445</b>	<b>9,730</b>	<b>6,960</b>	<b>7,705</b>	<b>8,310</b>	<b>9,500</b>				

Note: Width measurements do not include arms.

## TWO SEAT ELEMENT

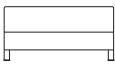
	<b>13401_</b>	16	48	35	27 ½															
	/1	Armless with metal legs			3 ¾	60	<b>4,495</b>	<b>4,830</b>	<b>4,965</b>	<b>7,035</b>	<b>7,700</b>	<b>7,960</b>	<b>5,050</b>	<b>5,495</b>	<b>5,855</b>	<b>6,575</b>				
	/2	8 Angled arm			5 ½	88	5,480	5,890	6,240	9,700	10,805	11,265	6,285	6,945	7,475	8,525				
	/3	10 Angled arm			6 ¼	100	<b>5,625</b>	<b>6,050</b>	<b>6,390</b>	<b>9,865</b>	<b>10,975</b>	<b>11,425</b>	<b>6,545</b>	<b>7,290</b>	<b>7,895</b>	<b>9,085</b>				
	/4	8 Straight arm with leg			5 ½	88	6,995	7,510	7,665	10,720	11,710	12,100	7,805	8,460	8,990	10,040				
	/5	10 Straight arm with leg			6 ¼	100	<b>7,055</b>	<b>7,600</b>	<b>7,730</b>	<b>10,790</b>	<b>11,760</b>	<b>12,155</b>	<b>7,970</b>	<b>8,715</b>	<b>9,320</b>	<b>10,515</b>				

Note: Width measurements do not include arms.

## LARGE TWO SEAT ELEMENT

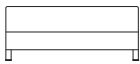
	<b>13402_</b>	16	60	35	27 ½															
	/1	Armless with metal legs			4 ¼	68	<b>4,800</b>	<b>5,160</b>	<b>5,325</b>	<b>7,665</b>	<b>8,440</b>	<b>8,735</b>	<b>5,425</b>	<b>5,935</b>	<b>6,345</b>	<b>7,155</b>				
	/2	8 Angled arm			6	96	5,790	6,210	6,610	10,350	11,545	12,020	6,670	7,385	7,960	9,110				
	/3	10 Angled arm			6 ¾	108	<b>5,930</b>	<b>6,380</b>	<b>6,760</b>	<b>10,510</b>	<b>11,710</b>	<b>12,180</b>	<b>6,920</b>	<b>7,725</b>	<b>8,375</b>	<b>9,670</b>				
	/4	8 Straight arm with leg			6	96	7,300	7,850	8,065	11,370	12,435	12,840	8,180	8,895	9,475	10,625				
	/5	10 Straight arm with leg			6 ¾	108	<b>7,375</b>	<b>7,920</b>	<b>8,105</b>	<b>11,430</b>	<b>12,485</b>	<b>12,935</b>	<b>8,365</b>	<b>9,170</b>	<b>9,820</b>	<b>11,110</b>				

Note: Width measurements do not include arms.

Berkley Collection passes CAL 133 certified for an upcharge of \$435 list per single element, \$870 list per 2 seat element, and \$1,095 list per large 2 seat element. Certification applies to Nienkämper leathers and fabrics that have a minimum of 50% natural fibre content. COM's and COL's are subject to approval. Add the extension -CAL to the model number when ordering.

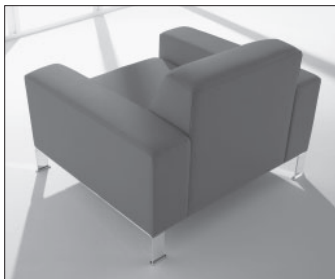

Model # 1  
Armless



Model # 2  
8 Angled Arm



Model # 3  
10 Angled Arm



Model # 4  
8 Angled Arm



Model # 5  
10 Angled Arm



# LOUNGE SEATING

The Berkley® Collection Designer - Nienkämper

— CND Only —

Model Number	Seat H"	W"	D"	H"	Fabric Yds.	Leather Sq. Ft.	COM	COL	Neather	Verde	Grano	Cremoso	Knoll Textiles			
													1	2	3	4

## FOUR SEAT ELEMENT

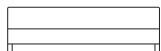
Model	Seat H"	W"	D"	H"	Fabric Yds.	Leather Sq. Ft.	COM	COL	Neather	Verde	Grano	Cremoso	1	2	3	4						
 13405_	16	96	35	27½																		
/1	Armless with metal legs				6¼	100							6,415	6,885	7,180	10,640	11,755	12,210	7,330	8,075	8,680	9,870
/2	8 Angled arm				8	128							7,390	7,930	8,450	13,295	14,880	15,490	8,565	9,515	10,285	11,820
/3	10 Angled arm				8 ¾	140							7,570	8,100	8,610	13,465	15,025	15,625	8,855	9,895	10,740	12,415
/4	8 Straight arm with leg				8	128							8,900	9,570	9,900	14,320	15,760	16,315	10,075	11,025	11,800	13,330
/5	10 Straight arm with leg				8 ¾	140							8,970	9,640	9,960	14,395	15,825	16,375	10,255	11,295	12,140	13,815

Note: Width measurements do not include arms.

## LARGE FOUR SEAT ELEMENT

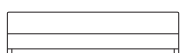
Model	Seat H"	W"	D"	H"	Fabric Yds.	Leather Sq. Ft.	COM	COL	Neather	Verde	Grano	Cremoso	1	2	3	4						
 13418_	16	108	35	27½																		
/1	Armless with metal legs				7	112							7,150	7,660	7,990	11,865	13,115	13,615	8,175	9,010	9,685	11,020
/2	8 Angled arm				8¾	140							8,120	8,730	9,295	14,550	16,255	16,920	9,405	10,445	11,290	12,965
/3	10 Angled arm				9¾	152							8,290	8,880	9,430	14,695	16,390	17,070	9,685	10,800	11,710	13,510
/4	8 Straight arm with leg				8¾	140							9,640	10,350	10,720	15,565	17,110	17,740	10,930	11,965	12,810	14,485
/5	10 Straight arm with leg				9½	152							9,695	10,425	10,785	15,615	17,180	17,800	11,090	12,220	13,140	14,955

Note: Width measurements do not include arms.

Berkley Collection passes CAL 133 certified for an upcharge of \$1,755 list per 4 seat element, and \$1,975 per large 4 seat element. Certification applies to Nienkämper leathers and fabrics that have a minimum of 50% natural fibre content. COM's and COL's are subject to approval. Add the extension -CAL to the model number when ordering.

The Berkley Collection is a Nienkämper classic in its contemporary style and simplicity of line. This is a collection that is elegant yet generous in proportions. Berkley works well in public spaces, executive lounges, lobbies, and residences.

**Frame:**  
Solid maple and plywood construction.

**Seat and Back:**  
The seat and back are polyurethane foam covered in Fortrel®. Upholstered in leather or fabric. Yardages are for plain non-directional fabrics. Fabrics are railroaded.

**Arms:**  
Two arm options are available, Angled and Straight. The Angled arm carries to the floor. The Straight arm rests on an aluminum base.

**Base:**  
On models with Angled arms, the base is solid maple runners painted matte black. Aluminum bases are available in a brushed, polished, or painted finish.

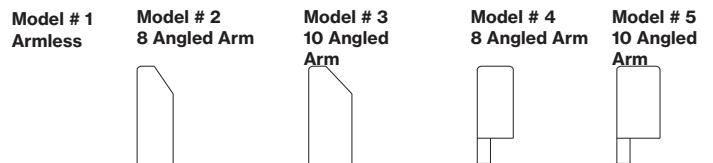

# LOUNGE SEATING



The Berkley® Collection Designer – Nienkämper

– CND Only –

Model Number	Seat H"	W"	D"	H"	Fabric Yds.	Leather Sq. Ft.	COM	COL	Neather	Verde	Grano	Cremoso	Knoll Textiles						
													1	2	3	4			
<b>FIVE SEAT ELEMENT</b>																			
	<b>13419_</b>	16	120	35	27½														
/1 Armless with metal legs					7 ¾	139½	<b>7,870</b>	<b>8,450</b>	<b>8,850</b>	<b>13,115</b>	<b>14,510</b>	<b>15,045</b>	<b>9,010</b>	<b>9,935</b>	<b>10,680</b>	<b>12,160</b>			
/2 8 Angled arm					9 ½	152	8,860	9,520	10,115	15,785	17,615	18,340	10,255	11,385	12,305	14,120			
/3 10 Angled arm					10 ¼	164	<b>9,000</b>	<b>9,680</b>	<b>10,270</b>	<b>15,930</b>	<b>17,780</b>	<b>18,505</b>	<b>10,510</b>	<b>11,725</b>	<b>12,720</b>	<b>14,675</b>			
/4 8 Straight arm with leg					9 ½	152	10,380	11,150	11,550	16,820	18,505	19,170	11,780	12,905	13,825	15,640			
/5 10 Straight arm with leg					10 ¼	164	<b>10,440</b>	<b>11,220</b>	<b>11,615</b>	<b>16,860</b>	<b>18,560</b>	<b>19,240</b>	<b>11,945</b>	<b>13,165</b>	<b>14,155</b>	<b>16,115</b>			

Note: Width measurements do not include arms.

## BENCH

	<b>13411</b>	16	48	24	16	2 ¼	32	<b>2,335</b>	<b>2,485</b>	<b>2,565</b>	<b>3,690</b>	<b>4,015</b>	<b>4,165</b>	<b>2,665</b>	<b>2,930</b>	<b>3,150</b>	<b>3,585</b>		
	<b>13412</b>	16	60	24	16	2 ¾	40	2,385	2,555	2,660	3,915	4,300	4,470	2,790	3,120	3,385	3,910		
	<b>13413</b>	16	72	24	16	3 ¼	48	<b>2,785</b>	<b>2,995</b>	<b>3,090</b>	<b>4,475</b>	<b>4,925</b>	<b>5,090</b>	<b>3,265</b>	<b>3,650</b>	<b>3,965</b>	<b>4,585</b>		
	<b>13414</b>	16	84	24	16	3 ¾	56	3,595	3,870	3,940	5,470	5,940	6,140	4,145	4,590	4,955	5,670		
	<b>13415</b>	16	96	24	16	4 ¼	64	<b>3,805</b>	<b>4,070</b>	<b>4,165</b>	<b>5,825</b>	<b>6,355</b>	<b>6,555</b>	<b>4,430</b>	<b>4,935</b>	<b>5,345</b>	<b>6,155</b>		

Note: Width measurements do not include arms.

Berkley Collection passes CAL 133 certified for an upcharge of \$2,195 list per 5 seat element, \$505 list per 48 bench, \$630 list per 60 bench, \$760 list per 72 bench, \$890 list per 84 bench, and \$1010 list per 96 bench. Certification applies to Nienkämper leathers and fabrics that have a minimum of 50% natural fibre content. COM's and COL's are subject to approval. Add the extension -CAL to the model number when ordering.

The Berkley Collection is a Nienkämper classic in its contemporary style and simplicity of line. This is a collection that is elegant yet generous in proportions. Berkley works well in public spaces, executive lounges, lobbies, and residences.

### Frame:

Solid maple and plywood construction.

### Seat and Back:

The seat and back are polyurethane foam covered in Fortrel®. Upholstered in leather or fabric. Yardages are for plain non-directional fabrics. Fabrics are railroaded.

### Arms:

Two arm options are available, Angled and Straight. The Angled arm carries to the floor. The Straight arm rests on an aluminum base.

### Base:

On models with Angled arms, the base is solid maple runners painted matte black. Aluminum bases are available in a brushed, polished, or painted finish.

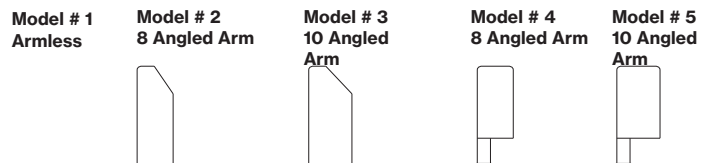

# LOUNGE SEATING

The Berkley® Collection Designer - Nienkämper

— CND Only —

Model Number	Seat H"	W"	D"	H"	Fabric Yds.	Leather Sq. Ft.	COM	COL	Neather	Verde	Grano	Cremoso	Knoll Textiles			
													1	2	3	4

## LEFT CORNER ELEMENTS

<b>One Seat Left Element</b>																
13421_	16	23½-58½	35	27½												
/1	Armless with metal legs				4¼	68	<b>3,915</b>	<b>4,200</b>	<b>4,445</b>	<b>6,775</b>	<b>7,570</b>	<b>7,845</b>	<b>4,540</b>	<b>5,050</b>	<b>5,455</b>	<b>6,265</b>
/2	8 Angled arm				5	80	4,375	4,710	5,060	8,050	8,975	9,360	5,110	5,705	6,185	7,140
/3	10 Angled arm				5½	86	<b>4,470</b>	<b>4,800</b>	<b>5,130</b>	<b>8,100</b>	<b>9,075</b>	<b>9,440</b>	<b>5,280</b>	<b>5,935</b>	<b>6,465</b>	<b>7,515</b>
/4	8 Straight arm with leg				5	80	5,155	5,530	5,775	8,550	9,430	9,780	5,890	6,480	6,965	7,920
/5	10 Straight arm with leg				5½	86	<b>5,185</b>	<b>5,575</b>	<b>5,805</b>	<b>8,570</b>	<b>9,450</b>	<b>9,805</b>	<b>5,995</b>	<b>6,650</b>	<b>7,180</b>	<b>8,230</b>

Note: Width measurements do not include arms. One arm and one element must be specified with each element ordered

<b>Two Seat Left Element</b>																
13422_	16	47¼-82½	35	27½												
/1	Armless with metal legs				5¾	92	<b>4,930</b>	<b>5,305</b>	<b>5,640</b>	<b>8,820</b>	<b>9,865</b>	<b>10,265</b>	<b>5,775</b>	<b>6,460</b>	<b>7,015</b>	<b>8,120</b>
/2	8 Angled arm				6½	104	5,415	5,825	6,270	10,075	11,295	11,785	6,370	7,140	7,770	9,015
/3	10 Angled arm				7	110	<b>5,505</b>	<b>5,920</b>	<b>6,350</b>	<b>10,140</b>	<b>11,375</b>	<b>11,860</b>	<b>6,535</b>	<b>7,370</b>	<b>8,040</b>	<b>9,380</b>
/4	8 Straight arm with leg				6½	104	6,185	6,640	6,985	10,580	11,745	12,210	7,140	7,915	8,545	9,790
/5	10 Straight arm with leg				7	110	<b>6,210</b>	<b>6,690</b>	<b>7,020</b>	<b>10,615</b>	<b>11,760</b>	<b>12,225</b>	<b>7,235</b>	<b>8,070</b>	<b>8,745</b>	<b>10,080</b>

Note: Width measurements do not include arms. One arm and one element must be specified with each element ordered

<b>Three Seat Left Element</b>																
13423_	16	71½-106½	35	27½												
/1	Armless with metal legs				7¼	116	<b>5,635</b>	<b>6,055</b>	<b>6,540</b>	<b>10,540</b>	<b>11,835</b>	<b>12,350</b>	<b>6,700</b>	<b>7,560</b>	<b>8,265</b>	<b>9,650</b>
/2	8 Angled arm				8	128	6,135	6,585	7,160	11,795	13,280	13,885	7,310	8,260	9,030	10,565
/3	10 Angled arm				8½	134	<b>6,205</b>	<b>6,665</b>	<b>7,230</b>	<b>11,865</b>	<b>13,155</b>	<b>13,950</b>	<b>7,450</b>	<b>8,465</b>	<b>9,285</b>	<b>10,905</b>
/4	8 Straight arm with leg				8	128	6,885	7,405	7,870	12,315	13,720	14,295	8,060	9,010	9,785	11,315
/5	10 Straight arm with leg				8½	134	<b>6,925</b>	<b>7,435</b>	<b>7,905</b>	<b>12,335</b>	<b>13,775</b>	<b>14,320</b>	<b>8,175</b>	<b>9,190</b>	<b>10,010</b>	<b>11,630</b>

Note: Width measurements do not include arms. One arm and one element must be specified with each element ordered

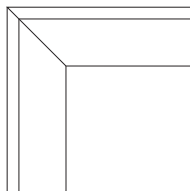
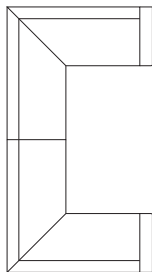

Model # 1  
Armless

Model # 2  
8 Angled Arm

Model # 3  
10 Angled Arm

Model # 4  
8 Angled Arm

Model # 5  
10 Angled Arm



Yardages are for plain non-directional fabrics. Fabrics are railroaded. COM must be approved before placing an order.

# LOUNGE SEATING

The Berkley® Collection Designer – Nienkämper

– CND Only –

Model Number	Seat H"	W"	D"	H"	Fabric Yds.	Leather Sq. Ft.	Knoll Textiles											
							COM	COL	Neather	Verde	Grano	Cremoso	1	2	3	4		

## RIGHT CORNER ELEMENTS



### One Seat Right Element

Model #	Seat H"	W"	D"	H"	Fabric Yds.	Leather Sq. Ft.	COM	COL	Neather	Verde	Grano	Cremoso	1	2	3	4	
13424_	16	23½-58½	35	27 ½													
/1	Armless with metal legs				4 ¼	68	3,915	4,200	4,445	6,775	7,570	7,845	4,540	5,050	5,455	6,265	
/2	8 Angled arm				5	80	4,375	4,710	5,060	8,050	8,975	9,360	5,110	5,705	6,185	7,140	
/3	10 Angled arm				5 ½	86	4,470	4,800	5,130	8,100	9,075	9,440	5,280	5,935	6,465	7,515	
/4	8 Straight arm with leg				5	80	5,155	5,530	5,775	8,550	9,430	9,780	5,890	6,480	6,965	7,920	
/5	10 Straight arm with leg				5 ½	86	5,185	5,575	5,805	8,570	9,450	9,805	5,995	6,650	7,180	8,230	



### Two Seat Right Element

Model #	Seat H"	W"	D"	H"	Fabric Yds.	Leather Sq. Ft.	COM	COL	Neather	Verde	Grano	Cremoso	1	2	3	4	
13425_	16	47½-82½	35	27 ½													
/1	Armless with metal legs				5 ¾	92	4,930	5,305	5,640	8,820	9,865	10,265	5,775	6,460	7,015	8,120	
/2	8 Angled arm				6 ½	104	5,415	5,825	6,270	10,075	11,295	11,785	6,370	7,140	7,770	9,015	
/3	10 Angled arm				7	110	5,505	5,920	6,350	10,140	11,375	11,860	6,535	7,370	8,040	9,380	
/4	8 Straight arm with leg				6 ½	104	6,185	6,640	6,985	10,580	11,745	12,210	7,140	7,915	8,545	9,790	
/5	10 Straight arm with leg				7	110	6,210	6,690	7,020	10,615	11,760	12,225	7,235	8,070	8,745	10,080	

Note: Width measurements do not include arms. One arm and one element must be specified with each element ordered



### Three Seat Right Element

Model #	Seat H"	W"	D"	H"	Fabric Yds.	Leather Sq. Ft.	COM	COL	Neather	Verde	Grano	Cremoso	1	2	3	4	
13426_	16	71½-106½	35	27 ½													
/1	Armless with metal legs				7 ¼	116	5,635	6,055	6,540	10,540	11,835	12,350	6,700	7,560	8,265	9,650	
/2	8 Angled arm				8	128	6,135	6,585	7,160	11,795	13,280	13,885	7,310	8,260	9,030	10,565	
/3	10 Angled arm				8 ½	134	6,205	6,665	7,230	11,865	13,155	13,950	7,450	8,465	9,285	10,905	
/4	8 Straight arm with leg				8	128	6,885	7,405	7,870	12,315	13,720	14,295	8,060	9,010	9,785	11,315	
/5	10 Straight arm with leg				8 ½	134	6,925	7,435	7,905	12,335	13,775	14,320	8,175	9,190	10,010	11,630	

Note: Width measurements do not include arms. One arm and one element must be specified with each element ordered



### Bench w/8 Arm

Model #	Seat H"	W"	D"	H"	Fabric Yds.	Leather Sq. Ft.	COM	COL	Neather	Verde	Grano	Cremoso	1	2	3	4
13416		48	32	21 ½	4	72	5,050	5,295	5,470	7,380	8,145	8,395	5,635	6,115	6,495	7,265

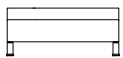

### Bench w/10 Arm

Model #	Seat H"	W"	D"	H"	Fabric Yds.	Leather Sq. Ft.	COM	COL	Neather	Verde	Grano	Cremoso	1	2	3	4
13417		48	34	21 ½	4	72	5,125	5,375	5,530	7,440	8,220	8,480	5,715	6,190	6,575	7,340



### Movable Cushion

Model #	Seat H"	W"	D"	H"	Fabric Yds.	Leather Sq. Ft.	COM	COL	Neather	Verde	Grano	Cremoso	1	2	3	4
13430		24	12	12	1	18	995	1,010	1,125	1,590	1,785	1,840	1,140	1,260	1,355	1,550

Model # 1  
Armless



Model # 2  
8 Angled Arm



Model # 3  
10 Angled Arm





Model # 4  
8 Angled Arm



Model # 5  
10 Angled Arm

# LOUNGE SEATING

Blob™ Designer - Karim Rashid

Model Seat Number H"	W"	D"	H"	Fabric	Leather Yds. Sq. Ft.	COM	COL	Verde	Grano	Cremoso	- CND Only - Knoll Textiles							
											1	2	3	4				
<b>BLOB</b>																		
	1490_ 16	26	32½	29														
	(Model #1) Fully Upholstered				2¾	50	2,310	2,415	3,955	4,375	4,570	2,715	3,045	3,310	3,835			
	(Model #4) Contrasting fabric			sides seat/back	1½	1½	2,310					2,715	3,045	3,310	3,835			
	(Model #5) Contrasting leather		sides seat/back		27	27		2,415	3,955	4,375	4,570							
<b>BLOB TWO SEAT SOFA</b>																		
	16	52	32 ½	29														
	14908 Fully Upholstered				4¾	86	4,125	4,340	6,415	7,010	7,255	4,820	5,390	5,845	6,755			
	14909 Contrasting fabric			sides seat/back	1½	3¾	4,125					4,820	5,390	5,845	6,755			
	14910 Contrasting leather		sides seat/back		27	59		4,340	6,415	7,010	7,255							
<b>BLOB THREE SEAT SOFA</b>																		
	16	78	32 ½	29														
	14921 Fully Upholstered				6½	117	5,745	6,040	8,890	9,720	10,035	6,740	7,540	8,190	9,485			
	14922 Contrasting fabric			sides seat/back	1½	5	5,745					6,740	7,540	8,190	9,485			
	14923 Contrasting leather		sides seat/back		27	90		6,040	8,890	9,720	10,035							

The curvaceous shape and soft molded foam of the Blob is conducive to fabrics with some stretch and minimum pattern.

When upholstered in two different fabrics or leathers, use the COM price and ship your fabric yardage or leather square footage to Nienkämper. See page 7 for COM and COL details.

Seams can have matching or contrasting stitching. Matching or contrasting welting detail can also be specified.

\*For patterned or directional fabrics please contact Customer Service at 800.668.9318 for yardages.

Fabric to be upholstered on Blob requires approval from Nienkämper's factory. Please contact customer service at 800 668 9318 for our fabric approval list.

Model #14904  
Contrasting fabric







Model #14904  
Contrasting fabric



# LOUNGE SEATING

Carlisle Designer - George Yabu & Glenn Pushelburg

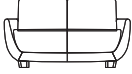
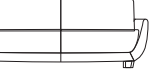
— CND Only —

Model Number	Seat H"	Arm H"	W"	D"	H"	Fabric Leather		Knoll Textiles											
						Yds.	Sq. Ft.	COM	COL	Neather	Verde	Grano	Cremoso	1	2	3	4		
<b>CHAIR WITH SWIVEL DISK</b>																			
	<b>16200</b>	16 ½	22	33	29	29													
	COM cushions & frame		1¾ yds		¾ yds														
	Fully upholstered						4 ½	75	3,800	3,985	4,340	6,885	7,690	8,040	4,460	4,995	5,430	6,290	
	COM seat & back cushions, leather frame						1¾	53		3,985		5,980	6,550	6,775					
<b>CHAIR WITH SWIVEL PEDESTAL BASE</b>																			
	<b>16240</b>	19	24 ½	33	29	32													
	COM cushions & frame		1¾ yds		¾ yds														
	Fully upholstered						4 ½	75	4,160	4,360	4,660	7,025	7,820	8,105	4,820	5,355	5,795	6,655	
	COM seat & back cushions, leather frame						1¾	53		4,360		6,020	6,505	6,700					
<b>CHAIR WITH LEGS</b>																			
	<b>16210</b>	16 ½	22	33	29	29													
	COM cushions & frame		1¾ yds		¾ yds														
	Fully upholstered						4	70	3,985	4,280	6,665	7,435	7,715	4,260	4,385	4,865	5,245	6,015	
	COM seat & back cushions, leather frame						1¾	45	3,985		5,645	6,135	6,325						
<b>TWO SEAT SOFA</b>																			
	<b>16220</b>	16 ½	22	56 ⅝	29	29													
	COM cushions & frame		3½ yds		¾ yds														
	Fully upholstered						7	104	6,555	6,885	7,435	10,855	11,985	12,440	7,585	8,420	9,090	10,430	
	COM seat & back cushions, leather frame						3 ½	63		6,885		9,170	9,855	10,125					
<b>THREE SEAT SOFA</b>																			
	<b>16230</b>	16 ½	22	79 ¾	29	29													
	COM cushions & frame		5¼ yds		¾ yds														
	Fully upholstered						10	136	9,685	10,170	10,930	15,315	16,775	17,365	11,155	12,340	13,305	15,215	
	COM seat & back cushions, leather frame						5 ¼	81		10,170		13,045	13,915	14,270					
<b>OTTOMAN</b>																			
	<b>16250</b>	24 ½			20	16	1 ⅓	25	2,415	2,550	2,580	3,465	3,725	3,835	2,615	2,775	2,900	3,160	

Carlisle series passes CAL 133 certified for an upcharge of \$550 list per chair, \$975 list per two seater sofa, \$1460 list per three seat sofa, and \$485 list per ottoman. Certification applies to Nienkämper leathers and fabrics that have a minimum of 50% natural fibre content. COM's and COL's are subject to approval. Add the extension -CAL to the model number when ordering.

Legs and swivel disk base are upholstered to match the frame.

Swivel pedestal base is in brushed nickel finish.

When upholstered in leather, the two seat sofa (model 16220) has a center seam. When upholstered in fabric, the two seat sofa (model 16220) does not have a center seam.

When upholstering in two different fabrics, use the COM price and ship yardages as noted on page 7.

Model #16200  
Fully upholstered



Model #16240  
Fully upholstered in Grano leather G7084 Basalt



# LOUNGE SEATING

Dobi Designer – Nienkämper

– CND Only –

Model Number	Seat H"	W"	D"	H"	Fabric Yds.	Leather Sq. Ft.	COM	COL	Verde	Grano	Cremoso	Knoll Textiles									
												1	2	3	4						
11500	16	30	30	31	3	54							2,595	2,720	4,215	4,765	4,980	3,035	3,395	3,685	4,260

**DOBI**



**Model # 11500  
Dobi Chair**



- Standard Features:**
- 360 degree swivel base
  - Foam has 20% soy content

# LOUNGE SEATING

Dune Metal Designer – Busk + Hertzog

– CND Only –

Model Number	Seat H"	W"	D"	H"	Fabric Yds.	Leather Sq. Ft.	COM	COL	Neather	Verde	Grano	Cremoso	Knoll Textiles			
													1	2	3	4

## DUNE CHAIR



<b>10181</b>	15¾	33	31½	28½	4	54	3,750	3,940	4,055	5,455	5,715	5,980	4,340	4,815	5,200	5,965
--------------	-----	----	-----	-----	---	----	-------	-------	-------	-------	-------	-------	-------	-------	-------	-------

## DUNE 2 SEATER



<b>10182</b>	15¾	60½	31½	28½	6.5	117	6,185	6,495	6,835	9,775	10,335	10,905	7,140	7,915	8,545	9,790
--------------	-----	-----	-----	-----	-----	-----	-------	-------	-------	-------	--------	--------	-------	-------	-------	-------

## DUNE 3 SEATER

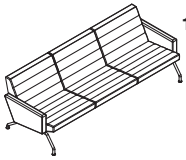

<b>10183</b>	15¾	88	31½	28½	10	180	8,610	9,045	9,605	14,070	14,950	15,825	10,080	11,270	12,235	14,145
--------------	-----	----	-----	-----	----	-----	-------	-------	-------	--------	--------	--------	--------	--------	--------	--------

Model # 10181  
Dune Chair



### Standard Features:

- Leg finish: mirror polish chrome, powder coat satin black

# LOUNGE SEATING

Elite Designer - Nienkämper

– CND Only –

Model Number	Seat H"	W"	D"	H"	Fabric		COM	COL	Neather	Verde	Grano	Cremoso	Knoll Textiles			
					Yds.	Sq. Ft.							1	2	3	4

## ELITE CHAIR WITH FIXED BASE

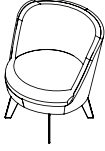

15411	17	28	27½	30	2¾	50	3,525	3,710	3,820	5,170	5,440	5,575	3,930	4,260	4,525	5,050
-------	----	----	-----	----	----	----	-------	-------	-------	-------	-------	-------	-------	-------	-------	-------

## ELITE CHAIR WITH SWIVEL BASE

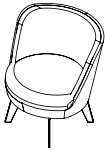

15412	17	28	27½	31¼	2¾	50	4,200	4,370	4,480	5,835	6,110	6,235	4,605	4,935	5,200	5,725
-------	----	----	-----	-----	----	----	-------	-------	-------	-------	-------	-------	-------	-------	-------	-------

Model # 15411



### Standard Features:

- Interior clearance of the seat is 24"W x 20"D
- Back with 2" thick lumbar foam wedge
- Swivel base is standard with 180 degree swivel and memory return
- Steel base is standard in Silver powder coat PC-01 or Black powder coat PC-06

# GATEWAY™ LOUNGE

## UPHOLSTERED LOUNGE ELEMENTS

Design - busk + hertzog

### Upholstered Lounge Elements:

#### Dimensions:

- 10 basic upholstered elements make up the Gateway Lounge system.
- Convex bench element for sofa: 40" w x 24 1/2" d x 17" h
- Convex sofa element: 40" w x 29 1/2" d x 32" h
- Convex symmetric bench element: 40" w x 24 1/2" d x 17" h
- Concave bench element for sofa: 41" w x 24 1/2" d x 17" h
- Concave sofa element: 41" w x 29 1/2" d x 32" h
- Concave symmetric bench element: 40" w x 24 1/2" d x 17" h
- Straight bench for sofa element: 28" w x 24 1/2" d x 17" h
- Straight sofa element: 28" w x 24 1/2" d x 32" h
- Straight symmetric bench element: 28" w x 24 1/2" d x 17" h
- 120° corner sofa element: 28" -48" w x 29 1/2" d x 32" h

#### Fabrics:

Gateway Lounge elements are available in a range of both solid matching pattern and colors and contrasting combinations. COM is also acceptable in most cases (contact customer service for details).



### Accessories:

#### Privacy Screens:

- Low and tall height integrated screens offer privacy and sound dampening to any convex, concave, straight & 120° corner sofa element.
- 120° corner sofa element standard has only one side with privacy screen, contact Customer Service if you require both sides with privacy screen.

#### Dimensions:

- Low height privacy screen: 34" h (for screen only), overall height with sofa is 44" h including 10" h overhang from floor.
- Tall height privacy screen: 49" h (for screen only), overall height with sofa is 59" h including 10" h overhang from floor.

#### Fabrics:

- Gateway Lounge Privacy Screens are available in COM and Knoll Textiles fabrics.



#### Screen Table:

- An optional, shallow 9" deep curved or straight table can be added to the low height privacy screen to allow for tiered seating and table top behind the sofa.
- 120° corner sofa element standard has only one side with screen table, contact Customer Service if you require both sides with screen table.

#### Dimensions:

- Convex/Concave Element: 42 1/2" w x 9" d x 3/4" thick
- Straight/120° Corner Element (one side only): 28" w x 9" d x 3/4" thick

#### Finishes:

Top is 3/4" thick with self edge available in Nienkämper standard veneers and finishes as well as plastic laminates.

#### Round Sofa Table:

A round table (14" dia) can also be added to any Gateway Lounge element, mounting to either front or back of the sofa or bench. The mounting bracket is silver powder coated finish as standard, other powder coat colors and chrome finish are also available with upcharge.

**Dimensions:** 14" dia x 3/4" thick

**Finishes:** Tops are 3/4" thick with self edge available in Nienkämper standard veneers and finishes as well as plastic laminates



# GATEWAY™ LOUNGE ELEVATION

## Gateway Lounge Elements with Accessories

Side elevation shows Gateway Sofa with low height screen & 9" deep top

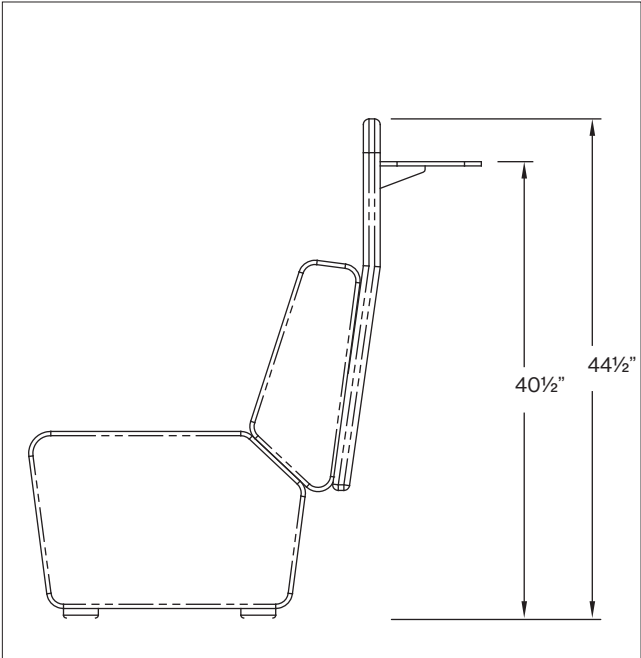

Side elevation shows Gateway Sofa with round table mounted to back

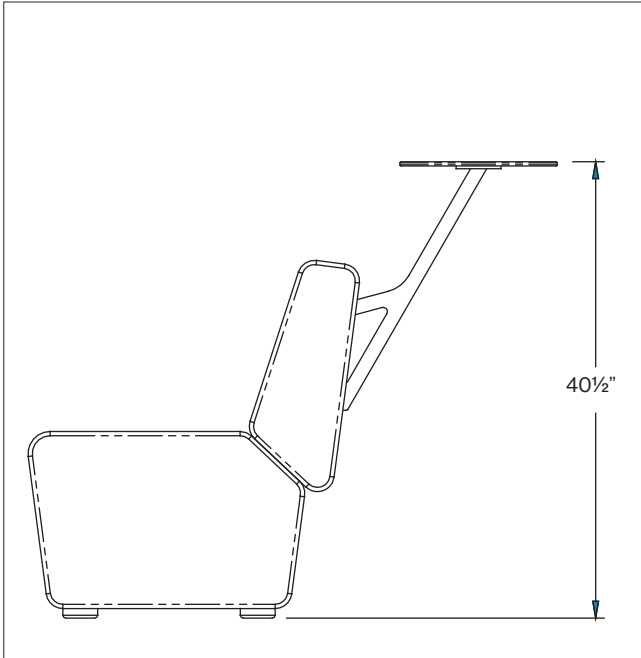

Side elevation shows Gateway Sofa with round table mounted to front

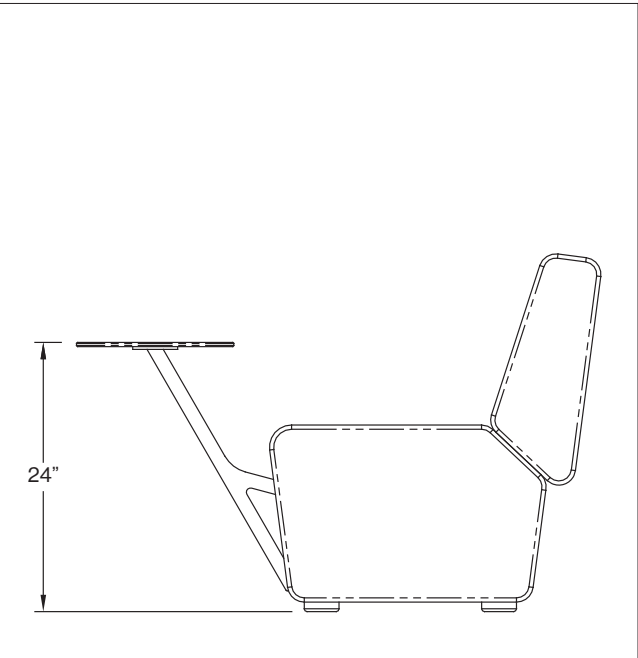

Side elevation shows Gateway Sofa with tall height screen

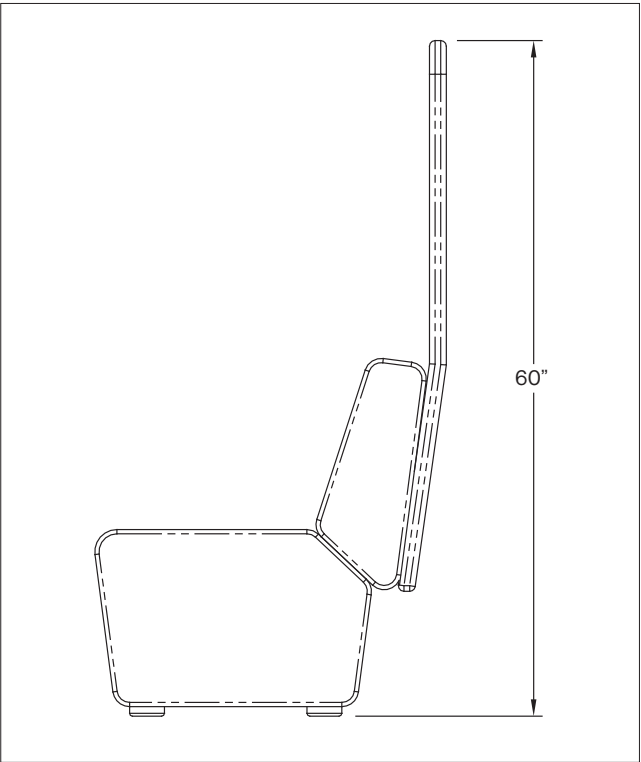

# GATEWAY™ LOUNGE LAYOUT

## Gateway Lounge Elements Configuration

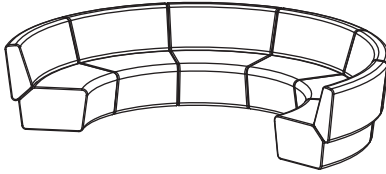
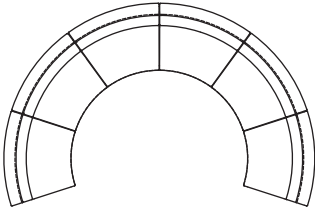

6 concave sofa elements

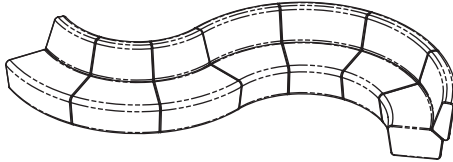
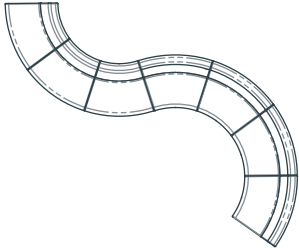

3 convex sofa elements  
4 concave sofa elements

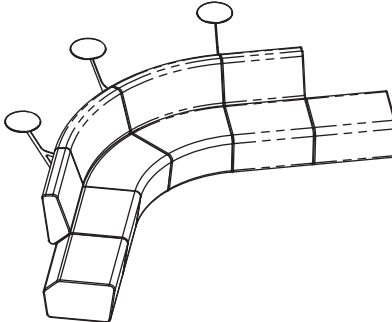
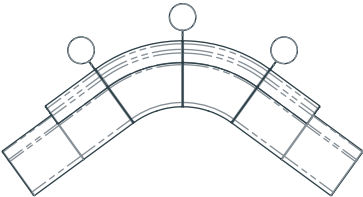

2 concave sofa elements  
2 straight sofa elements  
2 straight bench elements  
3 round sofa tables

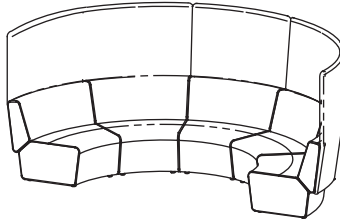
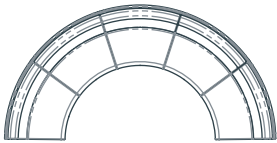

5 convex sofa elements  
5 concave sofa elements

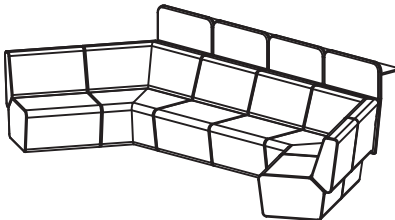
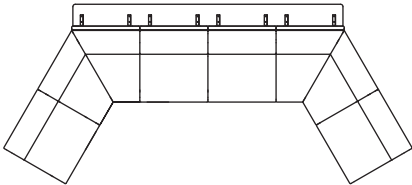





4 straight sofa elements  
2 120 degree corner sofa elements  
4 straight low screen with 9" deep top

# GATEWAY™ LOUNGE ELEMENTS

## SOFA ELEMENTS

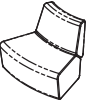
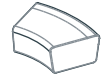
— US ONLY —

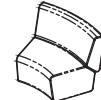
	Model Number	Seat				Fabric			Leather				Knoll Textiles			
		H"	W"	D"	H"	Yrds.	Sq. Ft.	COM	COL	Verde	Grano	Cremoso	1	2	3	4
<b>CONVEX</b>																
SYMMETRIC BENCH ELEMENT																
	11410	17	40	24 <sup>5</sup> / <sub>8</sub>	17	2 <sup>1</sup> / <sub>4</sub>	108	2,590	2,720	3,685	3,940	4,340	2,855	3,030	3,240	3,445
BENCH ELEMENT FOR SOFA																
	11411	17	40	24 <sup>5</sup> / <sub>8</sub>	17	2 <sup>1</sup> / <sub>4</sub>	108	2,590	2,720	3,685	3,940	4,340	2,855	3,030	3,240	3,445
SOFA ELEMENT																
	11412	17	40	29 <sup>1</sup> / <sub>2</sub>	32	4 <sup>1</sup> / <sub>2</sub>	108	4,595	4,830	6,755	7,280	8,070	5,115	5,475	5,900	6,300
<b>CONCAVE</b>																
SYMMETRIC BENCH ELEMENT																
	11420	17	28	24 <sup>5</sup> / <sub>8</sub>	17	2	108	2,590	2,720	3,685	3,940	4,340	2,855	3,030	3,240	3,445
BENCH ELEMENT FOR SOFA																
	11413	17	28	24 <sup>5</sup> / <sub>8</sub>	17	2 <sup>1</sup> / <sub>4</sub>	108	2,590	2,720	3,685	3,940	4,340	2,855	3,030	3,240	3,445
SOFA ELEMENT																
	11414	17	41	29 <sup>1</sup> / <sub>2</sub>	32	4 <sup>1</sup> / <sub>2</sub>	108	4,595	4,830	6,755	7,280	8,070	5,115	5,475	5,900	6,300

**Features:**

- Gateway™ upholstered lounge elements include linear and curved modular components which enable the customer to create their own solution.
- Element styles are bench, sofa and sofa with integrated privacy screen.







# GATEWAY™ LOUNGE ELEMENTS

## SOFA ELEMENTS

— CND ONLY —

KnollTextiles

Model Number	Seat H"	W"	D"	H"	Private Lounger Width Sq. Ft.	CEN	COL	Mesh	Canvas	Corona	1	2	3	4					
<b>STRAIGHT</b>																			
<b>SYMMETRIC BENCH ELEMENT</b>																			
	8417	17	28	24"	17	26	108				2,485	2,480	3,520	3,805	4,180	2,795	3,085	3,285	3,795
<b>BENCH ELEMENT FOR SOFA</b>																			
	8415	17	28	24"	17	26	108				2,485	2,480	3,520	3,805	4,180	2,795	3,085	3,285	3,795
<b>SOFA ELEMENT</b>																			
	8418	17	28	25"	32	46	108				4,480	4,885	6,800	7,250	7,885	5,320	5,855	6,090	6,855
<b>130 CHAIR</b>																			
<b>BENCH ELEMENT FOR SOFA</b>																			
	8419		34	37"	17	5	28				4,810	4,885	7,030	7,590	2,580	5,845	6,240	6,720	7,880
<b>SOFA ELEMENT</b>																			
	8420		38"	37"	32	9	28				9,800	9,545	13,885	14,280	15,780	10,225	11,285	12,180	13,885

**Features:**





- Gateway™ upholstered lounge elements include linear curved and corner modular components which enable the customer to create their own solution.
- Elements styles are bench, sofa and sofa with integrated privacy screen.

# GATEWAY™ LOUNGE ELEMENTS

## SOFA ELEMENTS

— CND ONLY —

Executive Edition







Model Number	Seat HP	W*	DP	HP	Polster Leather Trk. Sq. Ft.	CON	COL	Woods	Stains	Carpet	1	2	3	4	
<b>PRIVACY SCREEN</b>															
	<b>CONVEX</b>														
	1921	Full-height	42%	59	3	54	1,950	1,730	3,085	3,440	3,670	2,080	2,450	2,740	3,315
	1922	Low-height	42%	44	2	39	1,390	1,405	2,340	2,555	2,655	1,855	1,900	2,085	2,070
1923	Low-height with 1" drop-off	42%	44	2	39	1,840	2,040	2,920	3,195	3,475	2,235	2,475	2,685	3,045	
<b>CONCAVE</b>															
															
	1924	Full-height	42%	59	3	54	1,950	1,730	3,085	3,440	3,670	2,080	2,450	2,740	3,315
	1925	Low-height	42%	44	2	39	1,390	1,405	2,340	2,555	2,655	1,855	1,900	2,085	2,070
1926	Low-height with 1" drop-off	42%	44	2	39	1,840	2,040	2,920	3,195	3,475	2,235	2,475	2,685	3,045	
<b>STRAIGHT (for straight or 90° corner elements)</b>															
															
	1927	Full-height	28	59	3	54	1,195	1,355	2,380	2,565	3,430	1,835	1,980	2,280	2,890
	1928	Low-height	28	44	2	39	1,090	1,135	2,035	2,280	2,590	1,375	1,615	1,905	2,195
1929	Low-height with 1" drop-off	28	44	2	39	1,480	1,590	2,485	2,685	3,000	1,780	2,025	2,215	2,595	
<b>ROUND OF TABLE</b>															
	1931					14 sq.	1,505								

### Features:

- Privacy screens can be contrasting or matching fabrics
- Table top is 1/2" thick 304 edge available in Nienkämper veneers & P-lam.

# GATEWAY™ LOUNGE ELEMENTS SOFA ELEMENTS

— CND ONLY —

	Model Number	Seat H"	W"	D"	H"	Fabric Location		Knoll Tufting								
						Tvds.	Sp. PL.	CSH	COL.	Wtds.	Blnds.	Corrns.	1	2	3	4
<b>CONDOR</b>																
<b>SYMMETRIC BENCH ELEMENT</b>																
	8410	17	40	34 1/2	17	26	108	2,590	2,720	3,895	3,940	4,340	2,990	3,190	3,440	3,640
<b>BENCH ELEMENT FOR SOFA</b>																
	8411	17	40	34 1/2	17	26	108	2,590	2,720	3,895	3,940	4,340	2,990	3,190	3,440	3,640
<b>SOFA ELEMENT</b>																
	8412	17	40	28 1/2	32	46	108	4,695	4,830	6,765	7,280	8,070	5,390	5,795	6,230	7,090
<b>CONDOR</b>																
<b>SYMMETRIC BENCH ELEMENT</b>																
	8430	17	28	34 1/2	17	2	108	2,590	2,720	3,895	3,940	4,340	2,990	3,190	3,440	3,640
<b>BENCH ELEMENT FOR SOFA</b>																
	8431	17	28	34 1/2	17	26	108	2,590	2,720	3,895	3,940	4,340	2,990	3,190	3,440	3,640
<b>SOFA ELEMENT</b>																
	8414	17	41	28 1/2	32	46	108	4,695	4,830	6,765	7,280	8,070	5,390	5,795	6,230	7,090

**Features:**

- Gateway™ upholstered lounge elements include linear and curved modular components which enable the customer to create their own solution.
- Element styles are bench, sofa and sofa with integrated privacy screen.



# LOUNGE SEATING

Godbout Designer – Charles Godbout

– CND Only –

Model Number	Seat H"	Arm H"	W"	D"	H"	Fabric Yds.	Leather Sq. Ft.	COM	COL	Verde	Grano	Cremoso	Knoll Textiles			
													1	2	3	4

## LOUNGE CHAIR

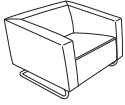

12201	14	22½	33	30	25¼	4	75	5,205	5,475	7,715	8,440	8,705	5,795	6,270	6,655	7,420
-------	----	-----	----	----	-----	---	----	-------	-------	-------	-------	-------	-------	-------	-------	-------

## TWO SEAT SOFA

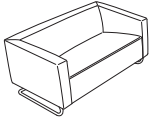

12202	14	22½	56	30	25¼	6	110	6,395	6,730	10,110	11,150	11,545	7,280	7,995	8,570	9,720
-------	----	-----	----	----	-----	---	-----	-------	-------	--------	--------	--------	-------	-------	-------	-------

## THREE SEAT SOFA

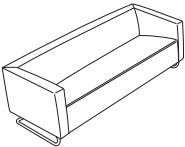

12203	14	22½	82	30	25¼	7½	140	7,700	8,095	12,435	13,750	14,265	8,800	9,695	10,420	11,850
-------	----	-----	----	----	-----	----	-----	-------	-------	--------	--------	--------	-------	-------	--------	--------

Model # 12201



### Standard Features:

- Plywood frame construction
- Seat and back are webbed
- Polyurethane foam
- Fortrel® on seat, back and arms
- Reinforced tubular steel base in chrome powder coat finish

# LOUNGE SEATING

Heartbeat Designer - Karim Rashid

– CND Only –

Model Number	Seat H"	Arm H"	W"	D"	H"	Fabric Yds.	COM	Knoll Textiles			
								1	2	3	4

## HEARTBEAT CONVEX ELEMENT

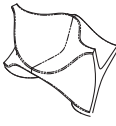
	10401	17	51	37 $\frac{3}{4}$	31 $\frac{1}{2}$	5 $\frac{1}{2}$	4,720	5,530	6,185	6,715	7,765
--	-------	----	----	------------------	------------------	-----------------	-------	-------	-------	-------	-------

## HEARTBEAT CONCAVE ELEMENT

	10402	17	54 $\frac{1}{4}$	32	31 $\frac{1}{2}$	5 $\frac{1}{2}$	4,720	5,455	6,050	6,535	7,490
--	-------	----	------------------	----	------------------	-----------------	-------	-------	-------	-------	-------

## HEARTBEAT STRAIGHT ELEMENT

	10403	17	40	35	31 $\frac{1}{2}$	5 $\frac{1}{2}$	4,490	5,300	5,955	6,485	7,535
--	-------	----	----	----	------------------	-----------------	-------	-------	-------	-------	-------

## HEARTBEAT CONVEX TABLE ELEMENT

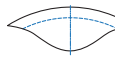
	Finish	W"	D"	Thick-ness"		
	10404/2	Veneer	35 $\frac{5}{16}$	12 $\frac{3}{8}$	1 $\frac{1}{4}$	1,460
	10404/5	P-Lam	35 $\frac{5}{16}$	12 $\frac{3}{8}$	1 $\frac{1}{4}$	1,300

## HEARTBEAT CONCAVE TABLE ELEMENT

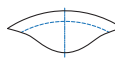
	10405/2	Veneer	32 $\frac{5}{16}$	11 $\frac{13}{16}$	1 $\frac{1}{4}$	1,460
	10405/5	P-Lam	32 $\frac{5}{16}$	11 $\frac{13}{16}$	1 $\frac{1}{4}$	1,300

### Standard Features:

- Rigid core frame with durable foam cover.
- Convex/Concave/Straight sofa elements can be arranged in limitless quantity and configuration to create double sided seating.
- Optional Convex/Concave table element with 3" taper edge mounts between sofa elements to frame with metal support.
- Optional dual USB Charger can be added to underside of table.

### Note:

Fabric with 4 way stretch is recommended on Heartbeat chair, COM should be approved by Nienkämper factory.



# LOUNGE SEATING

Heartbeat Designer - Karim Rashid

– CND Only –

## Heartbeat Layout

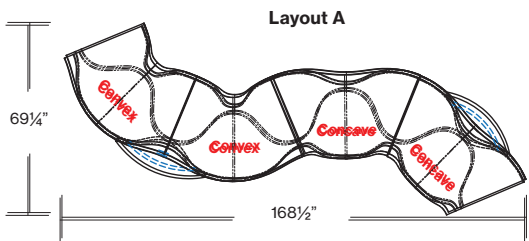
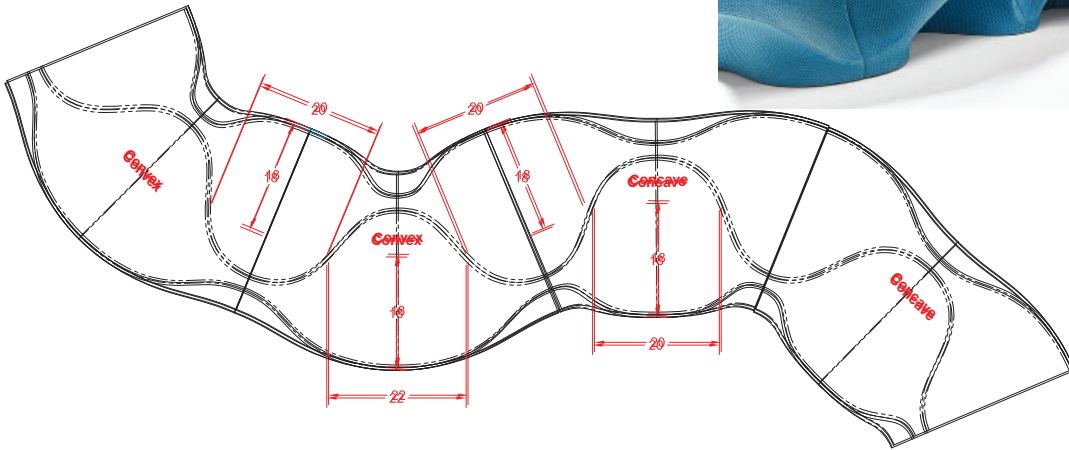

Layout "A" consists of:  
 4 Sofa Elements & 2 Table Elements providing a total of 7 Seats  
 From left to right: Convex Sofa Element #10401, Convex Table Element #10404/5, Convex Sofa Element #10401, Concave Sofa Element #10402, Concave Sofa Element #10402, Concave Table Element #10405/5

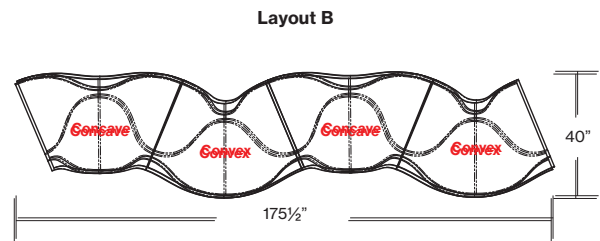

Layout "B" consists of:  
 4 Sofa Elements providing a total of 7 Seats  
 From left to right: Concave Sofa Element #10402, Convex Sofa Element #10401, Concave Sofa Element #10402, Convex Sofa Element #10401

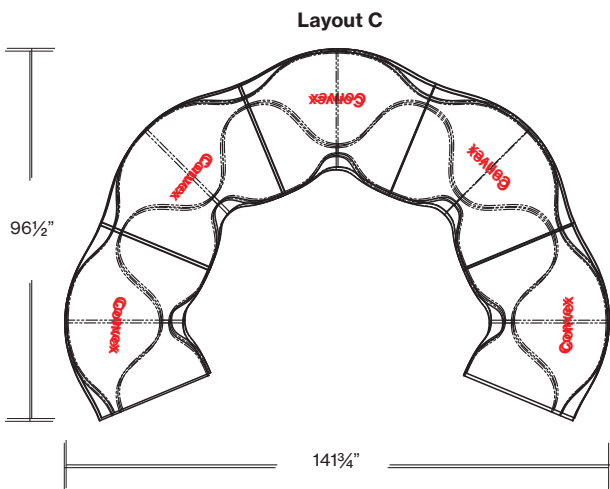

Layout "C" consists of:  
 5 Sofa Elements providing a total of 9 Seats  
 From left to right: Convex Sofa Element #10401, Convex Sofa Element #10401, Convex Sofa Element #10401, Convex Sofa Element #10401, Convex Sofa Element #10401

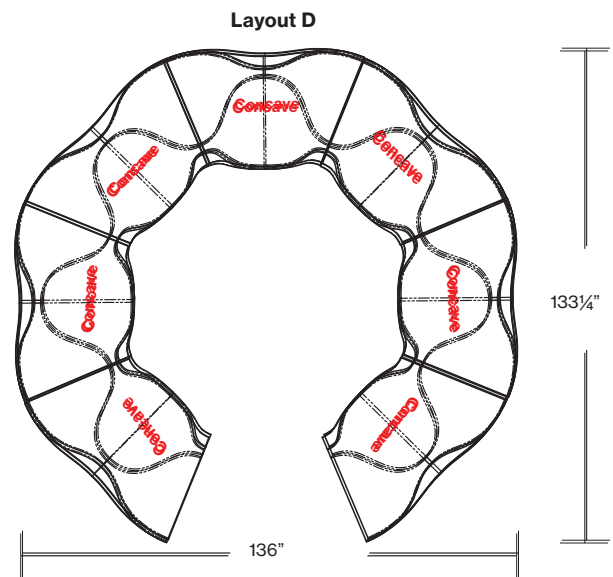

Layout "D" consists of:  
 7 Sofa Elements providing a total of 13 Seats  
 From left to right: Concave Sofa Element #10402, Concave Sofa Element #10402, Concave Sofa Element #10402, Concave Sofa Element #10402, Concave Sofa Element #10402, Concave Sofa Element #10402, Concave Sofa Element #10402

# LOUNGE SEATING

Isola 8 Designer – Karim Rashid

– CND Only –

Model Number	Seat H"	W"	D"	H"	Fabric Yds.	Leather Sq. Ft.	COM	COL	Verde	Grano	Cremoso	Knoll Textiles			
												1	2	3	4

## ISOLA 8



### 10210

Fully	16	110	70	32	15 ½	126	16,190	17,010	24,560	27,340	28,280	18,465	20,310	21,805	24,765
Back					8 ½	153									
Seat					7	280									

#### Frame:

- Birch plywood .

#### Seat and Back:

- Soy based foam and Fortrel.

#### Base:



- Painted Mdf Base.



# LOUNGE SEATING

J + J Studio Sofa Designer - MSDS Studio

– CND Only –

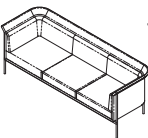
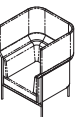
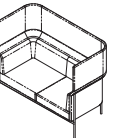
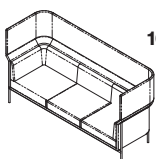
Model Number	Seat H"	W"	D"	H"	Fabric Yds.	Leather Sq. Ft.	COM	COL	Neather	Verde	Grano	Cremoso	Knoll Textiles					
													1	2	3	4		
<b>J + J STUDIO LOW BACK LOUNGE CHAIR</b>																		
	10271	17	35	30 3/4	33	Fully upholstered	6	108	5,425	5,700	6,045	8,855	9,430	9,715	6,310	7,020	7,600	8,750
						COM cushions, leather frame	3	52		5,700		7,270	7,575	7,705				
<b>J + J STUDIO LOW BACK 2 SEAT SOFA</b>																		
	10272	17	59	30 3/4	33	Fully upholstered	8 1/2	153	7,920	8,320	8,790	12,790	13,610	14,025	9,170	10,180	11,000	12,625
						COM cushions, leather frame	4 1/4	75		8,320		10,570	10,985	11,185				
<b>J + J STUDIO LOW BACK 3 SEAT SOFA</b>																		
	10273	17	85	30 3/4	33	Fully upholstered	11 3/4	212	9,550	10,025	10,750	16,230	17,355	17,910	11,280	12,675	13,810	16,055
						COM cushions, leather frame	6 3/4	90		10,025		12,660	13,140	13,380				
<b>J + J STUDIO HIGH BACK LOUNGE CHAIR</b>																		
	10275	17	35	30 3/4	49	Fully upholstered	8 1/4	149	6,520	6,825	7,365	11,185	11,985	12,375	7,730	8,710	9,510	11,085
						COM cushions, leather frame	3	95		6,825		9,605	10,115	10,365				
<b>J + J STUDIO HIGH BACK 2 SEAT SOFA</b>																		
	10276	17	59	30 3/4	49	Fully upholstered	11 1/2	207	9,510	9,975	10,685	16,030	17,130	17,680	11,200	12,565	13,680	15,880
						COM cushions, leather frame	4 1/4	130		9,975		13,780	14,470	14,805				
<b>J + J STUDIO HIGH BACK 3 SEAT SOFA</b>																		
	10277	17	85	30 3/4	49	Fully upholstered	15 1/4	275	11,455	12,030	13,010	20,080	21,540	22,260	13,695	15,505	16,980	19,895
						COM cushions, leather frame	6 3/4	153		12,030		16,510	17,320	17,715				

**Standard Features:**

- Solid maple and plywood construction frame wrapped with foam
- Seat and back cushions have molded foam inside and wrapped in Dacron.
- Exposed steel frame available in clear coated raw finish, polished chrome, brushed chrome and black powder coat finish.

Model # 10277 J + J Studio high back 3 seat sofa



Model # 10273 J + J Studio low back 3 seat sofa



Frame upholstered in Ecopell leather, Blueberry EC700

# LOUNGE SEATING

Kloud® Designer – Karim Rashid

– CND Only –

Model Number	Seat Arm		W"	D"	H"	Fabric Leather		COM	COL	Verde	Grano	Cremoso	Knoll Textiles			
	H"	H"				Yds.	Sq. Ft.						1	2	3	4

## CHAIR



Fully upholstered

**14981** 17 24½ 38 28 ½ 31 4 ½ 81

3,265 3,430 5,925 6,630 6,910 3,925 4,460 4,895 5,755

## TWO SEAT SOFA

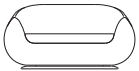

Fully upholstered

**14984** 17 24½ 63 28 ½ 31 6 108

5,645 5,925 9,015 10,210 11,000 6,530 7,240 7,820 8,970

## THREE SEAT SOFA

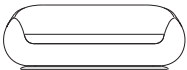

Fully upholstered

**14987** 17 24½ 86 28 ½ 31 7 ½ 135

8,340 8,760 12,650 14,170 14,975 9,440 10,335 11,060 12,490

**Kloud Collection passes CAL 133 certified for an upcharge of \$550 list per chair, \$975 list per 2 seat sofa and \$1,460 list per 3 seat sofa. Certification applies to Nienkämper leathers and fabrics that have a minimum of 50% natural fibre content. COM's and COL's are subject to approval. Add the extension -CAL to the model number when ordering.**

Laminated wood base frame with rubber webbing under the fixed cushion. The foam body is supported with a tubular steel frame inside.

The seat and back are polyurethane foam covered in Fortrel®. Upholstered in leather or fabric.

The swivel base is painted silver. The swivel base can be upholstered to match the frame;  
 add ⅔ yds 6 sq. ft. chair  
 add ⅔ yds 12 sq. ft. two seat sofa  
 add 1⅓ yds 18 sq. ft. three seat sofa





The curvaceous shape and soft molded foam of the Kloud chair are conducive to fabrics with some stretch and minimum pattern. COM fabrics should be approved by customer service. (800.668.9318)

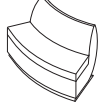
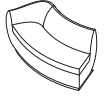

# LOUNGE SEATING

Kloud® Serpentine™ Designer – Karim Rashid

– CND Only –

	Model Number	Seat H"	Arm H"	W"	D"	H"	Fabric Yds.	Leather Sq. Ft.	COM	COL	Verde	Grano	Cremoso	Knoll Textiles			
														1	2	3	4
<b>CONVEX</b>																	
<b>Right end</b>	<b>14994</b>	17	25 ¾	73	28 ½	30 ½	6 ¾	122	5,280	5,530	9,105	10,535	10,975	6,270	7,075	7,725	9,015
																	
<b>Centre element</b>	<b>14991</b>	17		54	28 ½	30 ½	4 ¾	86	3,490	3,665	6,190	7,205	7,500	4,185	4,755	5,210	6,120
																	
<b>Left end</b>	<b>14993</b>	17	25 ¾	73	28 ½	30 ½	6 ¾	122	5,280	5,530	9,105	10,535	10,975	6,270	7,075	7,725	9,015
																	
<b>CONCAVE</b>																	
<b>Right end</b>	<b>14997</b>	17	25 ¾	67	28 ½	30 ½	7	126	5,610	5,880	9,570	11,040	11,490	6,640	7,475	8,145	9,485
																	
<b>Centre element</b>	<b>14992</b>	17		52	28 ½	30 ½	5	90	3,855	4,055	6,705	7,740	8,080	4,590	5,185	5,665	6,625
																	
<b>Left end</b>	<b>14996</b>	17	25 ¾	67	28 ½	30 ½	7	126	5,610	5,880	9,570	11,040	11,490	6,640	7,475	8,145	9,485
																	
<b>STRAIGHT</b>	<b>14995</b>	17		24	28 ½	30 ½	2 ½	45	3,220	3,375	3,960	4,245	4,340	3,590	3,885	4,130	4,605
																	

**Frame:**

Laminated wood base frame with rubber webbing under the fixed cushion. The foam body is supported with a tubular steel frame inside.

**Seat and Back:**

The seat and back are polyurethane foam, seat covered in Fortrel®. Upholstered in leather or fabric.

**Base:**

The base is painted silver.

The curvaceous shape and soft molded foam of the Kloud chair are conducive to fabrics with some stretch and minimum pattern. COM fabrics should be approved by customer service. (800.668.9318)

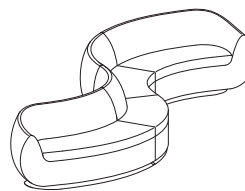

**Consists of (from Left to Right when facing) :**

- 1 x **14993** Convex Left End
- 1 x **14991** Convex Centre Element
- 1 x **14992** Concave Centre Element
- 1 x **14997** Concave Right End

# LOUNGE SEATING

Leaf Designer - Busk + Hertzog

– CND Only –

Model Number	Seat H"	Arm H"	W"	D"	H"	Fabric Yds.	Leather Sq. Ft.	COM	COL	Neather	Verde	Grano	Cremoso	Knoll Textiles 1	Knoll Textiles 2	Knoll Textiles 3	Knoll Textiles 4
--------------	---------	--------	----	----	----	-------------	-----------------	-----	-----	---------	-------	-------	---------	------------------	------------------	------------------	------------------

## LEAF CHAIR



10310	17		36½	28	25¼	2½	45	3,585	3,745	3,810	4,830	5,055	5,160	3,950	4,250	4,490	4,970
-------	----	--	-----	----	-----	----	----	-------	-------	-------	-------	-------	-------	-------	-------	-------	-------

Model # 10310



### Standard Features:

- Seat with plywood shell
- Soy based flexible polyurethane foam for seat & back
- Polished chrome base

Fabric to be upholstered on Leaf Chair needs to be approved by Nienkämper Factory, please contact Customer Service at 800 668 9318 for our fabric approval list.



# LOUNGE SEATING

Nordic Designer - Nienkämper

— CND Only —

Model Number	Seat H"	W"	D"	H"		Fabric Yds.	Leather Sq. Ft.	COM	COL	Neather	Verde	Grano	Cremoso	Knoll Textiles			
														1	2	3	4

## NORDIC



10262	16½	28	26	29½	2	36		3,400	3,570	3,610	4,595	4,800	4,910	3,695	3,935	4,125	4,505
-------	-----	----	----	-----	---	----	--	-------	-------	-------	-------	-------	-------	-------	-------	-------	-------

Model # 10262



### Standard Features:

- Molded plywood frame
- Seat and back cushions with polyurethane foam
- Base is beech plywood available in natural finish and standard Nienkämper paint finish
- Custom stained to match on the base is also available with upcharge

# LOUNGE SEATING

Note Designer - Busk + Hertzog

– CND Only –

Model Number	Seat Arm		W"	D"	H"	Fabric Leather		COM	COL	Neather	Verde	Grano	Cremoso	Knoll Textiles			
	H"	H"				Yds.	Sq. Ft.							1	2	3	4

## NOTE CHAIR ON GLIDES

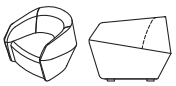

<b>10651</b>	16	25¼	33	34½	27¾	5½	99
--------------	----	-----	----	-----	-----	----	----

4,125	4,335	4,680	7,105	7,585	8,065	4,930	5,590	6,120	7,170
-------	-------	-------	-------	-------	-------	-------	-------	-------	-------

## NOTE CHAIR WITH SWIVEL DISK

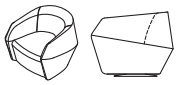

<b>10654</b>	16	25¼	33	34½	27¾	6½	113
--------------	----	-----	----	-----	-----	----	-----

4,460	4,685	5,110	7,845	8,395	8,950	5,415	6,185	6,815	8,060
-------	-------	-------	-------	-------	-------	-------	-------	-------	-------

## NOTE TWO SEAT SOFA

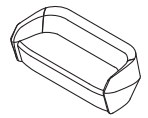

<b>10652</b>	16	25¼	69	34½	27¾	8½	153
--------------	----	-----	----	-----	-----	----	-----

5,595	5,875	6,445	10,155	10,900	11,640	6,845	7,855	8,675	10,300
-------	-------	-------	--------	--------	--------	-------	-------	-------	--------

## NOTE THREE SEAT SOFA

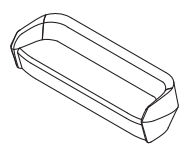

<b>10653</b>	16	25¼	93	34½	27¾	9½	171
--------------	----	-----	----	-----	-----	----	-----

7,000	7,350	7,950	12,130	12,965	13,805	8,395	9,525	10,445	12,260
-------	-------	-------	--------	--------	--------	-------	-------	--------	--------

### Standard Features:

- Frame is constructed of hardwood, plywood and soy based polyurethane foam.
- Note chair is available on glides or with swivel disk in upholstery finish.
- Contrasting stitching can be specified on outside back with no upcharge.

Optional contrast stitching on outside back:

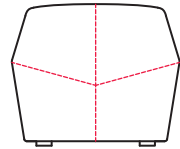

Back Elevation

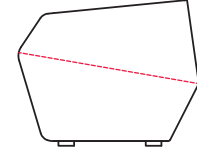

Side Elevation

Model # 10651  
Note chair



Model # 10652  
Note two seat sofa



Model # 10651 & 10653  
Note chair & three seat sofa with Mint Stools

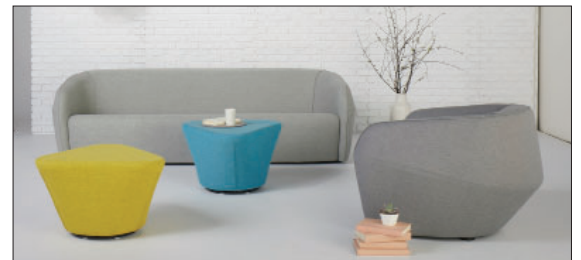

# LOUNGE SEATING

Radius Designer - Christopher Panichella

– CND Only –

Model Number	Seat Arm			D"	H"	Fabric Yds.	Leather Sq. Ft.	COM	COL	Neather	Verde	Grano	Cremoso	Knoll Textiles			
	H"	H"	W"											1	2	3	4

## RADIUS LOW BACK - WITH WOOD BACK



10770	16	27	33¼	33	29	3½	63	6,420	6,670	6,520	8,590	8,960	9,135	6,930	7,350	7,690	8,355
-------	----	----	-----	----	----	----	----	-------	-------	-------	-------	-------	-------	-------	-------	-------	-------

## RADIUS LOW BACK - FULLY UPHOLSTERED



10771	16	27	33¼	33	29	4½	81	5,035	5,290	5,530	7,750	8,225	8,470	5,700	6,235	6,670	7,530
-------	----	----	-----	----	----	----	----	-------	-------	-------	-------	-------	-------	-------	-------	-------	-------

## RADIUS HIGH BACK

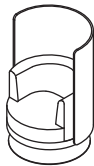

10772	16	27	33¼	33	48	6¾	122	7,930	8,335	8,675	12,065	12,765	13,115	8,920	9,725	10,375	11,670
-------	----	----	-----	----	----	----	-----	-------	-------	-------	--------	--------	--------	-------	-------	--------	--------

## ACCESSORIES

### TABLET ARM



12461			20	12	½			1,665									
-------	--	--	----	----	---	--	--	-------	--	--	--	--	--	--	--	--	--

### CUP HOLDER



10774			4 dia					680									
-------	--	--	-------	--	--	--	--	-----	--	--	--	--	--	--	--	--	--

## POWER

### Simple Dot Forums



White receptacle, model #11867/W \$315 list



White stacked USB, model #11868/W \$545 list



Black receptacle, model #11967/B \$315 list



Black stacked USB, model # 11868/B \$545 list

Model # 10770  
Radius low back  
with wood back



Radius low back upholstered in Ecopell leather Blackberry EC100

Model # 10772  
Radius high back with  
tablet, cup holder & power



### Standard Features:

- Seat depth: 22"d
- Seat and back cushions have a foam core with Dacron wrap.
- Disk base standard in brushed finish.
- Radius Low Back chair is available with wood back on exterior. Select from standard Nienkämper veneer & stains.
- Radius High Back chair is only available fully upholstered.

### Optional Features:

- Tablet top available in pure White or Black ½" thick Fingerprint Resistance solid material.
- Tablet arm support in silver or white powder coat finish
- Cup holder available in polished or brushed aluminum.
- Cup holder top with leather or vinyl inset in white or black as standard.
- Power Outlet or stacked USB Charger with 72" cord in white or black finish.



Tablet arm available in white or silver finish

# LOUNGE SEATING

Radius on Legs Designer - Christopher Panichella

— CND Only —

Model Number	Seat Arm		W"	D"	H"	Fabric Yds.	Leather Sq. Ft.	COM	COL	Neather	Verde	Grano	Cremoso	Knoll Textiles			
	H"	H"												1	2	3	4

## RADIUS LOW BACK - WITH WOOD BACK

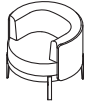

10775	16	28¼	33½	32¾	28¼	3½	63	6,280	6,535	6,360	8,450	8,810	9,000	6,795	7,215	7,550	8,220
-------	----	-----	-----	-----	-----	----	----	-------	-------	-------	-------	-------	-------	-------	-------	-------	-------

## RADIUS LOW BACK - FULLY UPHOLSTERED



10776	16	28¼	33½	32¾	28¼	4½	81	4,900	5,145	5,385	7,625	8,085	8,325	5,560	6,100	6,535	7,395
-------	----	-----	-----	-----	-----	----	----	-------	-------	-------	-------	-------	-------	-------	-------	-------	-------

## RADIUS HIGH BACK

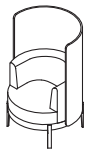

10777	16	28¼	33½	32¾	47½	6¾	122	7,810	8,200	8,540	11,920	12,620	12,985	8,800	9,605	10,255	11,545
-------	----	-----	-----	-----	-----	----	-----	-------	-------	-------	--------	--------	--------	-------	-------	--------	--------

## ACCESSORIES

### TABLET ARM



12461			20	12	½			1,665									
-------	--	--	----	----	---	--	--	-------	--	--	--	--	--	--	--	--	--

### CUP HOLDER



10774			4 dia					680									
-------	--	--	-------	--	--	--	--	-----	--	--	--	--	--	--	--	--	--

## POWER

### Simple Dot Forums



White receptacle, model #11867/W \$315 list



White stacked USB, model #11868/W \$545 list



Black receptacle, model #11967/B \$315 list



Black stacked USB, model # 11868/B \$545 list

Model # 10777  
Radius on legs



Tablet arm available in white or silver finish



### Standard Features:

- Seat depth: 22"d
- Seat and back cushions have a foam core with Dacron wrap.
- Legs standard in mirror polish.
- Radius Low Back chair is available with wood back on exterior. Select from standard Nienkämper veneer & stains.
- Radius High Back chair is only available fully upholstered.

### Optional Features:

- Tablet top available in pure White or Black ½" thick Fingerprint Resistance solid material.
- Tablet arm support in silver or white powder coat finish
- Cup holder available in polished or brushed aluminum.
- Cup holder top with leather or vinyl inset in white or black as standard.
- Power Outlet or stacked USB Charger with 72" cord in white or black finish.

# LOUNGE SEATING

Rowan Lounge Collection Designer - Yabu Pushelburg

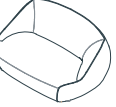
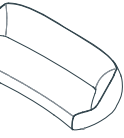
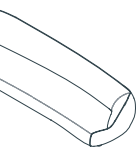
Model Number	Seat		D"	H"	Fabric		COM	COL	Neather	Verde	Grano	Cremoso	- CND Only - KnollTextiles					
	H"	W"			Yds.	Sq. Ft.							1	2	3	4		
<b>ROWAN LOUNGE CHAIR</b>																		
	<b>10660</b> on glides	16	34 $\frac{7}{8}$	36	27 $\frac{3}{4}$	5.5	99	4,545	4,775	5,090	7,540	8,340	11,275	5,350	6,010	6,540	7,590	
	<b>10661</b> swivel base	16	34 $\frac{7}{8}$	36	27 $\frac{3}{4}$	5.5	99	4,715	4,955	5,275	7,730	8,530	11,460	5,525	6,180	6,710	7,760	
<b>ROWAN LARGE LOUNGE CHAIR</b>																		
	<b>10662</b>	16	52 $\frac{7}{8}$	36	27 $\frac{3}{4}$	6.5	117	5,215	5,480	5,870	8,755	9,320	9,895	6,170	6,945	7,575	8,815	
<b>ROWAN 2-SEATER SOFA</b>																		
	<b>10663</b>	16	82 $\frac{7}{8}$	36	27 $\frac{3}{4}$	7	126	6,155	6,465	6,860	9,995	10,605	11,215	7,185	8,020	8,690	10,030	
<b>ROWAN 3-SEATER SOFA</b>																		
	<b>10664</b>	16	118 $\frac{7}{8}$	36	27 $\frac{3}{4}$	8	144	7,700	8,085	8,500	12,115	12,820	13,515	8,875	9,825	10,595	12,130	

**Standard Features:**

- Constructed from soy based polyurethane foam over rigid frame
- Sofa sits on glides
- Lounge Chair is available on glides or swivel base

**Model # 10661**  
Rowan Arm Lounge Chair upholstered in Knoll Velvetk 784/74 Moss



**Model # 10664**  
Rowan Lounge 3 Seater Sofa upholstered in Maharam 466420 Huddle Pottery 002



# LOUNGE SEATING

Satori™ & Satori™ with Tablet Arm Designer - Mark Saffell & David Ritch

— CND Only —

Model Number	Seat H"	Arm H"	W"	D"	H"	Fabric Yds.	Leather Sq. Ft.	COM	COL	Neather	Verde	Grano	Cremoso	Knoll Textiles			
														1	2	3	4

## SATORI



<b>23201</b>	17 ½	28 ½	26 ½	25	30	3 ½	52	3,390	3,555	3,825	5,540	6,115	6,340	3,905	4,325	4,660	5,325
--------------	------	------	------	----	----	-----	----	-------	-------	-------	-------	-------	-------	-------	-------	-------	-------

## SATORI WITH LOW ARM



<b>23203</b>	17 ½	24 ¾	26 ½	25	30	3 ½	50	3,285	3,460	3,725	5,455	6,025	6,240	3,800	4,220	4,555	5,220
--------------	------	------	------	----	----	-----	----	-------	-------	-------	-------	-------	-------	-------	-------	-------	-------

## SATORI WITH TABLET ARM



<b>23202</b>	17 ¼	24 ¾	30 ¾	24 ¼	30 ½	3 ½	50	5,085	5,345	5,530	7,240	7,830	8,060	5,600	6,020	6,355	7,020
--------------	------	------	------	------	------	-----	----	-------	-------	-------	-------	-------	-------	-------	-------	-------	-------

Satori and Satori with Tablet Arm are available as CAL 133 certified for an upcharge of \$550 list per chair. Certification applies to Nienkämper leathers and fabrics that have a minimum of 50% natural fibre content. COM's and COL's are subject to approval. Add the extension -CAL to the model number when ordering.

Model # 23201  
Satori



Model # 23202  
A mesh pocket for storage and interchangeable cup holder.

Model # 23202  
Satori with interchangeable tablet arm accommodates right and left-handed users.



Castors on the Satori chair make it easy to reconfigure meeting space.

### Satori with Tablet Arm

Mesh pocket dimensions are 21" w x 11" h. The tablet arm is made of marine-grade plastic. Legs are cast aluminum.





Specify polished or brushed aluminum finish for tablet holder, cup holder & leg finish.

Handle is in brushed stainless steel finish

# LOUNGE SEATING

Six Collection Designer – Nienkämper

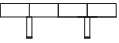
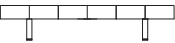
– CND Only –  
KnollTextiles

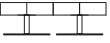
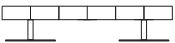



Model Number	Seat H"	Arm H"	W"	D"	H"	Fabric Yds.	Leather Sq. Ft.	COM	COL	Neather	Verde	Grano	Cremoso	1	2	3	4		
<b>LOUNGE CHAIR</b>																			
	30301	16	23¾	32	28	30½	3	45	3,505	3,665	3,725	4,745	5,070	5,200	3,945	4,300	4,590	5,170	
<b>LOUNGE CHAIR W TABLET</b>																			
	30302	16	23¾	32	28	30½	3	45	4,135	4,345	4,345	5,375	5,700	5,815	4,575	4,930	5,220	5,800	
<b>2 SEAT BENCH</b>																			
	30303	17		55	31½		3	45	4,690	4,870	4,985	6,535	7,010	7,210	5,130	5,490	5,775	6,355	
<b>3 SEAT BENCH</b>																			
	30304	17		82	31½		4½	81	5,250	5,470	5,700	8,015	8,740	9,025	5,915	6,450	6,885	7,745	
<b>OTTOMAN</b>																			
	30305	17		28	27¾		1½	27	3,130	3,255	3,290	4,065	4,300	4,390	3,350	3,530	3,675	3,965	
	30310	17		28	27¾		1½	27	2,350	2,470	2,495	3,270	3,505	3,605	2,570	2,750	2,895	3,185	
<b>2 SEAT BENCH ON PEDESTALS</b>																			
	30308	17		63	31½		3	54	3,895	4,075	4,200	5,735	6,225	6,420	4,335	4,690	4,980	5,555	
<b>3 SEAT BENCH ON PEDESTALS</b>																			
	30309	17		82	31½		4½	81	4,460	4,680	4,910	7,215	7,935	8,225	5,120	5,655	6,090	6,955	
<b>SIX COLLECTION ACCESSORIES</b>																			
Cup	30306																	100	
Cup holder	30307																		105

Six Collection passes CAL 133 certified for an upcharge of \$550 list per chair, \$640 per 2 seat bench, \$830 per 3 seat bench and \$485 per ottoman. Certification applies to Nienkämper leathers and fabrics that have a minimum of 50% natural fibre content. COM's and COL's are subject to approval. Add the extension -CAL to the model number when ordering.

# LOUNGE SEATING

Turnaround® Designer - Nienkämper

— CND Only —

Model Number	Seat H"	Arm H"	W"	D"	H"	Fabric Yds.	Leather Sq. Ft.	COM	COL	Verde	Grano	Cremoso	Knoll Textiles										
													1	2	3	4							
<b>LOUNGE CHAIR WITHOUT ARMS</b>																							
	15401	18¾	25	32	32¼	2½	41								2,670	2,820	4,005	4,460	4,590	3,035	3,335	3,580	4,055
<b>LOUNGE CHAIR WITH ARMS</b>																							
	15402	18¾	25¼	36	32	32¼	3½	50							3,950	4,155	5,575	6,110	6,295	4,465	4,885	5,220	5,890
<b>LOUNGE CHAIR WITH TABLET ARMS</b>																							
	15405	18¾	25¼	36	32	32¼	3	50							5,730	6,010	7,435	7,875	8,075	6,170	6,530	6,815	7,395
<b>OTTOMAN</b>																							
	15403	17½	21½	21½		1¾	30								1,300	1,360	2,335	2,585	2,700	1,545	1,740	1,905	2,220
<b>OPTIONAL OTTOMAN TOP ACCESSORY</b>																							
	15404		22½	22½	1¾		8									875	915						





## Turnaround

- Hardwood/Plywood frame, polyurethane foam and Fortrel.
- The back rest on the Armless chair can swivel 360 degrees around the seat with also turns.
- The back swivels independent of the seat and base.
- The Armchair turns (swivels) on its base.
- The round ottoman turns (swivels) and has an optional leather tray that acts as a cocktail table.
- Tablet Arm is made of marine-grade plastic.

# LOUNGE SEATING

Tuxedo™ Designer – Nienkämper

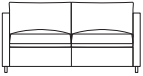
– CND Only –

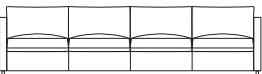
Model Number	Seat H"	Arm H"	W"	D"	H"	Fabric Yds.	Leather Sq. Ft.	COM	COL	Verde	Grano	Cremoso	Knoll Textiles							
													1	2	3	4				
<b>ARMLESS LOUNGE</b>																				
	<b>765</b>	18		25¾	35¾	29	4	65												
<b>LOUNGE</b>																				
	<b>765-1</b>	18	24¾	31¾	35¾	29	7½	92												
<b>TWO SEAT SOFA</b>																				
	<b>765-2</b>	18	24¾	57½	35¾	29	11½	132												
<b>THREE SEAT SOFA</b>																				
	<b>765-3</b>	18	24¾	83¼	35¾	29	16	172												
<b>FOUR SEAT SOFA</b>																				
	<b>765-4</b>	18	24¾	109	35¾	29	20½	212												

**Tuxedo passes CAL 133 certified for an upcharge of \$550 list per chair for armless and arm chair, \$975 list per 2 seat sofa, \$1460 list per 3 seat sofa and \$1945 list per 4 seat sofa. Certification applies to Nienkämper leathers and fabrics that have a minimum of 50% natural fibre content. COM's and COL's are subject to approval. Add the extension -CAL to the model number when ordering.**

This Tuxedo sofa is offered without a welting detail. The armless lounge chair has finished sides.



When upholstered in leather or COM, seat and back cushions are a foam core with a Dacron wrap. Seat and back cushions are loose.

The base is a recessed ebonized runner.

# LOUNGE SEATING

Tuxedo™ Designer – Nienkämper

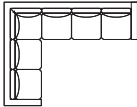
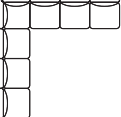
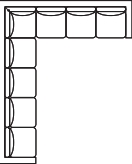
– CND Only –

Model Number	Seat H"	Arm H"	W"	D"	H"	Fabric Yds.	Leather Sq. Ft.	COM	COL	Verde	Grano	Cremoso	Knoll Textiles										
													1	2	3	4							
<b>SIX SEAT L-SHAPED SOFA</b>																							
 <b>765-6</b>	18	24¾	116	90¼	29	32	322								23,620	24,805	42,170	47,030	48,970	28,325	32,125	35,215	41,330
<b>SEVEN SEAT L-SHAPED SOFA</b>																							
 <b>765-7</b>	18	24¾	116	116	29	36	362								26,430	27,770	47,530	53,070	55,285	31,725	35,995	39,470	46,355
<b>EIGHT SEAT L-SHAPED SOFA</b>																							
 <b>765-8</b>	18	24¾	116	141¾	29	40	402								30,135	31,640	53,770	60,000	62,485	36,015	40,765	44,625	52,270
<b>OTTOMAN</b>																							
 <b>765-5</b>			25¾	25¾	17¾	2½	42								2,440	2,575	4,710	5,310	5,560	2,805	3,105	3,345	3,825

This Tuxedo sofa is offered without a welting detail.





When upholstered in leather or COM, seat and back cushions are a foam core with a Dacron wrap. Seat and back cushions are loose.

The base is a recessed ebonized runner.

# LOUNGE SEATING

Tuxedo Classic™ Low Arm Designer – Nienkämper

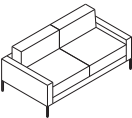
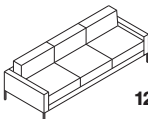
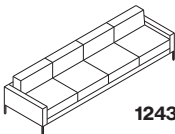
– CND Only –

Model Number	Seat H"	Arm H"	W"	D"	H"	Fabric Yds.	Leather Sq. Ft.	COM	COL	Neather	Verde	Grano	Cremoso	Knoll Textiles			
														1	2	3	4
<b>LOUNGE CHAIR ON LEGS</b>																	
 <b>12431</b>	17	21¾	30½	30½	29¾	4½	72	4,215	4,795	4,425	7,180	7,955	8,290	4,875	5,410	5,845	6,705
<b>LOUNGE CHAIR - SWIVEL BASE</b>																	
 <b>12443</b>	17	21¾	30½	30½	29¾	5½	72	4,040	4,225	4,560	6,870	7,630	7,905	4,850	5,505	6,035	7,085
<b>TWO SEAT SOFA</b>																	
 <b>12432</b>	17	21¾	55	30½	29¾	6	96	6,135	6,430	6,870	10,095	11,130	11,545	7,015	7,730	8,310	9,460
<b>THREE SEAT SOFA</b>																	
 <b>12433</b>	17	21¾	79½	30½	29¾	7½	120	8,065	8,445	8,970	13,000	14,305	14,820	9,170	10,060	10,785	12,220
<b>FOUR SEAT SOFA</b>																	
 <b>12434</b>	17	21¾	104	30½	29¾	9	150	9,800	10,290	10,905	16,000	17,615	18,280	11,120	12,195	13,060	14,780
<b>OTTOMAN</b>																	
 <b>12425</b>	17		25	25	17	2¾	24	1,940	2,045	2,270	2,950	3,200	3,320	2,345	2,675	2,935	3,460

Tuxedo Classic with legs passes CAL 133 certified for an upcharge of \$550 list per chair, \$975 list per two seat sofa, \$1460 list per three seat sofa, \$1945 list per four seat sofa, and \$485 list per ottoman. Certification applies to Nienkämper leathers and fabrics that have a minimum of 50% natural fibre content. COM's and COL's are subject to approval. Add the extension -CAL to the model number when ordering.

Tuxedo Classic is offered without a welting detail. Seat and back cushions have a foam core with Dacron wrap. Back cushions are attached to the frame. Seat cushions are loose.

Square tubular legs made of aluminum are available in a brushed finish. A polished finish is available for an upcharge of \$170 per chair or sofa.

The swivel disk base is upholstered to match the frame.





Model #12431  
Lounge chair fully upholstered in



# LOUNGE SEATING

Tuxedo Classic™ Low Arm with Tufting Designer – Nienkämper

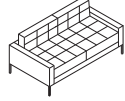
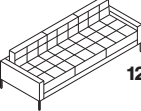
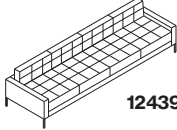
– CND Only –

Model Number	Seat H"	Arm H"	W"	D"	H"	Fabric Yds.	Leather Sq. Ft.	COM	COL	Neather	Verde	Grano	Cremoso	Knoll Textiles			
														1	2	3	4
<b>LOUNGE CHAIR ON LEGS</b>																	
 12436	17	21¾	30½	30½	29¾	4½	72	4,465	4,685	5,010	7,435	8,210	8,530	5,125	5,660	6,100	6,960
<b>LOUNGE CHAIR - SWIVEL BASE</b>																	
 12444	17	21¾	30½	30½	29¾	5½	72	4,275	4,475	4,795	7,125	7,860	8,140	5,085	5,740	6,270	7,320
<b>TWO SEAT SOFA</b>																	
 12437	17	21¾	55	30½	29¾	6	96	6,570	6,905	7,325	10,535	11,575	12,000	7,450	8,165	8,745	9,895
<b>THREE SEAT SOFA</b>																	
 12438	17	21¾	79½	30½	29¾	7½	120	8,680	9,115	9,625	13,640	14,940	15,470	9,785	10,675	11,400	12,835
<b>FOUR SEAT SOFA</b>																	
 12439	17	21¾	104	30½	29¾	9	150	10,635	11,165	11,745	16,830	18,450	19,105	11,955	13,030	13,895	15,615
<b>OTTOMAN</b>																	
 12430	17		25	25	17	2¾	24	2,125	2,230	2,440	3,100	3,360	3,475	2,530	2,860	3,120	3,645

Tuxedo Classic with legs passes CAL 133 certified for an upcharge of \$550 list per chair, \$975 list per two seat sofa, \$1460 list per three seat sofa, \$1945 list per four seat sofa, and \$485 list per ottoman. Certification applies to Nienkämper leathers and fabrics that have a minimum of 50% natural fibre content. COM's and COL's are subject to approval. Add the extension -CAL to the model number when ordering.

Tuxedo Classic with tufting is offered with a welting detail on seat and back cushions. Seat and back cushions have a foam core with Dacron wrap. Back cushions are attached to the frame. Seat cushions are loose.





Square tubular legs made of aluminum are available in a brushed finish. A polished finish is available for an upcharge of \$170 per chair or sofa.

The swivel disk base is upholstered to match the frame.

# LOUNGE SEATING

Tuxedo Classic™ High Arm Designer – Nienkämper

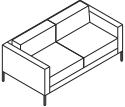
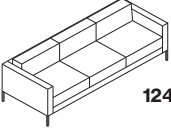
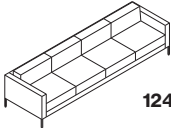
– CND Only –

Model Number	Seat H"	Arm H"	W"	D"	H"	Fabric Yds.	Leather Sq. Ft.	COM	COL	Neather	Verde	Grano	Cremoso	Knoll Textiles				
														1	2	3	4	
<b>LOUNGE CHAIR ON LEGS</b>																		
	12421	17	28	30½	30½	29¾	4½	72	4,315	4,535	4,870	7,280	8,080	8,375	4,975	5,510	5,945	6,805
<b>LOUNGE CHAIR - SWIVEL BASE</b>																		
	12441	17	28	30½	30½	29¾	4½	72	4,125	4,340	4,670	6,985	7,715	8,045	4,930	5,590	6,120	7,170
<b>TWO SEAT SOFA</b>																		
	12422	17	28	55	30½	29¾	6	96	6,240	6,550	6,980	10,280	11,230	11,570	7,120	7,835	8,415	9,565
<b>THREE SEAT SOFA</b>																		
	12423	17	28	79½	30½	29¾	7½	120	8,160	8,570	9,090	13,105	14,425	14,935	9,265	10,155	10,880	12,315
<b>FOUR SEAT SOFA</b>																		
	12424	17	28	104	30½	29¾	9	150	9,910	10,405	11,020	16,095	17,730	18,385	11,230	12,305	13,170	14,890
<b>OTTOMAN</b>																		
	12425	17		25	25	17	2¾	24	1,940	2,045	2,270	2,950	3,200	3,320	2,345	2,675	2,935	3,460

Tuxedo Classic passes CAL 133 certified for an upcharge of \$550 list per chair, \$975 list per two seat sofa, \$1460 list per three seat sofa, \$1945 list per four seat sofa, and \$485 list per ottoman. Certification applies to Nienkämper leathers and fabrics that have a minimum of 50% natural fibre content. COM's and COL's are subject to approval. Add the extension -CAL to the model number when ordering.

Model #12421  
Lounge chair fully upholstered in leather



Tuxedo Classic is offered without a welting detail. Seat and back cushions have a foam core with Dacron wrap. Back cushions are attached to the frame. Seat cushions are loose.





Square tubular legs made of aluminum are available in a brushed finish. A polished finish is available for an upcharge of \$170 per chair or sofa.

The swivel disk base is upholstered to match the frame.

# LOUNGE SEATING

Tuxedo Classic™ High Arm with Tufting Designer – Nienkämper

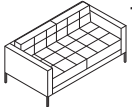
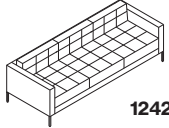
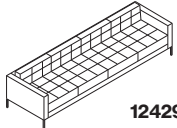
– CND Only –

Model Number	Seat H"	Arm H"	W"	D"	H"	Fabric Yds.	Leather Sq. Ft.	COM	COL	Neather	Verde	Grano	Cremoso	Knoll Textiles			
														1	2	3	4
<b>LOUNGE CHAIR ON LEGS</b>																	
 <b>12426</b>	17	28	30½	30½	29¾	4½	72	4,570	4,795	5,125	7,570	8,330	8,630	5,230	5,765	6,205	7,065
<b>LOUNGE CHAIR - SWIVEL BASE</b>																	
 <b>12442</b>	17	28	30½	30½	29¾	5½	72	4,455	4,585	4,905	7,215	7,955	8,270	5,265	5,920	6,450	7,500
<b>TWO SEAT SOFA</b>																	
 <b>12427</b>	17	28	55	30½	29¾	6	96	6,690	7,020	7,415	10,640	11,690	12,110	7,575	8,285	8,865	10,015
<b>THREE SEAT SOFA</b>																	
 <b>12428</b>	17	28	79½	30½	29¾	7½	120	8,800	9,225	9,720	13,750	15,045	15,590	9,905	10,795	11,520	12,955
<b>FOUR SEAT SOFA</b>																	
 <b>12429</b>	17	28	104	30½	29¾	9	150	10,745	11,270	11,855	16,935	18,560	19,210	12,065	13,140	14,005	15,725
<b>OTTOMAN</b>																	
 <b>12430</b>	17		25	25	17	2¾	24	2,125	2,230	2,440	3,100	3,360	3,475	3,445	4,515	5,385	7,105

Tuxedo Classic passes CAL 133 certified for an upcharge of \$550 list per chair, \$975 list per two seat sofa, \$1460 list per three seat sofa, \$1945 list per four seat sofa, and \$485 list per ottoman. Certification applies to Nienkämper leathers and fabrics that have a minimum of 50% natural fibre content. COM's and COL's are subject to approval. Add the extension -CAL to the model number when ordering.

Tuxedo Classic with tufting is offered with a welting detail on seat and back cushions. Seat and back cushions have a foam core with Dacron wrap. Back cushions are attached to the frame. Seat cushions are loose.

Square tubular legs made of aluminum are available in a brushed finish. A polished finish is available for an upcharge of \$170 per chair or sofa.

The swivel disk base is upholstered to match the frame.

**Model #12426**  
Lounge chair



**Model #12427**  
Two seat sofa



**Model #12427**  
Two seat sofa



**Model #12428**  
Three seat sofa



# LOUNGE SEATING

Tuxedo™ Cove Designer – Nienkämper

– CND Only –

Model Number	Seat H"	Arm H"	W"	D"	H"	Fabric Yds.	Leather Sq. Ft.	COM	COL	Verde	Grano	Cremoso	Knoll Textiles			
													1	2	3	4

## TUXEDO™ COVE THREE SEAT SOFA LEFT

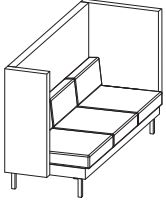

<b>12449</b>	17	46	79¼	31	46	12	216							
COM Frame						8¼	149							
COM Seat & Back Cushion						4½	81							

11,085	11,635	16,640	18,570	19,235	12,850	14,275	15,430	17,725
--------	--------	--------	--------	--------	--------	--------	--------	--------

## TUXEDO™ COVE THREE SEAT SOFA RIGHT

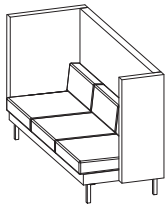

<b>12450</b>	17	46	79¼	31	46	12	216							
COM Frame						8¼	149							
COM Seat & Back Cushion						4½	81							

11,085	11,635	16,640	18,570	19,235	12,850	14,275	15,430	17,725
--------	--------	--------	--------	--------	--------	--------	--------	--------

## INTERCONNECTING PANEL

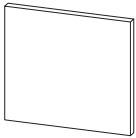

<b>12451</b>			44	3	38¾	2¾	50							
--------------	--	--	----	---	-----	----	----	--	--	--	--	--	--	--

2,590	2,720	4,245	4,545	4,685	2,995	3,325	3,590	4,115
-------	-------	-------	-------	-------	-------	-------	-------	-------

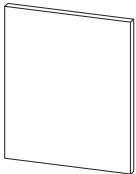

<b>12452</b>			44	3	46	3½	63							
--------------	--	--	----	---	----	----	----	--	--	--	--	--	--	--

3,130	3,290	5,215	5,580	5,765	3,645	4,065	4,400	5,070
-------	-------	-------	-------	-------	-------	-------	-------	-------

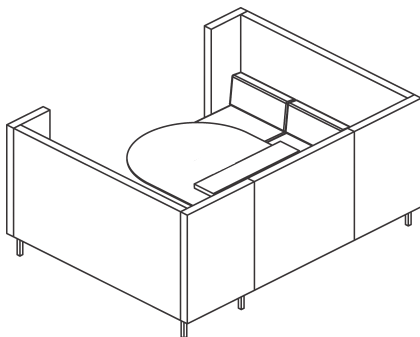

Tuxedo™ Cove Sofa with interconnecting panel  
Model # 12451

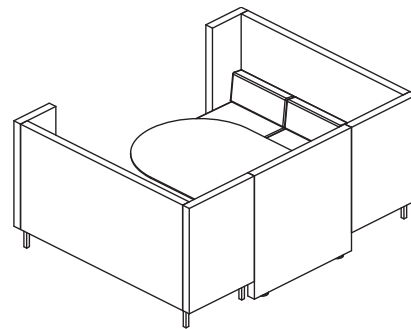

Tuxedo™ Cove Sofa with interconnecting panel  
Model # 12452  
panel with integrated cavity for wire management

## LOUNGE SEATING

Tuxedo™ Cove & Gateway™ Media Lift/Wall Mounted Table Designer – Nienkämper & Busk + Hertzog

Tuxedo™ Cove is composed of two 3 seat high back sofas with an interconnecting panel and table to form an enclosed booth for meetings, collaborative tasks or to be used as a touchdown base for the day. The high sides and back provide total seclusion from the surrounding environment without the need for interior substructures while additional privacy is maintained via the acoustic benefits of the interconnecting panel and the sofas high walls.

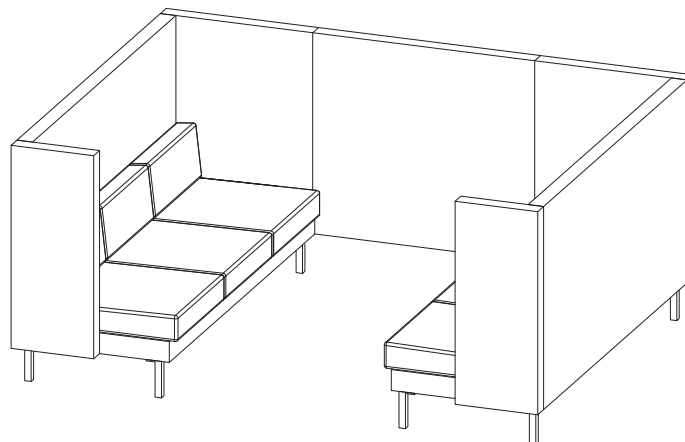

# LOUNGE SEATING

Tuxedo™ Cove & Gateway™ Media Lift Table Designer – Nienkämper & Busk + Hertzog

Table options for Tuxedo™ Cove include the Gateway™ tables, with a full range of connectivity. The Gateway™ Media Lift Table with Relaxed Work Height (26" H) provides a free standing solution while the Gateway™ Wall Mounted Table with Relaxed Work Height (26" H) offers another option for television screen and monitor to be mounted on the interconnecting panel.

Gateway™ Media Lift Table effortlessly transforms meeting tables to create innovative multimedia solutions for communication, presentations and interactive work spaces. At the touch of the remote control, the unit raises the monitor screen up from the base cabinet. The ultimate in professional appearance, Gateway™ Media Lift combines sophistication and function to create additional space, protect your TV from damage or to hide it away from sight.

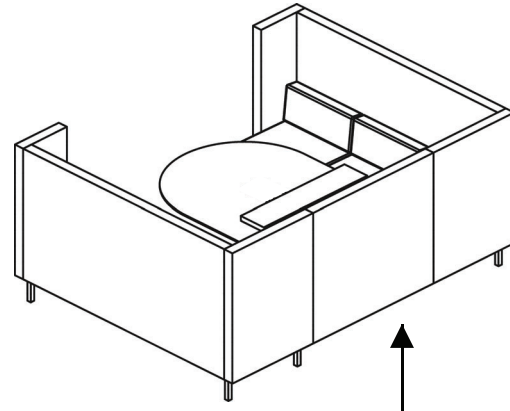

interconnecting panel: 39" h  
Model # 12451

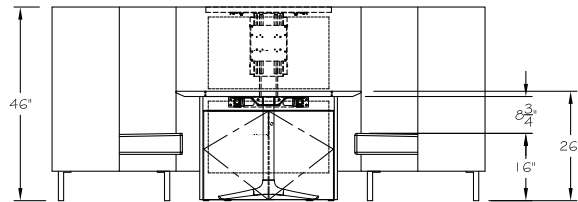
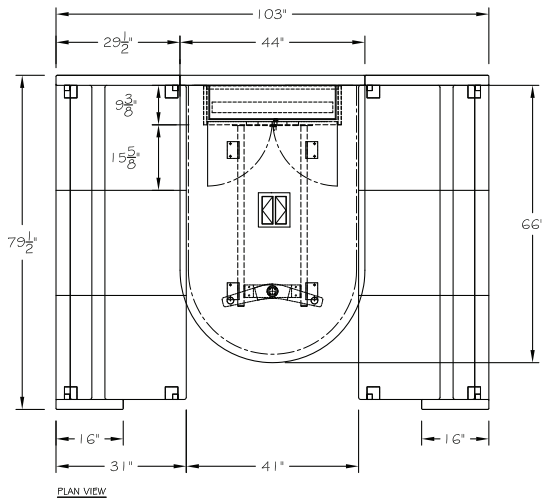

Model #	Description	Quantity	List Price
12449	Tuxedo™ Cove Three Seat Sofa Left in COM	1	11,085
12450	Tuxedo™ Cove Three Seat Sofa Right in COM	1	11,085
12451	Interconnecting Panel (39" H) in COM	1	2,590
43031/5	Gateway Media Lift Table – Relaxed Work Height 26" H in Standard P-lam	1	14,205
85209	Simple Double Sided PopUp Forum Each side with two power & two open ports	1	1,375
<b>Total List:</b>			<b>40,340</b>

**Note:**

- Gateway™ Media Lift Table Dimension 66" L x 44" D x 26" H.
- For standard veneer finish, model #43031/2, list price is \$15,485.
- TV lift can accommodate a maximum TV size of 32".
- TV lift is included. TV is not included.

# LOUNGE SEATING

Tuxedo™ Cove & Gateway™ Wall Mounted Table Designer – Nienkämper & Busk + Hertzog

Gateway™ Wall Mounted Table provides a simple solution by mounting a TV or monitor screen directly onto the interconnecting panel. The wall mounted Gateway™ table with single base provides maximum knee space for users.

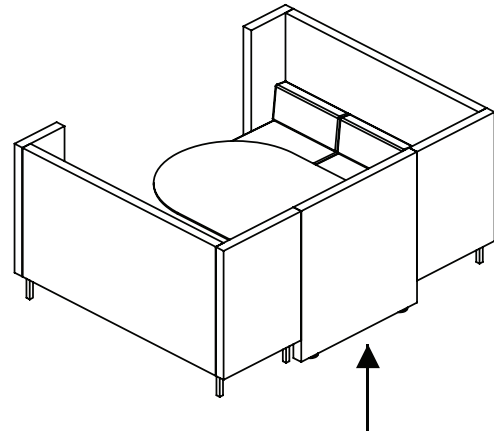
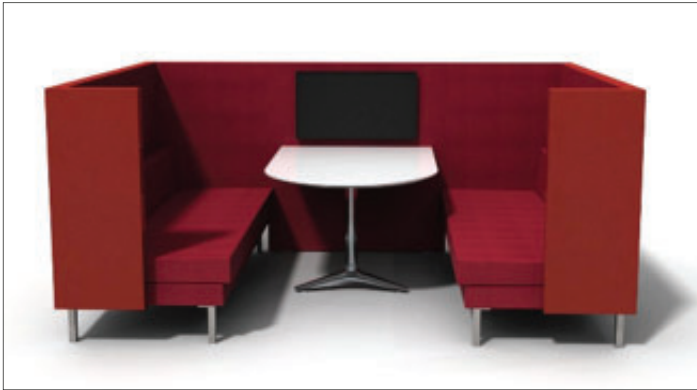

interconnecting panel: 46" h  
Model # 12452

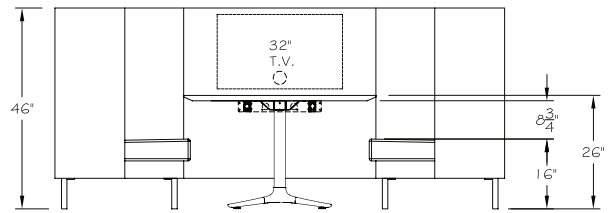
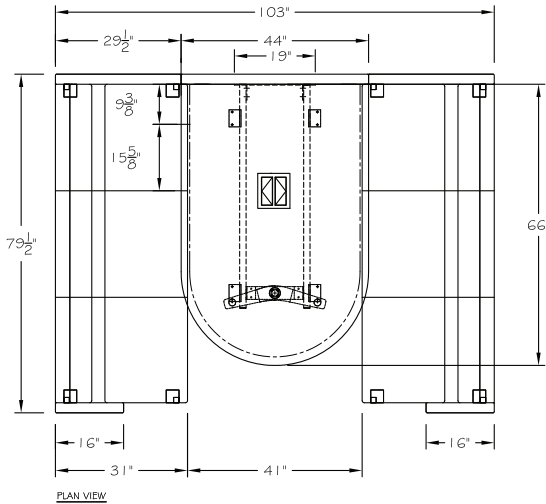

Model #	Description	Quantity	List Price
12449	Tuxedo™ Cove Three Seat Sofa Left in COM	1	11,085
12450	Tuxedo™ Cove Three Seat Sofa Right in COM	1	11,085
12452	Interconnecting Panel (46" H) in COM	1	3,130
43041/5	Gateway Wall Mounted Table – Relaxed Work Height 26" H in Standard P-lam	1	7,325
85209	Simple Double Sided PopUp Forum Each side with two power & two open ports	1	1,375
<b>Total List:</b>			<b>34,000</b>

**Note:**

- Gateway Wall Mounted Table Dimension 66" L x 44" D x 26" H.
- For standard veneer finish, model # 43041/2, list price is \$8,595.
- Maximum TV size to be mounted on panel is 32".
- TV & TV mount are not included.

# LOUNGE SEATING

Tuxedo™ High Back Designer – Nienkämper

– CND Only –

Model Number	Seat Arm			D"	H"	Fabric Leather		COM	COL	Verde	Grano	Cremoso	Knoll Textiles			
	H"	H"	W"			Yds.	Sq. Ft.						1	2	3	4

## TWO SEAT SOFA



<b>12445</b>	17	46	55	31	46	9¼	167	8,730	9,165	13,590	15,195	15,730	10,090	11,190	12,085	13,845
COM Frame						6¾	112									
COM Seat & Back Cushion						3	54									

## LARGE TWO SEAT SOFA



<b>12447</b>	17	46	64	31	46	11¼	203	10,145	10,640	15,805	17,680	18,315	11,800	13,140	14,225	16,370
COM Frame						7½	135									
COM Seat & Back Cushion						3¾	68									

## THREE SEAT SOFA

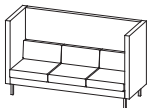

<b>12446</b>	17	46	79½	31	46	12½	225	11,665	12,250	17,595	19,580	20,235	13,500	14,985	16,195	18,580
COM Frame						8¾	157									
COM Seat & Back Cushion						4½	81									

Tuxedo™ High Back passes CAL 133 certified for an upcharge of \$975 list per two seat sofa and \$1460 list per three seat sofa. Certification applies to Nienkämper leathers and fabrics that have a minimum of 50% natural fibre content. COM's and COL's are subject to approval. Add the extension -CAL to the model number when ordering.

Model # 12446  
Tuxedo High Back 3 Seat Sofa



# LOUNGE SEATING

Tuxedo™ High Back Designer – Nienkämper

– CND Only –

Model Number	Seat Arm			D"	H"	Fabric Yds.	Leather Sq. Ft.	COM	COL	Verde	Grano	Cremoso	Knoll Textiles			
	H"	H"	W"										1	2	3	4

## HIGH BACK LOUNGE CHAIR

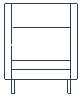

<b>12448</b>	17	46	37¼	31	46	8	144	6,550	7,640	10,940	11,565	11,875	7,725	8,675	9,445	10,980
COM Frame						6½	117									
COM Seat & Back Cushion						2	36									

## ACCESSORIES

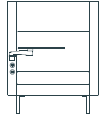

Lounge chair with tablet & power

## ARM SIDE CUSHION

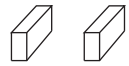

<b>12460</b>		19	3	7	¾	14	945	995	1,420	1,505	1,545	1,060	1,145	1,220	1,365
--------------	--	----	---	---	---	----	-----	-----	-------	-------	-------	-------	-------	-------	-------

Note: Dimension is for one piece. List price & yardage is for a set of two pieces

## TABLET

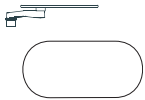

<b>12461</b>		20	12	½			1,665								
--------------	--	----	----	---	--	--	-------	--	--	--	--	--	--	--	--

## Features:

**Cushion:** Seat and back cushions have a foam core with Dacron wrap. Back cushions are attached to the frame. Seat cushions are loose.

**Legs:** Square tubular legs made of cast aluminum are available in a brushed finish. A polished finish is available for an upcharge of \$170 list per chair or sofa.

**Tablet:** Fingerprint resistance solid ½" thick material top, color available in pure white or black, with silver or white powder coat arm support.

**Power:** Standard in white or black finish with 72" cords.

## Vox Simple Dot Forums



White receptacle, model #11867/W \$315 list



White stacked USB, model #11868/W \$545 list



Black receptacle, model #11967/B \$315 list



Black stacked USB, model # 11868/B \$545 list



2 Port, power & USB charger white, model #11866W \$1,030 list



2 Port, power & USB charger black, model #11866/B \$1,030 list

**Model # 12448**  
Tuxedo High Back Lounge Chair upholstered in Verde leather / Graphite VE 6008 with arm side cushion, tablet & power

**Model # 12448**



# LOUNGE SEATING

Wavelength® Designer - Karim Rashid

– CND Only –

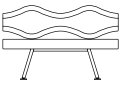
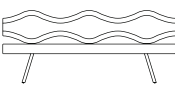
Model Number	Seat H"	W"	D"	H"	Fabric/Leather		COM	COL	Verde	Grano	Cremoso	Knoll Textiles						
					Yds.	Sq. Ft.						1	2	3	4			
<b>CHAIR</b>																		
 <b>1401_</b>	16¾	23¾	31	30¾														
<b>(Model #1)</b>	Fully upholstered				1½	24	4,000	4,200	4,985	5,260	5,370	4,220	4,395	4,545	4,830			
<b>(Model #2)</b>	Fabric seat & back, fabric contrasting trim				¾	¾	4,000					4,220	4,395	4,545	4,830			
<b>(Model #3)</b>	Leather seat & back, leather contrasting trim				12	12		4,200	4,985	5,260	5,370							
<b>TWO SEAT SOFA</b>																		
 <b>1402_</b>	16¾	47¼	31	30¾														
<b>(Model #1)</b>	Fully upholstered				3	48	4,720	4,965	6,715	7,225	7,440	5,165	5,520	5,810	6,385			
<b>(Model #2)</b>	Fabric seat & back, fabric contrasting trim				1½	1½	4,720					5,165	5,520	5,810	6,385			
<b>(Model #3)</b>	Leather seat & back, leather contrasting trim				24	24		4,965	6,715	7,225	7,440							
<b>THREE SEAT SOFA</b>																		
 <b>1403_</b>	16¾	70¾	31	33														
<b>(Model #1)</b>	Fully upholstered				4½	72	5,480	5,745	8,445	9,225	9,545	6,140	6,675	7,110	7,970			
<b>(Model #2)</b>	Fabric seat & back, fabric contrasting trim				2¼	2¼	5,480					6,140	6,675	7,110	7,970			
<b>(Model #3)</b>	Leather seat & back, leather contrasting trim				36	36		5,745	8,445	9,225	9,545							

Wavelength passes CAL 133 certified for an upcharge of \$550 list per chair, \$975 list per 2 seat sofa and \$1,460 list per 3 seat sofa. Certification applies to Nienkämper leathers and fabrics that have a minimum of 50% natural fibre content. COM's and COL's are subject to approval. Add the extension -CAL to the model number when ordering.

Fabric direction when railroaded

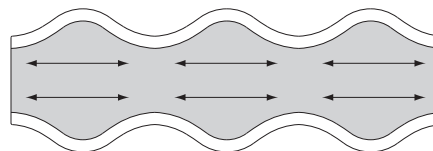

Fabric yardages are based on plain fabrics with no apparent pattern direction. Fabric is railroaded.

When upholstering in two different fabrics or leathers use the COM price or COL price and ship yardages or square footage as noted on page 7. Most fabrics and vinyl are suitable for the top seat portion but the contrasting trim must have stretch.

Nienkämper reserves the right to determine the suitability of COM on our furniture. For further details regarding approvals, refer to page 7.

Specify polished or brushed aluminum frame

Fabric to be upholstered on Wavelength requires approval from Nienkämper's factory. Please contact customer service at 800 668 9318 for our fabric approval list.

**Model #14012**  
Contrasting trim,  
polished aluminum  
frame



**Model #14032**  
Contrasting trim,  
polished aluminum  
frame



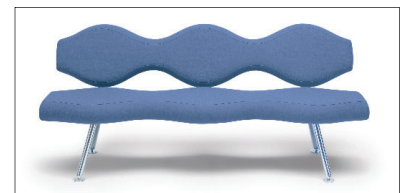

**Model #14031**  
Fully upholstered,  
polished aluminum frame



# LOUNGE SEATING

Wavelength® Designer - Karim Rashid

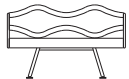
— CND Only —

Model Number	Seat H"	W"	D"	H"	Fabric		COM	COL	Verde	Grano	Cremoso	Knoll Textiles						
					Yds.	Sq. Ft.						1	2	3	4			
<b>CHAIR WITH ARM</b>																		
	1401_	16 3/4	23 5/8	31	30 3/4													
	(Model #7)	Fully Upholstered				1 1/2	24	5,995	6,300	6,985	7,240	7,370	6,215	6,390	6,540	6,825		
	(Model #8)	Fabric seat & back, fabric contrasting trim				3/4	3/4	6,010					6,215	6,390	6,540	6,825		
	(Model #9)	Leather seat & back, leather contrasting trim				12	12		6,300	6,985	7,240	7,370						
<b>TWO SEAT SOFA WITH ARM</b>																		
	1402_	16 3/4	47 1/4	31	30 3/4													
	(Model #7)	Fully Upholstered				3	48	6,740	7,055	8,705	9,215	9,440	7,180	7,535	7,825	8,400		
	(Model #8)	Fabric seat & back, fabric contrasting trim				1 1/2	1 1/2	6,740					7,180	7,535	7,825	8,400		
	(Model #9)	Leather seat & back, leather contrasting trim				24	24		7,055	8,705	9,215	9,440						
<b>THREE SEAT SOFA WITH ARM</b>																		
	1403_	16 3/4	70 5/8	31	33													
	(Model #7)	Fully Upholstered				4 1/2	72	7,480	7,860	10,450	11,225	11,545	8,140	8,675	9,110	9,970		
	(Model #8)	Fabric seat & back, fabric contrasting trim				2 1/4	2 1/4	7,480					8,140	8,675	9,110	9,970		
	(Model #9)	Leather seat & back, leather contrasting trim				36	36		7,860	10,450	11,225	11,545						

Wavelength passes CAL 133 certified for an upcharge of \$550 list per chair, \$975 list per 2 seat sofa and \$1,460 list per 3 seat sofa. Certification applies to Nienkämper leathers and fabrics that have a minimum of 50% natural fibre content. COM's and COL's are subject to approval. Add the extension -CAL to the model number when ordering.

**Fabric direction when railroaded**

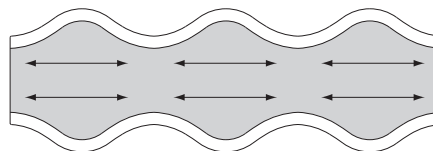

Fabric yardages are based on plain fabrics with no apparent pattern direction. Fabric is railroaded.

When upholstering in two different fabrics or leathers use the COM price or COL price and ship yardages or square footage as noted on page 7. Most fabrics and vinyl are suitable for the top seat portion but the contrasting trim must have stretch.

Nienkämper reserves the right to determine the suitability of COM on our furniture. For further details regarding approvals, refer to page 7.

Specify polished or brushed aluminum frame

Fabric to be upholstered on Wavelength requires approval from Nienkämper's factory. Please contact customer service at 800 668 9318 for our fabric approval list.

**Model #14037**  
Polished aluminum frame and arms

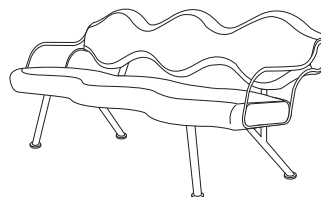

Arms with table on both sides available at an upcharge of \$720 each or \$1440 a pair

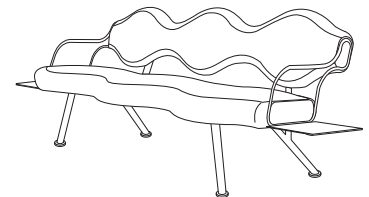

# nienkämpfer

## SEATING & MEETING PODS

### STOOLS & BENCHES



2026

# STOOLS AND BENCHES

## TABLE OF CONTENTS



---

<b>Stools and Benches</b>	<b>84-95</b>
Blottoman™	86
Caravite	87
Jackal	88
Kloud® Benches	89
Mint	90
Moment Collection	91
Six® Collection Benches	92
Spin Stool/Tables	93
Wavelength® Benches	94
Zoo Stools	95

# STOOLS AND BENCHES

Blottoman™ Benches Designer - Karim Rashid

– CND Only –

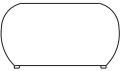
Model Number	Seat H"	W"	D"	H"	Fabric		Leather				Knoll Textiles						
					Yds.	Sq. Ft.	COM	COL	Verde	Grano	Cremoso	1	2	3	4		
<b>BLOTTOMAN</b>																	
	14902 Fully Upholstered	14	18	18	14	1 1/3	23	870	905	1,605	1,810	1,890	1,070	1,225	1,350	1,610	
	14906 Contrasting fabric			Seat		1/2		870					1,070	1,225	1,350	1,610	
	14907 Contrasting leather			Sides			1/2		905	1,605	1,810	1,890					
				Seat		9											
				Sides			9										
<b>BLOTTOMAN SQUARE BENCH</b>																	
	14911 Fully Upholstered	17 1/2	24	24	17 1/2	1 1/3	23	1,390	1,465	2,345	2,585	2,700	1,590	1,745	1,870	2,130	
	14912 Contrasting fabric			Seat		2/3		1,390					1,590	1,745	1,870	2,130	
	14913 Contrasting leather			Sides			2/3		1,465	2,345	2,585	2,700					
				Seat		10											
				Sides			13										
<b>BLOTTOMAN TWO SEAT BENCH</b>																	
	14914 Fully Upholstered	17 1/2	48	24	17 1/2	2 1/3	35	2,410	2,535	3,845	4,225	4,370	2,760	3,030	3,255	3,705	
	14915 Contrasting fabric			Seat		1 2/3		2,410					2,760	3,030	3,255	3,705	
	14916 Contrasting leather			Sides			2/3		2,535	3,845	4,225	4,370					
				Seat		22											
				Sides			13										
<b>BLOTTOMAN LARGE SQUARE BENCH</b>																	
	14917 Fully Upholstered	17 1/2	34	34	17 1/2	1 2/3	30	2,160	2,265	3,400	3,730	3,850	2,405	2,600	2,765	3,080	
	14918 Contrasting fabric			Seat		1 2/3		2,160					2,405	2,600	2,765	3,080	
	14919 Contrasting leather			Sides			2/3		2,265	3,400	3,730	3,850					
				Seat		16											
				Sides			14										

Blottoman passes CAL 133 certified for an upcharge of \$485 list per square bench; two seat bench \$760 list; large square bench \$585 list; blottoman \$385 list. Certification applies to Nienkämper leathers and fabrics that have a minimum of 50% natural fibre content. COM's and COL's are subject to approval. Add the extension "-CAL" to the model number when ordering.

The curvaceous shape and soft molded foam of the Blottoman are conducive to fabrics with some stretch and minimum pattern.

When upholstered in two different fabrics or leathers, use the COM price and ship your fabric yardage or leather square footage to Nienkämper. See page 7 for COM and COL details.

Seams can have matching or contrasting stitching. Matching or contrasting welting detail can also be specified.

\*For patterned or directional fabrics please contact Customer Service at 800.668.9318 for yardages.

Right: Model #14912  
Left: Model # 14918  
Shown with a Virso occasional table,  
Model # 32020T1

Model #14915



# STOOLS AND BENCHES

Caravite Designer - Busk + Hertzog

– CND Only –

Model Number	Seat H"	W"	D"	H"	Fabric		COM	COL	Neather	Verde	Grano	Cremoso	Knoll Textiles			
					Yds.	Sq. Ft.							1	2	3	4

## CARAVITE STOOL



10221	31 3/4	18	14	31 3/4	3/4	14	1,150	1,205	1,225	1,605	1,670	1,710	1,260	1,350	1,425	1,570
-------	--------	----	----	--------	-----	----	-------	-------	-------	-------	-------	-------	-------	-------	-------	-------

## CARAVITE BENCH



10222	16 1/2	47 3/4	35 3/4	16 1/2	2 1/2	41	1,915	2,015	2,140	3,160	3,380	3,480	2,280	2,580	2,820	3,300
-------	--------	--------	--------	--------	-------	----	-------	-------	-------	-------	-------	-------	-------	-------	-------	-------

Model # 10222 & 10221



### Standard Features:

- Distinctive contoured seat cushion with polyurethane foam and plywood frame
- Top stitch detail is standard and contrasting stitching can also be specified.
- Tubular steel frame standard with black powder coat finish, other powder coat colors are available upon request.

# STOOLS AND BENCHES

Jackal Stool Designer - Fig40

Model Number	W"	D"	H"	List Price
<b>JACKAL STOOL</b>				
10226	20¼	19½	37 ⅞	1,670



Model # 10226  
Jackal Stool





**Standard Features:**

- Seat Material: stripy Beech 3D veneer
- Frame Material: stainless steel rod
- Seat Finish: standard stain & finish
- Frame Finish: brushed stainless, powder coat satin black

# STOOLS AND BENCHES

Kloud® Benches Designer - Karim Rashid

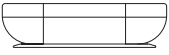
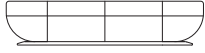
– CND Only –

Model Number	Seat H"	W"	D"	Fabric		COM	COL	Verde	Grano	Cremoso	Knoll Textiles				
				Yds.	Sq. Ft.						1	2	3	4	
<b>TWO SEAT BENCH</b>															
	<b>14998</b>	16	48	30	3	56	3,110	3,265	4,820	5,530	5,730	3,550	3,910	4,195	4,775
	Fully upholstered														
	<b>14977</b>	Contrasting Fabric			1½		3,110					3,550	3,910	4,195	4,775
		Top/seat													
		Bottom			1½										
	<b>14978</b>	Contrasting Leather					3,265	4,820	5,530	5,730					
		Top/seat			27										
		Bottom				27									
<b>TWO SEAT LARGE BENCH</b>															
	<b>14953</b>	16	60	30	3½	62	4,045	4,240	5,930	6,730	6,930	4,560	4,980	5,315	5,980
	Fully upholstered														
	<b>14951</b>	Contrasting Fabric			1¾		4,045					4,560	4,980	5,315	5,980
		Top/seat													
		Bottom			2										
	<b>14952</b>	Contrasting Leather					4,240	5,930	6,730	6,930					
		Top/seat			32										
		Bottom				36									
<b>THREE SEAT BENCH</b>															
	<b>14999</b>	16	72	30	4	72	5,295	5,560	7,490	8,390	8,655	5,880	6,360	6,745	7,510
	Fully upholstered														
	<b>14979</b>	Contrasting Fabric			2		5,295					5,880	6,360	6,745	7,510
		Top/seat													
		Bottom			2½										
	<b>14980</b>	Contrasting Leather					5,560	7,490	8,390	8,655					
		Top/seat			36										
		Bottom				42									
<b>OTTOMAN</b>															
	<b>14990</b>	16	30	30	2½	45	2,140	2,250	3,505	4,075	4,245	2,505	2,805	3,045	3,525
	Fully upholstered														
	<b>14961</b>	Contrasting Fabric			1½		2,140					2,505	2,805	3,045	3,525
		Top/seat													
		Bottom			1¼										
	<b>14962</b>	Contrasting Leather					2,250	3,505	4,075	4,245					
		Top/seat			24										
		Bottom				23									

Fabric to be upholstered on Kloud requires approval from Nienkämper's factory. Please contact customer service at 800 668 9318 for our fabric approval list.

# STOOLS AND BENCHES

Mint Designer - Busk + Hertzog

– CND Only –

Model Number	Seat H"	W"	D"	H"		Fabric Yds.	Leather Sq. Ft.	COM	COL	Neather	Verde	Grano	Cremoso	Knoll Textiles			
														1	2	3	4

## MINT STOOL



10780	16½	26¼	23¾	16½	2	36									1,875	1,970	2,080	3,005	3,200	3,300	2,170	2,410	2,600	2,985
-------	-----	-----	-----	-----	---	----	--	--	--	--	--	--	--	--	-------	-------	-------	-------	-------	-------	-------	-------	-------	-------

Model # 10780



**Standard Features:**

- Frame is constructed of plywood core
- Stool with molded foam

# STOOLS AND BENCHES

Moment collection Designer - Busk + Hertzog

– CND Only –

Model Number	W"	D"	H"	Fabric Yds	Leather Sq. Ft.	COM	COL	Verde	Grano	Cremoso	Knoll Textiles			
											1	2	3	4

## MOMENT STOOLS

19½" top	26011	19½ dia.	16	2	36	1,555	1,635	2,635	2,855	2,965	1,850	2,090	2,280	2,665
----------	-------	----------	----	---	----	-------	-------	-------	-------	-------	-------	-------	-------	-------



16½" top	26012	16½ dia.	16	2	36	1,555	1,635	2,635	2,855	2,965	1,850	2,090	2,280	2,665
----------	-------	----------	----	---	----	-------	-------	-------	-------	-------	-------	-------	-------	-------

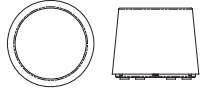

## MOMENT TABLES

19½" top	26021/2	19½ dia.	16	Veneer	2,015
	26021/5			P-Lam	1,325
	26021/7			Paint	1,495

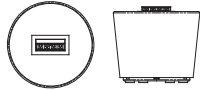

16½" top	26022/2	16½ dia.	16	Veneer	2,015
	26022/5			P-Lam	1,325
	26022/7			Paint	1,495



\*List price for tables doesn't include power unit.

## SIMPLE POP UP FORUM

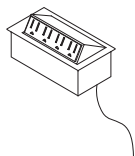

8174	1,080
(4 power pre-wired with 72" cord)	



Linking device detail

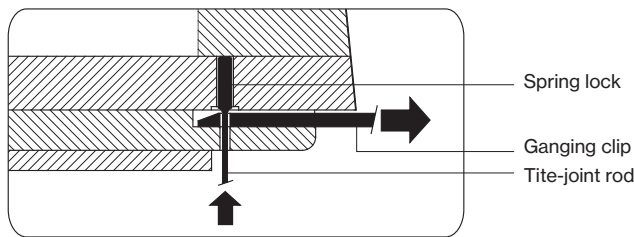





### Standard Features:

- Frame is constructed of plywood core
- Stool constructed with molded foam
- Tables are offered with white, silver, black paint options or any standard wood veneer
- Non-marring glides

# STOOLS AND BENCHES

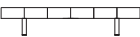
Six® Collection Designer - Nienkämper

– CND Only –

Model Number	Seat H"	W"	D"	H"	Fabric Yds.	Leather Sq. Ft.	COM	COL	Neather	Verde	Grano	Cremoso	Knoll Textiles				
													1	2	3	4	
<b>2 SEAT BENCH</b>																	
 <b>30303</b>	17	63	31½	3	54	4,690	4,870	4,985	6,535	7,010	7,210	5,130	5,490	5,775	6,355		
<b>3 SEAT BENCH</b>																	
 <b>30304</b>	17	82	31½	4½	81	5,250	5,470	5,700	8,015	8,740	9,025	5,915	6,450	6,885	7,745		
<b>OTTOMAN</b>																	
 <b>30305</b>	17	28	27¾	1½	27	3,130	3,255	3,290	4,065	4,300	4,390	3,350	3,530	3,675	3,965		
<b>OTTOMAN ON PEDESTALS</b>																	
 <b>30310</b>	17	28	27¾	1½	27	2,350	2,470	2,495	3,270	3,505	3,605	2,570	2,750	2,895	3,185		
<b>2 SEAT BENCH ON PEDESTALS</b>																	
 <b>30308</b>	17	63	31½	3	54	3,895	4,075	4,200	5,735	6,225	6,420	4,335	4,690	4,980	5,555		
<b>3 SEAT BENCH ON PEDESTALS</b>																	
 <b>30309</b>	17	82	31½	4½	81	4,460	4,680	4,910	7,215	7,935	8,225	5,120	5,655	6,090	6,955		



Six Bench passes CAL 133 certified for an upcharge of \$760 per 2 seat bench, \$930 per 3 seat bench and \$485 per ottoman. Certification applies to Nienkämper leathers and fabrics that have a minimum of 50% natural fibre content. COM's and COL's are subject to approval. Add the extension "-CAL" to the model number when ordering.



# STOOLS AND BENCHES

Wavelength® Benches Designer - Karim Rashid

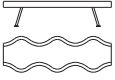
– CND Only –

Model Number	Seat H"	W"	D"	H"	Fabric Yds.	Leather Sq. Ft.	Knoll Textiles												
							COM	COL	Verde	Grano	Cremoso	1	2	3	4				
<b>TWO SEAT BENCH</b>																			
	1404_	16¾	47¼	23½	16¾														
	(Model #1)	Fully Upholstered				1½	24	4,360	4,575	5,345	5,615	5,715	4,580	4,760	4,905	5,195			
	(Model #2)	Fabric seat, fabric contrasting trim				¾	1½	4,360					4,580	4,760	4,905	5,195			
	(Model #3)	Leather seat, leather contrasting trim				12	24		4,575	5,345	5,615	5,715							
	(Model #4)	Fully Upholstered, rounded ends				1¾	28	4,360	4,575	5,345	5,615	5,715	4,615	4,825	4,995	5,330			
	(Model #5)	Fabric seat, fabric contrasting trim, rounded ends				1½	1¾	4,360					4,615	4,825	4,995	5,330			
	(Model #6)	Leather seat, leather contrasting trim, rounded ends				24	28		4,575	5,345	5,615	5,715							
<b>THREE SEAT BENCH</b>																			
	1405_	16¾	70 7/8	23½	16¾														
	(Model #1)	Fully Upholstered				2¼	36	4,820	5,060	6,170	6,535	6,690	5,155	5,420	5,640	6,070			
	(Model #2)	Fabric seat, fabric contrasting trim				2¼	2¼	4,820					5,155	5,420	5,640	6,070			
	(Model #3)	Leather seat, leather contrasting trim				36	36		5,060	5,345	5,615	5,715							
	(Model #4)	Fully Upholstered, rounded ends				2½	40	4,820	5,060	6,170	6,535	6,690	5,190	5,490	5,730	6,210			
	(Model #5)	Fabric seat, fabric contrasting trim, rounded ends				2	2¼	4,820					5,190	5,490	5,730	6,210			
	(Model #6)	Leather seat, leather contrasting trim, rounded ends				32	36		5,060	6,170	6,535	6,690							
<b>OTTOMAN</b>																			
	1406_	16¾	23¾	23½	16¾														
	(Model #1)	Fully Upholstered				1	16	3,495	3,690	3,955	4,070	4,115	3,640	3,760	3,855	4,050			
	(Model #2)	Fabric seat, fabric contrasting trim				¾	½	3,495					3,640	3,760	3,855	4,050			
	(Model #3)	Leather seat, leather contrasting trim				12	8		3,690	3,955	4,070	4,115							

Wavelength Bench passes CAL 133 certified for an upcharge of \$760 list per 2 seat bench, \$930 list per 3 seat bench, \$485 list per ottoman. Certification applies to Nienkämper leathers and fabrics that have a minimum of 50% natural fibre content. COM's and COL's are subject to approval. Add the extension "-CAL" to the model number when ordering.

### Wavelength Benches:

- Fabric yardages are based on plain fabrics with no apparent pattern direction. Fabric is railroaded.
- When upholstering in two different fabrics or leathers use the COM price or COL price and ship yardages or square footage as noted on page 7. Most fabrics and vinyl are suitable for the top seat portion but the contrasting trim must have stretch.
- Nienkämper reserves the right to determine the suitability of COM on our furniture. For further details regarding approvals, refer to page 7.
- Specify polished or brushed aluminum frame.

Fabric to be upholstered on Wavelength requires approval from Nienkämper's factory. Please contact customer service at 800 668 9318 for our fabric approval list.

Fabric direction when railroaded

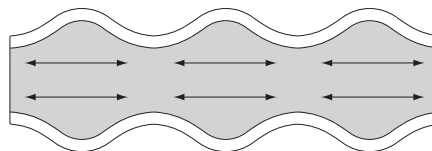

Model #14041  
Cast aluminum frame in polished aluminum



Model #14044  
Two seat bench, polished aluminum frame





Model #14044  
Two seat bench, rounded ends polished aluminum frame



# STOOLS AND BENCHES

ZooStool Designer - Mouna & Silvio Russo

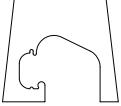
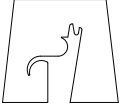
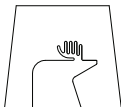
– CND Only –

	Model Number	W"	D"	H"	List Price
<b>BISON STOOL</b>					
	20912	11	11	13¼	995
<b>CAT STOOL</b>					
	20911	11	11	13¼	995
<b>DEER STOOL</b>					
	20914	11	11	13¼	995
<b>MAPLE LEAF STOOL</b>					
	20915	11	11	13¼	995
<b>SEAL STOOL</b>					
	20913	11	11	13¼	995

Stackable Zoo Stools are constructed from plywood core with laminate in bold primary colors:

- Cat: yellow (Arborite Daffodil S480-CA)
- Bison: blue (Abet 482SEI)
- Seal: green (Abet 460SEI)
- Deer: orange (Pionite bittersweet S0312)
- Maple Leaf: red (Wilsonart Holly Berry D307-60)

Note: Custom colors and logos available for quantities of 4+

# nienkämpfer

## SEATING & MEETING PODS

### MEETING PODS



2026

# MEETING PODS

Patkau Ice Hut Designer - Patkau Architects

Model Number	W"	D"	H"	Fabric Leather		COM	COL	Verde	Grano	Cremoso	- CND Only -			
				Yds.	Sq. Ft.						Knoll	Textiles	1	2

## PATKAU ICE HUT

<b>21000</b>	60	60	96	9	162	75,195	78,965	84,975	86,585	88,190	76,455	77,475	78,300	79,940
--------------	----	----	----	---	-----	--------	--------	--------	--------	--------	--------	--------	--------	--------



Model # 21000



# MEETING PODS

Toko Designer - Carl Gustav Magnusson

## TOKO - SMALL FOOT PRINT

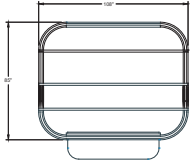

Model Number	W"	D"	H"	List Price
Small Foot Print	85	108	94	*Due to the level of customization offered with Toko meeting pods, pricing must be provided by Nienkämper customer service. This ensures your unique build requirements are met to 100% accuracy and satisfaction.  Please contact customer service for more details at 800.668.9318
Medium Foot Print	118	108	94	
Large Foot Print	151	108	94	

## TOKO - MEDIUM FOOT PRINT

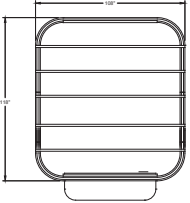

## TOKO - LARGE FOOT PRINT

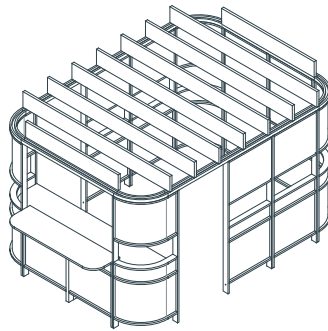
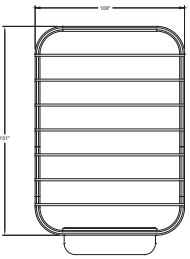

### TOKO Meeting Pod - Large Foot Print model

Shown with low sheen solid walnut construction, natural walnut perforated panels, (RL-04) finger print resistant laminate bar top and stone counter top.



### Standard Features:

- Modular, solid wood frame construction.
- Choice of 4 insert panel materials and a variety of finish options.
- Serving Counters are available in all standard Nienkämper laminates and Caesar Stone materials.
- Storage drawers and undercounter doored cases with adjustable shelves.
- Integrated refrigerator and concealed waste receptacle options
- Concealed and counter top power
- Integrated lighting available upon request with upcharge
- Contact Nienkämper customer service for more information and details at 800.668.9318

ADA complaint counter with wheelchair leg space, box drawer, two drawer storage with integrated finger pulls and single drawer fridge shown

