

nienkämpfer

VOX[®] CONFERENCE

LCS BASE TABLES



2026

Prices shown are List Prices, FOB our Toronto
Factory- freight charges are extra. Packing and/
or crating is available, if required, upcharges apply.

HOW TO ORDER VOX® CONFERENCE TABLES

Vox® Conference Tables- Designed for versatility and style, Vox tables are available in a wide range of shapes and sizes to complement any meeting space. Standard heights are 28½" or 29", and the collection can be customized to meet unique requirements. For assistance, contact your local Nienkämper Sales Representative or Customer Service at **800.668.9318**.

SELECT SHAPE



Use the table of contents, or simply flip through the Conference Tables section of the Planning Guide to select a table shape that is suitable. To help find a shape, a small outline of the top is provided in the upper corner of each page.

SELECT BASE OPTION

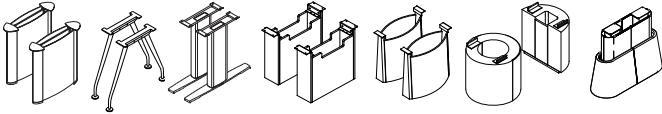

There are seven distinct base designs for each table shape that offer both aesthetic and functional benefits. Each base design is listed by model number for every top shape with options and choices for base finishes. For the Duo, Tri, Quad, Access, Tower and Drum Bases, a wood or plastic laminate finish must be selected, see page 8-11. If not specified otherwise, base finish will match top finish. Pages 17-23 illustrates the features of each base in detail and describes how wiring is accommodated.

SELECT SIZE AND MODEL NUMBER

L" x D"	Suggested Seating Capacity*	Top Finish	Top Sections	Model Number
120 x 42	8 - 10		2	51309/

Select the table size, from as small as 72" x 36" to as large as 240" x 84". Seating capacity is listed and can aid in determining the size required. Select a wood veneer or wood laminate option for your top.

SELECT EDGE PROFILE

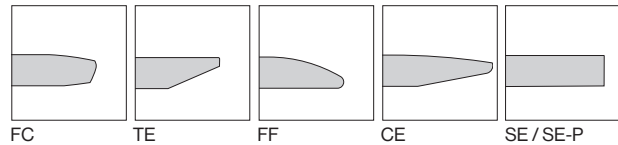

Edge profiles can be specified for nearly any table shape. A small profile drawing appears at the top of each page, along with a two- or three-letter code indicating which edge profiles pair best with each top. Add this code to the end of the model number when specifying. For profile photos and scaled drawings, refer to page 13

SELECT VENEER AND FINISH

If a wood veneer top was chosen, a species and finish must be selected. Page 8 describes all wood veneer options.

SELECT LAMINATE

If a laminate top is preferred, Nienkämper offers a variety of wood grain and solid color laminates to choose from. Refer to pages 9-11 for a complete listing as well as instructions for customer specified laminates. Wood edges on wood grain laminate tops are selected to most closely resemble both the species and color of the laminate. Facet and Taper edge profiles are available with laminate tops.

ALUMINUM FINISH

Aluminum finishes must be specified for T-Base, Duo style bases, Access Base trim (if applicable), Forums and Accessories.

SELECT FORUMS (POWER / CONNECTIVITY SOLUTION)



Vox® Forums provide a large variety of options for simple to complex connectivity requirements. Pages 216-245 describe these products and their features. Pages 219-221 show Vox Forum placement along the table top for all sizes of tops. Anodized aluminum finishes are listed on page 12.

Power Troughs or Power Drawers can be added to most Vox® Conference Tables providing a full range of Connectivity and Power solutions. Details can be found on pages 246-263.



For further information on Forums, Power Edge, Power Trough and Power Drawer please contact Customer Service at **800.668.9318**.

SELECT ACCESSORIES

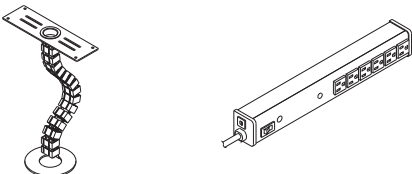

A range of accessories can be specified that will enhance the performance of your Vox® Conference table. All products that relate to wire management can be found on pages 264-277. Accessories, such as table pads and coasters, are also in this section.

veneers

All wood surfaces are protected with a durable polyurethane clear lacquer with UV inhibitor. This finish is known for its exceptional durability, as well as abrasion, chemical, impact and scratch resistance. Standard sheen level is 45 degrees. Optional matte, 5, 10 and 35 degree sheen levels are available on request at no additional cost.

Wood Species	Order Code	Veneer/Stain	Upcharge
Maple	F-01	Natural Maple	No upcharge applies.
	F-02	Natural Curly Maple - Rotary Cut	Add 15%.
	F-03	Natural Bird's Eye Maple - Rotary Cut	Call Customer Service for pricing.
	F-04	Maple Stained Pear	No upcharge applies.
Cherry	F-05	Natural Cherry	No upcharge applies.
	F-06	Standard Cherry	No upcharge applies.
	F-07	Cherry Stained Amber	No upcharge applies.
	F-08	Cherry Stained Auburn	No upcharge applies.
	F-09	Cherry Stained Burgundy	No upcharge applies.
Mahogany	F-10	Light Mahogany	No upcharge applies.
	F-11	Medium Mahogany	No upcharge applies.
	F-12	Dark Mahogany	No upcharge applies.
	F-13	Red Mahogany	No upcharge applies.
Anagré	F-14	Natural Figured Anagré - Qtr. Cut Book-Match	Add 15%.
	F-15	Figured Anagré Stained Amber - Qtr. Cut Book-Match	Add 15%.
Sycamore	F-16	Natural Figured Sycamore - Qtr. Cut Book-Match	Add 15%.
Walnut	F-17	Burnt Walnut	No upcharge applies.
	F-19	Natural Walnut- Flat Cut Book-Match	No upcharge applies.
	F-19FM	Natural Walnut- Flat Cut Book-Match (matte sheen)	No upcharge applies.
	F-27F	Creamy Walnut- Flat Cut Book-Match (10° sheen)	No upcharge applies.
	F-27R	Creamy Walnut - Rift Cut Slip-Match (10° sheen)	Add 5%
	F-28	Tawny Walnut	No upcharge applies.
	F-31FM	Autumn Walnut- Flat Cut Book-Match (matte sheen)	No upcharge applies.
	F-31RM	Autumn Walnut - Rift Cut Slip-Match (matte sheen)	Add 5%
Oak	F-18F	Natural White Oak - Flat Cut Book-Match (10° sheen)	No upcharge applies.
	F-18R	Natural White Oak - Rift Cut Slip-Match (10° sheen)	Add 5%
	F-26	Charcoal Ash On Oak- Flat Cut Book- Match (10° sheen)	No upcharge applies.
	F-29F	Smoky Oak - Flat Cut Book-Match	No upcharge applies.
	F-29R	Smoky Oak - Rift Cut Slip-Match	Add 5%
	F-29FM	Smoky Oak - Flat Cut Book-Match (matte sheen)	No upcharge applies.
	F-29RM	Smoky Oak - Rift Cut Slip-Match (matte sheen)	Add 5%
	F-30FM	Whisper White Oak - Flat Cut Book-Match (matte sheen)	No upcharge applies.
	F-30RM	Whisper White Oak - Rift Cut Slip-Match (matte sheen)	Add 5%
	F-32FM	Cotton White Oak - Flat Cut Book-Match (matte sheen)	No upcharge applies.
F-32RM	Cotton White Oak - Rift Cut Slip-Match (matte sheen)	Add 5%	
Sapele – Ribbon Stripe	F-20	Natural Ribbon Strip Sapele - Qtr. Cut Slip-Match	No upcharge applies.
Moabi (Cherry substitute)	F-21	Natural Moabi - Quarter - Qtr. Cut Book-Match	No upcharge applies.
Cape Coast Walnut	F-22	Dark Cape Coast Walnut - Qtr. Cut Slip-Match	No upcharge applies.
	F-23	Natural Cape Coast Walnut - Qtr. Cut Slip-Match	No upcharge applies.
	F-23	Natural Cape Coast Walnut - Qtr. Cut Slip-Match	No upcharge applies.
Ash	F-25	Slate Gray Ash - Qtr. Cut Slip-Match	No upcharge applies.

VENEER GRAIN OPTIONS

Nienkämper products utilize the best quality veneers available, and, combined with Nienkämper's patented veneering systems, create work environments of incredible quality and beauty.

All veneer furniture comes standard with flat cut book-match veneer; flat cut slip-match veneer can also be specified. Quarter cut slip-match and quarter cut book-match veneers are available at a 5% upcharge. Figured Anagré and Figured Sycamore veneers are Quarter cut book-matched. Bird's Eye Maple and Curly Maple are rotary cut. Facet Edge, Taper edge, Flowform, Camber and Self edge tops with veneer are manufactured with a solid wood edge. All edges are then veneer wrapped to create a seamless profile top.

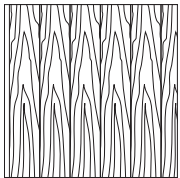

Standard V1
Flat Cut Book-Match

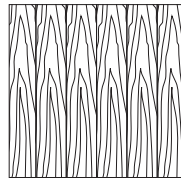

Flat Cut Slip-Match V2

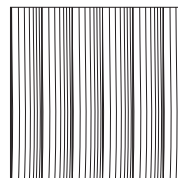

Quarter Cut Slip-Match V3
Add 5%

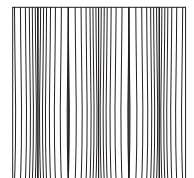

Quarter Cut Book-Match V4
Add 5%

P-LAM

Wood grain plastic laminate surfaces are available on table tops with Facet, Taper and Self edges.

These tops are manufactured with a solid wood edge that is applied prior to the laminate top surface. This method conceals the thickness of the wood edge, while providing the durability required. Wood edges are selected that most closely resemble both the species and the color of the laminate chosen

Nienkämper has pre-selected a number of standard wood grain plastic laminates that represent a cross section of both color and species. Simply include the order code with the model number to make these selections. Alternatively wood grain plastic laminates selected outside of Nienkämper's standard selection can be made by specifying the manufacturer as well as the description and model number of the laminate at the time of order.

Wood Grain Plastic Laminate Surfaces	Order Code	Manufacturer #	Finish
Hardrock Maple	WL2	Pionite WM791-SD	Textured/Suede
Monticello Maple	WL5	Wilsonart 7925-38	Fine Velvet Texture
Fusion Maple	WL13	Wilsonart 7909-60	Matte
New Age Oak	WL14	Wilsonart 7938-38	Fine Velvet Texture
Wild Cherry	WL18	Wilsonart 7054-60	Matte
River Cherry	WL19	Wilsonart 7937-38	Fine Velvet Texture
Montana Walnut	WL20	Wilsonart 7110T-78	Fine Grain
Skyline Walnut	WL26	Wilsonart 7964K-12	Soft Grain
Continental Walnut	WL-29	Wilsonart 8232K-05	Timbergrain
Neo Walnut	WL-30	Wilsonart 7991-38	Fine Velvet Texture
Walnut Heights	WL-31	Wilsonart 7965K-12	Soft Grain
Grayed Oak	WL-32	Formica 5791-PG	Pure Grain Texture
Millennium Oak	WL-33	Formica 5887-58	Matte
Aged Ash	WL-34	Formica 8844-WR	Woodbrush
Lowell Ash	WL-35	Wilsonart 7994-38	Fine Velvet Texture
Natural Ash	WL-36	Formica 8843-WR	Woodbrush
Norwegian Ash	WL-37	Wilsonart 8241-38	Fine Velvet Texture
Weathered Ash	WL-38	Formica 8842-WR	Woodbrush
Smoky Brown Pear	WL-39	Formica 5488-26	Oiled Wood
Studio Teak	WL-40	Wilsonart 7960K-18	Linearity
Fawn Cypress	WL-41	Wilsonart 8208K-16	Casual Rustic
Landmark Wood	WL-42	Wilsonart 7981K-12	Soft Grain
Natural Cerise	WL-43	Formica 8863-58	Matte
Natural Recon	WL-44	Wilsonart 7996-38	Fine Velvet Texture
Pecan Woodline	WL-45	Formica 5883-58	Matte

To specify the wood grain laminate required simply add the Order Code WL_ to the model number of the product.

Samples and specific technical data is available from your local sales representative or by contacting Nienkämper's Customer Service department at **800.668.9318**.

P-LAM

COLORED P-LAM

Both Taper and Self edge profiles are available with a colored laminate top.

Laminate edging on Taper tops. Edging will match the top surface and is applied before the surface laminate. By applying the laminate in this way, the seam is positioned horizontally, which makes it much less conspicuous and more durable.

Wood edging on Self and Taper Edge tops are applied before the laminate. By applying the wood edge in this way, the wood edge thickness is concealed, while providing the durability required. Wood species and finishes for edging can be selected from page 8.

For laminates specified outside of Nienkämper's standard selection, specify the manufacturer as well as the description and model number of the laminate selected at the time of order. For Facet edge tops, the laminate must be a post-forming grade.

Translucent edging on Self and Taper edge tops is applied after the surface laminate. The translucent edge is very durable. Clear translucent edge provides a good match with most white-colored laminates, while a silver translucent edge provides a metallic look and contrast to colored plastic laminates.

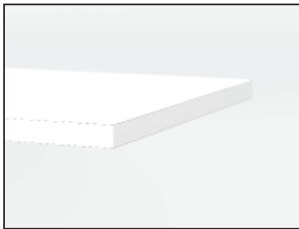

P-Lam top & Self edge

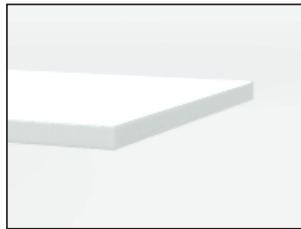

P-Lam top & Translucent Self edge



Wood Grain P-Lam top & silver Translucent Self edge

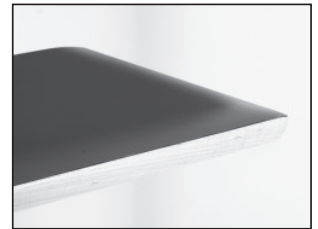

P-Lam top & solid wood Facet edge

*An unavoidable, thin dark line will be visible when specifying a matching p.lam edge. This is more pronounced with light colored laminates

Colored Plastic Laminates Surface	Order Code	Manufacturer #	Finish
Gray (Nienkämper - Light Gray/Putty)	CL-01	Wilsonart 1500-60	Matte
Platinum Gray (Nienkämper - Medium Gray/Clay)	CL-02	Nevamar S6023T	Textured
Slate Grey (Nienkämper - Dark Gray)	CL-03	Wilsonart D91-60	Matte
Black	CL-04	Wilsonart 1595-60	Matte
Angel White	CL-05	Pionite SW-826SD	Textured/ Suede
Frosty White	CL-06	Wilsonart 1573-60	Matte
White (for writable surface)	Contact customer service for details 800.668.9318		Gloss

Add the order code behind the edge profile when specifying.

P-LAM

FINGERPRINT RESISTANT P-LAM

Fingerprint Resistant Plastic Laminate is an innovative material created for interior design applications and is suitable for both vertical and horizontal interior applications on our Nienkämper furniture.

The external surface of Fingerprint Resistant Plastic Laminate involves the use of nanotechnology made possible by next generation acrylic resins.

The unique composition offers extraordinary features coupled with a unique user experience. These include an ultra matte surface (eliminating glare), an ultra soft feel, an anti-fingerprint surface, thermal healing of micro-scratches, increased durability as well as anti-bacterial and mold-resistant properties.

Edgeband matching all Fingerprint Resistant Plastic Laminate colors is only available when specifying a Taper edge. For Self edge tops 1" and 1 1/4" thick, matching edgeband are only available in Black (RL-01) and White (RL-03). When a matching edgeband is not available, the specified surface laminate is used on the edge. **Contact Customer Service for more details 800.668-9318.**

There is a 20% upcharge on our standard plastic laminate table pricing for Fingerprint Resistant Plastic Laminate.

Colored "Fingerprint Resistant" Plastic Laminate Surface	Order Code	Finish
Black	RL-01	Matte
Gray	RL-02	Matte
White	RL-03	Matte
Sand	RL-04	Matte
Brown	RL-05	Matte
Clay	RL-06	Matte
Beige	RL-07	Matte
Ash	RL-08	Matte
Smoke	RL-09	Matte

Edgeband to Match with Colored "Fingerprint Resistant" Plastic Laminate	Thickness	Order Code
Black	3/4", 1", 1-1/4"	RE-01
Gray	3/4"	RE-02
White	3/4", 1", 1-1/4"	RE-03
Sand	3/4"	RE-04
Brown	3/4"	RE-05
Clay	3/4"	RE-06
Beige	3/4"	RE-07
Ash	3/4"	RE-08
Smoke	3/4"	RE-09

ALUMINUM/PAINT FINISHES - VOX®

ALUMINUM FINISHES

Anodized Aluminum Finishes	Order Code
Silver	AL-01
Champagne	AL-02
Light Bronze	AL-03
Bronze	AL-04
Black	AL-06

Simply specify the finish of choice when placing your order. Note upcharges may apply for non-standard finishes. Anodized aluminum and paint finish samples are available from your local sales representative or by calling Nienkämper's Customer Service department, at **800.668.9318**.

PAINT FINISHES

Some Vox® components are painted.

Paint finishes are generally used when anodizing is not an option, (i.e. castings). While color matching is close, it is impossible to match exactly the qualities of anodizing with paint finishes.

Standard Paint	Order Code
Silver	SP-01
Champagne	SP-02
Light Bronze	SP-03
Angel White	SP-04
Frosty White	SP-05
Black	SP-06

Metallic Paint	Order Code
Silver Metallic	MP-01
Champagne Metallic	MP-02
Light Bronze Metallic	MP-03

Powder Coat Paint	Order Code
Nienkämper Silver	PC-01
Champagne	PC-02
Light Bronze	PC-03
Standard Bronze	PC-04
Black Jack	PC-06
Warm White	PC-07
Red	PC-09
Cool White	PC-12
Pure Orange	PC-14
Lime	PC-16
Sky Blue	PC-17
Cobalt Blue	PC-18
Charcoal Gray (Matte)	PC-22
Matte Red Clay	PC-24
Cream	PC-25
Mulberry	PC-26
Forest Green (Matte)	PC-27
Mustard (Matte)	PC-28

EDGE DETAILS - CONFERENCE TABLES

Conference tables with tops that are 1 1/4" thick have 5 edge profiles to choose from.

To select:

Facet Edge add "FC" after the table model number

Taper Edge add "TE" after the table model number

Flowform Edge add "FF" after the table model number

Camber Edge add "CE" after the table model number

Self Edge add "SE" or "SE-P" (exposed plywood edge) after the table model number

Flowform Edge and Camber Edge require a 5% upcharge

Flowform and Camber edged tops are veneer-wrapped, and are not available with plastic laminate

- Rectangle shape, Boat shape, Vista shape and Congress shape tops specified with a Flowform Edge have this edge profile on two sides only, with self edges on the two ends of the top.
- All conference table tops are 1 1/4" thick, edges are manufactured with a profiled solid wood edge.
- Camber edge is standard with an 8" radius corner feature on rectangle, boat, square, and vista shaped tops.

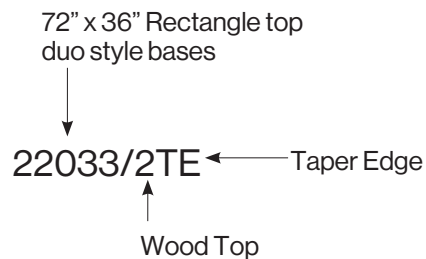

EXAMPLE

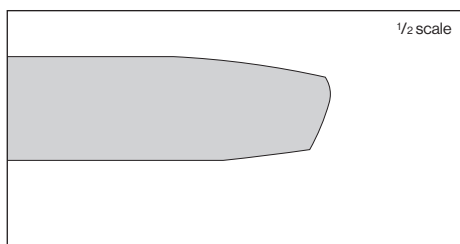

Facet Edge "FC"

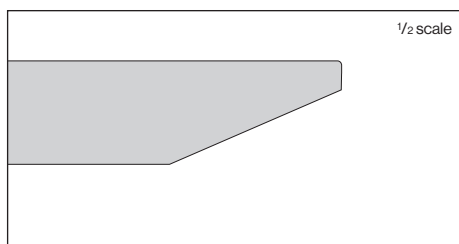

Taper Edge "TE"

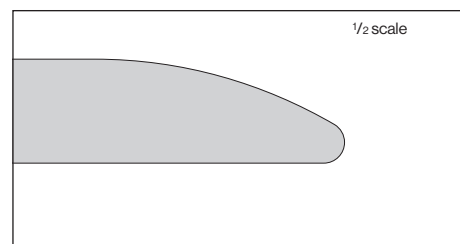

Flowform Edge "FF"

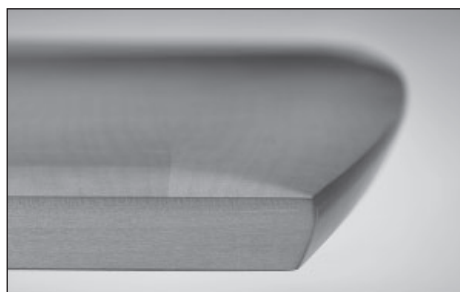

Facet Edge - specify "FC"

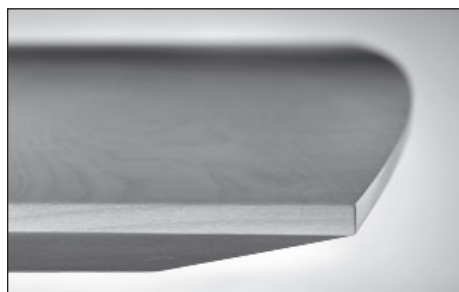

Taper Edge - specify "TE"

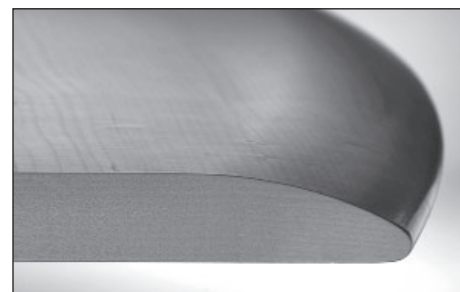

Flowform Edge - specify "FF"

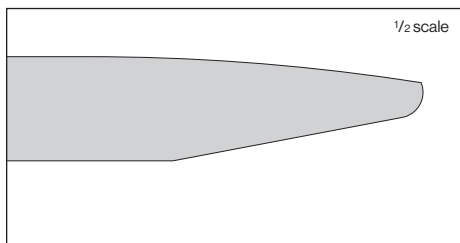

Camber Edge "CE"

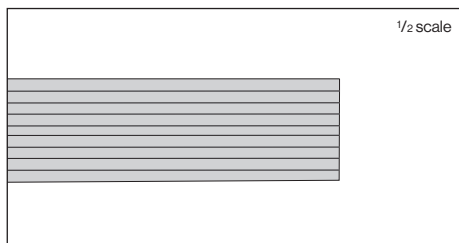

Self Edge "SE" / Self Edge with Exposed Plywood Core "SE-P"

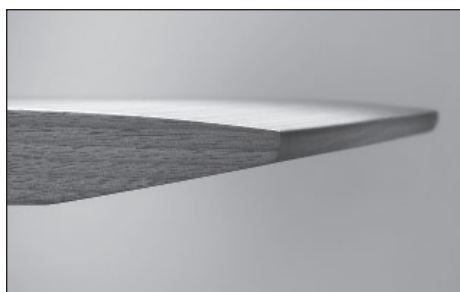

Camber Edge - specify "CE"



Self "SE" / Self with Exposed Plywood Core "SE-P"

SPECIAL TOP OPTIONS – VOX® CONFERENCE TABLES

A range of special top options are available for creating unique tables. By adding reveals, stain and veneer combinations personalizing your Vox® conference table has never been easier. Four examples are shown that can be easily included in any of our standard conference tables. Simply specify the option you prefer and Nienkämper's customer service department (**call 800.668.9318**) can provide you with a quotation based on the model of table selected. They will also be happy to help you if a custom combination of veneer and finishes are required.



Option A
Flat cut, Book-matched veneer, Natural finish, 1/4" polished aluminum reveal.

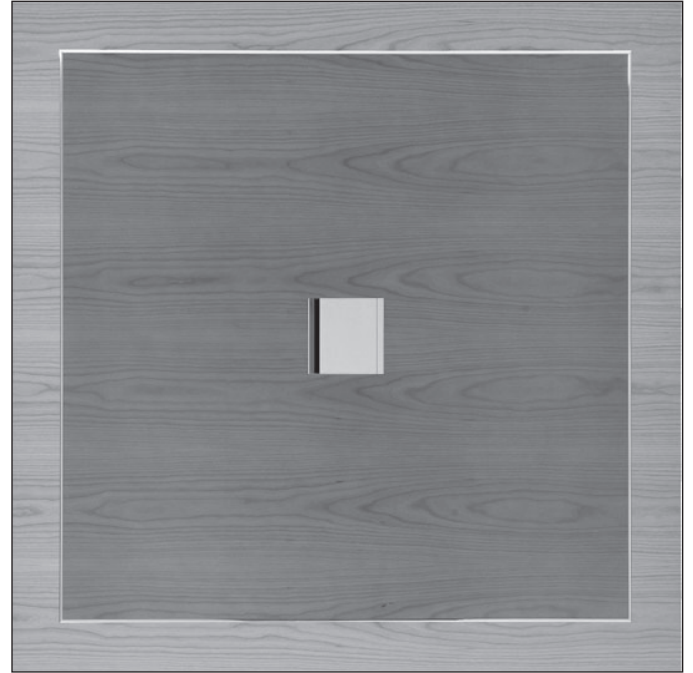

Option B
Flat cut, Book-matched veneer, Natural finish edge, stained center, 1/4" polished aluminum reveal.



Option C
Flat cut, Book-matched veneer (veneer pattern as shown), stained edge, natural finish center, 1/4" polished aluminum reveal.

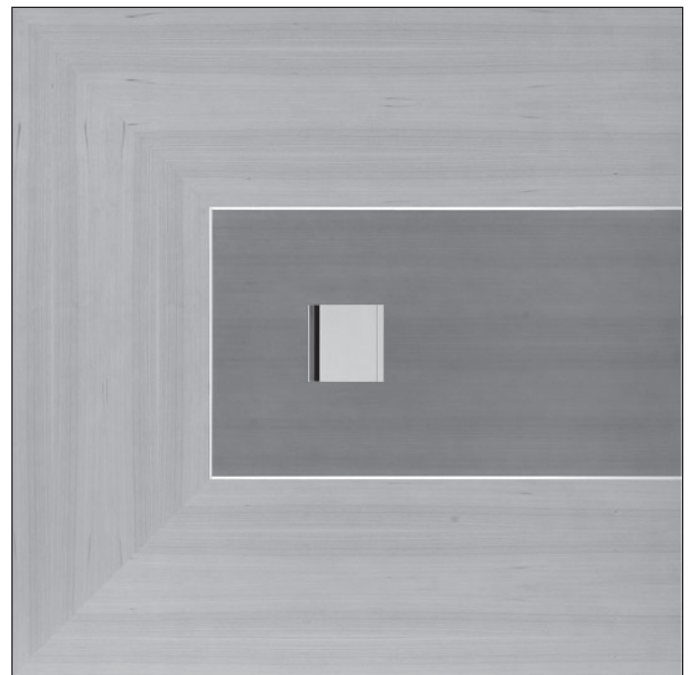

Option D
Rift cut, Book-matched veneer, Natural finish edge, stained center, 1/4" polished aluminum reveal.

BASE STYLE OPTIONS – VOX® CONFERENCE TABLES

Base Designs

Vox® conference tables offer seven distinct base designs, each combining aesthetic appeal with functional benefits. These base options are available for most top shapes and include a variety of finish choices. All bases are listed by model number for easy reference.

To assist with selection, pages 17-23 provide detailed illustrations and descriptions of each base design along with their wiring capacity.



Vox® Duo Base

The Duo, Tri and Quad base provide ample capacity for storing cabling inside the leg. Available in a range of veneers and stains and anodized finishes.



Vox® Access Base

These bases are designed to manage and conceal cabling while hiding core drills and floor-mounted receptacles for a clean, streamlined look. Available in veneer and plastic laminate with or without aluminum trim—select by model number.



Vox® Tower Base

With a distinctive shape, these bases are designed to manage wiring and conceal core drills and floor-mounted receptacles, while providing generous internal space for cable routing. Available in veneer and plastic laminate. Select by model number.



Vox® Drum Base

Available in 2 styles, Half Drum (shown) or Full Drum bases, both designed to provide generous space for tables with extensive cabling and power needs. The wiring and power cavity is easily accessible—remove the straight panel for the Half Drum style or a section of the base for Full Drum models. Available in various veneers, stains and plastic laminates. Selection is based on model number.

BASE OPTIONS – VOX® CONFERENCE TABLES



Vox® T-Leg Base

The vertical section of the T-Leg base features an integrated channel designed to manage excess cabling and route wires to and from the floor. Available in anodized or polished aluminum—selection determined by model number.



Vox® Taper Base

The very thin profile of the Taper base design is ideal for maximizing space under a table. Available in polished aluminum or silver paint – Select by model number.



Vox® LCS Base

The LCS effortlessly transitions from sitting to standing height at the push of a button. Cabling is concealed within the Neather wrapped base. Also available as a fixed height. – Select by model number.

VOX® LCS CONFERENCE BASE INTERIOR CLEARANCES

LCS Conference and Round Base - Available in two fixed heights (29" and 38") and a height-adjustable option (29½"–42"), the LCS collection offers a stylish solution for conference rooms. Race track-shaped bases slide open at the center for easy access to wiring and floor power. Dimensions for floor core drills or flush receptacles are provided. Bases are fully upholstered in black Neather with contrasting stitching. Sit/stand models feature premium-quality powered lifts. Detailed drawings, including base locations, can be downloaded from www.nienkamper.com

Height Adjustable

Table Length"	Base Width"	Base Depth"	Base Height"	Interior Clearance A"	Interior Clearance B"	Openings
96 - 144	48¾"	17 ⅞"	22"	12 ⅝"	3½"	1
156	72¾"	17 ⅞"	22"	12"	10"	1

Fixed Height

96 - 132	48¾"	17 ⅞"	22"	12 ⅝"	3½"	1
144 - 156	68 ⅝"	17 ⅞"	22"	12 ⅝"	3½"	1
168	81 ⅝"	17 ⅞"	22"	12"	10"	1
180	89 ⅝"	17 ⅞"	22"	12"	10"	1
192	106 ⅝"	17 ⅞"	22"	12"	10"	2
204	121 ⅝"	17 ⅞"	22"	12"	10"	2
216	133 ⅝"	17 ⅞"	22"	12"	10"	2
228	145 ⅝"	17 ⅞"	22"	12"	10"	2
240	149 ⅝"	17 ⅞"	22"	12"	10"	2

Description

LCS CONFERENCE - FIXED & HEIGHT ADJUSTABLE BASE PLAN VIEW

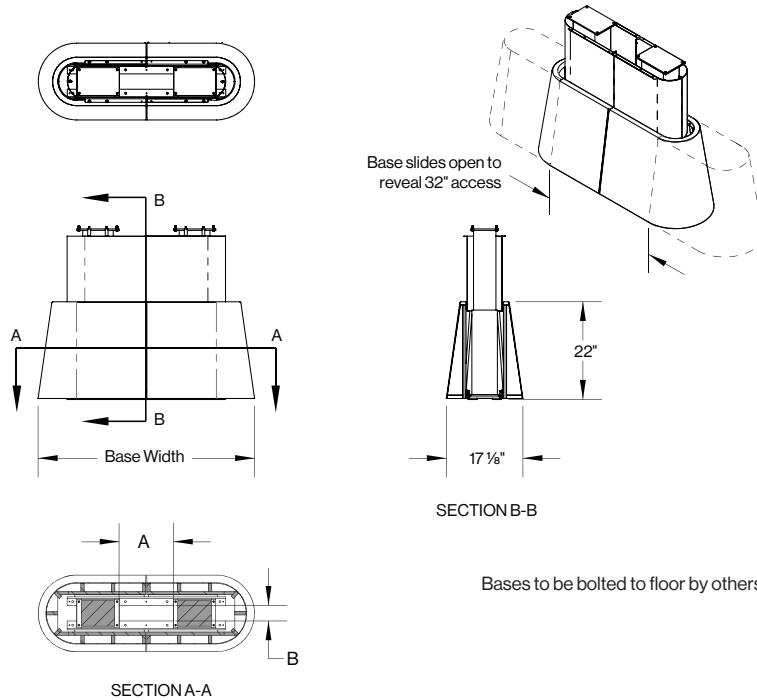

Description

LCS ROUND CONFERENCE - FIXED & HEIGHT ADJUSTABLE PLAN VIEW

Base Diameter"	Base Height"	Interior Clearance A"	Interior Clearance B"
24 ⅝"	24 ¾"	5"	7"

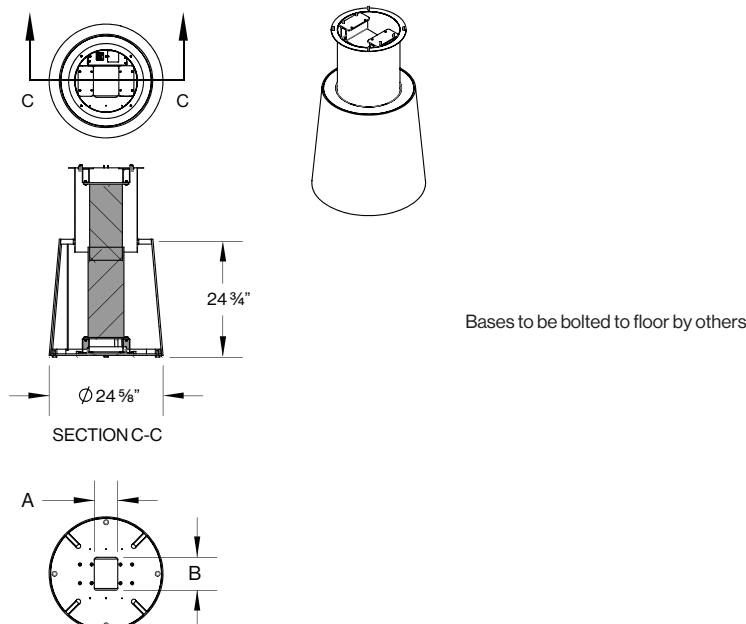

VOX® LCSTABLES

RECTANGLE SHAPE Design Nienkämper , Jeremy Gibson



All Rectangular shape table sizes available with optional 6" radius "Soft" corner (must be specified at time of order)

Specify edge type; add the two letter code after the model number.



Facet Edge (FC)



Taper Edge (TE)



Flowform Edge (FF)
5% upcharge
laminates not available

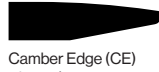

Camber Edge (CE)
5% upcharge
laminates not available

Model Number	W"	D"	H"	Top Finish	List Price	Model Number	W"	D"	H"	Top Finish	List Price	Standard Features:
--------------	----	----	----	------------	------------	--------------	----	----	----	------------	------------	--------------------

Fixed Height (Seating)

34361/230	96	42	29	Veneer	19,050
34361/530	96	42	29	P-Lam	18,055
34362/230	96	48	29	Veneer	19,285
34362/530	96	48	29	P-Lam	18,240
34363/230	96	54	29	Veneer	19,525
34363/530	96	54	29	P-Lam	18,430
34364/230	96	60	29	Veneer	19,785
34364/530	96	60	29	P-Lam	18,635
34365/230	108	42	29	Veneer	19,335
34365/530	108	42	29	P-Lam	18,155
34366/230	108	48	29	Veneer	19,710
34366/530	108	48	29	P-Lam	18,475
34367/230	108	54	29	Veneer	19,840
34367/530	108	54	29	P-Lam	18,525
34368/230	108	60	29	Veneer	20,105
34368/530	108	60	29	P-Lam	18,710
34369/230	120	42	29	Veneer	19,600
34369/530	120	42	29	P-Lam	18,400
34370/230	120	48	29	Veneer	20,085
34370/530	120	48	29	P-Lam	18,635
34371/230	120	54	29	Veneer	20,490
34371/530	120	54	29	P-Lam	18,870
34372/230	120	60	29	Veneer	20,775
34372/530	120	60	29	P-Lam	18,965
34373/230	132	42	29	Veneer	19,975
34373/530	132	42	29	P-Lam	18,635
34374/230	132	48	29	Veneer	20,390
34374/530	132	48	29	P-Lam	18,840
34375/230	132	54	29	Veneer	20,860
34375/530	132	54	29	P-Lam	18,965
34376/230	132	60	29	Veneer	21,100
34376/530	132	60	29	P-Lam	19,135
34377/230	144	42	29	Veneer	20,285
34377/530	144	42	29	P-Lam	18,770
34378/230	144	48	29	Veneer	20,725
34378/530	144	48	29	P-Lam	19,050
34379/230	144	54	29	Veneer	21,250
34379/530	144	54	29	P-Lam	19,265
34380/230	144	60	29	Veneer	21,670
34380/530	144	60	29	P-Lam	19,525
34381/230	156	42	29	Veneer	20,525
34381/530	156	42	29	P-Lam	18,925
34382/230	156	48	29	Veneer	21,035
34382/530	156	48	29	P-Lam	19,285
34383/230	156	54	29	Veneer	21,640
34383/530	156	54	29	P-Lam	19,550
34384/230	156	60	29	Veneer	22,110
34384/530	156	60	29	P-Lam	19,840

Fixed Height (Standing)

34361/238	96	42	38	Veneer	20,620
34361/538	96	42	38	P-Lam	19,620
34362/238	96	48	38	Veneer	20,860
34362/538	96	48	38	P-Lam	19,810
34363/238	96	54	38	Veneer	21,100
34363/538	96	54	38	P-Lam	19,995
34364/238	96	60	38	Veneer	21,355
34364/538	96	60	38	P-Lam	20,205
34365/238	108	42	38	Veneer	20,910
34365/538	108	42	38	P-Lam	19,730
34366/238	108	48	38	Veneer	21,270
34366/538	108	48	38	P-Lam	20,040
34367/238	108	54	38	Veneer	21,410
34367/538	108	54	38	P-Lam	20,105
34368/238	108	60	38	Veneer	21,670
34368/538	108	60	38	P-Lam	20,285
34369/238	120	42	38	Veneer	21,170
34369/538	120	42	38	P-Lam	19,975
34370/238	120	48	38	Veneer	21,640
34370/238	120	48	38	P-Lam	20,205
34371/538	120	54	38	Veneer	22,065
34371/238	120	54	38	P-Lam	20,440
34372/538	120	60	38	Veneer	22,345
34372/238	120	60	38	P-Lam	20,545
34373/538	132	42	38	Veneer	21,550
34373/238	132	42	38	P-Lam	20,205
34374/538	132	48	38	Veneer	21,960
34374/238	132	48	38	P-Lam	20,415
34375/538	132	54	38	Veneer	22,430
34375/238	132	54	38	P-Lam	20,545
34376/538	132	60	38	Veneer	22,660
34376/238	132	60	38	P-Lam	20,705
34377/538	144	42	38	Veneer	21,855
34377/238	144	42	38	P-Lam	20,335
34378/538	144	48	38	Veneer	22,300
34378/238	144	48	38	P-Lam	20,620
34379/538	144	54	38	Veneer	22,820
34379/238	144	54	38	P-Lam	20,830
34380/538	144	60	38	Veneer	23,240
34380/238	144	60	38	P-Lam	21,100
34381/538	156	42	38	Veneer	22,085
34381/238	156	42	38	P-Lam	20,490
34382/538	156	48	38	Veneer	22,615
34382/238	156	48	38	P-Lam	20,860
34383/538	156	54	38	Veneer	23,215
34383/238	156	54	38	P-Lam	21,125
34384/538	156	60	38	Veneer	23,680
34384/238	156	60	38	P-Lam	21,410

- Tops available in all Nienkämper standard veneers, finishes and plastic laminates.
- Black Neather wrapped base with contrasting stitch is standard but all Nienkämper Neathers are also available.
- Shrouds and columns are powder coated black (PC-06).
- Base must be floor mounted on site by others according to acceptable means.
- Wires are concealed by the column and are hidden from view.
- Connectivity solutions include Vox® Double Sided Forum and Vox® Simple PopUp Forum

VOX® LCS TABLES

RECTANGLE SHAPE Design Nienkämper , Jeremy Gibson

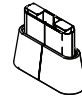

Specify edge type; add the two letter code after the model number.



Facet Edge (FC)



Taper Edge (TE)



Flowform Edge (FF)
5% upcharge
laminates not available



Camber Edge (CE)
5% upcharge
laminates not available

All Rectangular shape table sizes available with optional 6" radius "Soft" corner (must be specified at time of order)

Model Number **W"** **D"** **H"** **Top Finish** **List Price**

Standard Features:

Adjustable Height

34385/23045	96	42	29½-42	Veneer	24,950
34385/53045	96	42	29½-42	P-Lam	23,950
34386/23045	96	48	29½-42	Veneer	25,180
34386/53045	96	48	29½-42	P-Lam	24,130
34387/23045	96	54	29½-42	Veneer	25,410
34387/53045	96	54	29½-42	P-Lam	24,310
34388/23045	96	60	29½-42	Veneer	25,675
34388/53045	96	60	29½-42	P-Lam	24,525
34389/23045	108	42	29½-42	Veneer	25,230
34389/53045	108	42	29½-42	P-Lam	24,055
34390/23045	108	48	29½-42	Veneer	25,600
34390/53045	108	48	29½-42	P-Lam	24,370
34391/23045	108	54	29½-42	Veneer	25,735
34391/53045	108	54	29½-42	P-Lam	24,415
34392/23045	108	60	29½-42	Veneer	25,990
34392/53045	108	60	29½-42	P-Lam	24,605
34393/23045	120	42	29½-42	Veneer	25,495
34393/53045	120	42	29½-42	P-Lam	24,290
34394/23045	120	48	29½-42	Veneer	25,970
34394/53045	120	48	29½-42	P-Lam	24,525
34395/23045	120	54	29½-42	Veneer	26,380
34395/53045	120	54	29½-42	P-Lam	24,755
34396/23045	120	60	29½-42	Veneer	26,665
34396/53045	120	60	29½-42	P-Lam	24,865
34397/23045	132	42	29½-42	Veneer	25,860
34397/53045	132	42	29½-42	P-Lam	24,525
34398/23045	132	48	29½-42	Veneer	26,280
34398/53045	132	48	29½-42	P-Lam	24,735
34399/23045	132	54	29½-42	Veneer	26,745
34399/53045	132	54	29½-42	P-Lam	24,865
34400/23045	132	60	29½-42	Veneer	26,985
34400/53045	132	60	29½-42	P-Lam	25,020
34401/23045	144	42	29½-42	Veneer	26,180
34401/53045	144	42	29½-42	P-Lam	24,655
34402/23045	144	48	29½-42	Veneer	26,615
34402/53045	144	48	29½-42	P-Lam	24,950
34403/23045	144	54	29½-42	Veneer	27,150
34403/53045	144	54	29½-42	P-Lam	25,155
34404/23045	144	60	29½-42	Veneer	27,565
34404/53045	144	60	29½-42	P-Lam	25,410
34405/23045	156	42	29½-42	Veneer	26,415
34405/53045	156	42	29½-42	P-Lam	24,820
34406/23045	156	48	29½-42	Veneer	26,930
34406/53045	156	48	29½-42	P-Lam	25,180
34407/23045	156	54	29½-42	Veneer	27,530
34407/53045	156	54	29½-42	P-Lam	25,440
34408/23045	156	60	29½-42	Veneer	28,005
34408/53045	156	60	29½-42	P-Lam	25,735

- Tops available in all Nienkämper standard veneers, finishes and plastic laminates.
- Black Neather wrapped base with contrasting stitch is standard but all Nienkämper Neathers are also available.
- Shrouds and columns are powder coated black (PC-06).
- Base must be floor mounted on site by others according to acceptable means.
- Wires are concealed by the column and are hidden from view.
- Connectivity solutions include Vox® Double Sided Forum and Vox® Simple PopUp Forum
- Electric, ultra quiet height adjustable system with a variety of touch controls. Contact customer service for details 800.668.9318.



VOX® LCS TABLES

BOAT SHAPE

Design Nienkämper, Jeremy Gibson



All Boat shape table sizes available with optional 6" radius "Soft" corner (must be specified at time of order)



Facet Edge (FC)



Taper Edge (TE)



Flowform Edge (FF)
5% upcharge
laminates not available

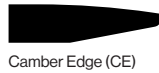

Camber Edge (CE)
5% upcharge
laminates not available

Model Number	W"	D"	H"	Top Finish	List Price	Model Number	W"	D"	H"	Top Finish	List Price	Standard Features:
Fixed Height (Seating)												
34571/230	96	42	29	Veneer	19,810	34571/238	96	42	38	Veneer	21,450	<ul style="list-style-type: none"> • Tops available in all Nienkämper standard veneers, finishes and plastic laminates. • Black Neather wrapped base with contrasting stitch is standard but all Nienkämper Neathers are also available. • Shrouds and columns are powder coated black (PC-06). • Base must be floor mounted on site by others according to acceptable means. • Wires are concealed by the column and are hidden from view. • Connectivity solutions include Vox® Double Sided Forum and Vox® Simple PopUp Forum
34571/530	96	42	29	P-Lam	18,785	34571/538	96	42	38	P-Lam	20,415	
34572/230	96	48	29	Veneer	20,065	34572/238	96	48	38	Veneer	21,695	
34572/530	96	48	29	P-Lam	18,965	34572/538	96	48	38	P-Lam	20,605	
34573/230	96	54	29	Veneer	20,310	34573/238	96	54	38	Veneer	21,940	
34573/530	96	54	29	P-Lam	19,160	34573/538	96	54	38	P-Lam	20,790	
34574/230	96	60	29	Veneer	20,580	34574/238	96	60	38	Veneer	22,210	
34574/530	96	60	29	P-Lam	19,380	34574/538	96	60	38	P-Lam	21,010	
34575/230	108	42	29	Veneer	20,115	34575/238	108	42	38	Veneer	21,750	
34575/530	108	42	29	P-Lam	18,890	34575/538	108	42	38	P-Lam	20,525	
34576/230	108	48	29	Veneer	20,495	34576/238	108	48	38	Veneer	22,125	
34576/530	108	48	29	P-Lam	19,225	34576/538	108	48	38	P-Lam	20,840	
34577/230	108	54	29	Veneer	20,635	34577/238	108	54	38	Veneer	22,270	
34577/530	108	54	29	P-Lam	19,275	34577/538	108	54	38	P-Lam	20,910	
34578/230	108	60	29	Veneer	20,910	34578/238	108	60	38	Veneer	22,535	
34578/530	108	60	29	P-Lam	19,470	34578/538	108	60	38	P-Lam	21,100	
34579/230	120	42	29	Veneer	20,390	34579/238	120	42	38	Veneer	22,025	
34579/530	120	42	29	P-Lam	19,140	34579/538	120	42	38	P-Lam	20,770	
34580/230	120	48	29	Veneer	20,885	34580/238	120	48	38	Veneer	22,515	
34580/530	120	48	29	P-Lam	19,380	34580/538	120	48	38	P-Lam	21,010	
34581/230	120	54	29	Veneer	21,315	34581/238	120	54	38	Veneer	22,945	
34581/530	120	54	29	P-Lam	19,620	34581/538	120	54	38	P-Lam	21,255	
34582/230	120	60	29	Veneer	21,605	34582/238	120	60	38	Veneer	23,245	
34582/530	120	60	29	P-Lam	19,735	34582/538	120	60	38	P-Lam	21,370	
34583/230	132	42	29	Veneer	20,770	34583/238	132	42	38	Veneer	22,410	
34583/530	132	42	29	P-Lam	19,380	34583/538	132	42	38	P-Lam	21,010	
34584/230	132	48	29	Veneer	21,210	34584/238	132	48	38	Veneer	22,840	
34584/530	132	48	29	P-Lam	19,600	34584/538	132	48	38	P-Lam	21,235	
34585/230	132	54	29	Veneer	21,695	34585/238	132	54	38	Veneer	23,330	
34585/530	132	54	29	P-Lam	19,735	34585/538	132	54	38	P-Lam	21,370	
34586/230	132	60	29	Veneer	21,940	34586/238	132	60	38	Veneer	23,565	
34586/530	132	60	29	P-Lam	19,900	34586/538	132	60	38	P-Lam	21,540	
34587/230	144	42	29	Veneer	21,100	34587/238	144	42	38	Veneer	22,730	
34587/530	144	42	29	P-Lam	19,515	34587/538	144	42	38	P-Lam	21,145	
34588/230	144	48	29	Veneer	21,565	34588/238	144	48	38	Veneer	23,195	
34588/530	144	48	29	P-Lam	19,810	34588/538	144	48	38	P-Lam	21,450	
34589/230	144	54	29	Veneer	22,100	34589/238	144	54	38	Veneer	23,730	
34589/530	144	54	29	P-Lam	20,025	34589/538	144	54	38	P-Lam	21,675	
34590/230	144	60	29	Veneer	22,535	34590/238	144	60	38	Veneer	24,170	
34590/530	144	60	29	P-Lam	20,310	34590/538	144	60	38	P-Lam	21,940	
34591/230	156	42	29	Veneer	21,350	34591/238	156	42	38	Veneer	22,975	
34591/530	156	42	29	P-Lam	19,680	34591/538	156	42	38	P-Lam	21,315	
34592/230	156	48	29	Veneer	21,880	34592/238	156	48	38	Veneer	23,520	
34592/530	156	48	29	P-Lam	20,065	34592/538	156	48	38	P-Lam	21,695	
34593/230	156	54	29	Veneer	22,515	34593/238	156	54	38	Veneer	24,140	
34593/530	156	54	29	P-Lam	20,335	34593/538	156	54	38	P-Lam	21,970	
34594/230	156	60	29	Veneer	23,010	34594/238	156	60	38	Veneer	24,630	
34594/530	156	60	29	P-Lam	20,635	34594/538	156	60	38	P-Lam	22,270	

VOX® LCS TABLES

BOAT SHAPE

Design Nienkämper, Jeremy Gibson



Specify edge type; add the two letter code after the model number.

All Boat shape table sizes available with optional 6" radius "Soft" corner (must be specified at time of order)

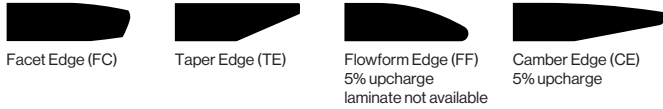

Facet Edge (FC)

Taper Edge (TE)

Flowform Edge (FF)
5% upcharge
laminates not available

Camber Edge (CE)
5% upcharge

Model Number W" D" H" Top Finish List Price

Standard Features:

Adjustable Height

34595/23045	96	42	29½-42	Veneer	25,955
34595/53045	96	42	29½-42	P-Lam	24,910
34596/23045	96	48	29½-42	Veneer	26,190
34596/53045	96	48	29½-42	P-Lam	25,105
34597/23045	96	54	29½-42	Veneer	26,435
34597/53045	96	54	29½-42	P-Lam	25,290
34598/23045	96	60	29½-42	Veneer	26,705
34598/53045	96	60	29½-42	P-Lam	25,510
34599/23045	108	42	29½-42	Veneer	26,240
34599/53045	108	42	29½-42	P-Lam	25,010
34600/23045	108	48	29½-42	Veneer	26,620
34600/53045	108	48	29½-42	P-Lam	25,345
34601/23045	108	54	29½-42	Veneer	26,765
34601/53045	108	54	29½-42	P-Lam	25,395
34602/23045	108	60	29½-42	Veneer	27,035
34602/53045	108	60	29½-42	P-Lam	25,590
34603/23045	120	42	29½-42	Veneer	26,505
34603/53045	120	42	29½-42	P-Lam	25,270
34604/23045	120	48	29½-42	Veneer	27,010
34604/53045	120	48	29½-42	P-Lam	25,510
34605/23045	120	54	29½-42	Veneer	27,435
34605/53045	120	54	29½-42	P-Lam	25,755
34606/23045	120	60	29½-42	Veneer	27,740
34606/53045	120	60	29½-42	P-Lam	25,860
34607/23045	132	42	29½-42	Veneer	26,900
34607/53045	132	42	29½-42	P-Lam	25,510
34608/23045	132	48	29½-42	Veneer	27,325
34608/53045	132	48	29½-42	P-Lam	25,725
34609/23045	132	54	29½-42	Veneer	27,820
34609/53045	132	54	29½-42	P-Lam	25,860
34610/23045	132	60	29½-42	Veneer	28,070
34610/53045	132	60	29½-42	P-Lam	26,015
34611/23045	144	42	29½-42	Veneer	27,225
34611/53045	144	42	29½-42	P-Lam	25,645
34612/23045	144	48	29½-42	Veneer	27,685
34612/53045	144	48	29½-42	P-Lam	25,955
34613/23045	144	54	29½-42	Veneer	28,235
34613/53045	144	54	29½-42	P-Lam	26,165
34614/23045	144	60	29½-42	Veneer	28,665
34614/53045	144	60	29½-42	P-Lam	26,435
34615/23045	156	42	29½-42	Veneer	27,470
34615/53045	156	42	29½-42	P-Lam	25,810
34616/23045	156	48	29½-42	Veneer	28,005
34616/53045	156	48	29½-42	P-Lam	26,190
34617/23045	156	54	29½-42	Veneer	28,635
34617/53045	156	54	29½-42	P-Lam	26,455
34618/23045	156	60	29½-42	Veneer	29,130
34618/53045	156	60	29½-42	P-Lam	26,765

- Tops available in all Nienkämper standard veneers, finishes and plastic laminates.
- Black Neather wrapped base with contrasting stitch is standard but all Nienkämper Neathers are also available.
- Shrouds and columns are powder coated black (PC-06).
- Base must be floor mounted on site by others according to acceptable means.
- Wires are concealed by the column and are hidden from view.
- Connectivity solutions include Vox® Double Sided Forum and Vox® Simple PopUp Forum
- Electric, ultra quiet height adjustable system with a variety of touch controls. Contact customer service for details 800.668.9318.



VOX® LCS TABLES

RACETRACK SHAPE Design Nienkämper , Jeremy Gibson



Specify edge type; add the two letter code after the model number.



Facet Edge (FC)



Taper Edge (TE)



Flowform Edge (FF)
5% upcharge
laminates not available



Camber Edge (CE)
5% upcharge
laminates not available

Model Number	W"	D"	H"	Top Finish	List Price	Model Number	W"	D"	H"	Top Finish	List Price	Standard Features:
Fixed Height (Seating)						Fixed Height (Standing)						<ul style="list-style-type: none"> Tops available in all Nienkämper standard veneers, finishes and plastic laminates. Black Neather wrapped base with contrasting stitch is standard but all Nienkämper Neathers are also available. Shrouds and columns are powder coated black (PC-06). Base must be floor mounted on site by others according to acceptable means. Wires are concealed by the column and are hidden from view. Connectivity solutions include Vox® Double Sided Forum and Vox® Simple PopUp Forum
34461/230	96	42	29	Veneer	20,200	34461/238	96	42	38	Veneer	21,860	
34461/530	96	42	29	P-Lam	19,145	34461/538	96	42	38	P-Lam	20,805	
34462/230	96	48	29	Veneer	20,445	34462/238	96	48	38	Veneer	22,105	
34462/530	96	48	29	P-Lam	19,335	34462/538	96	48	38	P-Lam	21,000	
34463/230	96	54	29	Veneer	20,705	34463/238	96	54	38	Veneer	22,365	
34463/530	96	54	29	P-Lam	19,530	34463/538	96	54	38	P-Lam	21,200	
34464/230	96	60	29	Veneer	20,980	34464/238	96	60	38	Veneer	22,640	
34464/530	96	60	29	P-Lam	19,760	34464/538	96	60	38	P-Lam	21,415	
34465/230	108	42	29	Veneer	20,505	34465/238	108	42	38	Veneer	22,175	
34465/530	108	42	29	P-Lam	19,255	34465/538	108	42	38	P-Lam	20,915	
34466/230	108	48	29	Veneer	20,890	34466/238	108	48	38	Veneer	22,555	
34466/530	108	48	29	P-Lam	19,590	34466/538	108	48	38	P-Lam	21,245	
34467/230	108	54	29	Veneer	21,030	34467/238	108	54	38	Veneer	22,695	
34467/530	108	54	29	P-Lam	19,650	34467/538	108	54	38	P-Lam	21,315	
34468/230	108	60	29	Veneer	21,315	34468/238	108	60	38	Veneer	22,970	
34468/530	108	60	29	P-Lam	19,840	34468/538	108	60	38	P-Lam	21,495	
34469/230	120	42	29	Veneer	20,775	34469/238	120	42	38	Veneer	22,440	
34469/530	120	42	29	P-Lam	19,505	34469/538	120	42	38	P-Lam	21,170	
34470/230	120	48	29	Veneer	21,275	34470/238	120	48	38	Veneer	22,945	
34470/530	120	48	29	P-Lam	19,760	34470/538	120	48	38	P-Lam	21,415	
34471/230	120	54	29	Veneer	21,720	34471/238	120	54	38	Veneer	23,390	
34471/530	120	54	29	P-Lam	20,000	34471/538	120	54	38	P-Lam	21,670	
34472/230	120	60	29	Veneer	22,030	34472/238	120	60	38	Veneer	23,690	
34472/530	120	60	29	P-Lam	20,115	34472/538	120	60	38	P-Lam	21,785	
34473/230	132	42	29	Veneer	21,170	34473/238	132	42	38	Veneer	22,840	
34473/530	132	42	29	P-Lam	19,760	34473/538	132	42	38	P-Lam	21,415	
34474/230	132	48	29	Veneer	21,610	34474/238	132	48	38	Veneer	23,275	
34474/530	132	48	29	P-Lam	19,980	34474/538	132	48	38	P-Lam	21,640	
34475/230	132	54	29	Veneer	22,105	34475/238	132	54	38	Veneer	23,775	
34475/530	132	54	29	P-Lam	20,115	34475/538	132	54	38	P-Lam	21,785	
34476/230	132	60	29	Veneer	22,365	34476/238	132	60	38	Veneer	24,025	
34476/530	132	60	29	P-Lam	20,285	34476/538	132	60	38	P-Lam	21,955	
34477/230	144	42	29	Veneer	21,495	34477/238	144	42	38	Veneer	23,170	
34477/530	144	42	29	P-Lam	19,895	34477/538	144	42	38	P-Lam	21,560	
34478/230	144	48	29	Veneer	21,975	34478/238	144	48	38	Veneer	23,645	
34478/530	144	48	29	P-Lam	20,200	34478/538	144	48	38	P-Lam	21,860	
34479/230	144	54	29	Veneer	22,530	34479/238	144	54	38	Veneer	24,185	
34479/530	144	54	29	P-Lam	20,420	34479/538	144	54	38	P-Lam	22,085	
34480/230	144	60	29	Veneer	22,970	34480/238	144	60	38	Veneer	24,630	
34480/530	144	60	29	P-Lam	20,705	34480/538	144	60	38	P-Lam	22,365	
34481/230	156	42	29	Veneer	21,755	34481/238	156	42	38	Veneer	23,415	
34481/530	156	42	29	P-Lam	20,065	34481/538	156	42	38	P-Lam	21,720	
34482/230	156	48	29	Veneer	22,305	34482/238	156	48	38	Veneer	23,970	
34482/530	156	48	29	P-Lam	20,445	34482/538	156	48	38	P-Lam	22,105	
34483/230	156	54	29	Veneer	22,945	34483/238	156	54	38	Veneer	24,610	
34483/530	156	54	29	P-Lam	20,725	34483/538	156	54	38	P-Lam	22,400	
34484/230	156	60	29	Veneer	23,445	34484/238	156	60	38	Veneer	25,105	
34484/530	156	60	29	P-Lam	21,030	34484/538	156	60	38	P-Lam	22,695	

VOX® LCS TABLES

RACETRACK SHAPE Design Nienkämper , Jeremy Gibson



Specify edge type; add the two letter code after the model number.

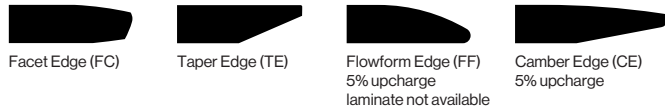

All Boat shape table sizes available with optional 6" radius "Soft" corner (must be specified at time of order)

Model Number	W"	D"	H"	Top Finish	List Price
Adjustable Height					
34485/23045	96	42	29½-42	Veneer	26,440
34485/53045	96	42	29½-42	P-Lam	25,390
34486/23045	96	48	29½-42	Veneer	26,695
34486/53045	96	48	29½-42	P-Lam	25,580
34487/23045	96	54	29½-42	Veneer	26,945
34487/53045	96	54	29½-42	P-Lam	25,770
34488/23045	96	60	29½-42	Veneer	27,220
34488/53045	96	60	29½-42	P-Lam	25,995
34489/23045	108	42	29½-42	Veneer	26,745
34489/53045	108	42	29½-42	P-Lam	25,500
34490/23045	108	48	29½-42	Veneer	27,140
34490/53045	108	48	29½-42	P-Lam	25,840
34491/23045	108	54	29½-42	Veneer	27,275
34491/53045	108	54	29½-42	P-Lam	25,880
34492/23045	108	60	29½-42	Veneer	27,545
34492/53045	108	60	29½-42	P-Lam	26,080
34493/23045	120	42	29½-42	Veneer	27,030
34493/53045	120	42	29½-42	P-Lam	25,750
34494/23045	120	48	29½-42	Veneer	27,525
34494/53045	120	48	29½-42	P-Lam	25,995
34495/23045	120	54	29½-42	Veneer	27,960
34495/53045	120	54	29½-42	P-Lam	26,240
34496/23045	120	60	29½-42	Veneer	28,275
34496/53045	120	60	29½-42	P-Lam	26,365
34497/23045	132	42	29½-42	Veneer	27,415
34497/53045	132	42	29½-42	P-Lam	25,995
34498/23045	132	48	29½-42	Veneer	27,860
34498/53045	132	48	29½-42	P-Lam	26,215
34499/23045	132	54	29½-42	Veneer	28,360
34499/53045	132	54	29½-42	P-Lam	26,365
34500/23045	132	60	29½-42	Veneer	28,615
34500/53045	132	60	29½-42	P-Lam	26,530
34501/23045	144	42	29½-42	Veneer	27,745
34501/53045	144	42	29½-42	P-Lam	26,140
34502/23045	144	48	29½-42	Veneer	28,215
34502/53045	144	48	29½-42	P-Lam	26,440
34503/23045	144	54	29½-42	Veneer	28,770
34503/53045	144	54	29½-42	P-Lam	26,660
34504/23045	144	60	29½-42	Veneer	29,220
34504/53045	144	60	29½-42	P-Lam	26,945
34505/23045	156	42	29½-42	Veneer	28,000
34505/53045	156	42	29½-42	P-Lam	26,305
34506/23045	156	48	29½-42	Veneer	28,540
34506/53045	156	48	29½-42	P-Lam	26,695
34507/23045	156	54	29½-42	Veneer	29,175
34507/53045	156	54	29½-42	P-Lam	26,965
34508/23045	156	60	29½-42	Veneer	29,695
34508/53045	156	60	29½-42	P-Lam	27,275

Standard Features:

- Tops available in all Nienkämper standard veneers, finishes and plastic laminates.
- Black Neather wrapped base with contrasting stitch is standard but all Nienkämper Neathers are also available.
- Shrouds and columns are powder coated black (PC-06).
- Base must be floor mounted on site by others according to acceptable means.
- Wires are concealed by the column and are hidden from view.
- Connectivity solutions include Vox® Double Sided Forum and Vox® Simple PopUp Forum
- Electric, ultra quiet height adjustable system with a variety of touch controls. Contact customer service for details 800.668.9318.



VOX® LCSTABLES

SUPER ELLIPSE SHAPE Design Nienkämper , Jeremy Gibson



Specify edge type; add the two letter code after the model number.



Facet Edge (FC)



Taper Edge (TE)



Flowform Edge (FF)
5% upcharge
laminates not available



Camber Edge (CE)
5% upcharge
laminates not available

Model Number	W"	D"	H"	Top Finish	List Price	Model Number	W"	D"	H"	Top Finish	List Price	Standard Features:
Fixed Height (Seating)												
34511/230	96	42	29	Veneer	20,575	34511/238	96	42	38	Veneer	22,275	<ul style="list-style-type: none"> Tops available in all Nienkämper standard veneers, finishes and plastic laminates. Black Neather wrapped base with contrasting stitch is standard but all Nienkämper Neathers are also available. Shrouds and columns are powder coated black (PC-06). Base must be floor mounted on site by others according to acceptable means. Wires are concealed by the column and are hidden from view. Connectivity solutions include Vox® Double Sided Forum and Vox® Simple PopUp Forum
34511/530	96	42	29	P-Lam	19,505	34511/538	96	42	38	P-Lam	21,200	
34512/230	96	48	29	Veneer	20,830	34512/238	96	48	38	Veneer	22,530	
34512/530	96	48	29	P-Lam	19,700	34512/538	96	48	38	P-Lam	21,400	
34513/230	96	54	29	Veneer	21,095	34513/238	96	54	38	Veneer	22,785	
34513/530	96	54	29	P-Lam	19,900	34513/538	96	54	38	P-Lam	21,595	
34514/230	96	60	29	Veneer	21,370	34514/238	96	60	38	Veneer	23,065	
34514/530	96	60	29	P-Lam	20,125	34514/538	96	60	38	P-Lam	21,815	
34515/230	108	42	29	Veneer	20,885	34515/238	108	42	38	Veneer	22,590	
34515/530	108	42	29	P-Lam	19,610	34515/538	108	42	38	P-Lam	21,315	
34516/230	108	48	29	Veneer	21,275	34516/238	108	48	38	Veneer	22,980	
34516/530	108	48	29	P-Lam	19,960	34516/538	108	48	38	P-Lam	21,645	
34517/230	108	54	29	Veneer	21,435	34517/238	108	54	38	Veneer	23,125	
34517/530	108	54	29	P-Lam	20,010	34517/538	108	54	38	P-Lam	21,705	
34518/230	108	60	29	Veneer	21,705	34518/238	108	60	38	Veneer	23,405	
34518/530	108	60	29	P-Lam	20,210	34518/538	108	60	38	P-Lam	21,910	
34519/230	120	42	29	Veneer	21,170	34519/238	120	42	38	Veneer	22,870	
34519/530	120	42	29	P-Lam	19,875	34519/538	120	42	38	P-Lam	21,575	
34520/230	120	48	29	Veneer	21,685	34520/238	120	48	38	Veneer	23,370	
34520/530	120	48	29	P-Lam	20,125	34520/538	120	48	38	P-Lam	21,815	
34521/230	120	54	29	Veneer	22,125	34521/238	120	54	38	Veneer	23,825	
34521/530	120	54	29	P-Lam	20,370	34521/538	120	54	38	P-Lam	22,080	
34522/230	120	60	29	Veneer	22,440	34522/238	120	60	38	Veneer	24,135	
34522/530	120	60	29	P-Lam	20,495	34522/538	120	60	38	P-Lam	22,195	
34523/230	132	42	29	Veneer	21,575	34523/238	132	42	38	Veneer	23,265	
34523/530	132	42	29	P-Lam	20,125	34523/538	132	42	38	P-Lam	21,815	
34524/230	132	48	29	Veneer	22,025	34524/238	132	48	38	Veneer	23,705	
34524/530	132	48	29	P-Lam	20,350	34524/538	132	48	38	P-Lam	22,045	
34525/230	132	54	29	Veneer	22,530	34525/238	132	54	38	Veneer	24,230	
34525/530	132	54	29	P-Lam	20,495	34525/538	132	54	38	P-Lam	22,195	
34526/230	132	60	29	Veneer	22,785	34526/238	132	60	38	Veneer	24,480	
34526/530	132	60	29	P-Lam	20,660	34526/538	132	60	38	P-Lam	22,360	
34527/230	144	42	29	Veneer	21,910	34527/238	144	42	38	Veneer	23,610	
34527/530	144	42	29	P-Lam	20,275	34527/538	144	42	38	P-Lam	21,965	
34528/230	144	48	29	Veneer	22,395	34528/238	144	48	38	Veneer	24,085	
34528/530	144	48	29	P-Lam	20,575	34528/538	144	48	38	P-Lam	22,275	
34529/230	144	54	29	Veneer	22,955	34529/238	144	54	38	Veneer	24,645	
34529/530	144	54	29	P-Lam	20,805	34529/538	144	54	38	P-Lam	22,510	
34530/230	144	60	29	Veneer	23,405	34530/238	144	60	38	Veneer	25,095	
34530/530	144	60	29	P-Lam	21,095	34530/538	144	60	38	P-Lam	22,785	
34531/230	156	42	29	Veneer	22,175	34531/238	156	42	38	Veneer	23,865	
34531/530	156	42	29	P-Lam	20,440	34531/538	156	42	38	P-Lam	22,125	
34532/230	156	48	29	Veneer	22,725	34532/238	156	48	38	Veneer	24,415	
34532/530	156	48	29	P-Lam	20,830	34532/538	156	48	38	P-Lam	22,530	
34533/230	156	54	29	Veneer	23,370	34533/238	156	54	38	Veneer	25,075	
34533/530	156	54	29	P-Lam	21,120	34533/538	156	54	38	P-Lam	22,810	
34534/230	156	60	29	Veneer	23,890	34534/238	156	60	38	Veneer	25,575	
34534/530	156	60	29	P-Lam	21,435	34534/538	156	60	38	P-Lam	23,125	

VOX® LCSTABLES

SUPER ELLIPSE SHAPE Design Nienkämper , Jeremy Gibson



Specify edge type; add the two letter code after the model number.



Facet Edge (FC)



Taper Edge (TE)



Flowform Edge (FF)
5% upcharge
laminates not available



Camber Edge (CE)
5% upcharge

Model Number W" D" H" Top Finish List Price

Standard Features:

Adjustable Height

34535/23045	96	42	29½-42	Veneer	26,945
34535/53045	96	42	29½-42	P-Lam	25,865
34536/23045	96	48	29½-42	Veneer	27,190
34536/53045	96	48	29½-42	P-Lam	26,070
34537/23045	96	54	29½-42	Veneer	27,450
34537/53045	96	54	29½-42	P-Lam	26,260
34538/23045	96	60	29½-42	Veneer	27,735
34538/53045	96	60	29½-42	P-Lam	26,490
34539/23045	108	42	29½-42	Veneer	27,260
34539/53045	108	42	29½-42	P-Lam	25,980
34540/23045	108	48	29½-42	Veneer	27,645
34540/53045	108	48	29½-42	P-Lam	26,325
34541/23045	108	54	29½-42	Veneer	27,785
34541/53045	108	54	29½-42	P-Lam	26,375
34542/23045	108	60	29½-42	Veneer	28,070
34542/53045	108	60	29½-42	P-Lam	26,575
34543/23045	120	42	29½-42	Veneer	27,530
34543/53045	120	42	29½-42	P-Lam	26,230
34544/23045	120	48	29½-42	Veneer	28,050
34544/53045	120	48	29½-42	P-Lam	26,490
34545/23045	120	54	29½-42	Veneer	28,495
34545/53045	120	54	29½-42	P-Lam	26,740
34546/23045	120	60	29½-42	Veneer	28,800
34546/53045	120	60	29½-42	P-Lam	26,850
34547/23045	132	42	29½-42	Veneer	27,930
34547/53045	132	42	29½-42	P-Lam	26,490
34548/23045	132	48	29½-42	Veneer	28,385
34548/53045	132	48	29½-42	P-Lam	26,710
34549/23045	132	54	29½-42	Veneer	28,890
34549/53045	132	54	29½-42	P-Lam	26,850
34550/23045	132	60	29½-42	Veneer	29,145
34550/53045	132	60	29½-42	P-Lam	27,030
34551/23045	144	42	29½-42	Veneer	28,275
34551/53045	144	42	29½-42	P-Lam	26,625
34552/23045	144	48	29½-42	Veneer	28,745
34552/53045	144	48	29½-42	P-Lam	26,945
34553/23045	144	54	29½-42	Veneer	29,320
34553/53045	144	54	29½-42	P-Lam	27,170
34554/23045	144	60	29½-42	Veneer	29,770
34554/53045	144	60	29½-42	P-Lam	27,450
34555/23045	156	42	29½-42	Veneer	28,525
34555/53045	156	42	29½-42	P-Lam	26,805
34556/23045	156	48	29½-42	Veneer	29,085
34556/53045	156	48	29½-42	P-Lam	27,190
34557/23045	156	54	29½-42	Veneer	29,735
34557/53045	156	54	29½-42	P-Lam	27,475
34558/23045	156	60	29½-42	Veneer	30,250
34558/53045	156	60	29½-42	P-Lam	27,785

- Tops available in all Nienkämper standard veneers, finishes and plastic laminates.
- Black Neather wrapped base with contrasting stitch is standard but all Nienkämper Neathers are also available.
- Shrouds and columns are powder coated black (PC-06).
- Base must be floor mounted on site by others according to acceptable means.
- Wires are concealed by the column and are hidden from view.
- Connectivity solutions include Vox® Double Sided Forum and Vox® Simple PopUp Forum
- Electric, ultra quiet height adjustable system with a variety of touch controls. Contact customer service for details 800.668.9318.



VOX® LCSTABLES

ROUND SHAPE

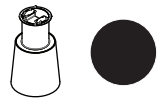

Specify edge type; add the two letter code after the model number.

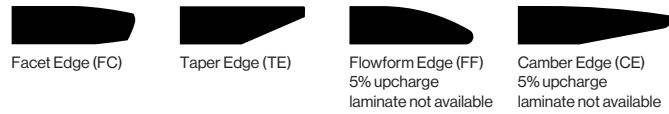

Facet Edge (FC) Taper Edge (TE) Flowform Edge (FF) 5% upcharge laminate not available Camber Edge (CE) 5% upcharge laminate not available

Model Number	W"	D"	H"	Top Finish	List Price	Model Number	W"	D"	H"	Top Finish	List Price
--------------	----	----	----	------------	------------	--------------	----	----	----	------------	------------

Fixed Height (Seating)

34561/230	48 Dia.		29	Veneer	8,595
34561/530	48 Dia.		29	P-Lam	7,950
34562/230	54 Dia.		29	Veneer	8,990
34562/530	54 Dia.		29	P-Lam	8,075
34563/230	60 Dia.		29	Veneer	9,385
34563/530	60 Dia.		29	P-Lam	8,210

Fixed Height (Standing)

34561/238	48 Dia.		38	Veneer	9,385
34561/538	48 Dia.		38	P-Lam	8,730
34562/238	54 Dia.		38	Veneer	9,780
34562/538	54 Dia.		38	P-Lam	8,860
34563/238	60 Dia.		38	Veneer	10,165
34563/538	60 Dia.		38	P-Lam	8,990

Adjustable Height

34565/23045	48 Dia.		29½-42	Veneer	11,510
34565/53045	48 Dia.		29½-42	P-Lam	10,855
34566/23045	54 Dia.		29½-42	Veneer	11,895
34566/53045	54 Dia.		29½-42	P-Lam	10,985
34567/23045	60 Dia.		29½-42	Veneer	12,300
34567/53045	60 Dia.		29½-42	P-Lam	11,115

Standard Features:

- Tops available in all Nienkämper standard veneers, finishes and plastic laminates.
- Black Neather wrapped base with contrasting stitch is standard but all Nienkämper Neathers are also available.
- Shrouds and columns are powder coated black (PC-06).
- Base must be floor mounted on site by others according to acceptable means.
- Wires are concealed by the column and are hidden from view.
- Connectivity solutions include Vox® Double Sided Forum and Vox® Simple PopUp Forum
- Electric, ultra quiet height adjustable system with a variety of touch controls. Contact customer service for details 800.668.9318.



WIRING VOX® TABLES

VOX® TABLE WITH LCS BASE

LCS Base

The Vox® LCS Base features slide-to-open exterior panels that provide easy access to wiring while keeping cables neatly concealed. Its generous footprint at floor level offers ample space to hide cabling, core drills, or floor monuments for a clean and organized appearance.

The LCS Base mounts directly to the floor (by others) on site and is available in a single size: 48 ¾" x 17 ¼". Refer to pages 17–21 for detailed dimensions and interior clearances.

After routing cabling through the base to the underside of the top, secure it using the included self-adhesive Wire Management Strips. A metal wire pan mounts to the steel frame to conceal the cables.

When specifying multiple Vox® Forums to be hard-wired on site, the electrician should allow for one J-Box per Forum on the underside of the top to complete site wiring.

Voice and data cabling can also be consolidated by mounting a Data Hub (provided by others) to the underside of the table.

1. LCS Base
2. Steel Support Frame
3. Wire Management Pan
4. Surge Protector
5. Vox® Forum

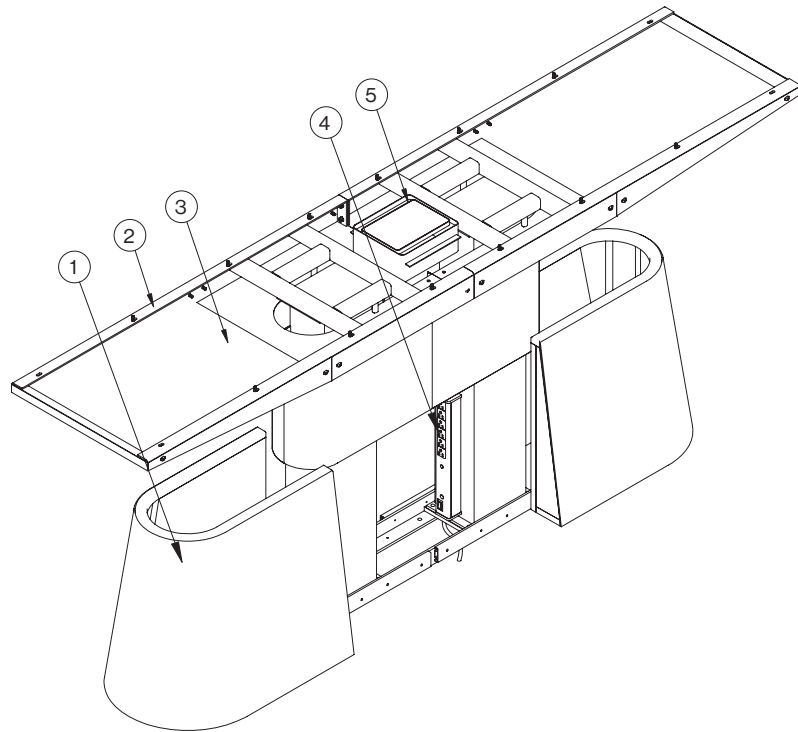

TERMS AND CONDITIONS OF SALE

PRICES

All prices are list prices, FOB our Toronto Factory- freight charges are extra. Packing and/ or crating is available, if required, upcharges apply.

Due to existing conditions in regard to cost of labor and materials, we reserve the right to change prices without notice.

TERMS

Net 30 days from date of invoice to accredited buyers. Two per cent (2%) interest charged monthly on overdue accounts. Deposit of 50% is required with order. Terms will be established upon credit evaluation. Due to delays in processing references, first orders may be treated as C.B.D. orders.

ORDER CONFIRMATION

Orders are accepted upon issuance of our order confirmation and are subject to the terms set forth therein; notwithstanding any variance from the terms of the buyer's order form.

Nienkämper is not liable for any delay or failure to deliver caused by labor or transportation difficulties, accidents, acts of God, failure of sources of supply, or other causes beyond our control, and changes will affect the delivery date.

CHANGE OF ORDERS OR CANCELLATIONS

Changes or cancellations are subject to our ability to conform. A charge will be levied against canceled or changed orders based on costs already incurred by Nienkämper. All changes must be in writing and submitted on a revised purchase order. Changes will affect the delivery date.

STORAGE

If goods cannot be accepted when ready, we may transfer them to storage (which is to be deemed as delivery for invoice purposes). The customer accepts risks and will be charged at prevailing rates.

FREIGHT

All prices are list prices, FOB our Toronto Factory- freight charges are extra.

Packing and/or crating are available, if required, upcharges apply.

CLAIMS

All furniture is given to the carrier and signed for in good condition. It is the responsibility of the receiver to sign for the goods in the presence of the carrier and note the condition in which they are received. Freight claims should be filed with the carrier.

WARRANTY

There are no express or implied warranties, conditions and obligations of the manufacturer, whether statutory or otherwise that extend beyond the description on the face hereof. Our furniture is made to the highest standard and is warranted free from defects of material and workmanship for five years from the date of delivery. During the warranty period we will repair or replace such merchandise as shall prove to be defective, during normal usage in accordance with manufacturer's specifications. The manufacturer shall not be liable for defect wholly attributable to normal manufacturing process. Replacement or repair of the Product shall be the sole remedy of the Customer, and the manufacturer shall not be liable for any direct, indirect, incidental, or consequential loss or damage suffered by the Customer by reason of any defect in workmanship or manufacture of the Product or inability to use the Product. Moreover, this warranty does not cover accidental damage, abuse, alteration, ordinary wear and tear of Goods, negligence and misuse nor variations over which we have no control such as heat or humidity or damage to which the Goods are connected that is not attributable to the failure of the goods themselves. This warranty is null and void when the product is installed with hardware other than that supplied and/or when installed differently than recommended in the installation guide. Modification to the product or hardware may result in failure of the product and cause damage and/or injury.

WOOD FINISHES

Nienkämper offers a wide variety of standard light finishes on cherry, mahogany and figured anagre wood veneers, and a clear natural finish on figured anagre, figured sycamore, maple, bird's eye maple and curly maple.

Light finishes do not mask the grain and other characteristics of each wood species. It is important to understand that pieces of the same type of wood will not look identical when a light finish is used. The appearance of the finish will also depend on the natural color of the veneer. Cherry darkens over time as the wood ages. Pin knots and gum pockets are inherent traits.

Wood is a naturally variable raw material; its variances are not within the furniture manufacturer's control and are therefore not considered defects under this warranty.