

nienkämpfer

CONFERENCE TABLES

UNA COLLECTION



2026

Prices include freight charges, blanket wrapped, dock delivered, from the manufacturing source to any location in the contiguous United States. Packing and/or crating are available, if required, upcharges apply.

veneers

All wood surfaces are protected with a durable polyurethane clear lacquer with UV inhibitor. This finish is known for its exceptional durability, as well as abrasion, chemical, impact and scratch resistance. Standard sheen level is 45 degrees. Optional matte, 5, 10 and 35 degree sheen levels are available on request at no additional cost.

Wood Species	Order Code	Veneer/Stain	Upcharge
Maple	F-01	Natural Maple	No upcharge applies.
	F-02	Natural Curly Maple - Rotary Cut	Add 15%.
	F-03	Natural Bird's Eye Maple - Rotary Cut	Call Customer Service for pricing.
	F-04	Maple Stained Pear	No upcharge applies.
Cherry	F-05	Natural Cherry	No upcharge applies.
	F-06	Standard Cherry	No upcharge applies.
	F-07	Cherry Stained Amber	No upcharge applies.
	F-08	Cherry Stained Auburn	No upcharge applies.
	F-09	Cherry Stained Burgundy	No upcharge applies.
Mahogany	F-10	Light Mahogany	No upcharge applies.
	F-11	Medium Mahogany	No upcharge applies.
	F-12	Dark Mahogany	No upcharge applies.
	F-13	Red Mahogany	No upcharge applies.
Anagre	F-14	Natural Figured Anagre - Qtr. Cut Book-Match	Add 15%.
	F-15	Figured Anagre Stained Amber - Qtr. Cut Book-Match	Add 15%.
Sycamore	F-16	Natural Figured Sycamore - Qtr. Cut Book-Match	Add 15%.
Walnut	F-17	Burnt Walnut	No upcharge applies.
	F-19	Natural Walnut- Flat Cut Book-Match	No upcharge applies.
	F-19FM	Natural Walnut- Flat Cut Book-Match (matte sheen)	No upcharge applies.
	F-27F	Creamy Walnut- Flat Cut Book-Match (10° sheen)	No upcharge applies.
	F-27R	Creamy Walnut - Rift Cut Slip-Match (10° sheen)	Add 5%
	F-28	Tawny Walnut	No upcharge applies.
	F-31FM	Autumn Walnut- Flat Cut Book-Match (matte sheen)	No upcharge applies.
	F-31RM	Autumn Walnut - Rift Cut Slip-Match (matte sheen)	Add 5%
Oak	F-18F	Natural White Oak - Flat Cut Book-Match (10° sheen)	No upcharge applies.
	F-18R	Natural White Oak - Rift Cut Slip-Match (10° sheen)	Add 5%
	F-26	Charcoal Ash On Oak- Flat Cut Book- Match (10° sheen)	No upcharge applies.
	F-29F	Smoky Oak - Flat Cut Book-Match	No upcharge applies.
	F-29R	Smoky Oak - Rift Cut Slip-Match	Add 5%
	F-29FM	Smoky Oak - Flat Cut Book-Match (matte sheen)	No upcharge applies.
	F-29RM	Smoky Oak - Rift Cut Slip-Match (matte sheen)	Add 5%
	F-30FM	Whisper White Oak - Flat Cut Book-Match (matte sheen)	No upcharge applies.
	F-30RM	Whisper White Oak - Rift Cut Slip-Match (matte sheen)	Add 5%
	F-32FM	Cotton White Oak - Flat Cut Book-Match (matte sheen)	No upcharge applies.
F-32RM	Cotton White Oak - Rift Cut Slip-Match (matte sheen)	Add 5%	
Sapele – Ribbon Stripe	F-20	Natural Ribbon Strip Sapele - Qtr. Cut Slip-Match	No upcharge applies.
Moabi (Cherry substitute)	F-21	Natural Moabi - Quarter - Qtr. Cut Book-Match	No upcharge applies.
Cape Coast Walnut	F-22	Dark Cape Coast Walnut - Qtr. Cut Slip-Match	No upcharge applies.
	F-23	Natural Cape Coast Walnut - Qtr. Cut Slip-Match	No upcharge applies.
	F-23	Natural Cape Coast Walnut - Qtr. Cut Slip-Match	No upcharge applies.
Ash	F-25	Slate Gray Ash - Qtr. Cut Slip-Match	No upcharge applies.

veneER GRAIN OPTIONS

Nienkämper products utilize the best quality veneers available, and, combined with Nienkämper's patented veneering systems, create work environments of incredible quality and beauty.

All veneer furniture comes standard with flat cut book-match veneer; flat cut slip-match veneer can also be specified. Quarter cut slip-match and quarter cut book-match veneers are available at a 5% upcharge. Figured Anagre and Figured Sycamore veneers are Quarter cut book-matched. Bird's Eye Maple and Curly Maple are rotary cut. Facet Edge, Taper edge, Flowform, Camber and Self edge tops with veneer are manufactured with a solid wood edge. All edges are then veneer wrapped to create a seamless profile top.

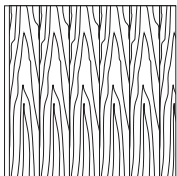

Standard V1
Flat Cut Book-Match

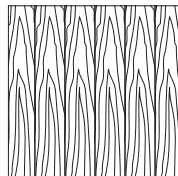

Flat Cut Slip-Match V2

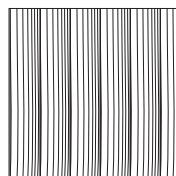

Quarter Cut Slip-Match V3
Add 5%

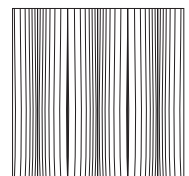

Quarter Cut Book-Match V4
Add 5%

P-LAM

Wood grain plastic laminate surfaces are available on table tops with Facet, Taper and Self edges.

These tops are manufactured with a solid wood edge that is applied prior to the laminate top surface. This method conceals the thickness of the wood edge, while providing the durability required. Wood edges are selected that most closely resemble both the species and the color of the laminate chosen

Nienkämper has pre-selected a number of standard wood grain plastic laminates that represent a cross section of both color and species. Simply include the order code with the model number to make these selections. Alternatively wood grain plastic laminates selected outside of Nienkämper's standard selection can be made by specifying the manufacturer as well as the description and model number of the laminate at the time of order.

Wood Grain Plastic Laminate Surfaces	Order Code	Manufacturer #	Finish
Hardrock Maple	WL2	Pionite WM791-SD	Textured/Suede
Monticello Maple	WL5	Wilsonart 7925-38	Fine Velvet Texture
Fusion Maple	WL13	Wilsonart 7909-60	Matte
New Age Oak	WL14	Wilsonart 7938-38	Fine Velvet Texture
Wild Cherry	WL18	Wilsonart 7054-60	Matte
River Cherry	WL19	Wilsonart 7937-38	Fine Velvet Texture
Montana Walnut	WL20	Wilsonart 7110T-78	Fine Grain
Skyline Walnut	WL26	Wilsonart 7964K-12	Soft Grain
Continental Walnut	WL-29	Wilsonart 8232K-05	Timbergrain
Neo Walnut	WL-30	Wilsonart 7991-38	Fine Velvet Texture
Walnut Heights	WL-31	Wilsonart 7965K-12	Soft Grain
Grayed Oak	WL-32	Formica 5791-PG	Pure Grain Texture
Millennium Oak	WL-33	Formica 5887-58	Matte
Aged Ash	WL-34	Formica 8844-WR	Woodbrush
Lowell Ash	WL-35	Wilsonart 7994-38	Fine Velvet Texture
Natural Ash	WL-36	Formica 8843-WR	Woodbrush
Norwegian Ash	WL-37	Wilsonart 8241-38	Fine Velvet Texture
Weathered Ash	WL-38	Formica 8842-WR	Woodbrush
Smoky Brown Pear	WL-39	Formica 5488-26	Oiled Wood
Studio Teak	WL-40	Wilsonart 7960K-18	Linearity
Fawn Cypress	WL-41	Wilsonart 8208K-16	Casual Rustic
Landmark Wood	WL-42	Wilsonart 7981K-12	Soft Grain
Natural Cerise	WL-43	Formica 8863-58	Matte
Natural Recon	WL-44	Wilsonart 7996-38	Fine Velvet Texture
Pecan Woodline	WL-45	Formica 5883-58	Matte

To specify the wood grain laminate required simply add the Order Code WL_ to the model number of the product.

Samples and specific technical data is available from your local sales representative or by contacting Nienkämper's Customer Service department at **800.668.9318**.

P-LAM

COLORED P-LAM

Both Taper and Self edge profiles are available with a colored laminate top.

Laminate edging on Taper tops. Edging will match the top surface and is applied before the surface laminate. By applying the laminate in this way, the seam is positioned horizontally, which makes it much less conspicuous and more durable.

Wood edging on Self and Taper Edge tops are applied before the laminate. By applying the wood edge in this way, the wood edge thickness is concealed, while providing the durability required. Wood species and finishes for edging can be selected from page 8.

For laminates specified outside of Nienkämper's standard selection, specify the manufacturer as well as the description and model number of the laminate selected at the time of order. For Facet edge tops, the laminate must be a post-forming grade.

Translucent edging on Self and Taper edge tops is applied after the surface laminate. The translucent edge is very durable. Clear translucent edge provides a good match with most white-colored laminates, while a silver translucent edge provides a metallic look and contrast to colored plastic laminates.



P-Lam top & Self edge



P-Lam top & Translucent Self edge

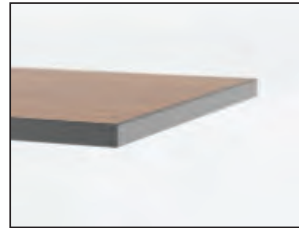

Wood Grain P-Lam top & silver Translucent Self edge

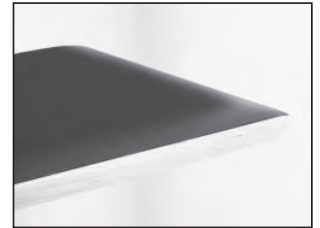

P-Lam top & solid wood Facet edge

*An unavoidable, thin dark line will be visible when specifying a matching p.lam edge. This is more pronounced with light colored laminates

Colored Plastic Laminates Surface	Order Code	Manufacturer #	Finish
Gray (Nienkämper - Light Gray/Putty)	CL-01	Wilsonart 1500-60	Matte
Platinum Gray (Nienkämper - Medium Gray/Clay)	CL-02	Nevamar S6023T	Textured
Slate Grey (Nienkämper - Dark Gray)	CL-03	Wilsonart D91-60	Matte
Black	CL-04	Wilsonart 1595-60	Matte
Angel White	CL-05	Pionite SW-826SD	Textured/ Suede
Frosty White	CL-06	Wilsonart 1573-60	Matte
White (for writable surface)	Contact customer service for details 800.668.9318		Gloss

Add the order code behind the edge profile when specifying.

P-LAM

FINGERPRINT RESISTANT P-LAM

Fingerprint Resistant Plastic Laminate is an innovative material created for interior design applications and is suitable for both vertical and horizontal interior applications on our Nienkämper furniture.

The external surface of Fingerprint Resistant Plastic Laminate involves the use of nanotechnology made possible by next generation acrylic resins.

The unique composition offers extraordinary features coupled with a unique user experience. These include an ultra matte surface (eliminating glare), an ultra sofa feel, an anti-fingerprint surface, thermal healing of micro-scratches, increased durability as well as anti-bacterial and mold-resistant properties.

Edgeband matching all Fingerprint Resistant Plastic Laminate colors is only available when specifying a Taper edge. For Self edge tops 1" and 1 1/4" thick, matching edgeband are only available in Black (RL-01) and White (RL-03). When a matching edgeband is not available, the specified surface laminate is used on the edge. **Contact Customer Service for more details 800.668-9318.**

There is a 20% upcharge on our standard plastic laminate table pricing for Fingerprint Resistant Plastic Laminate.

Colored "Fingerprint Resistant" Plastic Laminate Surface	Order Code	Finish
Black	RL-01	Matte
Gray	RL-02	Matte
White	RL-03	Matte
Sand	RL-04	Matte
Brown	RL-05	Matte
Clay	RL-06	Matte
Beige	RL-07	Matte
Ash	RL-08	Matte
Smoke	RL-09	Matte

Edgeband to Match with Colored "Fingerprint Resistant" Plastic Laminate	Thickness	Order Code
Black	3/4", 1", 1-1/4"	RE-01
Gray	3/4"	RE-02
White	3/4", 1", 1-1/4"	RE-03
Sand	3/4"	RE-04
Brown	3/4"	RE-05
Clay	3/4"	RE-06
Beige	3/4"	RE-07
Ash	3/4"	RE-08
Smoke	3/4"	RE-09

Powder Coat Paint Finish

Powder coat paint is a premium finish used for its exceptional durability and refined appearance. Applied as a dry powder and cured under heat, it forms a tough, uniform surface that resists chipping, scratching, and fading—ideal for commercial environments. Nienkämper offers a curated palette of 18 color variations to suit any project.



PC-01 Nienkämper Silver



PC-02 Champagne



PC-03 Light Bronze



PC-04 Standard (Dark) Bronze



PC-05 Metallic Silver



PC-06 Black Jack



PC-07 Warm White



PC-09 Red



PC-12 Cool White



PC-14 Pure Orange



PC-16 Lime



PC-17 Sky Blue



PC-18 Cobalt Blue



PC-22 Charcoal Gray (Matte)



PC-24 Matte Red Clay



PC-25 Cream



PC-26 Mulberry (Matte)



PC-27 Forest Green (Matte)



PC-28 Mustard (Matte)

Una CONFERENCE COLLECTION

Design - modus ID



2026

nienkämper
International Inc.

Una CONFERENCE COLLECTION

ELEMENTS

Design - modus.ID

TOP SHAPE

All tops are 1 1/4" thick.

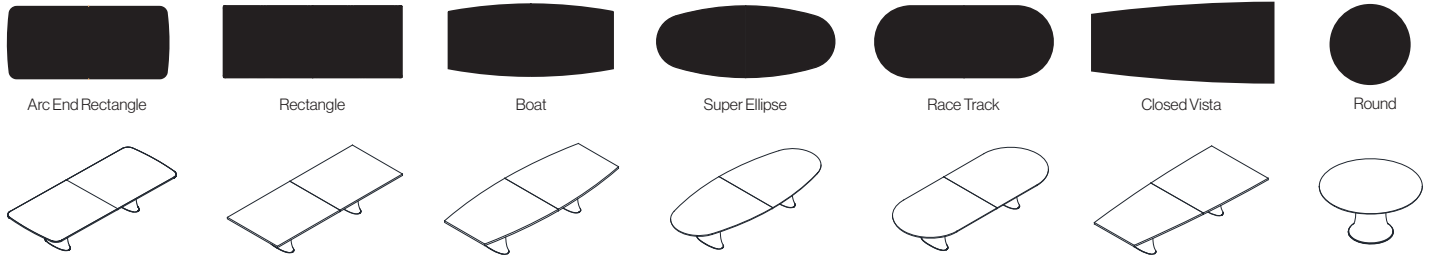

LINEAR TABLE BASE

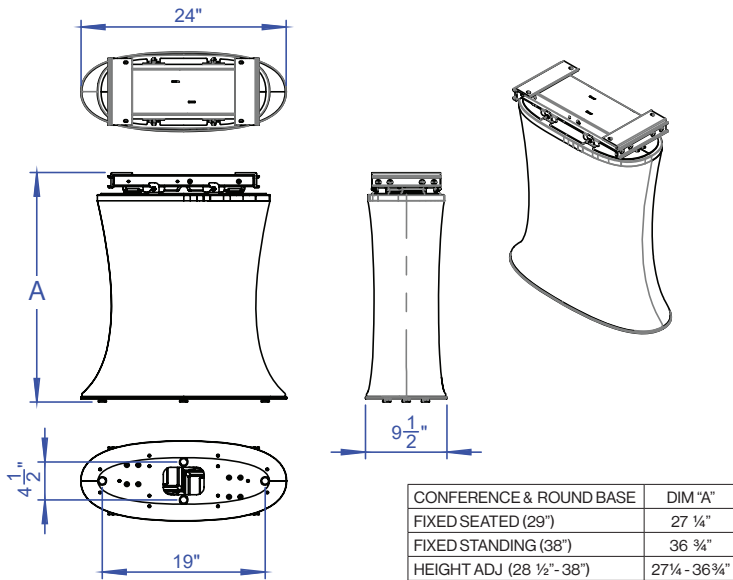

ROUND TABLE BASE

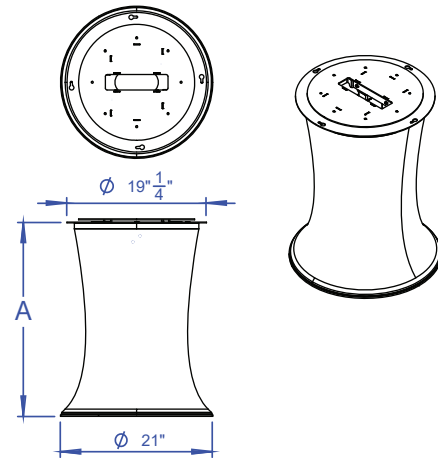

EDGE DETAILS

Specify edge type: add the two letter code after the model number.

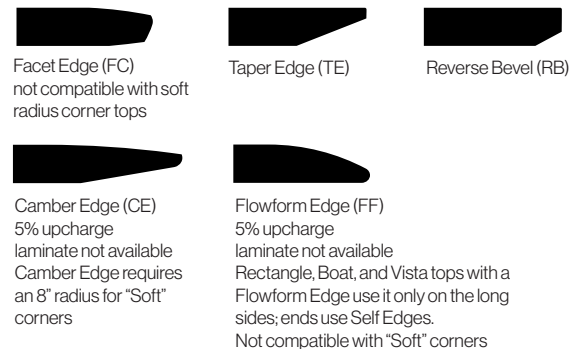

FEATURES

TOP FINISH- All standard veneers, stains and finishes. All standard plastic laminates and fingerprint resistant laminates. Tops are standard with underside painted silver but can be customized to match bases with upcharge.

STRETCHER RAILS- Standard stretcher rails are supplied in a silver anodized finish but can also be painted in all Nienkämper standard powder coat colors upon request and upcharge. Please contact customer service at **800.668.9318** for details.

BASE FABRIC- Flex Knit x 10 colors, Decorative metal base trim- standard satin Black powder coat but available with any standard Nienkämper powder coat (by special order). Please contact customer service at **800.668.9318** for details.

POWER OPTIONS- In surface units include Vox M, Double Sided and Simple Forums. Various under surface Simple Forums also available.

CABLE MANAGEMENT- All cables are managed through the Una base to the floor. Cables can also be managed with standard Nienkämper cable conduits or high capacity wire pans.

Please contact customer service at **800.668.9318** for all customization details.

FLEX KNIT COLOR COMBINATIONS



Una CONFERENCE COLLECTION

ARC END RECTANGLE SHAPE

Design - modeus ID



Specify edge type; add the two letter code after the model number.



Reverse Bevel Edge (RB)



Taper Edge (TE)



Camber Edge (CE)
8" radius required for soft corner tops
5% upcharge
laminates not available

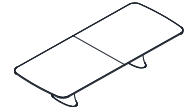

Una CONFERENCE 2 Height Adjustable Bases Table Height 28½" - 38"



L" x D"	Top Finish	Top Sections	Model Number	List Price
72 x 36	Wood	1	67071/2AEA	11,075
72 x 36	P-Lam	1	67071/5AEA	10,705
78 x 38	Wood	1	67072/2AEA	11,360
78 x 38	P-Lam	1	67072/5AEA	10,975
84 x 38	Wood	1	67073/2AEA	11,645
84 x 38	P-Lam	1	67073/5AEA	11,255
84 x 42	Wood	1	67074/2AEA	11,800
84 x 42	P-Lam	1	67074/5AEA	11,405
96 x 42	Wood	1	67075/2AEA	12,240
96 x 42	P-Lam	1	67075/5AEA	11,830
96 x 48	Wood	1	67076/2AEA	13,730
96 x 48	P-Lam	1	67076/5AEA	13,255
108 x 42	Wood	2	67077/2AEA	13,540
108 x 42	P-Lam	2	67077/5AEA	13,075
108 x 48	Wood	2	67078/2AEA	15,220
108 x 48	P-Lam	2	67078/5AEA	14,685
120 x 42	Wood	2	67079/2AEA	14,850
120 x 42	P-Lam	2	67079/5AEA	14,330
120 x 48	Wood	2	67080/2AEA	16,720
120 x 48	P-Lam	2	67080/5AEA	16,120
120 x 54	Wood	2	67081/2AEA	18,580
120 x 54	P-Lam	2	67081/5AEA	17,915
132 x 48	Wood	2	67082/2AEA	18,205
132 x 48	P-Lam	2	67082/5AEA	17,550
132 x 54	Wood	2	67083/2AEA	20,260
132 x 54	P-Lam	2	67083/5AEA	19,520
144 x 48	Wood	2	67084/2AEA	19,700
144 x 48	P-Lam	2	67084/5AEA	18,985
144 x 54	Wood	2	67085/2AEA	21,935
144 x 54	P-Lam	2	67085/5AEA	21,135

HIGH CAPACITY WIRE PAN



*Wire pan can be retrofitted to any Una Conference table

MDL# 55060

List Price: \$1,185

The Cable Management Pan is designed to conceal large volumes of cabling, retractor mechanisms, and components for M and Double Sided Forums. Ideal for narrow-depth tables, this hinged metal pan provides a clean and efficient under-table solution to keep unsightly equipment hidden.

**Image shown for general reference- your specific pan may look different

Material: Powder-coated metal

Finish: Standard silver (custom color-matching available for an upcharge)

Application: Suitable for all Linear Una Conference tables

For more details contact customer service at **800.668.9318**.

Model # 67083/2AEA



Model # 67083/5AEA

132" x 54" Arc End Rectangle



Una CONFERENCE COLLECTION

ARC END RECTANGLE SHAPE

Design - modeus ID



Specify edge type; add the two letter code after the model number.



Reverse Bevel Edge (RB)



Taper Edge (TE)



Camber Edge (CE)
8" radius required for soft corner tops
5% upcharge
laminite not available

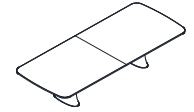

Una CONFERENCE
2 Fixed Bases
29" Table Height



Una CONFERENCE
2 Fixed Bases
38" Table Height



L" x D"	Top Finish	Top Sections	Model Number	List Price
72 x 36	Wood	1	67001/2AE	9,290
72 x 36	P-Lam	1	67001/5AE	8,920
78 x 38	Wood	1	67002/2AE	9,575
78 x 38	P-Lam	1	67002/5AE	9,190
84 x 38	Wood	1	67003/2AE	9,860
84 x 38	P-Lam	1	67003/5AE	9,470
84 x 42	Wood	1	67004/2AE	10,015
84 x 42	P-Lam	1	67004/5AE	9,620
96 x 42	Wood	1	67005/2AE	10,455
96 x 42	P-Lam	1	67005/5AE	10,045
96 x 48	Wood	1	67006/2AE	11,945
96 x 48	P-Lam	1	67006/5AE	11,470
108 x 42	Wood	2	67007/2AE	11,755
108 x 42	P-Lam	2	67007/5AE	11,290
108 x 48	Wood	2	67008/2AE	13,435
108 x 48	P-Lam	2	67008/5AE	12,900
120 x 42	Wood	2	67009/2AE	13,065
120 x 42	P-Lam	2	67009/5AE	12,545
120 x 48	Wood	2	67010/2AE	14,935
120 x 48	P-Lam	2	67010/5AE	14,335
120 x 54	Wood	2	67011/2AE	16,795
120 x 54	P-Lam	2	67011/5AE	16,130
132 x 48	Wood	2	67012/2AE	16,420
132 x 48	P-Lam	2	67012/5AE	15,765
132 x 54	Wood	2	67013/2AE	18,475
132 x 54	P-Lam	2	67013/5AE	17,735
144 x 48	Wood	2	67014/2AE	17,915
144 x 48	P-Lam	2	67014/5AE	17,200
144 x 54	Wood	2	67015/2AE	20,150
144 x 54	P-Lam	2	67015/5AE	19,350
144 x 60	Wood	2	67016/2AE	22,395
144 x 60	P-Lam	2	67016/5AE	21,495

L" x D"	Top Finish	Top Sections	Model Number	List Price
72 x 36	Wood	1	67036/2AE	9,575
72 x 36	P-Lam	1	67036/5AE	9,370
78 x 38	Wood	1	67037/2AE	9,860
78 x 38	P-Lam	1	67037/5AE	9,470
84 x 38	Wood	1	67038/2AE	10,160
84 x 38	P-Lam	1	67038/5AE	9,755
84 x 42	Wood	1	67039/2AE	10,320
84 x 42	P-Lam	1	67039/5AE	9,910
96 x 42	Wood	1	67040/2AE	10,770
96 x 42	P-Lam	1	67040/5AE	10,350
96 x 48	Wood	1	67041/2AE	12,310
96 x 48	P-Lam	1	67041/5AE	11,815
108 x 42	Wood	2	67042/2AE	12,115
108 x 42	P-Lam	2	67042/5AE	11,630
108 x 48	Wood	2	67043/2AE	13,840
108 x 48	P-Lam	2	67043/5AE	13,290
120 x 42	Wood	2	67044/2AE	13,460
120 x 42	P-Lam	2	67044/5AE	12,925
120 x 48	Wood	2	67045/2AE	15,385
120 x 48	P-Lam	2	67045/5AE	14,765
120 x 54	Wood	2	67046/2AE	17,300
120 x 54	P-Lam	2	67046/5AE	16,620
132 x 48	Wood	2	67047/2AE	16,915
132 x 48	P-Lam	2	67047/5AE	16,240
132 x 54	Wood	2	67048/2AE	19,035
132 x 54	P-Lam	2	67048/5AE	18,270
144 x 48	Wood	2	67049/2AE	18,455
144 x 48	P-Lam	2	67049/5AE	17,720
144 x 54	Wood	2	67050/2AE	20,760
144 x 54	P-Lam	2	67050/5AE	19,930
144 x 60	Wood	2	67051/2AE	23,065
144 x 60	P-Lam	2	67051/5AE	22,140

HIGH CAPACITY WIRE PAN

The Cable Management Pan is designed to conceal large volumes of cabling, retractor mechanisms, and components for M and Double Sided Forums. Ideal for narrow-depth tables, this hinged metal pan provides a clean and efficient under-table solution to keep unsightly equipment hidden.

**Image shown for general reference- your specific pan may look different

Material: Powder-coated metal
Finish: Standard silver (custom color-matching available for an upcharge)
Application: Suitable for all Linear Una Conference tables

*Wire pan can be retrofitted to any Una Conference table

MDL# 55060
List Price: \$1,185



For more details contact customer service at **800.668.9318**.

Una CONFERENCE COLLECTION

ARC END RECTANGLE SHAPE

Design - modeus ID



Specify edge type; add the two letter code after the model number.



Reverse Bevel Edge (RB)



Taper Edge (TE)



Camber Edge (CE)
8" radius required for soft corner tops
5% upcharge
laminates not available

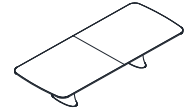

Una CONFERENCE 3 Fixed Bases 29" Table Height



Una CONFERENCE 4 Fixed Bases 29" Table Height



L" x D"	Top Finish	Top Sections	Model Number	List Price
156 48	Wood	2	67017/2AE	19,405
156 48	P-Lam	2	67017/5AE	18,635
156 54	Wood	2	67018/2AE	21,830
156 54	P-Lam	2	67018/5AE	20,965
156 60	Wood	2	67019/2AE	24,255
156 60	P-Lam	2	67019/5AE	23,290
168 48	Wood	2	67020/2AE	20,905
168 48	P-Lam	2	67020/5AE	20,070
168 54	Wood	2	67021/2AE	23,510
168 54	P-Lam	2	67021/5AE	22,570
168 60	Wood	2	67022/2AE	26,120
168 60	P-Lam	2	67022/5AE	25,080
180 48	Wood	3	67023/2AE	22,395
180 48	P-Lam	3	67023/5AE	21,495
180 54	Wood	3	67024/2AE	25,190
180 54	P-Lam	3	67024/5AE	24,190
180 60	Wood	3	67025/2AE	27,985
180 60	P-Lam	3	67025/5AE	26,500
192 54	Wood	3	67026/2AE	26,865
192 54	P-Lam	3	67026/5AE	25,795
192 60	Wood	3	67027/2AE	29,855
192 60	P-Lam	3	67027/5AE	28,660
204 54	Wood	3	67028/2AE	28,545
204 54	P-Lam	3	67028/5AE	27,405
204 60	Wood	3	67029/2AE	31,720
204 60	P-Lam	3	67029/5AE	30,450
216 54	Wood	3	67030/2AE	30,230
216 54	P-Lam	3	67030/5AE	29,025
216 60	Wood	3	67031/2AE	33,585
216 60	P-Lam	3	67031/5AE	32,250

L" x D"	Top Finish	Top Sections	Model Number	List Price
228 54	Wood	3	67032/2AE	31,905
228 54	P-Lam	3	67032/5AE	30,630
228 60	Wood	3	67033/2AE	35,450
228 60	P-Lam	3	67033/5AE	34,035
240 54	Wood	3	67034/2AE	33,585
240 54	P-Lam	3	67034/5AE	32,250
240 60	Wood	3	67035/2AE	37,315
240 60	P-Lam	3	67035/5AE	35,825

Model # 67083/2AEA

132" x 54" Arc End Rectangle



Una CONFERENCE COLLECTION

ARC END RECTANGLE SHAPE

Design - modeus ID



Specify edge type; add the two letter code after the model number.



Reverse Bevel
Edge (RB)



Taper Edge
(TE)



Camber Edge (CE)
8" radius required for soft corner tops
5% upcharge
laminates not available



Una CONFERENCE 3 Fixed Bases 38" Table Height



Una CONFERENCE 4 Fixed Bases 38" Table Height



L" x D"	Top Finish	Top Sections	Model Number	List Price
156 48	Wood	2	67052/2AE	19,990
156 48	P-Lam	2	67052/5AE	19,195
156 54	Wood	2	67053/2AE	22,490
156 54	P-Lam	2	67053/5AE	21,595
156 60	Wood	2	67054/2AE	24,985
156 60	P-Lam	2	67054/5AE	23,995
168 48	Wood	2	67055/2AE	21,535
168 48	P-Lam	2	67055/5AE	20,670
168 54	Wood	2	67056/2AE	24,220
168 54	P-Lam	2	67056/5AE	23,250
168 60	Wood	2	67057/2AE	26,910
168 60	P-Lam	2	67057/5AE	25,840
180 48	Wood	3	67058/2AE	23,065
180 48	P-Lam	3	67058/5AE	22,140
180 54	Wood	3	67059/2AE	25,950
180 54	P-Lam	3	67059/5AE	24,920
180 60	Wood	3	67060/2AE	28,825
180 60	P-Lam	3	67060/5AE	27,385
192 54	Wood	3	67061/2AE	27,675
192 54	P-Lam	3	67061/5AE	26,575
192 60	Wood	3	67062/2AE	30,750
192 60	P-Lam	3	67062/5AE	29,525
204 54	Wood	3	67063/2AE	29,410
204 54	P-Lam	3	67063/5AE	28,230
204 60	Wood	3	67064/2AE	32,675
204 60	P-Lam	3	67064/5AE	31,365
216 54	Wood	3	67065/2AE	31,140
216 54	P-Lam	3	67065/5AE	29,895
216 60	Wood	3	67066/2AE	34,595
216 60	P-Lam	3	67066/5AE	33,220

L" x D"	Top Finish	Top Sections	Model Number	List Price
228 54	Wood	3	67067/2AE	32,865
228 54	P-Lam	3	67067/5AE	31,555
228 60	Wood	3	67068/2AE	36,515
228 60	P-Lam	3	67068/5AE	35,055
240 54	Wood	3	67069/2AE	34,595
240 54	P-Lam	3	67069/5AE	33,220
240 60	Wood	3	67070/2AE	38,440
240 60	P-Lam	3	67070/5AE	36,900

Una CONFERENCE COLLECTION

RECTANGLE SHAPE

Design - modeus ID



Specify edge type; add the two letter code after the model number.



Reverse Bevel Edge (RB)



Facet Edge (FC)
not compatible with soft radius corner tops



Taper Edge (TE)



Flowform Edge (FF)
5% upcharge
laminates not available
not compatible with soft radius corner tops



Camber Edge (CE)
8" radius required for soft corner tops
5% upcharge
laminates not available

All Rectangular shape table sizes available with a 6" radius "Soft" corner (must be specified at time of order)

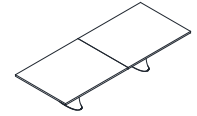

Una CONFERENCE 2 Height Adjustable Bases Table Height 28½" - 38"



L" x D"	Top Finish	Top Sections	Model Number	List Price
72 x 36	Wood	1	67071/2RTA	10,630
72 x 36	P-Lam	1	67071/5RTA	10,275
78 x 38	Wood	1	67072/2RTA	10,895
78 x 38	P-Lam	1	67072/5RTA	10,535
84 x 38	Wood	1	67073/2RTA	11,175
84 x 38	P-Lam	1	67073/5RTA	10,795
84 x 42	Wood	1	67074/2RTA	11,320
84 x 42	P-Lam	1	67074/5RTA	10,945
96 x 42	Wood	1	67075/2RTA	11,740
96 x 42	P-Lam	1	67075/5RTA	11,350
96 x 48	Wood	1	67076/2RTA	13,160
96 x 48	P-Lam	1	67076/5RTA	12,705
108 x 42	Wood	2	67077/2RTA	12,980
108 x 42	P-Lam	2	67077/5RTA	12,535
108 x 48	Wood	2	67078/2RTA	14,580
108 x 48	P-Lam	2	67078/5RTA	14,070
120 x 42	Wood	2	67079/2RTA	14,225
120 x 42	P-Lam	2	67079/5RTA	13,730
120 x 48	Wood	2	67080/2RTA	16,005
120 x 48	P-Lam	2	67080/5RTA	15,435
120 x 54	Wood	2	67081/2RTA	17,780
120 x 54	P-Lam	2	67081/5RTA	17,145
132 x 48	Wood	2	67082/2RTA	17,420
132 x 48	P-Lam	2	67082/5RTA	16,795
132 x 54	Wood	2	67083/2RTA	19,380
132 x 54	P-Lam	2	67083/5RTA	18,675
144 x 48	Wood	2	67084/2RTA	18,845
144 x 48	P-Lam	2	67084/5RTA	18,165
144 x 54	Wood	2	67085/2RTA	20,975
144 x 54	P-Lam	2	67085/5RTA	20,210

HIGH CAPACITY WIRE PAN



*Wire pan can be retrofitted to any Una Conference table

MDL# 55060

List Price: \$1,185

The Cable Management Pan is designed to conceal large volumes of cabling, retractor mechanisms, and components for M and Double Sided Forums. Ideal for narrow-depth tables, this hinged metal pan provides a clean and efficient under-table solution to keep unsightly equipment hidden.

**Image shown for general reference- your specific pan may look different

Material: Powder-coated metal

Finish: Standard silver (custom color-matching available for an upcharge)

Application: Suitable for all Linear Una Conference tables

For more details contact customer service at **800.668.9318**.

Model # 67083/2AEA



Model # 67083/5AEA

132" x 54" Arc End Rectangle



Una CONFERENCE COLLECTION

RECTANGLE SHAPE

Design - modeus ID



Specify edge type; add the two letter code after the model number.



Reverse Bevel Edge (RB)



Facet Edge (FC)
not compatible with soft radius corner tops



Taper Edge (TE)



Flowform Edge (FF)
5% upcharge
laminated not available
not compatible with soft radius corner tops



Camber Edge (CE)
8" radius required for soft corner tops
5% upcharge
laminated not available

All Rectangular shape table sizes available with a 6" radius "Soft" corner (must be specified at time of order)

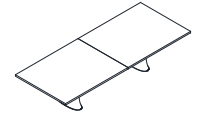

Una CONFERENCE 2 Fixed Bases 29" Table Height



Una CONFERENCE 2 Fixed Bases 38" Table Height



L" x D"	Top Finish	Top Sections	Model Number	List Price
72 x 36	Wood	1	67001/2RT	8,845
72 x 36	P-Lam	1	67001/5RT	8,490
78 x 38	Wood	1	67002/2RT	9,110
78 x 38	P-Lam	1	67002/5RT	8,750
84 x 38	Wood	1	67003/2RT	9,390
84 x 38	P-Lam	1	67003/5RT	9,010
84 x 42	Wood	1	67004/2RT	9,535
84 x 42	P-Lam	1	67004/5RT	9,160
96 x 42	Wood	1	67005/2RT	9,955
96 x 42	P-Lam	1	67005/5RT	9,565
96 x 48	Wood	1	67006/2RT	11,375
96 x 48	P-Lam	1	67006/5RT	10,920
108 x 42	Wood	2	67007/2RT	11,195
108 x 42	P-Lam	2	67007/5RT	10,750
108 x 48	Wood	2	67008/2RT	12,795
108 x 48	P-Lam	2	67008/5RT	12,285
120 x 42	Wood	2	67009/2RT	12,440
120 x 42	P-Lam	2	67009/5RT	11,945
120 x 48	Wood	2	67010/2RT	14,220
120 x 48	P-Lam	2	67010/5RT	13,650
120 x 54	Wood	2	67011/2RT	15,995
120 x 54	P-Lam	2	67011/5RT	15,360
132 x 48	Wood	2	67012/2RT	15,635
132 x 48	P-Lam	2	67012/5RT	15,010
132 x 54	Wood	2	67013/2RT	17,595
132 x 54	P-Lam	2	67013/5RT	16,890
144 x 48	Wood	2	67014/2RT	17,060
144 x 48	P-Lam	2	67014/5RT	16,380
144 x 54	Wood	2	67015/2RT	19,190
144 x 54	P-Lam	2	67015/5RT	18,425
144 x 60	Wood	2	67016/2RT	21,325
144 x 60	P-Lam	2	67016/5RT	20,470

L" x D"	Top Finish	Top Sections	Model Number	List Price
72 x 36	Wood	1	67036/2RT	9,110
72 x 36	P-Lam	1	67036/5RT	8,750
78 x 38	Wood	1	67037/2RT	9,390
78 x 38	P-Lam	1	67037/5RT	9,010
84 x 38	Wood	1	67038/2RT	9,675
84 x 38	P-Lam	1	67038/5RT	9,285
84 x 42	Wood	1	67039/2RT	9,825
84 x 42	P-Lam	1	67039/5RT	9,435
96 x 42	Wood	1	67040/2RT	10,255
96 x 42	P-Lam	1	67040/5RT	9,850
96 x 48	Wood	1	67041/2RT	11,715
96 x 48	P-Lam	1	67041/5RT	11,255
108 x 42	Wood	2	67042/2RT	11,530
108 x 42	P-Lam	2	67042/5RT	11,075
108 x 48	Wood	2	67043/2RT	13,185
108 x 48	P-Lam	2	67043/5RT	12,660
120 x 42	Wood	2	67044/2RT	12,820
120 x 42	P-Lam	2	67044/5RT	12,310
120 x 48	Wood	2	67045/2RT	14,650
120 x 48	P-Lam	2	67045/5RT	14,060
120 x 54	Wood	2	67046/2RT	16,475
120 x 54	P-Lam	2	67046/5RT	15,820
132 x 48	Wood	2	67047/2RT	16,110
132 x 48	P-Lam	2	67047/5RT	15,465
132 x 54	Wood	2	67048/2RT	18,125
132 x 54	P-Lam	2	67048/5RT	17,400
144 x 48	Wood	2	67049/2RT	17,575
144 x 48	P-Lam	2	67049/5RT	16,875
144 x 54	Wood	2	67050/2RT	19,770
144 x 54	P-Lam	2	67050/5RT	18,980
144 x 60	Wood	2	67051/2RT	21,965
144 x 60	P-Lam	2	67051/5RT	21,085

HIGH CAPACITY WIRE PAN

The Cable Management Pan is designed to conceal large volumes of cabling, retractor mechanisms, and components for M and Double Sided Forums. Ideal for narrow-depth tables, this hinged metal pan provides a clean and efficient under-table solution to keep unsightly equipment hidden.

**Image shown for general reference- your specific pan may look different

Material: Powder-coated metal

Finish: Standard silver (custom color-matching available for an upcharge)

Application: Suitable for all Linear Una Conference tables

*Wire pan can be retrofitted to any Una Conference table

MDL# 55060

List Price: \$1,185



For more details contact customer service at **800.668.9318**.

Una CONFERENCE COLLECTION

RECTANGLE SHAPE

Design - modeus ID



Specify edge type; add the two letter code after the model number.



Reverse Bevel Edge (RB)



Facet Edge (FC)
not compatible with soft radius corner tops



Taper Edge (TE)



Flowform Edge (FF)
5% upcharge
laminates not available
not compatible with soft radius corner tops



Camber Edge (CE)
8" radius required for soft corner tops
5% upcharge
laminates not available

All Rectangular shape table sizes available with a 6" radius "Soft" corner (must be specified at time of order)

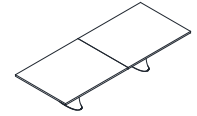

Una CONFERENCE 3 Fixed Bases 29" Table Height



Una CONFERENCE 4 Fixed Bases 29" Table Height



L" x D"	Top Finish	Top Sections	Model Number	List Price
156 48	Wood	2	67017/2RT	18,480
156 48	P-Lam	2	67017/5RT	17,745
156 54	Wood	2	67018/2RT	20,790
156 54	P-Lam	2	67018/5RT	19,965
156 60	Wood	2	67019/2RT	23,100
156 60	P-Lam	2	67019/5RT	22,180
168 48	Wood	2	67020/2RT	19,905
168 48	P-Lam	2	67020/5RT	19,110
168 54	Wood	2	67021/2RT	22,390
168 54	P-Lam	2	67021/5RT	21,495
168 60	Wood	2	67022/2RT	24,875
168 60	P-Lam	2	67022/5RT	23,885
180 48	Wood	3	67023/2RT	21,325
180 48	P-Lam	3	67023/5RT	20,470
180 54	Wood	3	67024/2RT	23,990
180 54	P-Lam	3	67024/5RT	23,035
180 60	Wood	3	67025/2RT	26,650
180 60	P-Lam	3	67025/5RT	25,320
192 54	Wood	3	67026/2RT	25,585
192 54	P-Lam	3	67026/5RT	24,565
192 60	Wood	3	67027/2RT	28,430
192 60	P-Lam	3	67027/5RT	27,295
204 54	Wood	3	67028/2RT	27,185
204 54	P-Lam	3	67028/5RT	26,100
204 60	Wood	3	67029/2RT	30,205
204 60	P-Lam	3	67029/5RT	28,695
216 54	Wood	3	67030/2RT	28,790
216 54	P-Lam	3	67030/5RT	27,640
216 60	Wood	3	67031/2RT	31,985
216 60	P-Lam	3	67031/5RT	30,710

L" x D"	Top Finish	Top Sections	Model Number	List Price
228 54	Wood	3	67032/2RT	30,385
228 54	P-Lam	3	67032/5RT	29,170
228 60	Wood	3	67033/2RT	33,760
228 60	P-Lam	3	67033/5RT	32,410
240 54	Wood	3	67034/2RT	31,985
240 54	P-Lam	3	67034/5RT	30,710
240 60	Wood	3	67035/2RT	35,535
240 60	P-Lam	3	67035/5RT	34,115

Model # 67048/2AE

132" x 54" Arc End Rectangle



Una CONFERENCE COLLECTION

RECTANGLE SHAPE

Design - modeus ID



Specify edge type; add the two letter code after the model number.

All Rectangular shape table sizes available with a 6" radius "Soft" corner (must be specified at time of order)



Reverse Bevel Edge (RB)



Facet Edge (FC)
not compatible with soft radius corner tops



Taper Edge (TE)



Flowform Edge (FF)
5% upcharge
laminates not available
not compatible with soft radius corner tops



Camber Edge (CE)
8" radius required for soft corner tops
5% upcharge
laminates not available

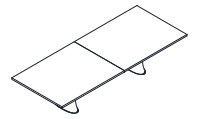

Una CONFERENCE 3 Fixed Bases 38" Table Height



Una CONFERENCE 4 Fixed Bases 38" Table Height



L" x D"	Top Finish	Top Sections	Model Number	List Price
156 48	Wood	2	67052/2RT	19,040
156 48	P-Lam	2	67052/5RT	18,285
156 54	Wood	2	67053/2RT	21,415
156 54	P-Lam	2	67053/5RT	20,565
156 60	Wood	2	67054/2RT	23,795
156 60	P-Lam	2	67054/5RT	22,845
168 48	Wood	2	67055/2RT	20,505
168 48	P-Lam	2	67055/5RT	19,690
168 54	Wood	2	67056/2RT	23,060
168 54	P-Lam	2	67056/5RT	22,140
168 60	Wood	2	67057/2RT	25,630
168 60	P-Lam	2	67057/5RT	24,605
180 48	Wood	3	67058/2RT	21,965
180 48	P-Lam	3	67058/5RT	21,085
180 54	Wood	3	67059/2RT	24,715
180 54	P-Lam	3	67059/5RT	23,725
180 60	Wood	3	67060/2RT	27,455
180 60	P-Lam	3	67060/5RT	26,085
192 54	Wood	3	67061/2RT	26,355
192 54	P-Lam	3	67061/5RT	25,305
192 60	Wood	3	67062/2RT	29,285
192 60	P-Lam	3	67062/5RT	28,115
204 54	Wood	3	67063/2RT	28,005
204 54	P-Lam	3	67063/5RT	26,890
204 60	Wood	3	67064/2RT	31,115
204 60	P-Lam	3	67064/5RT	29,870
216 54	Wood	3	67065/2RT	29,655
216 54	P-Lam	3	67065/5RT	28,470
216 60	Wood	3	67066/2RT	32,945
216 60	P-Lam	3	67066/5RT	31,635

L" x D"	Top Finish	Top Sections	Model Number	List Price
228 54	Wood	3	67067/2RT	31,300
228 54	P-Lam	3	67067/5RT	30,050
228 60	Wood	3	67068/2RT	34,775
228 60	P-Lam	3	67068/5RT	33,385
240 54	Wood	3	67069/2RT	32,945
240 54	P-Lam	3	67069/5RT	31,635
240 60	Wood	3	67070/2RT	36,605
240 60	P-Lam	3	67070/5RT	35,140

Una CONFERENCE COLLECTION

BOAT SHAPE

Design - modeus ID



Specify edge type; add the two letter code after the model number.

All Boat shape table sizes available with a 6" radius "Soft" corner (must be specified at time of order)



Reverse Bevel Edge (RB)



Facet Edge (FC) not compatible with soft radius corner tops



Taper Edge (TE)



Flowform Edge (FF) long edges only 5% upcharge laminate not available not compatible with soft radius corner tops



Camber Edge (CE) 8" radius required for soft corner tops 5% upcharge laminate not available

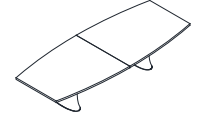

Una CONFERENCE 2 Height Adjustable Bases Table Height 28½" - 38"



L" x D"	Top Finish	Top Sections	Model Number	List Price
72 x 36	Wood	1	67071/2BTA	10,835
72 x 36	P-Lam	1	67071/5BTA	10,740
78 x 38	Wood	1	67072/2BTA	11,105
78 x 38	P-Lam	1	67072/5BTA	11,010
84 x 38	Wood	1	67073/2BTA	11,390
84 x 38	P-Lam	1	67073/5BTA	11,290
84 x 42	Wood	1	67074/2BTA	11,815
84 x 42	P-Lam	1	67074/5BTA	11,415
96 x 42	Wood	1	67075/2BTA	12,235
96 x 42	P-Lam	1	67075/5BTA	11,820
96 x 48	Wood	1	67076/2BTA	13,730
96 x 48	P-Lam	1	67076/5BTA	13,255
108 x 42	Wood	2	67077/2BTA	13,545
108 x 42	P-Lam	2	67077/5BTA	13,080
108 x 48	Wood	2	67078/2BTA	15,220
108 x 48	P-Lam	2	67078/5BTA	14,685
120 x 42	Wood	2	67079/2BTA	14,850
120 x 42	P-Lam	2	67079/5BTA	14,330
120 x 48	Wood	2	67080/2BTA	16,715
120 x 48	P-Lam	2	67080/5BTA	16,120
120 x 54	Wood	2	67081/2BTA	18,575
120 x 54	P-Lam	2	67081/5BTA	17,910
132 x 48	Wood	2	67082/2BTA	18,210
132 x 48	P-Lam	2	67082/5BTA	17,555
132 x 54	Wood	2	67083/2BTA	20,260
132 x 54	P-Lam	2	67083/5BTA	19,525
144 x 48	Wood	2	67084/2BTA	19,700
144 x 48	P-Lam	2	67084/5BTA	18,985
144 x 54	Wood	2	67085/2BTA	21,940
144 x 54	P-Lam	2	67085/5BTA	21,140

HIGH CAPACITY WIRE PAN



*Wire pan can be retrofitted to any Una Conference table

MDL# 55060

List Price: \$1,185

The Cable Management Pan is designed to conceal large volumes of cabling, retractor mechanisms, and components for M and Double Sided Forums. Ideal for narrow-depth tables, this hinged metal pan provides a clean and efficient under-table solution to keep unsightly equipment hidden.

**Image shown for general reference- your specific pan may look different

Material: Powder-coated metal

Finish: Standard silver (custom color-matching available for an upcharge)

Application: Suitable for all Linear Una Conference tables

For more details contact customer service at **800.668.9318**.

Model # 67083/2AEA



Model # 67083/5AEA

132" x 54" Arc End Rectangle



Una CONFERENCE COLLECTION

BOAT SHAPE Design - modeus ID



Specify edge type; add the two letter code after the model number.

All Boat shape table sizes available with a 6" radius "Soft" corner (must be specified at time of order)



Reverse Bevel Edge (RB)



Facet Edge (FC)
not compatible with soft radius corner tops



Taper Edge (TE)



Flowform Edge (FF)
long edges only
5% upcharge
laminata not available
not compatible with soft radius corner tops



Camber Edge (CE)
8" radius required for soft corner tops
5% upcharge
laminata not available

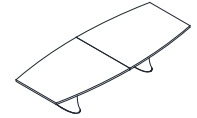

Una CONFERENCE
2 Fixed Bases
29" Table Height



Una CONFERENCE
2 Fixed Bases
38" Table Height



L" x D"	Top Finish	Top Sections	Model Number	List Price
72 x 36	Wood	1	67001/2BT	9,050
72 x 36	P-Lam	1	67001/5BT	8,955
78 x 38	Wood	1	67002/2BT	9,320
78 x 38	P-Lam	1	67002/5BT	9,225
84 x 38	Wood	1	67003/2BT	9,605
84 x 38	P-Lam	1	67003/5BT	9,505
84 x 42	Wood	1	67004/2BT	10,030
84 x 42	P-Lam	1	67004/5BT	9,630
96 x 42	Wood	1	67005/2BT	10,450
96 x 42	P-Lam	1	67005/5BT	10,035
96 x 48	Wood	1	67006/2BT	11,945
96 x 48	P-Lam	1	67006/5BT	11,470
108 x 42	Wood	2	67007/2BT	11,760
108 x 42	P-Lam	2	67007/5BT	11,295
108 x 48	Wood	2	67008/2BT	13,435
108 x 48	P-Lam	2	67008/5BT	12,900
120 x 42	Wood	2	67009/2BT	13,065
120 x 42	P-Lam	2	67009/5BT	12,545
120 x 48	Wood	2	67010/2BT	14,930
120 x 48	P-Lam	2	67010/5BT	14,335
120 x 54	Wood	2	67011/2BT	16,790
120 x 54	P-Lam	2	67011/5BT	16,125
132 x 48	Wood	2	67012/2BT	16,425
132 x 48	P-Lam	2	67012/5BT	15,770
132 x 54	Wood	2	67013/2BT	18,475
132 x 54	P-Lam	2	67013/5BT	17,740
144 x 48	Wood	2	67014/2BT	17,915
144 x 48	P-Lam	2	67014/5BT	17,200
144 x 54	Wood	2	67015/2BT	20,155
144 x 54	P-Lam	2	67015/5BT	19,355
144 x 60	Wood	2	67016/2BT	22,390
144 x 60	P-Lam	2	67016/5BT	21,495

L" x D"	Top Finish	Top Sections	Model Number	List Price
72 x 36	Wood	1	67036/2BT	9,320
72 x 36	P-Lam	1	67036/5BT	9,225
78 x 38	Wood	1	67037/2BT	9,605
78 x 38	P-Lam	1	67037/5BT	9,505
84 x 38	Wood	1	67038/2BT	9,895
84 x 38	P-Lam	1	67038/5BT	9,795
84 x 42	Wood	1	67039/2BT	10,335
84 x 42	P-Lam	1	67039/5BT	9,925
96 x 42	Wood	1	67040/2BT	10,765
96 x 42	P-Lam	1	67040/5BT	10,340
96 x 48	Wood	1	67041/2BT	12,310
96 x 48	P-Lam	1	67041/5BT	11,815
108 x 42	Wood	2	67042/2BT	12,120
108 x 42	P-Lam	2	67042/5BT	11,635
108 x 48	Wood	2	67043/2BT	13,840
108 x 48	P-Lam	2	67043/5BT	13,290
120 x 42	Wood	2	67044/2BT	13,460
120 x 42	P-Lam	2	67044/5BT	12,925
120 x 48	Wood	2	67045/2BT	15,380
120 x 48	P-Lam	2	67045/5BT	14,765
120 x 54	Wood	2	67046/2BT	17,295
120 x 54	P-Lam	2	67046/5BT	16,615
132 x 48	Wood	2	67047/2BT	16,920
132 x 48	P-Lam	2	67047/5BT	16,245
132 x 54	Wood	2	67048/2BT	19,035
132 x 54	P-Lam	2	67048/5BT	18,280
144 x 48	Wood	2	67049/2BT	18,455
144 x 48	P-Lam	2	67049/5BT	17,720
144 x 54	Wood	2	67050/2BT	20,765
144 x 54	P-Lam	2	67050/5BT	19,935
144 x 60	Wood	2	67051/2BT	23,060
144 x 60	P-Lam	2	67051/5BT	22,140

HIGH CAPACITY WIRE PAN

The Cable Management Pan is designed to conceal large volumes of cabling, retractor mechanisms, and components for M and Double Sided Forums. Ideal for narrow-depth tables, this hinged metal pan provides a clean and efficient under-table solution to keep unsightly equipment hidden.

**Image shown for general reference- your specific pan may look different.

Material: Powder-coated metal
Finish: Standard silver (custom color-matching available for an upcharge)
Application: Suitable for all Linear Una Conference tables

*Wire pan can be retrofitted to any Una Conference table

MDL# 55060
List Price: \$1,185



For more details contact customer service at 800.668.9318.

Una CONFERENCE COLLECTION

BOAT SHAPE

Design - modeus ID



Specify edge type; add the two letter code after the model number.



Reverse Bevel Edge (RB)



Facet Edge (FC)
not compatible with soft radius corner tops



Taper Edge (TE)



Flowform Edge (FF)
long edges only
5% upcharge
laminates not available
not compatible with soft radius corner tops



Camber Edge (CE)
8" radius required for soft corner tops
5% upcharge
laminates not available

All Boat shape table sizes available with a 6" radius "Soft" corner (must be specified at time of order)

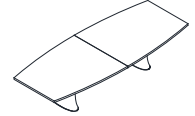

Una CONFERENCE 3 Fixed Bases 29" Table Height



Una CONFERENCE 4 Fixed Bases 29" Table Height



L" x D"	Top Finish	Top Sections	Model Number	List Price
156 48	Wood	2	67017/2BT	16,935
156 48	P-Lam	2	67017/5BT	16,255
156 54	Wood	2	67018/2BT	19,045
156 54	P-Lam	2	67018/5BT	18,285
156 60	Wood	2	67019/2BT	21,160
156 60	P-Lam	2	67019/5BT	20,315
168 48	Wood	2	67020/2BT	18,230
168 48	P-Lam	2	67020/5BT	17,505
168 54	Wood	2	67021/2BT	20,510
168 54	P-Lam	2	67021/5BT	19,690
168 60	Wood	2	67022/2BT	22,785
168 60	P-Lam	2	67022/5BT	21,880
180 48	Wood	3	67023/2BT	22,390
180 48	P-Lam	3	67023/5BT	21,495
180 54	Wood	3	67024/2BT	25,185
180 54	P-Lam	3	67024/5BT	24,185
180 60	Wood	3	67025/2BT	27,985
180 60	P-Lam	3	67025/5BT	26,865
192 54	Wood	3	67026/2BT	23,445
192 54	P-Lam	3	67026/5BT	22,510
192 60	Wood	3	67027/2BT	26,040
192 60	P-Lam	3	67027/5BT	25,005
204 54	Wood	3	67028/2BT	35,825
204 54	P-Lam	3	67028/5BT	34,395
204 60	Wood	3	67029/2BT	28,545
204 60	P-Lam	3	67029/5BT	27,405
216 54	Wood	3	67030/2BT	30,225
216 54	P-Lam	3	67030/5BT	29,020
216 60	Wood	3	67031/2BT	33,580
216 60	P-Lam	3	67031/5BT	32,245

L" x D"	Top Finish	Top Sections	Model Number	List Price
228 54	Wood	3	67032/2BT	31,905
228 54	P-Lam	3	67032/5BT	30,630
228 60	Wood	3	67033/2BT	35,450
228 60	P-Lam	3	67033/5BT	34,035
240 54	Wood	3	67034/2BT	33,580
240 54	P-Lam	3	67034/5BT	32,245
240 60	Wood	3	67035/2BT	37,315
240 60	P-Lam	3	67035/5BT	35,825

Model # 67048/2AE

132" x 54" Arc End Rectangle



Una CONFERENCE COLLECTION

BOAT SHAPE

Design - modeus ID



Specify edge type; add the two letter code after the model number.



Reverse Bevel Edge (RB)



Facet Edge (FC)
not compatible with soft radius corner tops



Taper Edge (TE)



Flowform Edge (FF)
long edges only
5% upcharge
laminates not available
not compatible with soft radius corner tops



Camber Edge (CE)
8" radius required for soft corner tops
5% upcharge
laminates not available

All Boat shape table sizes available with a 6" radius "Soft" corner (must be specified at time of order)

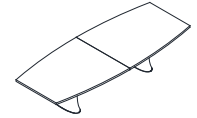

Una CONFERENCE 3 Fixed Bases 38" Table Height



Una CONFERENCE 4 Fixed Bases 38" Table Height



L" x D"	Top Finish	Top Sections	Model Number	List Price
156 48	Wood	2	67052/2BT	17,445
156 48	P-Lam	2	67052/5BT	16,745
156 54	Wood	2	67053/2BT	19,615
156 54	P-Lam	2	67053/5BT	18,835
156 60	Wood	2	67054/2BT	21,795
156 60	P-Lam	2	67054/5BT	20,930
168 48	Wood	2	67055/2BT	18,780
168 48	P-Lam	2	67055/5BT	18,035
168 54	Wood	2	67056/2BT	21,130
168 54	P-Lam	2	67056/5BT	20,285
168 60	Wood	2	67057/2BT	23,475
168 60	P-Lam	2	67057/5BT	22,540
180 48	Wood	3	67058/2BT	23,060
180 48	P-Lam	3	67058/5BT	22,140
180 54	Wood	3	67059/2BT	25,945
180 54	P-Lam	3	67059/5BT	24,915
180 60	Wood	3	67060/2BT	28,825
180 60	P-Lam	3	67060/5BT	27,675
192 54	Wood	3	67061/2BT	24,145
192 54	P-Lam	3	67061/5BT	23,185
192 60	Wood	3	67062/2BT	26,825
192 60	P-Lam	3	67062/5BT	25,755
204 54	Wood	3	67063/2BT	36,900
204 54	P-Lam	3	67063/5BT	35,430
204 60	Wood	3	67064/2BT	29,410
204 60	P-Lam	3	67064/5BT	28,230
216 54	Wood	3	67065/2BT	31,135
216 54	P-Lam	3	67065/5BT	29,890
216 60	Wood	3	67066/2BT	34,590
216 60	P-Lam	3	67066/5BT	33,215

L" x D"	Top Finish	Top Sections	Model Number	List Price
228 54	Wood	3	67067/2BT	32,865
228 54	P-Lam	3	67067/5BT	31,555
228 60	Wood	3	67068/2BT	36,515
228 60	P-Lam	3	67068/5BT	35,055
240 54	Wood	3	67069/2BT	34,590
240 54	P-Lam	3	67069/5BT	33,215
240 60	Wood	3	67070/2BT	38,440
240 60	P-Lam	3	67070/5BT	36,900

Una CONFERENCE COLLECTION

SUPER ELLIPSE SHAPE Design - modeus ID



Specify edge type; add the two letter code after the model number.



Reverse Bevel Edge (RB)



Facet Edge (FC)



Taper Edge (TE)



Flowform Edge (FF)
5% upcharge
laminates not available



Camber Edge (CE)
5% upcharge
laminates not available

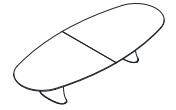

Una CONFERENCE
2 Height Adjustable Bases
Table Height 28½" - 38"



L" x D"	Top Finish	Top Sections	Model Number	List Price
72 x 36	Wood	1	67071/2SEA	11,595
72 x 36	P-Lam	1	67071/5SEA	11,205
78 x 38	Wood	1	67072/2SEA	11,895
78 x 38	P-Lam	1	67072/5SEA	11,490
84 x 38	Wood	1	67073/2SEA	12,200
84 x 38	P-Lam	1	67073/5SEA	11,785
84 x 42	Wood	1	67074/2SEA	12,315
84 x 42	P-Lam	1	67074/5SEA	11,895
96 x 42	Wood	1	67075/2SEA	12,735
96 x 42	P-Lam	1	67075/5SEA	12,300
96 x 48	Wood	1	67076/2SEA	14,300
96 x 48	P-Lam	1	67076/5SEA	13,800
108 x 42	Wood	2	67077/2SEA	14,105
108 x 42	P-Lam	2	67077/5SEA	13,615
108 x 48	Wood	2	67078/2SEA	15,865
108 x 48	P-Lam	2	67078/5SEA	15,300
120 x 42	Wood	2	67079/2SEA	15,470
120 x 42	P-Lam	2	67079/5SEA	14,925
120 x 48	Wood	2	67080/2SEA	17,420
120 x 48	P-Lam	2	67080/5SEA	16,795
120 x 54	Wood	2	67081/2SEA	19,380
120 x 54	P-Lam	2	67081/5SEA	18,675
132 x 48	Wood	2	67082/2SEA	18,985
132 x 48	P-Lam	2	67082/5SEA	18,300
132 x 54	Wood	2	67083/2SEA	21,140
132 x 54	P-Lam	2	67083/5SEA	20,365
144 x 48	Wood	2	67084/2SEA	20,550
144 x 48	P-Lam	2	67084/5SEA	19,805
144 x 54	Wood	2	67085/2SEA	22,900
144 x 54	P-Lam	2	67085/5SEA	22,060

HIGH CAPACITY WIRE PAN



*Wire pan can be retrofitted to any Una Conference table

MDL# 55060

List Price: \$1,185

The Cable Management Pan is designed to conceal large volumes of cabling, retractor mechanisms, and components for M and Double Sided Forums. Ideal for narrow-depth tables, this hinged metal pan provides a clean and efficient under-table solution to keep unsightly equipment hidden.

**Image shown for general reference- your specific pan may look different

Material: Powder-coated metal

Finish: Standard silver (custom color-matching available for an upcharge)

Application: Suitable for all Linear Una Conference tables

For more details contact customer service at **800.668.9318**.

Model # 67083/2AEA



Model # 67083/5AEA

132" x 54" Arc End Rectangle



Una CONFERENCE COLLECTION

SUPER ELLIPSE SHAPE Design - modeus ID



Specify edge type; add the two letter code after the model number.



Reverse Bevel Edge (RB)



Facet Edge (FC)



Taper Edge (TE)



Flowform Edge (FF)
5% upcharge
laminates not available



Camber Edge (CE)
5% upcharge
laminates not available

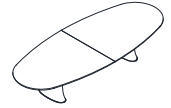

Una CONFERENCE 2 Fixed Bases 29" Table Height



Una CONFERENCE 2 Fixed Bases 38" Table Height



L" x D"	Top Finish	Top Sections	Model Number	List Price
72 x 36	Wood	1	67001/2SE	9,810
72 x 36	P-Lam	1	67001/5SE	9,420
78 x 38	Wood	1	67002/2SE	10,110
78 x 38	P-Lam	1	67002/5SE	9,705
84 x 38	Wood	1	67003/2SE	10,415
84 x 38	P-Lam	1	67003/5SE	10,000
84 x 42	Wood	1	67004/2SE	10,530
84 x 42	P-Lam	1	67004/5SE	10,110
96 x 42	Wood	1	67005/2SE	10,950
96 x 42	P-Lam	1	67005/5SE	10,515
96 x 48	Wood	1	67006/2SE	12,515
96 x 48	P-Lam	1	67006/5SE	12,015
108 x 42	Wood	2	67007/2SE	12,320
108 x 42	P-Lam	2	67007/5SE	11,830
108 x 48	Wood	2	67008/2SE	14,080
108 x 48	P-Lam	2	67008/5SE	13,515
120 x 42	Wood	2	67009/2SE	13,685
120 x 42	P-Lam	2	67009/5SE	13,140
120 x 48	Wood	2	67010/2SE	15,635
120 x 48	P-Lam	2	67010/5SE	15,010
120 x 54	Wood	2	67011/2SE	17,595
120 x 54	P-Lam	2	67011/5SE	16,890
132 x 48	Wood	2	67012/2SE	17,200
132 x 48	P-Lam	2	67012/5SE	16,515
132 x 54	Wood	2	67013/2SE	19,355
132 x 54	P-Lam	2	67013/5SE	18,580
144 x 48	Wood	2	67014/2SE	18,765
144 x 48	P-Lam	2	67014/5SE	18,020
144 x 54	Wood	2	67015/2SE	21,115
144 x 54	P-Lam	2	67015/5SE	20,275
144 x 60	Wood	2	67016/2SE	23,455
144 x 60	P-Lam	2	67016/5SE	22,520

L" x D"	Top Finish	Top Sections	Model Number	List Price
72 x 36	Wood	1	67036/2SE	10,110
72 x 36	P-Lam	1	67036/5SE	9,705
78 x 38	Wood	1	67037/2SE	10,415
78 x 38	P-Lam	1	67037/5SE	10,000
84 x 38	Wood	1	67038/2SE	10,730
84 x 38	P-Lam	1	67038/5SE	10,305
84 x 42	Wood	1	67039/2SE	10,850
84 x 42	P-Lam	1	67039/5SE	10,415
96 x 42	Wood	1	67040/2SE	11,280
96 x 42	P-Lam	1	67040/5SE	10,835
96 x 48	Wood	1	67041/2SE	12,890
96 x 48	P-Lam	1	67041/5SE	12,375
108 x 42	Wood	2	67042/2SE	12,690
108 x 42	P-Lam	2	67042/5SE	12,190
108 x 48	Wood	2	67043/2SE	14,505
108 x 48	P-Lam	2	67043/5SE	13,925
120 x 42	Wood	2	67044/2SE	14,100
120 x 42	P-Lam	2	67044/5SE	13,535
120 x 48	Wood	2	67045/2SE	16,110
120 x 48	P-Lam	2	67045/5SE	15,465
120 x 54	Wood	2	67046/2SE	18,125
120 x 54	P-Lam	2	67046/5SE	17,400
132 x 48	Wood	2	67047/2SE	17,720
132 x 48	P-Lam	2	67047/5SE	17,010
132 x 54	Wood	2	67048/2SE	19,935
132 x 54	P-Lam	2	67048/5SE	19,145
144 x 48	Wood	2	67049/2SE	19,335
144 x 48	P-Lam	2	67049/5SE	18,560
144 x 54	Wood	2	67050/2SE	21,750
144 x 54	P-Lam	2	67050/5SE	20,880
144 x 60	Wood	2	67051/2SE	24,165
144 x 60	P-Lam	2	67051/5SE	23,195

HIGH CAPACITY WIRE PAN

The Cable Management Pan is designed to conceal large volumes of cabling, retractor mechanisms, and components for M and Double Sided Forums. Ideal for narrow-depth tables, this hinged metal pan provides a clean and efficient under-table solution to keep unsightly equipment hidden.

**Image shown for general reference- your specific pan may look different.

Material: Powder-coated metal

Finish: Standard silver (custom color-matching available for an upcharge)

Application: Suitable for all Linear Una Conference tables

*Wire pan can be retrofitted to any Una Conference table

MDL# 55060

List Price: \$1,185



For more details contact customer service at 800.668.9318.

Una CONFERENCE COLLECTION

SUPER ELLIPSE SHAPE Design - modeus ID



Specify edge type; add the two letter code after the model number.



Reverse Bevel Edge (RB)



Facet Edge (FC)



Taper Edge (TE)



Flowform Edge (FF)
5% upcharge
laminite not available



Camber Edge (CE)
5% upcharge
laminite not available

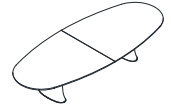

Una CONFERENCE 3 Fixed Bases 29" Table Height



Una CONFERENCE 4 Fixed Bases 29" Table Height



L" x D"	Top Finish	Top Sections	Model Number	List Price
156 48	Wood	2	67017/2SE	20,330
156 48	P-Lam	2	67017/5SE	19,520
156 54	Wood	2	67018/2SE	22,870
156 54	P-Lam	2	67018/5SE	21,960
156 60	Wood	2	67019/2SE	25,410
156 60	P-Lam	2	67019/5SE	24,400
168 48	Wood	2	67020/2SE	21,895
168 48	P-Lam	2	67020/5SE	21,025
168 54	Wood	2	67021/2SE	24,630
168 54	P-Lam	2	67021/5SE	23,650
168 60	Wood	2	67022/2SE	27,365
168 60	P-Lam	2	67022/5SE	26,275
180 48	Wood	3	67023/2SE	23,455
180 48	P-Lam	3	67023/5SE	22,520
180 54	Wood	3	67024/2SE	26,390
180 54	P-Lam	3	67024/5SE	25,335
180 60	Wood	3	67025/2SE	29,320
180 60	P-Lam	3	67025/5SE	27,855
192 54	Wood	3	67026/2SE	28,150
192 54	P-Lam	3	67026/5SE	27,025
192 60	Wood	3	67027/2SE	31,270
192 60	P-Lam	3	67027/5SE	30,020
204 54	Wood	3	67028/2SE	37,530
204 54	P-Lam	3	67028/5SE	36,035
204 60	Wood	3	67029/2SE	29,905
204 60	P-Lam	3	67029/5SE	28,715
216 54	Wood	3	67030/2SE	31,670
216 54	P-Lam	3	67030/5SE	30,405
216 60	Wood	3	67031/2SE	35,185
216 60	P-Lam	3	67031/5SE	33,775

L" x D"	Top Finish	Top Sections	Model Number	List Price
228 54	Wood	3	67032/2SE	33,425
228 54	P-Lam	3	67032/5SE	32,090
228 60	Wood	3	67033/2SE	37,135
228 60	P-Lam	3	67033/5SE	35,655
240 54	Wood	3	67034/2SE	35,185
240 54	P-Lam	3	67034/5SE	33,775
240 60	Wood	3	67035/2SE	39,090
240 60	P-Lam	3	67035/5SE	37,530

Model # 67048/2AE

132" x 54" Arc End Rectangle



Una CONFERENCE COLLECTION

SUPER ELLIPSE SHAPE Design - modeus ID



Specify edge type; add the two letter code after the model number.



Reverse Bevel Edge (RB)



Facet Edge (FC)



Taper Edge (TE)



Flowform Edge (FF)
5% upcharge
laminates not available



Camber Edge (CE)
5% upcharge
laminates not available

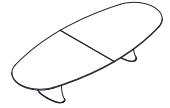

Una CONFERENCE 3 Fixed Bases 38" Table Height



Una CONFERENCE 4 Fixed Bases 38" Table Height



L" x D"	Top Finish	Top Sections	Model Number	List Price
156 48	Wood	2	67052/2SE	20,945
156 48	P-Lam	2	67052/5SE	20,110
156 54	Wood	2	67053/2SE	23,560
156 54	P-Lam	2	67053/5SE	22,620
156 60	Wood	2	67054/2SE	26,180
156 60	P-Lam	2	67054/5SE	25,135
168 48	Wood	2	67055/2SE	22,555
168 48	P-Lam	2	67055/5SE	21,660
168 54	Wood	2	67056/2SE	25,370
168 54	P-Lam	2	67056/5SE	24,360
168 60	Wood	2	67057/2SE	28,190
168 60	P-Lam	2	67057/5SE	27,065
180 48	Wood	3	67058/2SE	24,165
180 48	P-Lam	3	67058/5SE	23,195
180 54	Wood	3	67059/2SE	27,180
180 54	P-Lam	3	67059/5SE	26,095
180 60	Wood	3	67060/2SE	30,200
180 60	P-Lam	3	67060/5SE	28,695
192 54	Wood	3	67061/2SE	28,995
192 54	P-Lam	3	67061/5SE	27,840
192 60	Wood	3	67062/2SE	32,210
192 60	P-Lam	3	67062/5SE	30,925
204 54	Wood	3	67063/2SE	38,660
204 54	P-Lam	3	67063/5SE	37,115
204 60	Wood	3	67064/2SE	30,805
204 60	P-Lam	3	67064/5SE	29,580
216 54	Wood	3	67065/2SE	32,620
216 54	P-Lam	3	67065/5SE	31,320
216 60	Wood	3	67066/2SE	36,245
216 60	P-Lam	3	67066/5SE	34,790

L" x D"	Top Finish	Top Sections	Model Number	List Price
228 54	Wood	3	67067/2SE	34,425
228 54	P-Lam	3	67067/5SE	33,055
228 60	Wood	3	67068/2SE	38,255
228 60	P-Lam	3	67068/5SE	36,725
240 54	Wood	3	67069/2SE	36,245
240 54	P-Lam	3	67069/5SE	34,790
240 60	Wood	3	67070/2SE	40,265
240 60	P-Lam	3	67070/5SE	38,660

Una CONFERENCE COLLECTION

SUPER ELLIPSE SHAPE Design - modeus ID



Specify edge type; add the two letter code after the model number.



Reverse Bevel Edge (RB)



Facet Edge (FC)



Taper Edge (TE)



Flowform Edge (FF)
5% upcharge
laminates not available



Camber Edge (CE)
5% upcharge
laminates not available

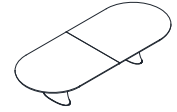

Una CONFERENCE
2 Height Adjustable Bases
Table Height 28½" - 38"



L" x D"	Top Finish	Top Sections	Model Number	List Price
72 x 36	Wood	1	67071/2RKA	11,355
72 x 36	P-Lam	1	67071/5RKA	10,975
78 x 38	Wood	1	67072/2RKA	11,640
78 x 38	P-Lam	1	67072/5RKA	11,255
84 x 38	Wood	1	67073/2RKA	11,940
84 x 38	P-Lam	1	67073/5RKA	11,540
84 x 42	Wood	1	67074/2RKA	12,065
84 x 42	P-Lam	1	67074/5RKA	11,655
96 x 42	Wood	1	67075/2RKA	12,485
96 x 42	P-Lam	1	67075/5RKA	12,060
96 x 48	Wood	1	67076/2RKA	14,015
96 x 48	P-Lam	1	67076/5RKA	13,525
108 x 42	Wood	2	67077/2RKA	13,825
108 x 42	P-Lam	2	67077/5RKA	13,350
108 x 48	Wood	2	67078/2RKA	15,540
108 x 48	P-Lam	2	67078/5RKA	14,995
120 x 42	Wood	2	67079/2RKA	15,160
120 x 42	P-Lam	2	67079/5RKA	14,630
120 x 48	Wood	2	67080/2RKA	17,070
120 x 48	P-Lam	2	67080/5RKA	16,460
120 x 54	Wood	2	67081/2RKA	18,980
120 x 54	P-Lam	2	67081/5RKA	18,295
132 x 48	Wood	2	67082/2RKA	18,600
132 x 48	P-Lam	2	67082/5RKA	17,925
132 x 54	Wood	2	67083/2RKA	20,705
132 x 54	P-Lam	2	67083/5RKA	19,945
144 x 48	Wood	2	67084/2RKA	20,130
144 x 48	P-Lam	2	67084/5RKA	19,400
144 x 54	Wood	2	67085/2RKA	22,420
144 x 54	P-Lam	2	67085/5RKA	21,595

HIGH CAPACITY WIRE PAN



*Wire pan can be retrofitted to any Una Conference table

MDL# 55060

List Price: \$1,185

The Cable Management Pan is designed to conceal large volumes of cabling, retractor mechanisms, and components for M and Double Sided Forums. Ideal for narrow-depth tables, this hinged metal pan provides a clean and efficient under-table solution to keep unsightly equipment hidden.

**Image shown for general reference- your specific pan may look different

Material: Powder-coated metal

Finish: Standard silver (custom color-matching available for an upcharge)

Application: Suitable for all Linear Una Conference tables

For more details contact customer service at **800.668.9318**.

Model # 67083/2AEA



Model # 67083/5AEA

132" x 54" Arc End Rectangle



Una CONFERENCE COLLECTION

RACETRACK SHAPE

Design - modeus ID



Specify edge type; add the two letter code after the model number.



Reverse Bevel Edge (RB)



Facet Edge (FC)



Taper Edge (TE)



Flowform Edge (FF)
5% upcharge
laminates not available



Camber Edge (CE)
5% upcharge
laminates not available

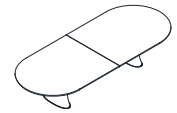

Una CONFERENCE 2 Fixed Bases 29" Table Height



Una CONFERENCE 2 Fixed Bases 38" Table Height



L" x D"	Top Finish	Top Sections	Model Number	List Price
72 x 36	Wood	1	67001/2RK	9,570
72 x 36	P-Lam	1	67001/5RK	9,190
78 x 38	Wood	1	67002/2RK	9,855
78 x 38	P-Lam	1	67002/5RK	9,470
84 x 38	Wood	1	67003/2RK	10,155
84 x 38	P-Lam	1	67003/5RK	9,755
84 x 42	Wood	1	67004/2RK	10,280
84 x 42	P-Lam	1	67004/5RK	9,870
96 x 42	Wood	1	67005/2RK	10,700
96 x 42	P-Lam	1	67005/5RK	10,275
96 x 48	Wood	1	67006/2RK	12,230
96 x 48	P-Lam	1	67006/5RK	11,740
108 x 42	Wood	2	67007/2RK	12,040
108 x 42	P-Lam	2	67007/5RK	11,565
108 x 48	Wood	2	67008/2RK	13,755
108 x 48	P-Lam	2	67008/5RK	13,210
120 x 42	Wood	2	67009/2RK	13,375
120 x 42	P-Lam	2	67009/5RK	12,845
120 x 48	Wood	2	67010/2RK	15,285
120 x 48	P-Lam	2	67010/5RK	14,675
120 x 54	Wood	2	67011/2RK	17,195
120 x 54	P-Lam	2	67011/5RK	16,510
132 x 48	Wood	2	67012/2RK	16,815
132 x 48	P-Lam	2	67012/5RK	16,140
132 x 54	Wood	2	67013/2RK	18,920
132 x 54	P-Lam	2	67013/5RK	18,160
144 x 48	Wood	2	67014/2RK	18,345
144 x 48	P-Lam	2	67014/5RK	17,615
144 x 54	Wood	2	67015/2RK	20,635
144 x 54	P-Lam	2	67015/5RK	19,810
144 x 60	Wood	2	67016/2RK	22,925
144 x 60	P-Lam	2	67016/5RK	22,010

L" x D"	Top Finish	Top Sections	Model Number	List Price
72 x 36	Wood	1	67036/2RK	9,855
72 x 36	P-Lam	1	67036/5RK	9,470
78 x 38	Wood	1	67037/2RK	10,155
78 x 38	P-Lam	1	67037/5RK	9,755
84 x 38	Wood	1	67038/2RK	10,465
84 x 38	P-Lam	1	67038/5RK	10,050
84 x 42	Wood	1	67039/2RK	10,590
84 x 42	P-Lam	1	67039/5RK	10,170
96 x 42	Wood	1	67040/2RK	11,025
96 x 42	P-Lam	1	67040/5RK	10,585
96 x 48	Wood	1	67041/2RK	12,595
96 x 48	P-Lam	1	67041/5RK	12,100
108 x 42	Wood	2	67042/2RK	12,405
108 x 42	P-Lam	2	67042/5RK	11,915
108 x 48	Wood	2	67043/2RK	14,170
108 x 48	P-Lam	2	67043/5RK	13,610
120 x 42	Wood	2	67044/2RK	13,780
120 x 42	P-Lam	2	67044/5RK	13,230
120 x 48	Wood	2	67045/2RK	15,745
120 x 48	P-Lam	2	67045/5RK	15,115
120 x 54	Wood	2	67046/2RK	17,715
120 x 54	P-Lam	2	67046/5RK	17,005
132 x 48	Wood	2	67047/2RK	17,320
132 x 48	P-Lam	2	67047/5RK	16,630
132 x 54	Wood	2	67048/2RK	19,490
132 x 54	P-Lam	2	67048/5RK	18,710
144 x 48	Wood	2	67049/2RK	18,895
144 x 48	P-Lam	2	67049/5RK	18,145
144 x 54	Wood	2	67050/2RK	21,255
144 x 54	P-Lam	2	67050/5RK	20,410
144 x 60	Wood	2	67051/2RK	23,610
144 x 60	P-Lam	2	67051/5RK	22,670

HIGH CAPACITY WIRE PAN

The Cable Management Pan is designed to conceal large volumes of cabling, retractor mechanisms, and components for M and Double Sided Forums. Ideal for narrow-depth tables, this hinged metal pan provides a clean and efficient under-table solution to keep unsightly equipment hidden.

**Image shown for general reference- your specific pan may look different.

Material: Powder-coated metal

Finish: Standard silver (custom color-matching available for an upcharge)

Application: Suitable for all Linear Una Conference tables

*Wire pan can be retrofitted to any Una Conference table

MDL# 55060

List Price: \$1,185



For more details contact customer service at 800.668.9318.

Una CONFERENCE COLLECTION

SUPER ELLIPSE SHAPE Design - modeus ID



Specify edge type; add the two letter code after the model number.



Reverse Bevel Edge (RB)



Facet Edge (FC)



Taper Edge (TE)



Flowform Edge (FF)
5% upcharge
laminates not available



Camber Edge (CE)
5% upcharge
laminates not available

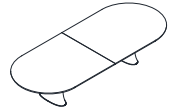

Una CONFERENCE 3 Fixed Bases 29" Table Height



Una CONFERENCE 4 Fixed Bases 29" Table Height



L" x D"	Top Finish	Top Sections	Model Number	List Price
156 48	Wood	2	67017/2RK	19,870
156 48	P-Lam	2	67017/5RK	19,075
156 54	Wood	2	67018/2RK	22,350
156 54	P-Lam	2	67018/5RK	21,460
156 60	Wood	2	67019/2RK	24,835
156 60	P-Lam	2	67019/5RK	23,845
168 48	Wood	2	67020/2RK	21,395
168 48	P-Lam	2	67020/5RK	20,540
168 54	Wood	2	67021/2RK	24,075
168 54	P-Lam	2	67021/5RK	23,115
168 60	Wood	2	67022/2RK	26,740
168 60	P-Lam	2	67022/5RK	25,675
180 48	Wood	3	67023/2RK	22,925
180 48	P-Lam	3	67023/5RK	22,010
180 54	Wood	3	67024/2RK	25,790
180 54	P-Lam	3	67024/5RK	24,760
180 60	Wood	3	67025/2RK	28,650
180 60	P-Lam	3	67025/5RK	27,220
192 54	Wood	3	67026/2RK	27,505
192 54	P-Lam	3	67026/5RK	26,410
192 60	Wood	3	67027/2RK	30,565
192 60	P-Lam	3	67027/5RK	29,345
204 54	Wood	3	67028/2RK	36,680
204 54	P-Lam	3	67028/5RK	35,215
204 60	Wood	3	67029/2RK	29,230
204 60	P-Lam	3	67029/5RK	28,065
216 54	Wood	3	67030/2RK	30,945
216 54	P-Lam	3	67030/5RK	29,710
216 60	Wood	3	67031/2RK	34,385
216 60	P-Lam	3	67031/5RK	33,015

L" x D"	Top Finish	Top Sections	Model Number	List Price
228 54	Wood	3	67032/2RK	32,665
228 54	P-Lam	3	67032/5RK	31,360
228 60	Wood	3	67033/2RK	36,290
228 60	P-Lam	3	67033/5RK	34,840
240 54	Wood	3	67034/2RK	34,385
240 54	P-Lam	3	67034/5RK	33,015
240 60	Wood	3	67035/2RK	38,200
240 60	P-Lam	3	67035/5RK	36,675

Model # 67048/2AE

132" x 54" Arc End Rectangle



Una CONFERENCE COLLECTION

SUPER ELLIPSE SHAPE Design - modeus ID



Specify edge type; add the two letter code after the model number.



Reverse Bevel Edge (RB)



Facet Edge (FC)



Taper Edge (TE)



Flowform Edge (FF)
5% upcharge
laminates not available



Camber Edge (CE)
5% upcharge
laminates not available

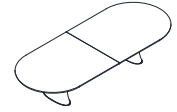

Una CONFERENCE 3 Fixed Bases 38" Table Height



Una CONFERENCE 4 Fixed Bases 38" Table Height



L" x D"	Top Finish	Top Sections	Model Number	List Price
156 48	Wood	2	67052/2RK	20,465
156 48	P-Lam	2	67052/5RK	19,650
156 54	Wood	2	67053/2RK	23,025
156 54	P-Lam	2	67053/5RK	22,105
156 60	Wood	2	67054/2RK	25,580
156 60	P-Lam	2	67054/5RK	24,560
168 48	Wood	2	67055/2RK	22,040
168 48	P-Lam	2	67055/5RK	21,160
168 54	Wood	2	67056/2RK	24,800
168 54	P-Lam	2	67056/5RK	23,810
168 60	Wood	2	67057/2RK	27,545
168 60	P-Lam	2	67057/5RK	26,445
180 48	Wood	3	67058/2RK	23,610
180 48	P-Lam	3	67058/5RK	22,670
180 54	Wood	3	67059/2RK	26,565
180 54	P-Lam	3	67059/5RK	25,505
180 60	Wood	3	67060/2RK	29,515
180 60	P-Lam	3	67060/5RK	28,035
192 54	Wood	3	67061/2RK	28,335
192 54	P-Lam	3	67061/5RK	27,205
192 60	Wood	3	67062/2RK	31,480
192 60	P-Lam	3	67062/5RK	30,225
204 54	Wood	3	67063/2RK	37,780
204 54	P-Lam	3	67063/5RK	36,275
204 60	Wood	3	67064/2RK	30,110
204 60	P-Lam	3	67064/5RK	28,910
216 54	Wood	3	67065/2RK	31,875
216 54	P-Lam	3	67065/5RK	30,605
216 60	Wood	3	67066/2RK	35,420
216 60	P-Lam	3	67066/5RK	34,005

L" x D"	Top Finish	Top Sections	Model Number	List Price
228 54	Wood	3	67067/2RK	33,645
228 54	P-Lam	3	67067/5RK	32,305
228 60	Wood	3	67068/2RK	37,380
228 60	P-Lam	3	67068/5RK	35,890
240 54	Wood	3	67069/2RK	35,420
240 54	P-Lam	3	67069/5RK	34,005
240 60	Wood	3	67070/2RK	39,350
240 60	P-Lam	3	67070/5RK	37,775

Una CONFERENCE COLLECTION

SUPER ELLIPSE SHAPE Design - modeus ID



Specify edge type; add the two letter code after the model number.



Reverse Bevel Edge (RB)



Facet Edge (FC)
not compatible with soft radius corner tops



Taper Edge (TE)



Flowform Edge (FF)
long edges only
5% upcharge
laminates not available
not compatible with soft radius corner tops



Camber Edge (CE)
8" radius required for soft corner tops
5% upcharge
laminates not available

All Closed Vista shape table sizes available with a 6" radius "Soft" corner (must be specified at time of order)

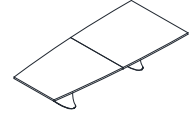

Una CONFERENCE
2 Height Adjustable Bases
Table Height 28½" - 38"



L" x D"	Top Finish	Top Sections	Model Number	List Price
84 38-54	Wood	1	67138/2CVA	14,150
84 38-54	P-Lam	1	67138/5CVA	13,660
96 38-54	Wood	1	67139/2CVA	15,455
96 38-54	P-Lam	1	67139/5CVA	14,905
108 38-54	Wood	2	67140/2CVA	16,555
108 38-54	P-Lam	2	67140/5CVA	15,970
120 38-54	Wood	2	67141/2CVA	17,245
120 38-54	P-Lam	2	67141/5CVA	16,630
132 38-54	Wood	2	67142/2CVA	21,655
132 38-54	P-Lam	2	67142/5CVA	20,860
144 38-54	Wood	2	67143/2CVA	22,975
144 38-54	P-Lam	2	67143/5CVA	22,130

HIGH CAPACITY WIRE PAN



*Wire pan can be retrofitted to any Una Conference table

MDL# 55060

List Price: \$1,185

The Cable Management Pan is designed to conceal large volumes of cabling, retractor mechanisms, and components for M and Double Sided Forums. Ideal for narrow-depth tables, this hinged metal pan provides a clean and efficient under-table solution to keep unsightly equipment hidden.

**Image shown for general reference- your specific pan may look different

Material: Powder-coated metal

Finish: Standard silver (custom color-matching available for an upcharge)

Application: Suitable for all Linear Una Conference tables

For more details contact customer service at **800.668.9318**.

Model # 67083/2AEA



Model # 67083/5AEA

132" x 54" Arc End Rectangle



Una CONFERENCE COLLECTION

CLOSED VISTA SHAPE Design - modeus ID



Specify edge type; add the two letter code after the model number.



Reverse Bevel Edge (RB)



Facet Edge (FC)
not compatible with soft radius corner tops



Taper Edge (TE)



Flowform Edge (FF)
long edges only
5% upcharge
laminates not available
not compatible with soft radius corner tops



Camber Edge (CE)
8" radius required for soft corner tops
5% upcharge
laminates not available

All Closed Vista shape table sizes available with a 6" radius "Soft" corner (must be specified at time of order)

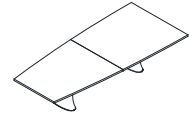

Una CONFERENCE
2 Fixed Bases
29" Table Height



Una CONFERENCE
2 Fixed Bases
38" Table Height



L" x D"	Top Finish	Top Sections	Model Number	List Price
84 x 38-54	Wood	1	67086/2CV	12,365
84 x 38-54	P-Lam	1	67086/5CV	11,875
96 x 38-54	Wood	1	67087/2CV	13,670
96 x 38-54	P-Lam	1	67087/5CV	13,120
108 x 38-54	Wood	2	67088/2CV	14,770
108 x 38-54	P-Lam	2	67088/5CV	14,185
108 x 43-60	Wood	2	67089/2CV	15,895
108 x 43-60	P-Lam	2	67089/5CV	15,260
120 x 38-54	Wood	2	67090/2CV	15,460
120 x 38-54	P-Lam	2	67090/5CV	14,845
120 x 43-60	Wood	2	67091/2CV	17,665
120 x 43-60	P-Lam	2	67091/5CV	16,960
132 x 38-54	Wood	2	67092/2CV	19,870
132 x 38-54	P-Lam	2	67092/5CV	19,075
132 x 43-60	Wood	2	67093/2CV	19,425
132 x 43-60	P-Lam	2	67093/5CV	18,650
144 x 38-54	Wood	2	67094/2CV	21,190
144 x 38-54	P-Lam	2	67094/5CV	20,345
144 x 43-60	Wood	2	67095/2CV	23,845
144 x 43-60	P-Lam	2	67095/5CV	22,890

L" x D"	Top Finish	Top Sections	Model Number	List Price
84 x 38-54	Wood	1	67112/2CV	12,740
84 x 38-54	P-Lam	1	67112/5CV	12,230
96 x 38-54	Wood	1	67113/2CV	14,085
96 x 38-54	P-Lam	1	67113/5CV	13,515
108 x 38-54	Wood	1	67114/2CV	15,215
108 x 38-54	P-Lam	1	67114/5CV	14,615
108 x 43-60	Wood	1	67115/2CV	16,370
108 x 43-60	P-Lam	1	67115/5CV	15,720
120 x 38-54	Wood	1	67116/2CV	15,925
120 x 38-54	P-Lam	1	67116/5CV	15,290
120 x 43-60	Wood	1	67117/2CV	18,195
120 x 43-60	P-Lam	1	67117/5CV	17,470
132 x 38-54	Wood	2	67118/2CV	20,465
132 x 38-54	P-Lam	2	67118/5CV	19,650
132 x 43-60	Wood	2	67119/2CV	20,010
132 x 43-60	P-Lam	2	67119/5CV	19,210
144 x 38-54	Wood	2	67120/2CV	21,830
144 x 38-54	P-Lam	2	67120/5CV	20,960
144 x 43-60	Wood	2	67121/2CV	24,560
144 x 43-60	P-Lam	2	67121/5CV	23,580

HIGH CAPACITY WIRE PAN

The Cable Management Pan is designed to conceal large volumes of cabling, retractor mechanisms, and components for M and Double Sided Forums. Ideal for narrow-depth tables, this hinged metal pan provides a clean and efficient under-table solution to keep unsightly equipment hidden.

**Image shown for general reference- your specific pan may look different.

Material: Powder-coated metal

Finish: Standard silver (custom color-matching available for an upcharge)

Application: Suitable for all Linear Una Conference tables

*Wire pan can be retrofitted to any Una Conference table

MDL# 55060

List Price: \$1,185



For more details contact customer service at **800.668.9318**.

Una CONFERENCE COLLECTION

CLOSED VISTA SHAPE Design - modeus ID



Specify edge type; add the two letter code after the model number.



Reverse Bevel Edge (RB)



Facet Edge (FC)
not compatible with soft radius corner tops



Taper Edge (TE)



Flowform Edge (FF)
long edges only
5% upcharge
laminates not available
not compatible with soft radius corner tops



Camber Edge (CE)
8" radius required for soft corner tops
5% upcharge
laminates not available

All Closed Vista shape table sizes available with a 6" radius "Soft" corner (must be specified at time of order)

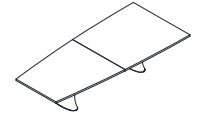

Una CONFERENCE
3 Fixed Bases
29" Table Height



Una CONFERENCE
4 Fixed Bases
29" Table Height



L" x D"	Top Finish	Top Sections	Model Number	List Price
156 38-54	Wood	2	67096/2CV	22,955
156 38-54	P-Lam	2	67096/5CV	22,040
156 43-60	Wood	2	67097/2CV	25,825
156 43-60	P-Lam	2	67097/5CV	24,800
168 38-54	Wood	2	67098/2CV	24,725
168 38-54	P-Lam	2	67098/5CV	23,740
168 43-60	Wood	3	67099/2CV	27,805
168 43-60	P-Lam	3	67099/5CV	26,700
180 38-54	Wood	2	67100/2CV	26,490
180 38-54	P-Lam	2	67100/5CV	25,435
180 43-60	Wood	2	67101/2CV	29,795
180 43-60	P-Lam	2	67101/5CV	28,605
192 38-54	Wood	2	67102/2CV	31,780
192 38-54	P-Lam	2	67102/5CV	30,510
192 43-60	Wood	3	67103/2CV	35,315
192 43-60	P-Lam	3	67103/5CV	33,900
204 38-54	Wood	3	67104/2CV	33,770
204 38-54	P-Lam	3	67104/5CV	32,420
204 43-60	Wood	3	67105/2CV	37,520
204 43-60	P-Lam	3	67105/5CV	36,025
216 38-54	Wood	3	67106/2CV	35,755
216 38-54	P-Lam	3	67106/5CV	34,325
216 43-60	Wood	3	67107/2CV	39,730
216 43-60	P-Lam	3	67107/5CV	38,145

L" x D"	Top Finish	Top Sections	Model Number	List Price
228 38-54	Wood	3	67108/2CV	37,745
228 38-54	P-Lam	3	67108/5CV	36,240
228 43-60	Wood	3	67109/2CV	41,940
228 43-60	P-Lam	3	67109/5CV	40,265
240 38-54	Wood	3	67110/2CV	39,730
240 38-54	P-Lam	3	67110/5CV	38,145
240 43-60	Wood	3	67111/2CV	44,140
240 43-60	P-Lam	3	67111/5CV	42,375

Model # 67048/2AE

132" x 54" Arc End Rectangle



Una CONFERENCE COLLECTION

CLOSED VISTA SHAPE Design - modeus ID



Specify edge type; add the two letter code after the model number.



Reverse Bevel Edge (RB)



Facet Edge (FC)
not compatible with soft radius corner tops



Taper Edge (TE)



Flowform Edge (FF)
long edges only
5% upcharge
laminates not available



Camber Edge (CE)
8" radius required for soft corner tops
5% upcharge
laminates not available

All Closed Vista shape table sizes available with a 6" radius "Soft" corner (must be specified at time of order)

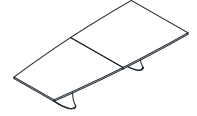

Una CONFERENCE
3 Fixed Bases
38" Table Height



Una CONFERENCE
4 Fixed Bases
38" Table Height



L" x D"	Top Finish	Top Sections	Model Number	List Price
156 38-54	Wood	2	67122/2CV	23,650
156 38-54	P-Lam	2	67122/5CV	22,705
156 43-60	Wood	2	67123/2CV	26,605
156 43-60	P-Lam	2	67123/5CV	25,545
168 38-54	Wood	2	67124/2CV	25,470
168 38-54	P-Lam	2	67124/5CV	24,450
168 43-60	Wood	2	67125/2CV	28,640
168 43-60	P-Lam	2	67125/5CV	27,500
180 38-54	Wood	2	67126/2CV	27,285
180 38-54	P-Lam	2	67126/5CV	26,200
180 43-60	Wood	2	67127/2CV	30,695
180 43-60	P-Lam	2	67127/5CV	29,465
192 38-54	Wood	3	67128/2CV	32,735
192 38-54	P-Lam	3	67128/5CV	31,430
192 43-60	Wood	3	67129/2CV	36,375
192 43-60	P-Lam	3	67129/5CV	34,920
204 38-54	Wood	3	67130/2CV	34,785
204 38-54	P-Lam	3	67130/5CV	33,400
204 43-60	Wood	3	67131/2CV	38,650
204 43-60	P-Lam	3	67131/5CV	37,105
216 38-54	Wood	3	67132/2CV	36,830
216 38-54	P-Lam	3	67132/5CV	35,360
216 43-60	Wood	3	67133/2CV	40,925
216 43-60	P-Lam	3	67133/5CV	39,290

L" x D"	Top Finish	Top Sections	Model Number	List Price
228 38-54	Wood	3	67134/2CV	38,880
228 38-54	P-Lam	3	67134/5CV	37,330
228 43-60	Wood	3	67135/2CV	43,200
228 43-60	P-Lam	3	67135/5CV	41,475
240 38-54	Wood	3	67136/2CV	40,925
240 38-54	P-Lam	3	67136/5CV	39,290
240 43-60	Wood	3	67137/2CV	45,465
240 43-60	P-Lam	3	67137/5CV	43,650

Model # 67083/2AEA



Model # 67083/5AEA



Una CONFERENCE COLLECTION

ROUND SHAPE Design - modeus ID



Specify edge type; add the two letter code after the model number.



Reverse Bevel Edge (RB)



Facet Edge (FC)



Taper Edge (TE)



Flowform Edge (FF)
5% upcharge
laminates not available



Camber Edge (CE)
5% upcharge
laminates not available



Una ROUND TABLE 1 Height Adjustable Bases Table Height 24" - 32"



Una ROUND TABLE 1 Height Adjustable Bases Table Height 28½" - 38"



Diameter	Top Finish	Top Sections	Model Number	List Price
42	Wood	1	67162/2RDA	7,450
42	P-Lam	1	67162/5RDA	7,195
48	Wood	1	67163/2RDA	8,285
48	P-Lam	1	67163/5RDA	8,000
54	Wood	1	67164/2RDA	9,460
54	P-Lam	1	67164/5RDA	9,120
60	Wood	1	67165/2RDA	10,755
60	P-Lam	1	67165/5RDA	10,365

Diameter	Top Finish	Top Sections	Model Number	List Price
42	Wood	1	67166/2RDA	7,610
42	P-Lam	1	67166/5RDA	7,350
48	Wood	1	67167/2RDA	8,445
48	P-Lam	1	67167/5RDA	8,155
54	Wood	1	67168/2RDA	9,615
54	P-Lam	1	67168/5RDA	9,280
60	Wood	1	67169/2RDA	10,910
60	P-Lam	1	67169/5RDA	10,525

Una ROUND TABLE 1 Fixed Base 29" Table Height



Una ROUND TABLE 1 Fixed Base 38" Table Height



Diameter	Top Finish	Top Sections	Model Number	List Price
42	Wood	1	67144/2RD	6,455
42	P-Lam	1	67144/5RD	6,195
48	Wood	1	67145/2RD	7,290
48	P-Lam	1	67145/5RD	7,000
54	Wood	1	67146/2RD	8,460
54	P-Lam	1	67146/5RD	8,125
60	Wood	1	67147/2RD	9,755
60	P-Lam	1	67147/5RD	9,370

Diameter	Top Finish	Top Sections	Model Number	List Price
42	Wood	1	67153/2RD	6,650
42	P-Lam	1	67153/5RD	6,385
48	Wood	1	67154/2RD	7,510
48	P-Lam	1	67154/5RD	7,210
54	Wood	1	67155/2RD	8,715
54	P-Lam	1	67155/5RD	8,370
60	Wood	1	67156/2RD	10,050
60	P-Lam	1	67156/5RD	9,650

TERMS AND CONDITIONS OF SALE

PRICES

All prices are list prices, freight included, blanket-wrapped, dock delivered, from the manufacturing source to any location in the contiguous United States.

Brokerage is paid by Nienkämper for product shipped to the United States.

Due to existing conditions in regard to cost of labor and materials, we reserve the right to change prices without notice.

TERMS

Net 30 days from date of invoice to accredited buyers. Two per cent (2%) interest charged monthly on overdue accounts. Deposit of 50% is required with order. Terms will be established upon credit evaluation. Due to delays in processing references, first orders may be treated as C.B.D. orders.

ORDER CONFIRMATION

Orders are accepted upon issuance of our order confirmation and are subject to the terms set forth therein; notwithstanding any variance from the terms of the buyer's order form.

Nienkämper is not liable for any delay or failure to deliver caused by labor or transportation difficulties, accidents, acts of God, failure of sources of supply, or other causes beyond our control, and changes will affect the delivery date.

CHANGE OF ORDERS OR CANCELLATIONS

Changes or cancellations are subject to our ability to conform. A charge will be levied against cancelled or changed orders based on costs already incurred by Nienkämper. All changes must be in writing and submitted on a revised purchase order. Changes will affect the delivery date.

STORAGE

If goods cannot be accepted when ready, we may transfer them to storage (which is to be deemed as delivery for invoice purposes). The customer accepts risks and will be charged at prevailing rates.

FREIGHT

Prices include freight charges, blanket-wrapped, dock delivered, from the manufacturing source to any location in the contiguous United States. Packing and/or crating are available, if required, upcharges apply.

CLAIMS

All furniture is given to the carrier and signed for in good condition. It is the responsibility of the receiver to sign for the goods in the presence of the carrier and note the condition in which they are received. Freight claims should be filed with the carrier.

WARRANTY

There are no express or implied warranties, conditions and obligations of the manufacturer, whether statutory or otherwise that extend beyond the description on the face hereof. Our furniture is made to the highest standard and is warranted free from defects of material and workmanship for five years from the date of delivery. During the warranty period we will repair or replace such merchandise as shall prove to be defective, during normal usage in accordance with manufacturer's specifications. The manufacturer shall not be liable for defect wholly attributable to normal manufacturing process. Replacement or repair of the Product shall be the sole remedy of the Customer, and the manufacturer shall not be liable for any direct, indirect, incidental, or consequential loss or damage suffered by the Customer by reason of any defect in workmanship or manufacture of the Product or inability to use the Product. Moreover, this warranty does not cover accidental damage, abuse, alteration, ordinary wear and tear of Goods, negligence and misuse nor variations over which we have no control such as heat or humidity or damage to which the Goods are connected that is not attributable to the failure of the goods themselves. This warranty is null and void when the product is installed with hardware other than that supplied and/or when installed differently than recommended in the installation guide. Modification to the product or hardware may result in failure of the product and cause damage and/or injury.

WOOD FINISHES

Nienkämper offers a wide variety of standard light finishes on cherry, mahogany and figured anagré wood veneers, and a clear natural finish on figured anagré, figured sycamore, maple, bird's eye maple and curly maple.

Light finishes do not mask the grain and other characteristics of each wood species. It is important to understand that pieces of the same type of wood will not look identical when a light finish is used. The appearance of the finish will also depend on the natural color of the veneer. Cherry darkens over time as the wood ages. Pin knots and gum pockets are inherent traits.

Wood is a naturally variable raw material; its variances are not within the furniture manufacturer's control and are therefore not considered defects under this warranty.