

nienkämpfer

VOX® DOUBLE SIDED FORUMS



2026

INTRODUCTION



Standard Features

The Vox® Double-Sided Forum features a multi-directional hinged lid, providing access from either side of the table. The Forum sits flush with the tabletop, and the lid matches the work surface finish. A thin aluminum bezel lines the cutout in both the tabletop and lid for added durability and a color detail.

The Vox® Double-Sided Forum is available in a 4-module configuration. Modules can be specified as Power/Charging, Data/AV, Split Plates, or Retractors. Modules can be swapped or repositioned on site if your power or AV requirements change.

Power modules include:

3 simplexes, or 2 simplexes with USB-A or USB-C charging

Power units are available with a pre-wired cord, hardwired feed, or daisy-chain feed.

Data/AV plates contain 4 fittings. Individual fittings can be swapped out, or the entire plate can be replaced on site as needed.

FINISHES

The Vox® Double-Sided Forum is constructed from sturdy aluminum and finished with a durable powder coat. The body is available in Black, Gray, or White powder coat. The lid is matched to the veneer, plastic laminate or engineered stone used on the tabletop for a seamless look.

Custom powder coat colors are available upon request; please note that this may affect pricing and lead times. Contact Nienkamper Customer Service at **800.668.9318**.

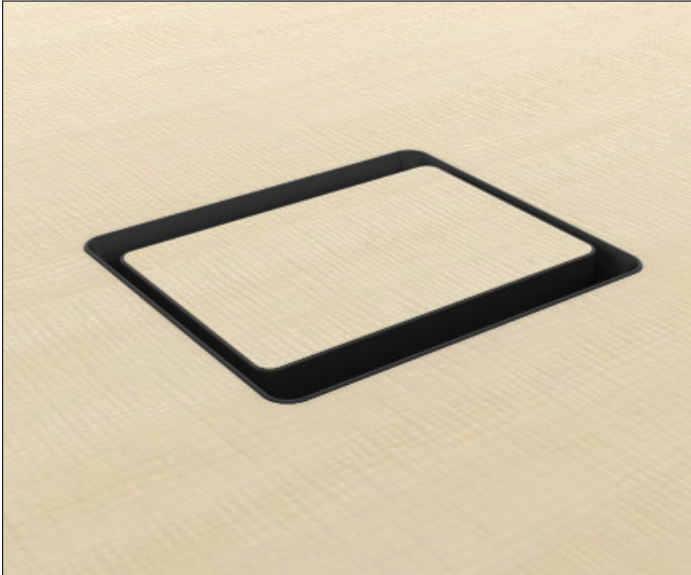

BLACK

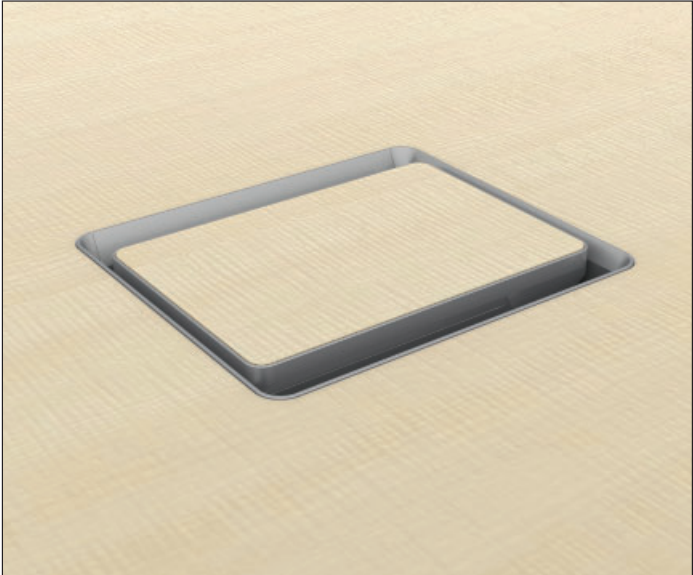

GRAY



WHITE

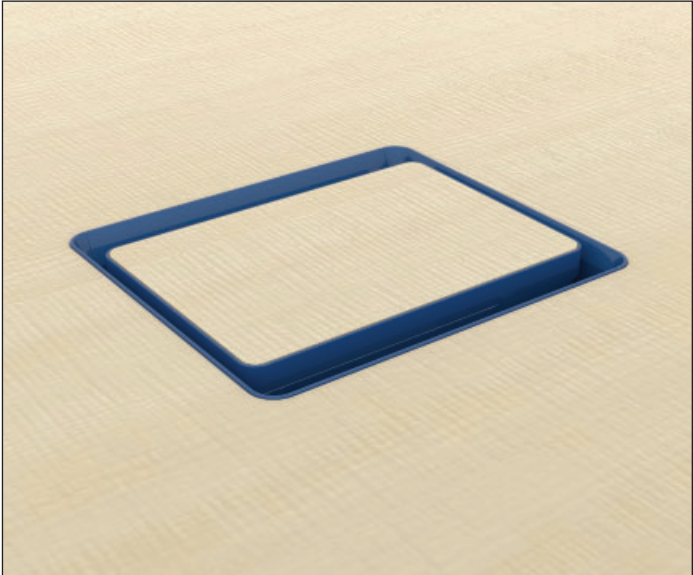

CUSTOM

VOX® DOUBLE SIDED FORUM - ORDER FORM

THE VOX® DOUBLE SIDED FORUM HAS 4 PORTS THAT CAN BE POPULATED WITH VARIOUS FACE PLATES.

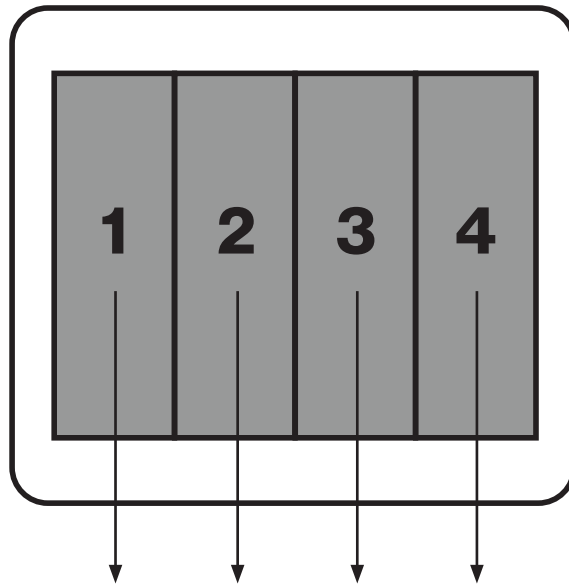

Base Model# - G-

_____ - _____ - _____ - _____
 PLATE 1 PLATE 2 PLATE 3 PLATE 4

- Select the modular faceplate required from pages 241-243.
- Fill in the 2 digit model number of each plate in the desired location.
- For custom modular plates, fill in "CX" as the model number.

\$970 + _____ + _____ + _____ + _____ = _____
 BASE MODEL COST PLATE #1 COST PLATE #2 COST PLATE #3 COST PLATE #4 COST

• Add up the cost

*Base model cost includes finished veneer or plastic laminate lid.

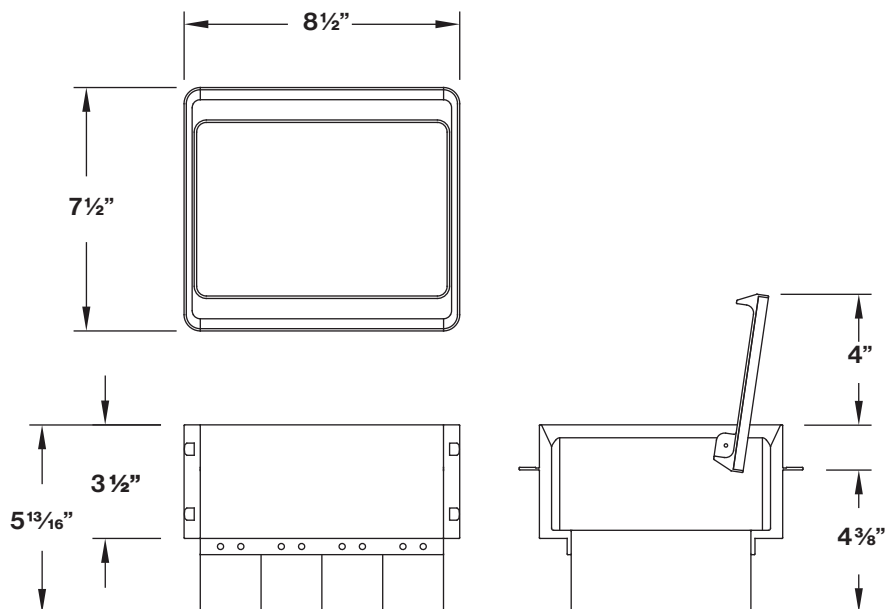

POWER FACEPLATES

DS-1P



Model Number	List Price
DS-1P	\$265
DS-1P-SW	\$300
DS-1P-4T	\$295

DESCRIPTION

- Single module faceplate contains 3 power receptacles 15A 120V
- Pre wired with a 10' cord.
- Site wired with a 72" metallic shielded cable.
- Site connection to power source required.
- Comes with a daisy chain wire system that runs on two circuits
- Site connection to power source required.

DS-2P



Model Number	List Price
DS-2P	\$365
DS-2P-SW	\$410
DS-2P-4T	\$400

DESCRIPTION

- Single module faceplate contains 2 power receptacles 15A 120V,
- 2 USB-A, with 2 Amps per port.
- Pre wired with a 10' cord.
- Site wired with a 72" metallic shielded cable.
- Site connection to power source required.
- Comes with a daisy chain wire system that runs on two circuits
- Site connection to power source required.

POWER FACEPLATES

DS-3P



MODEL NUMBER	LIST PRICE
DS-3P	\$365
DS-3P-SW	\$410
DS-3P-4T	\$400

DESCRIPTION

- Single module faceplate contains 2 power receptacles 15A 120V,
- USB-A+C, with 2 Amps per port 18W.
- Pre wired with a 10' cord.
- Site wired with a 72" metallic shielded cable.
- Site connection to power source required.
- Comes with a daisy chain wire system that runs on two circuits
- Site connection to power source required.

DS-4P



MODEL NUMBER	LIST PRICE
DS-4P	\$555
DS-4P-SW	\$605
DS-4P-4T	\$595

DESCRIPTION

- Single module faceplate contains 1 power receptacle 15A 120V,
- 1 USB-C, with 100W
- Pre wired with a 10' cord.
- Site wired with a 72" metallic shielded cable.
- Site connection to power source required.
- Comes with a daisy chain wire system that runs on two circuits
- Site connection to power source required.

SPLIT PLATE

DS-SP

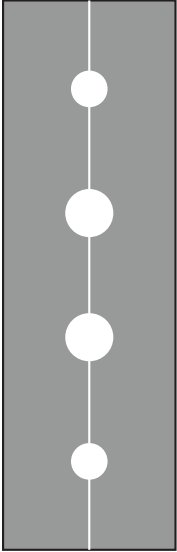

MODEL NUMBER	LIST PRICE
DS-SP	\$100
	PLATE ONLY

DESCRIPTION

- Split plate has 2 openings that are 3/8" diameter and 2 openings at 7/16" diameter.

BLANK PLATE

DS-BP

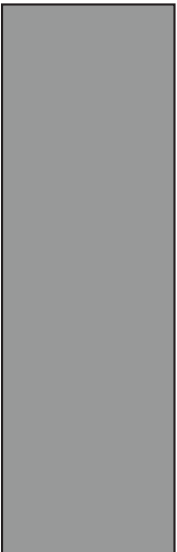

MODEL NUMBER	LIST PRICE
DS-BP	\$100
	PLATE ONLY

DESCRIPTION

- Blank plate used as filler within Forum.

CUSTOM AV/DATA FACE-PLATES

DS-CX

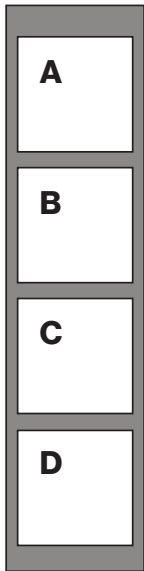

MODEL NUMBER

POSITION A

POSITION B

POSITION C

POSITION D

+\$100 PLATE COST

DESCRIPTION

The CX plate has 4 spaces for fittings and can be used in any position in the forum.



A5 \$190

SIEMON CAT 6 data fitting with 10' connector cable (Female to Male)



C \$95

Audio- 3.5mm Mini stereo Jack with 10' cord (Female to Male)



H \$145

USB port 3.0 with 10' cord (Female to Male)



G \$205

DB15HD, VGA connector, 10' cord (Female to Male)



HD \$205

HDMI coupler (female to female) with 18" cord



B \$70

Blank Plate

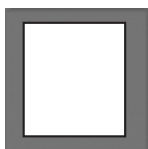

O \$70

Open port for clients own data fitting. Each port selected will be supplied with one set of data adapter kit.

RETRACTOR FACE-PLATES

DS-6R

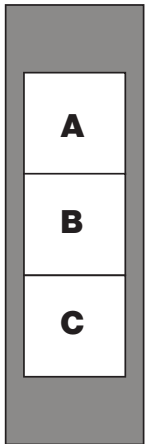

MODEL NUMBER	LIST PRICE
DS-6R	\$100
PLATE ONLY	

DESCRIPTION

- Extron Retractor faceplate fits 3 Extron retractors. The 6R retractor faceplate can only be placed in position 1 and 4 on the G forum.
- Retractors can be bought through Nienkämper or Users can supply there own Extron retractor components. *See page 246 for req'd Filler Module.
- Note: This plate holds 3 Extron Retractors. Any spot not using a retractor will require a filler module. If client is suppling there own retractors order filler model #70-1065-35.

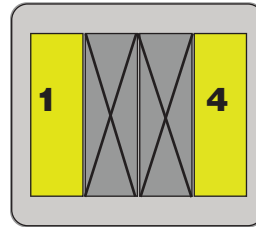

R-01 **\$1,560**

VGA - Retractor series II - with 36" long cord.



R-03 **\$1,560**

Data - CAT 6 - retractor series II - with 36" long cord



R-05 **\$1,560**

USB (signal) - retractor series II - with 36" long cord / USB-A to USB-A



R-13 **\$1,730**

Display Port - retractor series II - with 36" long cord



R-15 **\$1,905**

Display Port - retractor series II - with 60" long cord



R-02 **\$1,560**

3.5mm audio - retractor series II - with 36" long cord



R-08 **\$1,730**

3.5mm audio - retractor series II - with 60" long cord



R-04 **\$1,560**

HDMI - retractor series II - with 36" long cord



R-10 **\$1,730**

HDMI - retractor series II - with 60" long cord

R-06 **\$1,730**

VGA & Audio - retractor series II - with 36" long cord / VGA M-M & 3.5mm audio

R-12 **\$1,905**

VGA & audio - retractor series II - with 60" long cord / VGA M-M & 3.5mm audio

R-14 **\$1,995**

USB-C Pro 8K - retractor series II - with 36" long cord / USB-C to USB-C

R-16 **\$2,170**

USB-C Pro 8K - retractor series II - with 60" long cord / USB-C to USB-C

SPLIT PLATE

DS-FM



MODEL NUMBER	LIST PRICE
DS-FM	\$190

DESCRIPTION

- A Filler Module is required if less than 3 Extron retractors are ordered on each Plate 1 & Plate 4.
- A Filler Module is required for clients supplying their own retractors.