

nienkämpfer

VOX®
FORUMS



2026

"M & N" Series Vox Forums Pages 209-228

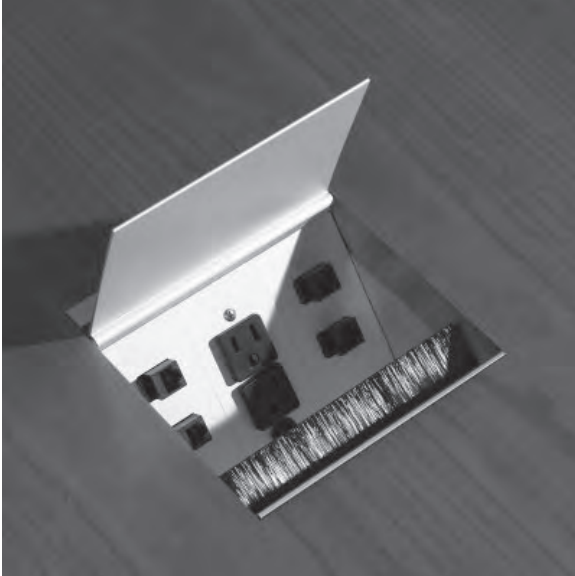

M-Series Forums – 6" wide and N-Series Forums – 12" wide, offer increased capacity and scale. Its modular design makes it simple to configure to your needs

Individual plates can be replaced / retrofitted as required in the field.

POSITIONING VOX® FORUMS ON CONFERENCE TABLES













DETERMINING FORUM PLACEMENT ON TABLES

The following table serves as a guideline for defining and distributing Forums along the tabletop. The rectangular icons on the left are for reference only, as all other shapes in the collection fit within this outline.

For tables with Access, Tower, and Drum bases, Forums can be positioned over the base and share the same placement options shown for the Duo base in the chart below.

For LCS Tables or custom Forum positioning, please contact Customer Service at **800.668.9318**.









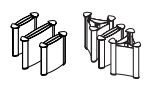

	Tables 72 x 36 - 84 x 42 	Tables 96 x 42 - 108 x 48 	Tables 120 x 42 - 132 x 54 	Tables 144 x 48 - 168 x 66 										
	M-Series Forum	N-Series Forum	M-Series Forum	N-Series Forum	M-Series Forum	N-Series Forum	M-Series Forum	N-Series Forum						
 <p>FP1 - At center</p>	•	•	•	•	•	•	•	N/A on Duo Base 42" - 48" D						
 <p>FP2C - Centered</p>	•	•	•	•	•	•	•	•	•	N/A on Duo Base 42" - 48" D	•	•	N/A on Duo Base 48" D	
 <p>FP2 - Equally Spaced</p>	•	•	•	•	•	•	•	•	•	•	•	•	N/A on Duo Base 48" D	
 <p>FP2E - At ends of table</p>			•	•	•	•	•	•	•	•	•	•	N/A on Duo Base 48" D	
 <p>FP3 - Equally Spaced</p>			•	•	•	•	•	•	•	•	•	•	N/A on Duo Base 48" D	
 <p>FP4 - Equally Spaced</p>														
 <p>FP4A - Symmetrically Spaced</p>							•	•	•	•	•	•	•	N/A on Duo Base 48" D

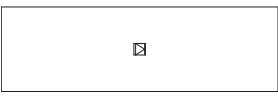
DETERMINING FORUM PLACEMENT ON TABLES

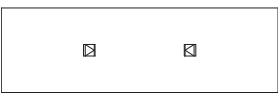
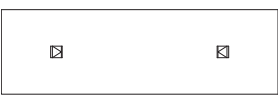
The following table serves as a guideline for defining and distributing Forums along the tabletop. The rectangular icons on the left are for reference only, as all other shapes in the collection fit within this outline.

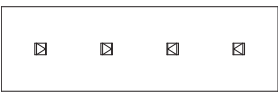
For tables with Access, Tower, and Drum bases, Forums can be positioned over the base and share the same placement options shown for the Duo base in the chart below.

For LCS Tables or custom Forum positioning, please contact Customer Service at **800.668.9318**.

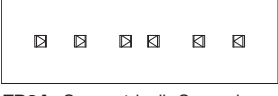
	Tables 180 x 48 - 192 x 72 	Tables 204 x 54 - 216 x 78 	Tables 204 x 54 - 216 x 78 	Tables 228 x 54 - 240 x 84 				
	M-Series Forum	N-Series Forum	M-Series Forum	N-Series Forum	M-Series Forum	N-Series Forum	M-Series Forum	N-Series Forum
 <p>FP1 - At center</p>	• N/A 180", 192" with Duo Base	• N/A on Duo Base 48" D			•	•	•	•
 <p>FP2C - Centered</p>	•	• N/A on Duo Base 48" D	•	•	•	•	•	•
 <p>FP2 - Equally Spaced</p>	•	• N/A on Duo Base 48" D	•	•	•	•	•	•
 <p>FP2E - At ends of table</p>	•	• N/A on Duo Base 48" D	•	•	•	•	•	•
 <p>FP3 - Equally Spaced</p>	• N/A 180", 192" with Duo Base	• N/A on Duo Base 48" D			•	•	•	•
 <p>FP4 - Equally Spaced</p>								
 <p>FP4A - Symmetrically Spaced</p>	•	•	•	•	•	•	•	•
 <p>FP5 - Equally Spaced</p>	• N/A 180", 192" with Duo Base	•			•	•	•	•
 <p>FP6 - Equally Spaced</p>								
 <p>FP6A - Symmetrically Spaced</p>	•	• N/A on Duo Base 48" D	•	•	•	•	•	•

DETERMINING FORUM PLACEMENT ON TABLES

The following table serves as a guideline for defining and distributing Forums along the tabletop. The rectangular icons on the left are for reference only, as all other shapes in the collection fit within this outline.

For tables with Access, Tower, and Drum bases, Forums can be positioned over the base and share the same placement options shown for the Duo base in the chart below.

For LCS Tables or custom Forum positioning, please contact Customer Service at **800.668.9318**.

	Tables 42" w/ø - 60" w/ø		Tables 42" w/ø - 60" w/ø		Tables 66" w/ø - 72" w/ø		Tables 66" w/ø - 72" w/ø		Tables 78" w/ø - 96" w/ø		Tables 78" w/ø - 96" w/ø	
	Forum Series M N		Forum Series M N		Forum Series M N		Forum Series M N		Forum Series M N		Forum Series M N	
Wave Square Round FP1 - At center	•	•	•	•	•	•	•	•	•	•	•	•
			N/A 42"	N/A 42", 48"								
Wave Square Round FP2C - Centered					•	•	•	•	•	•	•	•
						N/A 66"						
Wave Square Round FP3 - Equally Spaced					•	•	•	•	•	•	•	•
										N/A 78"		N/A 78"
Wave Square Round FP4 - Equally Spaced					•	•	•	•	•	•	•	•
					N/A 66"	N/A 66"	N/A 66"	N/A 66"		N/A 78"		

DATA/VOICE WIRING OPTIONS



Nienkämper is a **recognized installer** for data systems described in **Vox® Forum products**.

Vox® Forums can be manufactured with several factory wired data systems including "Hubbell", "Leviton", "Siemon", "Belden" and "Legrand/ Ortronics". All of these systems guarantee the highest level of data transmissions.

Vox® Forum products have been tested by the independent laboratories of these companies and are compliant with all aspects of proper installation and performance.

Nienkämper recommends the use of these **pre-wired systems** as they offer the **best value, quality** and **safety**.

Options for data/voice connections



- CAT 6A
(available in custom plate only)

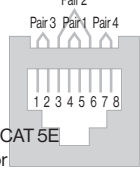
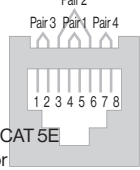

- CAT 5E
or
• CAT 6 T568A

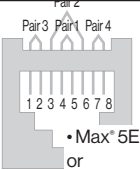
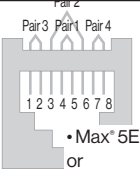

- Max® 5E
or
• Max® 6 T568A



- CAT 5E
or
• CAT 6



- CAT 5E
or
• CAT 6

Nienkämper recommends the use of Vox® **pre-wired systems** as they offer the **best value, quality and safety** to the consumer.

Standard Vox Forums are listed by Underwriters Laboratories Inc. under several categories. These listings qualify a level of safety guaranteed by UL's published standards for safety which UL uses as a benchmark for testing and listing products.

The right to bear the UL mark is contingent on the fact that absolutely no alteration is made to the product as it was submitted and tested by Underwriters Laboratories. This is to ensure that assemblies are not manufactured with inferior or replacement parts; this would void or alter the result of the original examination and tests conducted by UL.

The UL mark is included on a label that is attached to the underside of listed Vox® products. This label includes:

- The date the component was assembled and tested.
- A serial number for tracking purposes.
- The listing category located under the UL mark.
- UL file number that can be used as a reference at UL for any inquiries about the product.

SAMPLE UL/CSA LABEL

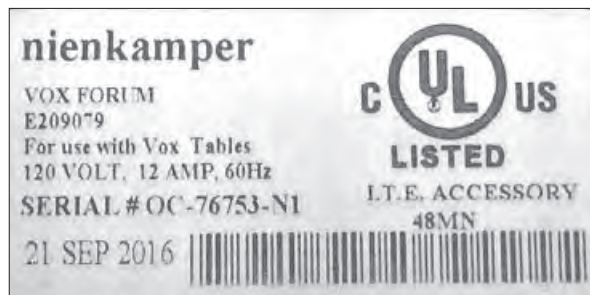

All listed assemblies have POWER/ELECTRICAL components wired by Nienkämper and undergo the following tests:

Production Line Grounding Test - Continuity: This test checks for grounding continuity between the grounding conductor of the attachment plug and the designated main grounding point including any accessible dead-metal parts of the assembly. There must be grounding continuity between all parts.

Production-line Dielectric Voltage Withstand Test - Hi-pot: Each product shall withstand without electrical breakdown, as a routine production-line test, the application of an AC potential at a frequency within the range of 40-70 Hz or a DC potential between the primary wiring, including connected components, and accessible dead metal parts that are likely to become energized. This test is conducted when the product is fully assembled, and cannot be unwired, modified or disassembled afterwards.

Production-line - Polarity Test: This test verifies proper electrical polarity of both the grounded (neutral) and the ungrounded (hot) supply circuit conductors of the Forum and all parts intended to be connected to the grounded (neutral) and ungrounded (hot) supply circuit conductors of the attachment plug. Conductivity indications must confirm the correct connection of all parts specified.

VOX® FORUM CONFIGURATOR

Specifying the “M” and “N” series Vox Forum couldn’t be simpler.

“M” and “N” series Forums can be individually configured online with the “**Vox Forum Configurator**”.

Log onto the Nienkämper website www.nienkamper.com and follow the links or simply type www.vfc3.nienkamper.com in your browser and go straight to this online tool.



Configuring your Forum is easy: simply drag and drop the options you want to build the product you need.

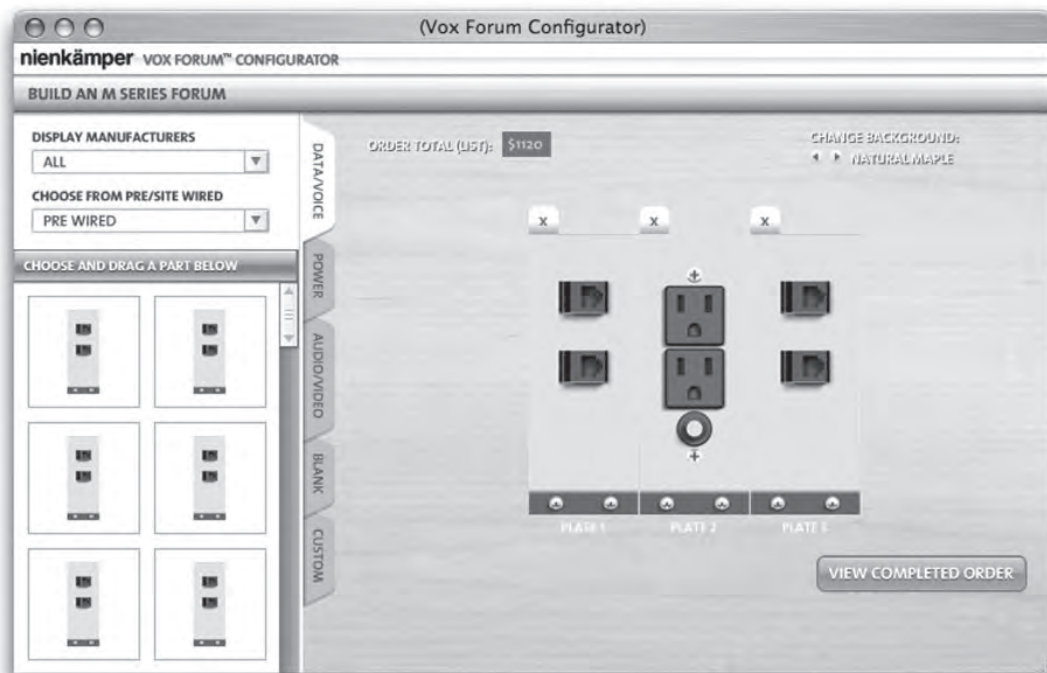

Download this form at www.nienkamper.com/vfc/forum

Modular Plate #1 Modular Plate #2 Modular Plate #3



Base Model # - M - _____ - _____ - _____ -

Modular Plate #1 Modular Plate #2 Modular Plate #3

- Select the modular faceplate required from pages 230-234.
- Fill in the 2 digit model number of each plate in the desired location.
- For custom modular plates, fill in "CX" as the model number.
- To create a custom modular plate, turn to pages 236.

\$ 630 + _____ + _____ + _____ = _____

Base Model Cost Plate #1 Cost Plate #2 Cost Plate #3 Cost Total Forum Cost

- Add up the cost.

Use this section when ordering Custom Modular Faceplates

Place your selection of part numbers from page 186.

		Position A	Position B	Position C
Custom Modular Plate #1 -	CX1	- _____	- _____	- _____
Custom Modular Plate #2 -	CX2	- _____	- _____	- _____
Custom Modular Plate #3 -	CX3	- _____	- _____	- _____

Quote # or Order # : _____ Date: _____

Approval Signature: _____

Download this form at www.nienkamper.com/vfc/forum

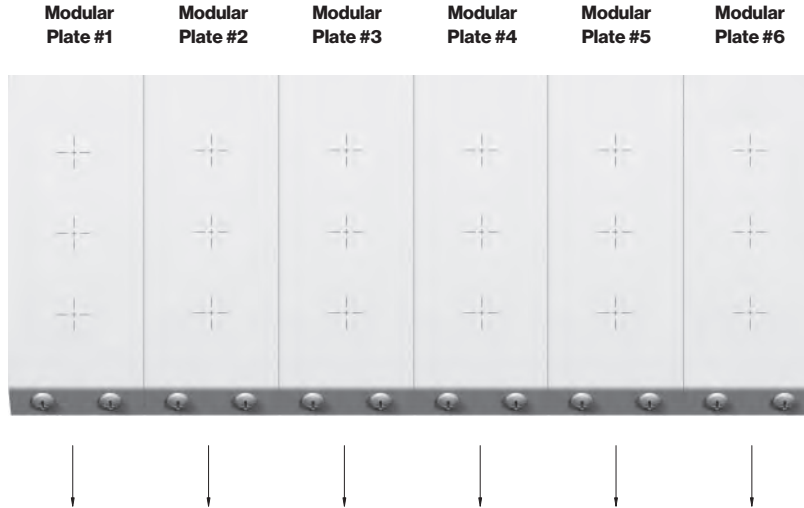

- Select the modular faceplate required from pages 230-235.
- Fill in the 2 digit model number of each plate in the desired location.
- For custom modular plates, fill in "CX" as the model number.
- To create a custom modular plate, turn to pages 236.

Base Model # - N - _____ - _____ - _____ - _____ - _____ - _____

Modular Plate #1	Modular Plate #2	Modular Plate #3	Modular Plate #4	Modular Plate #5	Modular Plate #6
-------------------------	-------------------------	-------------------------	-------------------------	-------------------------	-------------------------

\$ 695	+	_____	+	_____	+	_____	+	_____	+	_____	+	_____	=	_____
Base Model Cost		Plate #1 Cost		Plate #2 Cost		Plate #3 Cost		Plate #4 Cost		Plate #5 Cost		Plate #6 Cost		Total Forum Cost

• Add up the cost.

Use this section when ordering Custom Modular Faceplates

Place your selection of part number from page 186 in the desired location below.

	Position A	Position B	Position C
Custom Modular Plate	CX1 - _____	- _____	- _____
Custom Modular Plate	CX2 - _____	- _____	- _____
Custom Modular Plate	CX3 - _____	- _____	- _____
Custom Modular Plate	CX4 - _____	- _____	- _____
Custom Modular Plate	CX5 - _____	- _____	- _____
Custom Modular Plate	CX6 - _____	- _____	- _____

Quote # or Order # : _____ Date: _____

Approval Signature: _____

"M & N" SERIES VOX® FORUM – MODULAR FACEPLATES



SINGLE MODULE FACEPLATE CONTAINS THE FOLLOWING: 2-DATA



Model Number	List Price	Pre Wired – All Cords Terminated With Male Plugs
0E	395	2 - Hubbell Cat5e Data, 10' Cord
1E	795	2 - Hubbell Cat6 Data, 10' Cord
2E	585	2 - Leviton Cat5e Data, 10' Cord
3E	795	2 - Leviton Cat6 Data, 10' Cord
4E	585	2 - Siemon Cat5e Data, 16' Cord
5E	795	2 - Siemon Cat6 Data, 16' Cord
6E	585	2 - Belden Cat5e Data, 10' Cord
7E	795	2 - Belden Cat6 Data, 10' Cord
8E	695	2 - Ortronics Cat5e Data, 10' Cord
9E	785	2 - Ortronics Cat6 Data, 10' Cord

Model Number	List Price	Site Wired – Only Jacks Supplied
0B	350	2 - Hubbell Cat5e Data, Site Wiring Required
1B	490	2 - Hubbell Cat6 Data, Site Wiring Required
2B	350	2 - Leviton Cat5e Data, Site Wiring Required
3B	490	2 - Leviton Cat6 Data, Site Wiring Required
4B	350	2 - Siemon Cat5e Data, Site Wiring Required
5B	490	2 - Siemon Cat6 Data, Site Wiring Required
6B	350	2 - Belden Cat5e Data, Site Wiring Required
7B	490	2 - Belden Cat6 Data, Site Wiring Required
8B	350	2 - Ortronics Cat5e Data, Site Wiring Required
9B	435	2 - Ortronics Cat6 Data, Site Wiring Required

SINGLE MODULE FACEPLATE CONTAINS THE FOLLOWING: 1-DATA, 1-VOICE



Model Number	List Price	Pre Wired – All Cords Terminated With Male Plugs
0K	365	1 - Hubbell Cat5e Data & 1-Rj45 Voice - 10' Cords
1K	585	1 - Hubbell Cat6 Data & 1-Rj45 Voice - 10' Cords
2K	605	1 - Leviton Cat5e Data & 1-Rj45 Voice - 10' Cords
3K	700	1 - Leviton Cat6 Data & 1-Rj45 Voice - 10' Cords
4K	605	1 - Siemon Cat5e Data & 1-Rj45 Voice - 16' Cords
5K	700	1 - Siemon Cat6 Data & 1-Rj45 Voice - 16' Cords
6K	605	1 - Belden Cat5e Data & 1-Rj45 Voice - 10' Cords
7K	700	1 - Belden Cat6 Data & 1-Rj45 Voice - 10' Cords
8K	595	1 - Ortronics Cat5e Data & 1-Rj45 Voice - 10' Cords
9K	640	1 - Ortronics Cat6 Data & 1-Rj45 Voice - 10' Cords

Model Number	List Price	Site Wired – Only Jacks Supplied
0J	325	1 - Hubbell Cat5e Data & 1-Rj45 Voice - Site Wired
1J	375	1 - Hubbell Cat6 Data & 1-Rj45 Voice - Site Wired
2J	350	1 - Leviton Cat5e Data & 1-Rj45 Voice - Site Wired
3J	410	1 - Leviton Cat6 Data & 1-Rj45 Voice - Site Wired
4J	350	1 - Siemon Cat5e Data & 1-Rj45 Voice - Site Wired
5J	410	1 - Siemon Cat6 Data & 1-Rj45 Voice - Site Wired
6J	350	1 - Belden Cat5e Data & 1-Rj45 Voice - Site Wired
7J	410	1 - Belden Cat6 Data & 1-Rj45 Voice - Site Wired
8J	350	1 - Ortronics Cat5e Data & 1-Rj45 Voice - Site Wired
9J	400	1 - Ortronics Cat6 Data & 1-Rj45 Voice - Site Wired

SINGLE MODULE FACEPLATE CONTAINS THE FOLLOWING: 3-DATA



Model Number	List Price	Pre Wired – All Cords Terminated With Male Plugs
0F	545	3 - Hubbell Cat5e Data, 10' Cord
1F	1,150	3 - Hubbell Cat6 Data, 10' Cord
2F	815	3 - Leviton Cat5e Data, 10' Cord
3F	1,150	3 - Leviton Cat6 Data, 10' Cord
4F	815	3 - Siemon Cat5e Data, 16' Cord
5F	1,150	3 - Siemon Cat6 Data, 16' Cord
6F	815	3 - Belden Cat5e Data, 10' Cord
7F	1,150	3 - Belden Cat6 Data, 10' Cord
8F	1,015	3 - Ortronics Cat5e Data, 10' Cord
9F	1,135	3 - Ortronics Cat6 Data, 10' Cord

Model Number	List Price	Site Wired – Only Jacks Supplied
0C	470	3 - Hubbell Cat5e Data, Site Wiring Required
1C	685	3 - Hubbell Cat6 Data, Site Wiring Required
2C	470	3 - Leviton Cat5e Data, Site Wiring Required
3C	685	3 - Leviton Cat6 Data, Site Wiring Required
4C	470	3 - Siemon Cat5e Data, Site Wiring Required
5C	685	3 - Siemon Cat6 Data, Site Wiring Required
6C	470	3 - Belden Cat5e Data, Site Wiring Required
7C	685	3 - Belden Cat6 Data, Site Wiring Required
8C	470	3 - Ortronics Cat5e Data, Site Wiring Required
9C	625	3 - Ortronics Cat6 Data, Site Wiring Required

SINGLE MODULE FACEPLATE CONTAINS THE FOLLOWING: 2-DATA, 1-VOICE



Model Number	List Price	Pre Wired – All Cords Terminated With Male Plugs
0M	490	2 - Hubbell Cat5e Data & 1-Rj45 Voice - 10' Cords
1M	905	2 - Hubbell Cat6 Data & 1-Rj45 Voice - 10' Cords
2M	815	2 - Leviton Cat5e Data & 1-Rj45 Voice - 10' Cords
3M	1,025	2 - Leviton Cat6 Data & 1-Rj45 Voice - 10' Cords
4M	815	2 - Siemon Cat5e Data & 1-Rj45 Voice - 16' Cords
5M	1,025	2 - Siemon Cat6 Data & 1-Rj45 Voice - 16' Cords
6M	815	2 - Belden Cat5e Data & 1-Rj45 Voice - 10' Cords
7M	1,025	2 - Belden Cat6 Data & 1-Rj45 Voice - 10' Cords
8M	1,015	2 - Ortronics Cat5e Data & 1-Rj45 Voice - 10' Cords
9M	1,095	2 - Ortronics Cat6 Data & 1-Rj45 Voice - 10' Cords

Model Number	List Price	Site Wired – Only Jacks Supplied
0L	420	2 - Hubbell Cat5e Data & 1-Rj45 Voice - Site Wired
1L	585	2 - Hubbell Cat6 Data & 1-Rj45 Voice - Site Wired
2L	470	2 - Leviton Cat5e Data & 1-Rj45 Voice - Site Wired
3L	625	2 - Leviton Cat6 Data & 1-Rj45 Voice - Site Wired
4L	470	2 - Siemon Cat5e Data & 1-Rj45 Voice - Site Wired
5L	625	2 - Siemon Cat6 Data & 1-Rj45 Voice - Site Wired
6L	470	2 - Belden Cat5e Data & 1-Rj45 Voice - Site Wired
7L	625	2 - Belden Cat6 Data & 1-Rj45 Voice - Site Wired
8L	460	2 - Ortronics Cat5e Data & 1-Rj45 Voice - Site Wired
9L	585	2 - Ortronics Cat6 Data & 1-Rj45 Voice - Site Wired

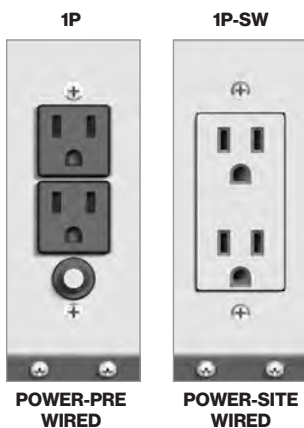

Model Number	List Price
1P	605
1P- SW	625

SINGLE MODULE FACEPLATE - POWER RECEPTACLES:

DESCRIPTION

Single module faceplate contains the following: 2 power receptacles 15A 120V pre wired with 10' cord and plug. Includes 12.5 amp overload protector.

Single module faceplate with - 1 duplex power receptacle/ 15A-120V. Comes with strain relief and 36" of metallic shielded cable wired to receptacle. Site Connection to power source required

***Face plate formerly labeled 2P has been changed to 1P-SW.**

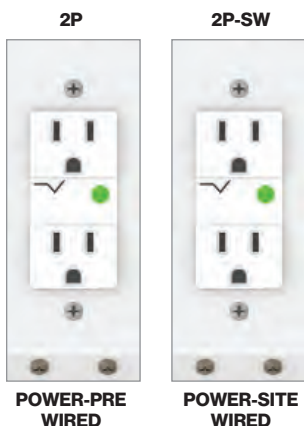

Model Number	List Price
2P	1,255
2P- SW	1,225

SINGLE MODULE FACEPLATE - POWER RECEPTACLES:

DESCRIPTION

Single module faceplate with - 1 duplex power receptacle/ 15A-120V. With Surge Suppressor -, 240 joules/ 15000a per mode and light. Prewired with 10' cord and plug.

Single module faceplate with - 1 duplex power receptacle/ 15A-120V. With surge suppressor, 240 joules/ 15000a per mode and light. Comes with strain relief and 36" of metallic shielded cable wired to receptacle. Site Connection to power source required

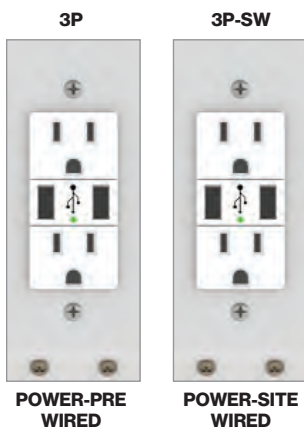

Model Number	List Price
3P	1,040
3P- SW	1,010

SINGLE MODULE FACEPLATE - POWER RECEPTACLES:

DESCRIPTION

Single module faceplate with - 1 duplex power receptacle/ 15A-120V. With 2 USB ports 3 Amp/ 5VDC Type a 2.0. Pre wired with 10' cord & plug

Single module faceplate with - 1 duplex power receptacle/ 15A-120V. With 2 USB ports 3 Hubbell/ 5VDC Type a 2.0. Comes with strain relief and 36" of metallic shielded cable wired to receptacle. Site Connection to power source required



Model Number	List Price
4P	1,200
4P- SW	1,155

SINGLE MODULE FACEPLATE - POWER RECEPTACLES:

DESCRIPTION

Single module faceplate with - 1 duplex power receptacle/ 15A-120V. With USB A + C charging (5V, 5A) 55W. Pre wired with 10' cord & plug

Single module faceplate with - 1 duplex power receptacle/ 15A-120V. With USB A + C charging (5V, 5A) 55W. With 36" metallic shielded cable wired to receptacle. Site connection to power source required

5P



POWER-PRE WIRED

5P-SW



POWER-SITE WIRED

SINGLE MODULE FACEPLATE - POWER RECEPTACLES:

Model Number	List Price
--------------	------------

5P	1,380
----	-------

5P-SW	1,335
-------	-------

DESCRIPTION

Single module faceplate contains the following: 1 duplex power receptacle 15A-120V, with USB C+C charging (5V, 5A) 55W and pre wired 10' cord

Single module faceplate contains the following: 1 duplex power receptacle 15A-120V, with USB C+C charging (5V, 5A) 55W and 36" metallic shielded cable wired to receptacle. Site connection to power source required.

OT - 9T



SINGLE MODULE FACEPLATE:

Model Number	List Price	Pre Wired – All Cords Terminated With Male Plugs
--------------	------------	--

0T	515	1 - Hubbell Cat5e Data, 10' Cord
1T	700	1 - Hubbell Cat6 Data, 10' Cord
2T	605	1 - Leviton Cat5e Data, 10' Cord
3T	700	1 - Leviton Cat6 Data, 10' Cord
4T	605	1 - Siemon Cat5e Data, 16' Cord
5T	700	1 - Siemon Cat6 Data, 16' Cord
6T	605	1 - Belden Cat5e Data, 10' Cord
7T	700	1 - Belden Cat6 Data, 10' Cord
8T	675	1 - Ortronics Cat5e Data, 10' Cord
9T	695	1 - Ortronics Cat6 Data, 10' Cord

DESCRIPTION

Single module faceplate contains the following:
 1 - HD-DB15 (female) with 18" cord and male plug.
 1 - 3.5mm stereo with 18" cord and male plug.
 1 - DATA (OT-9T) with 10' cord and male plug.

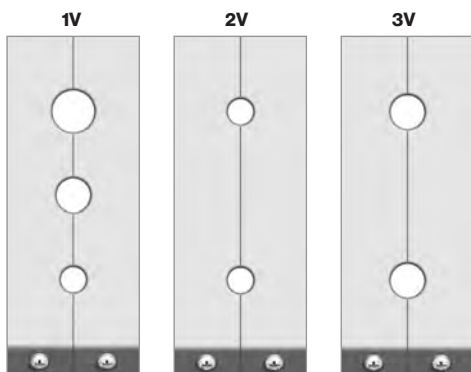

Model Number	List Price
1V	125
2V	125
3V	125

SINGLE MODULE FACEPLATE:

DESCRIPTION

Single module split plate assembly contains the following: 3 cutouts - inside diameter sizes - 3/8", 1/2", 5/8" for pass-through cable requirements.

Single module split faceplate contains the following: 2 cutouts - inside diameter sizes - 3/8" for pass-through cable requirements.

Single module split faceplate contains the following: 2 cutouts - inside diameter sizes - 1/2" for pass-through cable requirements.

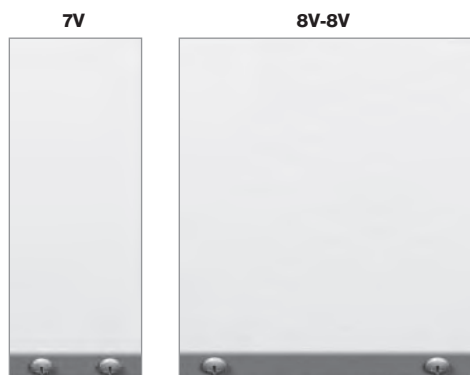

Model Number	List Price
7V	105
8V-8V	125

BLANK FACEPLATES:

DESCRIPTION

Single module blank faceplate

Double module blank faceplate

single module

double module

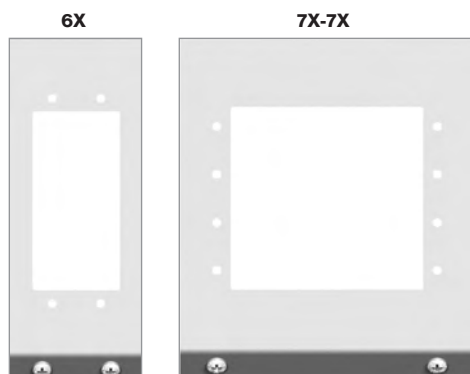

Model Number	List Price
6X	125
7X-7X	150

EXTRON "AAP" SERIES

DESCRIPTION

Single module adopter
-holds two Extron "AAP" modules in vertical position

Double module adopter
-holds four Extron "AAP" modules in horizontal position

Please refer to your Extron product catalogue for specific "AAP" module model numbers available

single module
vertical
alignment

double module
horizontal
alignment

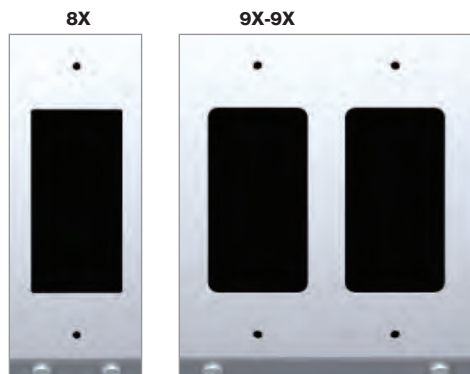

Model Number	List Price
8X	125
9X-9X	150

DECORA® INSERT PLATES

Single module, holds 1 Decora style insert (supplied by others)

Double module, holds 2 Decora style inserts (supplied by others)

single module

double module

"M & N" SERIES VOX® FORUM – MODULAR FACEPLATES



EXTRON RETRACTOR FACEPLATE/RETRACTOR INCLUDED:

(Note: Retractors provided; choose from list below)

Model Number	List Price
5R	470
6R-6R	650

5R Retractor Faceplate with R-01 VGA Retractor Series II	5R Retractor Faceplate with R-02 3.5mm Audio Retractor Series II	5R Retractor Faceplate with R-03 Data-CAT 6 Retractor Series II	5R Retractor Faceplate with R-04 HDMI Retractor Series II	5R Retractor Faceplate with R-05 USB (signal) Retractor Series II	5R Retractor Faceplate with R-06 VGA & Audio Retractor Series II	5R Retractor Faceplate with R-13 Display Port Retractor Series II	5R Retractor Faceplate with R-14 USB-C Pro 8K Retractor Series II

EXTRON RETRACTOR OPTIONS:

Model Number	List Price	Description
RA-02	280	Blank filler plate
SERIES 2		
R-01	1,560	VGA - Retractor series II - with 36" long cord
R-02	1,560	3.5mm audio - retractor series II - with 36" long cord
R-03	1,560	Data - CAT 6 - retractor series II - with 36" long cord
R-04	1,560	HDMI - retractor series II - with 36" long cord
R-05	1,560	USB (signal) - retractor series II - with 36" long cord / USB-A to USB-A
R-06	1,730	VGA & audio - retractor series II - with 36" long cord / VGA M-M & 3.5mm audio
R-13	1,730	Display Port - retractor series II - with 36" long cord
R-14	1,995	USB-C Pro 8K - retractor series II - with 36" long cord / USB-C to USB-C
SERIES 2 XL		
R-07	1,730	VGA - Retractor series II XL - with 60" long cord
R-08	1,730	3.5mm audio - retractor series II XL - with 60" long cord
R-09	1,730	Data - CAT 6 - retractor series II XL - with 60" long cord
R-10	1,730	HDMI - retractor series II XL - with 60" long cord
R-11	1,730	USB (signal) - retractor series II XL - with 60" long cord / USB-A to USB-A
R-12	1,905	VGA & audio - retractor series II XL - with 60" long cord / VGA M-M & 3.5mm audio
R-15	1,905	Display Port - retractor series II XL - with 60" long cord
R-14	2,170	USB-C Pro 8K XL - retractor series II - with 60" long cord / USB-C to USB-C

"M & N" SERIES VOX® FORUM – MODULAR FACEPLATES

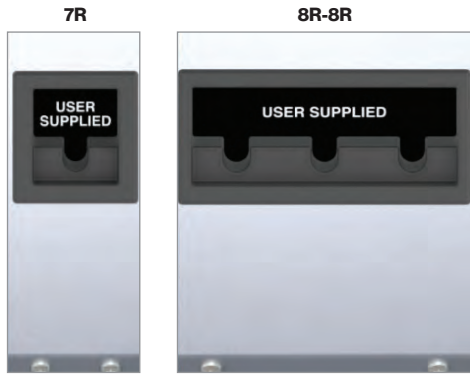

Model Number	List Price
7R	370
8R-8R	555

EXTRON RETRACTOR FACEPLATE/RETRACTOR NOT INCLUDED:
 (Note: Retractors to be provided and installed by others)

DESCRIPTION
Single faceplate holds 1 Extron Retractor
Double faceplate holds up to 3 Extron Retractors

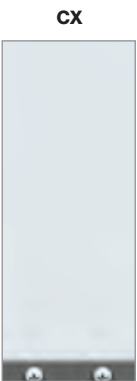

SINGLE CUSTOM MODULE FACEPLATE (SEE BELOW)

Model Number	List Price
CX	105

DESCRIPTION
 To build your Forum, select fittings from page 186.

HOW TO ORDER

1. From the list of jacks select the part number that describes your selection
2. Place the part number in one of three positions on the faceplate illustration "A", "B", or "C".
3. Fill in the associated List \$ of each fitting - total the cost.
4. Fill in the model number and transfer it to the proper position on the Forum order page 179 (6" Forum) or page 180 (12" Forum).
5. Add each modular plate price to complete the total Vox Forum list price.

Complete this for each custom plate required.

	Fitting Cost	
Position A	→ <input type="checkbox"/>	- _____
Position B	→ <input type="checkbox"/>	- _____
Position C	→ <input type="checkbox"/>	- _____
	<input type="checkbox"/> + \$105.00 plate cost	
=====		Total Cost
	Position A Position B Position C	
Model Number	CX - _____ - _____ - _____	

"M & N" SERIES VOX® FORUM FACEPLATE CUSTOM MODULE ORDER FORM



Part Number Pre-Wired List Price

Part Number Site-Wired List Price



A0	Hubbell - CAT 5E Data - 10' Cord	255
A1	Hubbell - CAT 6 Data - 10' Cord	460
A1A	Hubbell CAT 6A Data - 10' Cord	655



AX	Hubbell - CAT 5E Data - No Cord	200
A1X	Hubbell - CAT 6 Data - No Cord	310
A1AX	Hubbell - CAT 6A Data - No Cord	330



A2	Leviton - CAT 5E Data - 10' Cord	365
A3	Leviton - CAT 6 Data - 10' Cord	460
A3A	Leviton - CAT 6A Data - 10' Cord	730



A2X	Leviton - CAT 5E Data - No Cord	200
A3X	Leviton - CAT 6 Data - No Cord	310
A3AX	Leviton - CAT 6A Data - No Cord	370



A4	Siemon - CAT 5E Data - 16' Cord	365
A5	Siemon - CAT 6 Data - 16' Cord	460
A5A	Siemon - CAT 6A Data - 16' Cord	625



A4X	Siemon - CAT 5E Data - No Cord	200
A5X	Siemon - CAT 6 Data - No Cord	310
A5AX	Siemon - CAT 6A Data - No Cord	330



A6	Beldon - CAT 5E Data - 10' Cord	365
A7	Beldon - Cat 6 Data - 10' Cord	460
A7A	Beldon - CAT 6A Data - 10' Cord	615



A6X	Beldon - CAT 5E Data - No Cord	200
A7X	Beldon - CAT 6 Data - No Cord	310
A7AX	Beldon - CAT 6A Data - No Cord	330



A8	Ortronics - CAT 5E Data - 10' Cord	410
A9	Ortronics - CAT 6 Data - 10' Cord	455
A9A	Ortronics - CAT 6A Data - 10' Cord	640



A8X	Ortronics - CAT 5E Data - No Cord	200
A9X	Ortronics - CAT 6 Data - No Cord	290
A9AX	Ortronics - CAT 6A Data - No Cord	315
A11AX	Hubbell - CAT 6A Data - No Cord	330



B	Hubbell - Voice - 10' Cord	190
---	----------------------------	-----



BX	Hubbell - Voice - No Cord	175
----	---------------------------	-----



B1	Leviton - Voice - 10' Cord	365
----	----------------------------	-----



B1X	Leviton - Voice - No Cord	200
-----	---------------------------	-----



B2	Siemon - Voice - 10' Cord	365
----	---------------------------	-----



B2X	Siemon - Voice - No Cord	200
-----	--------------------------	-----



B3	Belden/ CDT - Voice - 10' Cord	365
----	--------------------------------	-----



B3X	Beldon - Voice - No Cord	200
-----	--------------------------	-----



B4	Ortronics - Voice - 10' Cord	410
----	------------------------------	-----



B4X	Ortronics - Voice - No Cord	200
-----	-----------------------------	-----



C	Audio - 3.5mm - 18" Cord	185
---	--------------------------	-----

O	Custom Fitting - No Cord Sample Req	145
---	-------------------------------------	-----



G	HD-DB15 - 18" Cord	290
---	--------------------	-----

P	Empty / No Fitting Required	
---	-----------------------------	--



H	USB - 24" Cord	225
---	----------------	-----



HB	USB Type B - 24" Cord	175
----	-----------------------	-----



HD	HDMI - 24" Cord	310
----	-----------------	-----



J1	XLR / 3 Pin / - 18" Cord	330
----	--------------------------	-----

**FACEPLATE CONNECTIONS ARE FEMALE, SUPPLY CORD PLUGS ARE MALE.
DB9 FACEPLATE FITTINGS ARE MALE, DB9 SUPPLY CORD PLUGS ARE FEMALE.**

THIS DOCUMENT IS CONFIDENTIAL AND PROPRIETARY. NO PART OF THIS DRAWING MAY BE COPIED OR DISCLOSED TO ANY THIRD PARTY OR USED FOR ANY PURPOSE WITHOUT THE EXPRESS WRITTEN AUTHORIZATION OF NIENKÄMPER INTERNATIONAL INC.



VOX® DOUBLE SIDED FORUM

INTRODUCTION



Standard Features

The Vox® Double-Sided Forum features a multi-directional hinged lid, providing access from either side of the table. The Forum sits flush with the tabletop, and the lid matches the work surface finish. A thin aluminum bezel lines the cutout in both the tabletop and lid for added durability and a color detail.

The Vox® Double-Sided Forum is available in a 4-module configuration. Modules can be specified as Power/Charging, Data/AV, Split Plates, or Retractors. Modules can be swapped or repositioned on site if your power or AV requirements change.

Power modules include:

3 simplexes, or 2 simplexes with USB-A or USB-C charging

Power units are available with a pre-wired cord, hardwired feed, or daisy-chain feed.

Data/AV plates contain 4 fittings. Individual fittings can be swapped out, or the entire plate can be replaced on site as needed.

FINISHES

The Vox® Double-Sided Forum is constructed from sturdy aluminum and finished with a durable powder coat. The body is available in Black, Gray, or White powder coat. The lid is matched to the veneer, plastic laminate or engineered stone used on the tabletop for a seamless look.

Custom powder coat colors are available upon request; please note that this may affect pricing and lead times. Contact Nienkamper Customer Service at **800.668.9318**.

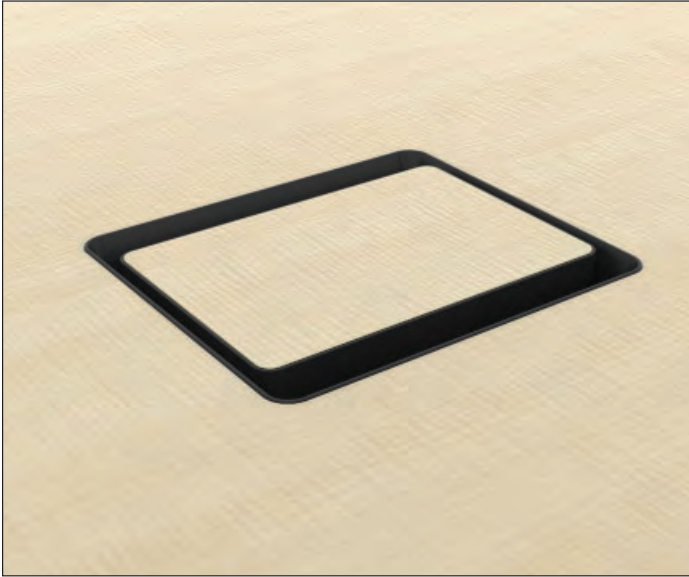

BLACK

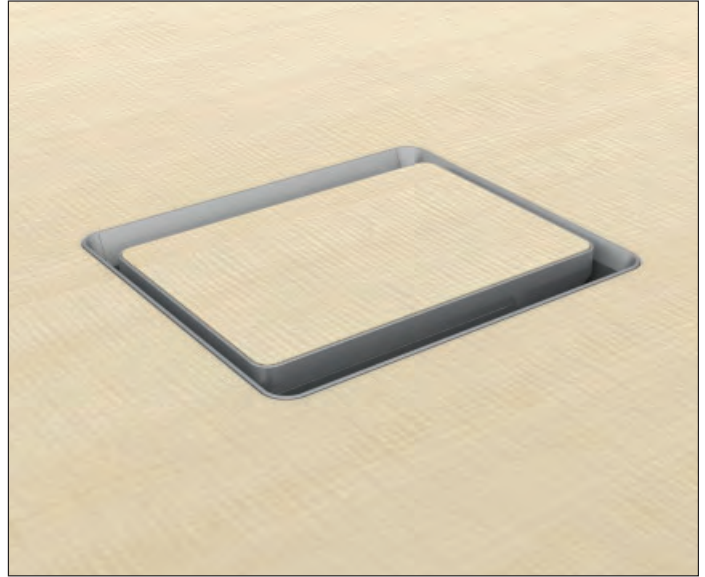

GRAY



WHITE



CUSTOM

VOX® DOUBLE SIDED FORUM - ORDER FORM

THE VOX® DOUBLE SIDED FORUM HAS 4 PORTS THAT CAN BE POPULATED WITH VARIOUS FACE PLATES.

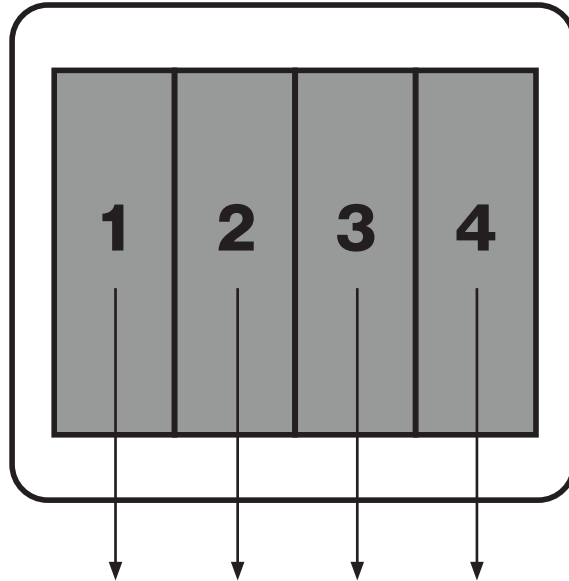

Base Model# - G-

_____ - _____ - _____ - _____
 PLATE 1 PLATE 2 PLATE 3 PLATE 4

- Select the modular faceplate required from pages 241-243.
- Fill in the 2 digit model number of each plate in the desired location.
- For custom modular plates, fill in "CX" as the model number.

\$970 + _____ + _____ + _____ + _____ = _____
 BASE MODEL COST PLATE #1 COST PLATE #2 COST PLATE #3 COST PLATE #4 COST

• Add up the cost

*Base model cost includes finished veneer or plastic laminate lid.

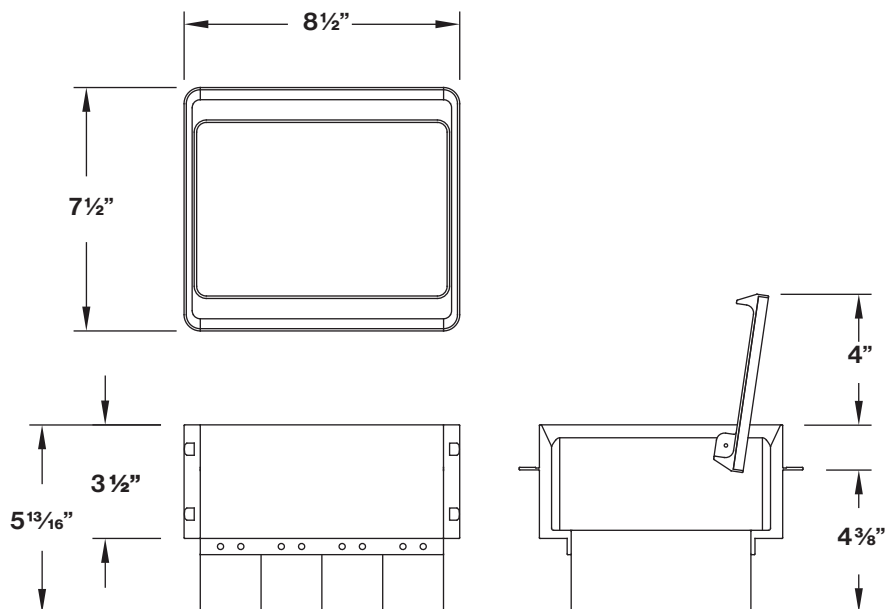

POWER FACEPLATES

DS-1P



Model Number	List Price
DS-1P	\$265
DS-1P-SW	\$300
DS-1P-4T	\$295

DESCRIPTION

- Single module faceplate contains 3 power receptacles 15A 120V
- Pre wired with a 10' cord.
- Site wired with a 72" metallic shielded cable.
- Site connection to power source required.
- Comes with a daisy chain wire system that runs on two circuits
- Site connection to power source required.

DS-2P



Model Number	List Price
DS-2P	\$365
DS-2P-SW	\$410
DS-2P-4T	\$400

DESCRIPTION

- Single module faceplate contains 2 power receptacles 15A 120V,
- 2 USB-A, with 2 Amps per port.
- Pre wired with a 10' cord.
- Site wired with a 72" metallic shielded cable.
- Site connection to power source required.
- Comes with a daisy chain wire system that runs on two circuits
- Site connection to power source required.

POWER FACEPLATES

DS-3P



MODEL NUMBER	LIST PRICE
DS-3P	\$365
DS-3P-SW	\$410
DS-3P-4T	\$400

DESCRIPTION

- Single module faceplate contains 2 power receptacles 15A 120V,
- USB-A+C, with 2 Amps per port 18W.
- Pre wired with a 10' cord.
- Site wired with a 72" metallic shielded cable.
- Site connection to power source required.
- Comes with a daisy chain wire system that runs on two circuits
- Site connection to power source required.

DS-4P

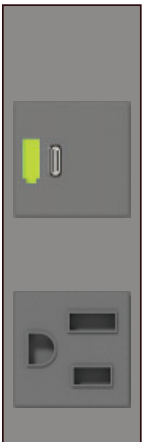

MODEL NUMBER	LIST PRICE
DS-4P	\$555
DS-4P-SW	\$605
DS-4P-4T	\$595

DESCRIPTION

- Single module faceplate contains 1 power receptacle 15A 120V,
- 1 USB-C, with 100W
- Pre wired with a 10' cord.
- Site wired with a 72" metallic shielded cable.
- Site connection to power source required.
- Comes with a daisy chain wire system that runs on two circuits
- Site connection to power source required.

SPLIT PLATE

DS-SP

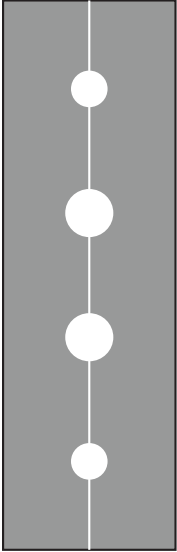

MODEL NUMBER	LIST PRICE
DS-SP	\$100
	PLATE ONLY

DESCRIPTION

- Split plate has 2 openings that are 3/8" diameter and 2 openings at 7/16" diameter.

BLANK PLATE

DS-BP

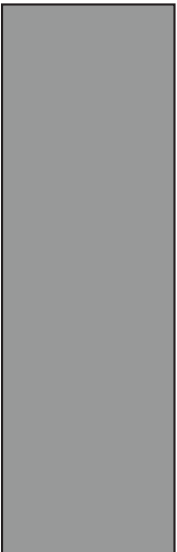

MODEL NUMBER	LIST PRICE
DS-BP	\$100
	PLATE ONLY

DESCRIPTION

- Blank plate used as filler within Forum.

CUSTOM AV/DATA FACE-PLATES

DS-CX

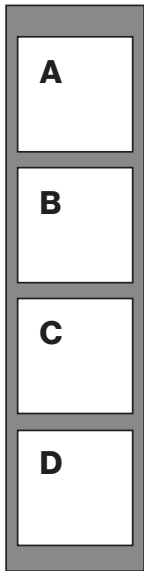

MODEL NUMBER

POSITION A

POSITION B

POSITION C

POSITION D

+ \$100 PLATE COST

DESCRIPTION

The CX plate has 4 spaces for fittings and can be used in any position in the forum.

MODEL NUMBER	CX-			
	POSITION A	POSITION B	POSITION C	POSITION D



A5 \$190

SIEMON CAT 6 data fitting with 10' connector cable (Female to Male)



C \$95

Audio- 3.5mm Mini stereo Jack with 10' cord (Female to Male)



H \$145

USB port 3.0 with 10' cord (Female to Male)



G \$205

DB15HD, VGA connector, 10' cord (Female to Male)



HD \$205

HDMI coupler (female to female) with 18" cord



B \$70

Blank Plate

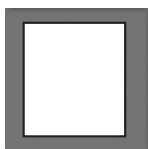

O \$70

Open port for clients own data fitting. Each port selected will be supplied with one set of data adapter kit.

RETRACTOR FACE-PLATES

DS-6R

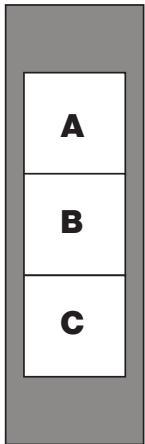

MODEL NUMBER	LIST PRICE
DS-6R	\$100
PLATE ONLY	

DESCRIPTION

- Extron Retractor faceplate fits 3 Extron retractors. The 6R retractor faceplate can only be placed in position 1 and 4 on the G forum.
- Retractors can be bought through Nienkämper or Users can supply there own Extron retractor components. *See page 246 for req'd Filler Module.
- Note: This plate holds 3 Extron Retractors. Any spot not using a retractor will require a filler module. If client is suppling there own retractors order filler model #70-1065-35.

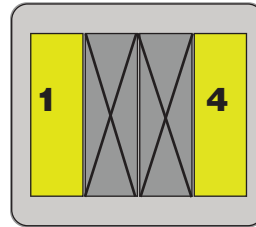

R-01 **\$1,560**

VGA - Retractor series II - with 36" long cord.



R-03 **\$1,560**

Data - CAT 6 - retractor series II - with 36" long cord



R-05 **\$1,560**

USB (signal) - retractor series II - with 36" long cord / USB-A to USB-A



R-13 **\$1,730**

Display Port - retractor series II - with 36" long cord



R-15 **\$1,905**

Display Port - retractor series II - with 60" long cord



R-02 **\$1,560**

3.5mm audio - retractor series II - with 36" long cord



R-08 **\$1,730**

3.5mm audio - retractor series II - with 60" long cord



R-04 **\$1,560**

HDMI - retractor series II - with 36" long cord



R-10 **\$1,730**

HDMI - retractor series II - with 60" long cord

R-06 **\$1,730**

VGA & Audio - retractor series II - with 36" long cord / VGA M-M & 3.5mm audio

R-12 **\$1,905**

VGA & audio - retractor series II - with 60" long cord / VGA M-M & 3.5mm audio

R-14 **\$1,995**

USB-C Pro 8K - retractor series II - with 36" long cord / USB-C to USB-C

R-16 **\$2,170**

USB-C Pro 8K - retractor series II - with 60" long cord / USB-C to USB-C

SPLIT PLATE

DS-FM



MODEL NUMBER	LIST PRICE
DS-FM	\$190

DESCRIPTION

- A Filler Module is required if less than 3 Extron retractors are ordered on each Plate 1 & Plate 4.
- A Filler Module is required for clients supplying their own retractors.

FORUMS

M & N SERIES FORUM

M & N Series Forum are available in a wide range of configurations for power, data and audio/video requirement. Configure your require M & N Series Forum on our web site at this link www.nienkämper.com/vfc



SIMPLE POP UP FORUM - Single sided (Surface mounted)

List Price

Pre-configured SIMPLE Pop Up Forum

Model # 85190	pre-wired power (2 ports)	<table border="1"><tr><td>1P</td><td>1P</td></tr></table>	1P	1P	\$660		
1P	1P						
		cutout dimension: 5"W x 4"D 2 x pre-wired power with 10ft cord					
Model # 85191	pre-wired power (3 ports)	<table border="1"><tr><td>1P</td><td>1P</td><td>1P</td></tr></table>	1P	1P	1P	\$680	
1P	1P	1P					
		cutout dimension: 6 1/2"W x 4"D 3 x pre-wired power with 10ft cord					
Model # 85193	pre-wired power (3 ports)	<table border="1"><tr><td>1P</td><td>1P</td><td>A5</td></tr></table>	1P	1P	A5	\$810	
1P	1P	A5					
		cutout dimension: 6 1/2"W x 4"D 2 x pre-wired power with 10ft cord 1 x Siemon CAT6 data with 10ft cord					
Model # 85197	pre-wired power (3 ports)	<table border="1"><tr><td>1P</td><td>1P</td><td>O</td></tr></table>	1P	1P	O	\$680	
1P	1P	O					
		cutout dimension: 6 1/2"W x 4"D 2 x pre-wired power with 10ft cord 1 x open port / data adapter to fit in client's own data fitting and cord					
Model # 85194	pre-wired power (3 ports)	<table border="1"><tr><td>1P</td><td>1P</td><td>2U</td></tr></table>	1P	1P	2U	\$775	
1P	1P	2U					
		cutout dimension: 6 1/2"W x 4"D 2 x pre-wired power with 10ft cord 2 x USB-A+C charger (stacked)					
Model # 85196	pre-wired power (4 ports)	<table border="1"><tr><td>1P</td><td>1P</td><td>A5</td><td>A5</td></tr></table>	1P	1P	A5	A5	\$930
1P	1P	A5	A5				
		cutout dimension: 8"W x 4"D 2 x pre-wired power with 10ft cord 2 x Siemon CAT6 data with 10ft cord					
Model # 85198	pre-wired power (4 ports)	<table border="1"><tr><td>1P</td><td>1P</td><td>O</td><td>O</td></tr></table>	1P	1P	O	O	\$710
1P	1P	O	O				
		cutout dimension: 8"W x 4"D 2 x pre-wired power with 10ft cord 2 x open port / data adapter to fit in client's own data fitting and cord					

FORUMS

List Price

Model # 85199	pre-wired power (4 ports)	<table border="1"> <tr> <td>1P</td> <td>1P</td> <td>2U</td> <td>HD</td> </tr> </table> <p>cutout dimension: 8"W x 4"D 2 x pre-wired power with 10ft cord 2 x USB-A+C charger (stacked) 1 x HDMI coupler with 18" cord</p>	1P	1P	2U	HD	\$955		
1P	1P	2U	HD						
Model # 85200	pre-wired power (4 ports)	<table border="1"> <tr> <td>1P</td> <td>1P</td> <td>2U</td> <td>O</td> </tr> </table> <p>cutout dimension: 8"W x 4"D 2 x pre-wired power with 10ft cord 2 x USB-A+C charger (stacked) 1 x open port / data adapter to fit in client's own data fitting and cord</p>	1P	1P	2U	O	\$830		
1P	1P	2U	O						
Model # 85202	pre-wired power (6 ports)	<table border="1"> <tr> <td>1P</td> <td>1P</td> <td>2U</td> <td>HD</td> <td>A5</td> <td>A5</td> </tr> </table> <p>cutout dimension: 11"W x 4"D 2 x pre-wired power with 10ft cord 2 x USB-A+C charger (stacked) 1 x HDMI coupler with 18" cord 2 x Siemon CAT6 data with 10ft cord</p>	1P	1P	2U	HD	A5	A5	\$1,290
1P	1P	2U	HD	A5	A5				
Model # 85203	pre-wired power (6 ports)	<table border="1"> <tr> <td>1P</td> <td>1P</td> <td>2U</td> <td>HD</td> <td>O</td> <td>O</td> </tr> </table> <p>cutout dimension: 11"W x 4"D 2 x pre-wired power with 10ft cord 2 x USB-A+C charger (stacked) 1 x HDMI coupler with 18" cord 2 x open port/ data adapter to fit in client's own data fitting and cord</p>	1P	1P	2U	HD	O	O	\$1,030
1P	1P	2U	HD	O	O				

FORUMS - SIMPLE POP UP FORUM



SIMPLE POP UP FORUM – DOUBLE SIDED (SURFACE MOUNTED)

List Price

Pre-configured SIMPLE Pop Up Forum

Model # 85205	pre-wired power (each side - 2 ports)	Side A: <table border="1"><tr><td>1P</td><td>1P</td></tr></table> Side B: <table border="1"><tr><td>1P</td><td>1P</td></tr></table>	1P	1P	1P	1P	\$1,335				
1P	1P										
1P	1P										
		cutout dimension: 5"W x 7-11/16"D Side A: 2 x pre-wired power with 10ft cord Side B: 2 x pre-wired power with 10ft cord (Provides a total of 4 x pre wired power)									
Model # 85206	pre-wired power (each side - 3 ports)	Side A: <table border="1"><tr><td>1P</td><td>1P</td><td>2U</td></tr></table> Side B: <table border="1"><tr><td>1P</td><td>1P</td><td>2U</td></tr></table>	1P	1P	2U	1P	1P	2U	\$1,665		
1P	1P	2U									
1P	1P	2U									
		cutout dimension: 6-1/2"W x 7-11/16"D Side A: 2 x pre-wired power with 10ft cord 2 x USB-A+C Charger (stacked) Side B: 2 x pre-wired power with 10ft cord 2 x USB-A+C Charger (stacked) (Provides a total of 4 x pre wired power & 4 x USB Charger)									
Model # 85208	pre-wired power (each side - 4 ports)	Side A: <table border="1"><tr><td>1P</td><td>1P</td><td>A5</td><td>A5</td></tr></table> Side B: <table border="1"><tr><td>1P</td><td>1P</td><td>A5</td><td>A5</td></tr></table>	1P	1P	A5	A5	1P	1P	A5	A5	\$1,885
1P	1P	A5	A5								
1P	1P	A5	A5								
		cutout dimension: 8"W x 7-11/16"D Side A: 2 x pre-wired power with 10ft cord 2 x Siemon CAT6 data with 10ft cord Side B: 2 x pre-wired power with 10ft cord 2 x Siemon CAT6 data with 10ft cord (Provides a total of 4 x pre wired power & 4 x Siemon CAT6 data)									

FORUMS - SIMPLE POP UP FORUM

List Price

Model # 85209 pre-wired power
(each side - 4 ports)

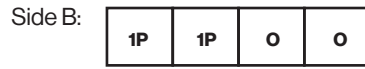

cutout dimension: 8"W x 7-11/16"D

Side A: 2 x pre-wired power with 10ft cord

2 x open port/data adapter to fit in client's own data fitting and cord

Side B: 2 x pre-wired power with 10ft cord

2 x open port/data adapter to fit in client's own data fitting and cord

(Provides a total of 4 x pre wired power & 4 x open ports)

\$1,375

Model # 85210 pre-wired power
(each side - 4 ports)

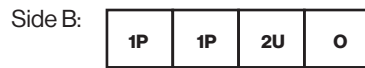

cutout dimension: 8"W x 7-11/16"D

Side A: 2 x pre-wired power with 10ft cord,

2 x USB-A+C Charger (stacked)

1 x open port/ data adapter to fit in client's own data fitting and cord

Side B: 2 x pre-wired power with 10ft cord,

2 x USB-A+C Charger (stacked)

1 x open port/ data adapter to fit in client's own data fitting and cord

(Provides a total of 4 x pre wired power, 4 x USB Charger & 2 x open ports)

\$1,690

FORUMS - SIMPLE POP UP FORUM

- Note:
- Finish is standard in clear anodized aluminum.
 - For power cord with 6ft long, please add a letter "B" at the end of model #.
 - Site-wired / hard-wired power with 72" metallic shielded cable is available with an upcharge of \$95 list per 2 power. Please add a letter "H" at the end of model #.
-

Each open port selected will be supplied with one set of data adapter kit contains 2 "AA", 2 "BB", 2 "CC", 2 "DD", 2 "EE", 2 "FF", 1 "GG" and 1 "HH". adapter. The data adapter can accommodate the following data fitting from manufacturer:

Adapter "AA"

Systimax/CommScope
Uniprise/CommScope

Adapter "BB"

L-Com Keystone Modular
Tyco SL/110 Connect Series Modular Jacks
Siemon Keystone Style
Allen Tel Versa Tap Series
Leviton Quick Port® Series
Nordx Keystone Style
Tyco SL Conpler Series

Adapter "CC"

Krone 6000 Series/ADC
Hubbell Xcelerator™ Keystone
Series

Adapter "DD"

blank

Adapter "EE"

Ortronics TracJack Series

Adapter "FF"

Panduit Mini-Com Series

Adapter "GG"

microphone jack / 3pin XLR, solder type
only

Adapter "HH"

Adapter "HH" - video monitor jack / DB-15,
pand mount solder type.

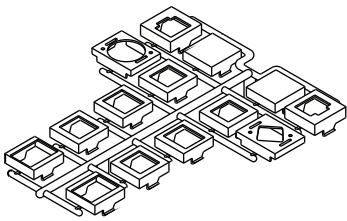

- Snap in fitting adapters are also provide for 3-pin XLR microphone jack (solder type only) and DB-15 video monitor jack (panel mount solder style only)
-

FORUMS - SIMPLE POP UP FORUM

List Price

To create a unique Vox® SIMPLE Pop Up Forum configuration, simply choose a base model and select the required elements.

Base Model For Simple Pop Up Forum

(4 Ports)

Model #: CX4P - _____

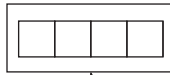

\$575

Base Model For Simple Pop Up Forum

(6 Ports)

Model #: CX6P - _____

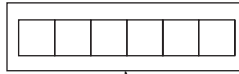

\$650

Base Model For Simple Pop Up Forum – Double Sided

(Each Side – 4 Ports)





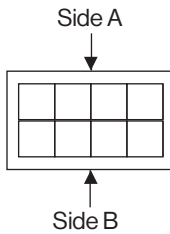







Model #: CX8PD-A _____ (Side A)

CX8PD-B _____ (Side B)



\$1,210

Select the elements as per below:

	S-1P - 1 power receptacle with 10' white cord	\$155
	S-1P-SW - 1 power receptacle hard wired with a 6' whip	\$175
	A5 - SIEMON CAT 6 data fitting with 10' connector cable	\$190
	C - Audio- 3.5mm Mini stereo Jack with 10' cord	\$95
	H - USB port 3.0 with 10ft cord	\$145
	2U - Stacked USB charger A+C	\$180
	3U - Dual USB C charger	\$180
	G - DB15HD, VGA connector, 10' cord	\$205
	HD - HDMI Coupler with 18" cord	\$205
	B - Blank plate	\$70
	O - Open port, for client's own data fitting. Each port selected will be supplied with one set of data adapter kit	\$70
	L - Belay 1" dia. hole opening rubber strain relief pass through cords	\$70

FORUMS - SIMPLE FORUM

SIMPLE FORUM – SINGLE SIDED (SURFACE MOUNTED)

List Price

Pre-configured SIMPLE Forum (4 ports 6¾” L x 2” W)

Model # 39956/6	pre-wired power	<table border="1"><tr><td>1P</td><td>1P</td><td>A5</td><td>A5</td></tr></table>	1P	1P	A5	A5	\$710
1P	1P	A5	A5				
		2 x pre-wired power with 10ft cord 2 x SIEMON CAT6 data with 10ft cord					
Model # 39957/6	site-wired power	<table border="1"><tr><td>1P-SW</td><td>1P-SW</td><td>A5</td><td>A5</td></tr></table>	1P-SW	1P-SW	A5	A5	\$750
1P-SW	1P-SW	A5	A5				
		2 x site-wired power with 6ft metallic shielded cable 2 x SIEMON CAT6 data with 10ft cord					
Model # 39958/6	pre-wired power	<table border="1"><tr><td>1P</td><td>1P</td><td>2U</td><td>A5</td></tr></table>	1P	1P	2U	A5	\$805
1P	1P	2U	A5				
		2 x pre-wired power with 10ft cord 1 x stacked USB charger A+C 1 x SIEMON CAT6 data with 10ft cord					
Model # 39959/6	site-wired power	<table border="1"><tr><td>1P-SW</td><td>1P-SW</td><td>2U</td><td>A5</td></tr></table>	1P-SW	1P-SW	2U	A5	\$830
1P-SW	1P-SW	2U	A5				
		2 x site-wired power with 6ft metallic shielded cable 1 x stacked USB charger A+C 1 x SIEMON CAT6 data with 10ft cord;					
Model # 39961/6	pre-wired power	<table border="1"><tr><td>1P</td><td>1P</td><td>A5</td><td>HD</td></tr></table>	1P	1P	A5	HD	\$775
1P	1P	A5	HD				
		2 x pre-wired power with 10ft cord 1 x SIEMON CAT6 data with 10ft cord 1 x HDMI coupler with 18” cord					
Model # 39962/6	site-wired power	<table border="1"><tr><td>1P-SW</td><td>1P-SW</td><td>A5</td><td>HD</td></tr></table>	1P-SW	1P-SW	A5	HD	\$805
1P-SW	1P-SW	A5	HD				
		2 x site-wired power with 6ft metallic shielded cable 1 x SIEMON CAT6 data with 10ft cord; 1 x HDMI coupler with 18” cord					

FORUMS - SIMPLE FORUM

SIMPLE FORUM – SINGLE SIDED (SURFACE MOUNTED)

List Price

Pre-configured SIMPLE Forum (4 ports, 6³/₄" L x 2" W)

Model # 39963	pre-wired power	<table border="1"><tr><td>1P</td><td>1P</td><td>H</td><td>HD</td></tr></table>	1P	1P	H	HD	\$720
1P	1P	H	HD				
		2 x pre-wired power with 10ft cord 1 x USB port 3.0 with 10ft cord 1 x HDMI coupler with 18" cord					
Model # 39964	site-wired power	<table border="1"><tr><td>1P-SW</td><td>1P-SW</td><td>H</td><td>HD</td></tr></table>	1P-SW	1P-SW	H	HD	\$755
1P-SW	1P-SW	H	HD				
		2 x site-wired power with 6ft metallic shielded cable 1 x USB port 3.0 with 10ft cord 1 x HDMI coupler with 18" cord					

FORUMS - SIMPLE FORUM

SIMPLE FORUM – SINGLE SIDED (SURFACE MOUNTED)

List Price

Pre-configured SIMPLE Forum (4 ports, for client's own data fitting)

Model # 39956	pre-wired power	<table border="1"><tr><td>1P</td><td>1P</td><td>0</td><td>0</td></tr></table>	1P	1P	0	0	\$550
1P	1P	0	0				
		2 x pre-wired power with 10ft cord 2 x open port / data adapter to fit in client's own data fitting & cord					
Model # 39957	site-wired power	<table border="1"><tr><td>1P-SW</td><td>1P-SW</td><td>0</td><td>0</td></tr></table>	1P-SW	1P-SW	0	0	\$575
1P-SW	1P-SW	0	0				
		2 x site-wired power with 6ft metallic shielded cable 2 x open port / data adapter to fit in client's own data fitting & cord					
Model # 39958	pre-wired power	<table border="1"><tr><td>1P</td><td>1P</td><td>2U</td><td>0</td></tr></table>	1P	1P	2U	0	\$680
1P	1P	2U	0				
		2 x pre-wired power with 10ft cord 1 x stacked USB charger A+C 1 x open port					
Model # 39959	site-wired power	<table border="1"><tr><td>1P-SW</td><td>1P-SW</td><td>2U</td><td>0</td></tr></table>	1P-SW	1P-SW	2U	0	\$710
1P-SW	1P-SW	2U	0				
		2 x site-wired power with 6ft metallic shielded cable 1 x stacked USB charger A+C 1 x open port					
Model # 39961	pre-wired power	<table border="1"><tr><td>1P</td><td>1P</td><td>0</td><td>HD</td></tr></table>	1P	1P	0	HD	\$720
1P	1P	0	HD				
		2 x pre-wired power with 10ft cord 1 x open port 1 x HDMI coupler with 18" cord					
Model # 39962	site-wired power	<table border="1"><tr><td>1P-SW</td><td>1P-SW</td><td>0</td><td>HD</td></tr></table>	1P-SW	1P-SW	0	HD	\$755
1P-SW	1P-SW	0	HD				
		2 x site-wired power with 6ft metallic shielded cable 1 x open port 1 x HDMI coupler with 18" cord					

FORUMS - SIMPLE FORUM

SIMPLE FORUM – SINGLE SIDED (SURFACE MOUNTED)

List Price

Pre-configured SIMPLE Forum (6 ports 9³/₄" L x 2" W)

Model # 39941/6	pre-wired power	<table border="1"><tr><td>1P</td><td>1P</td><td>A5</td><td>A5</td><td>B</td><td>B</td></tr></table> <p>2 x pre-wired power with 10ft cord 2 x SIEMON CAT6 data with 10ft cord 2 x blank plate</p>	1P	1P	A5	A5	B	B	\$855
1P	1P	A5	A5	B	B				
Model # 39942/6	site-wired power	<table border="1"><tr><td>1P-SW</td><td>1P-SW</td><td>A5</td><td>A5</td><td>B</td><td>B</td></tr></table> <p>2 x site-wired power with 6ft metallic shielded cable 2 x SIEMON CAT6 data with 10ft cord 2 x blank plate</p>	1P-SW	1P-SW	A5	A5	B	B	\$925
1P-SW	1P-SW	A5	A5	B	B				
Model # 39943/6	pre-wired power	<table border="1"><tr><td>1P</td><td>1P</td><td>A5</td><td>A5</td><td>G</td><td>C</td></tr></table> <p>2 x pre-wired power with 10ft cord 2 x SIEMON CAT6 data with 10ft cord 1 x HD-DB15/VGA connector with 10ft cord 1 x audio 3.5mm mini stereo jack with 10 ft cord</p>	1P	1P	A5	A5	G	C	\$1,035
1P	1P	A5	A5	G	C				
Model # 39944/6	site-wired power	<table border="1"><tr><td>1P-SW</td><td>1P-SW</td><td>A5</td><td>A5</td><td>G</td><td>C</td></tr></table> <p>2 x site-wired power with 6ft metallic shielded cable 2 x SIEMON CAT6 data with 10ft cord 1 x HD-DB15/VGA connector with 10ft cord 1 x audio 3.5mm mini stereo jack with 10ft cord</p>	1P-SW	1P-SW	A5	A5	G	C	\$1,115
1P-SW	1P-SW	A5	A5	G	C				

FORUMS - SIMPLE FORUM

SIMPLE FORUM – SINGLE SIDED (SURFACE MOUNTED)

List Price

Pre-configured SIMPLE Forum (6 ports 9³/₄" L x 2" W)

Model # 39945/6	pre-wired power	<table border="1"><tr><td>1P</td><td>1P</td><td>A5</td><td>A5</td><td>HD</td><td>H</td></tr></table> <p>2 x pre-wired power with 10ft cord 2 x SIEMON CAT6 data with 10ft cord 1 x HDMI coupler with 18" cord 1 x USB port 3.0 with 10ft cord</p>	1P	1P	A5	A5	HD	H	\$1,065
1P	1P	A5	A5	HD	H				
Model # 39946/6	site-wired power	<table border="1"><tr><td>1P-SW</td><td>1P-SW</td><td>A5</td><td>A5</td><td>HD</td><td>H</td></tr></table> <p>2 x site-wired power with 6ft metallic shielded cable 2 x SIEMON CAT6 data with 10ft cord; 1 x HDMI coupler with 18" cord 1 x USB port 3.0 with 10ft cord</p>	1P-SW	1P-SW	A5	A5	HD	H	\$1,135
1P-SW	1P-SW	A5	A5	HD	H				
Model # 39947/6	pre-wired power	<table border="1"><tr><td>1P</td><td>1P</td><td>1P</td><td>A5</td><td>A5</td><td>A5</td></tr></table> <p>3 x pre-wired power with 10ft cord 3 x SIEMON CAT6 data with 10ft cord</p>	1P	1P	1P	A5	A5	A5	\$1,015
1P	1P	1P	A5	A5	A5				
Model # 39948/6	site-wired power	<table border="1"><tr><td>1P-SW</td><td>1P-SW</td><td>1P-SW</td><td>A5</td><td>A5</td><td>A5</td></tr></table> <p>3 x site-wired power with 6ft metallic shielded cable 3 x SIEMON CAT6 data with 10ft cord</p>	1P-SW	1P-SW	1P-SW	A5	A5	A5	\$1,080
1P-SW	1P-SW	1P-SW	A5	A5	A5				

FORUMS - SIMPLE FORUM

SIMPLE FORUM – SINGLE SIDED (SURFACE MOUNTED)

List Price

Pre-configured SIMPLE Forum (6 ports, for client's own data fitting)

Model # 39951	pre-wired power	<table border="1" style="border-collapse: collapse; width: 100%;"> <tr> <td style="padding: 2px 10px;">1P</td> <td style="padding: 2px 10px;">1P</td> <td style="padding: 2px 10px;">O</td> <td style="padding: 2px 10px;">O</td> <td style="padding: 2px 10px;">O</td> <td style="padding: 2px 10px;">O</td> </tr> </table>	1P	1P	O	O	O	O	\$625
1P	1P	O	O	O	O				
		<p>2 x pre-wired power with 10ft cord 4 x open port/data adapter to fit in client's own data fitting and cord</p>							
Model # 39952	site-wired power	<table border="1" style="border-collapse: collapse; width: 100%;"> <tr> <td style="padding: 2px 10px;">1P-SW</td> <td style="padding: 2px 10px;">1P-SW</td> <td style="padding: 2px 10px;">O</td> <td style="padding: 2px 10px;">O</td> <td style="padding: 2px 10px;">O</td> <td style="padding: 2px 10px;">O</td> </tr> </table>	1P-SW	1P-SW	O	O	O	O	\$660
1P-SW	1P-SW	O	O	O	O				
		<p>2 x site-wired power with 6ft metallic shielded cable 4 x open port/data adapter to fit in client's own data fitting and cord</p>							
Model # 39953	pre-wired power	<table border="1" style="border-collapse: collapse; width: 100%;"> <tr> <td style="padding: 2px 10px;">1P</td> <td style="padding: 2px 10px;">1P</td> <td style="padding: 2px 10px;">1P</td> <td style="padding: 2px 10px;">O</td> <td style="padding: 2px 10px;">O</td> <td style="padding: 2px 10px;">O</td> </tr> </table>	1P	1P	1P	O	O	O	\$650
1P	1P	1P	O	O	O				
		<p>3 x pre-wired power with 10ft cord 3 x open port/data adapter to fit in client's own data fitting and cord</p>							
Model # 39954	site-wired power	<table border="1" style="border-collapse: collapse; width: 100%;"> <tr> <td style="padding: 2px 10px;">1P-SW</td> <td style="padding: 2px 10px;">1P-SW</td> <td style="padding: 2px 10px;">1P-SW</td> <td style="padding: 2px 10px;">O</td> <td style="padding: 2px 10px;">O</td> <td style="padding: 2px 10px;">O</td> </tr> </table>	1P-SW	1P-SW	1P-SW	O	O	O	\$695
1P-SW	1P-SW	1P-SW	O	O	O				
		<p>3 x site-wired power with 6ft metallic shielded cable 3 x open port/data adapter to fit in client's own data fitting and cord</p>							

Each open port selected will be supplied with one set of data adapter kit contains 2 "AA", 2 "BB", 2 "CC", 2 "DD", 2 "EE", 2 "FF", 1 "GG" and 1 "HH". adapter. The data adapter can accommodate the following data fitting from manufacturer:

Adapter "AA"

Systemax/CommScope
Uniprise/CommScope

Adapter "BB"

L-Com Keystone Modular
Tyco SL/110 Connect Series Modular Jacks
Simon Keystone Style
Allen Tel Versa Tap Series
Leviton Quick Port® Series
Nordx Keystone Style
Tyco SL Conpler Series

Adapter "CC"

Krone 6000 Series/ADC
Hubbell Xcelerator™ Keystone Series

Adapter "DD"

blank

Adapter "EE"

Ortronics TracJack Series

Adapter "FF"

Panduit Mini-Com Series

Adapter "GG"

microphone jack / 3pin XLR, solder type only

Adapter "HH"

Adapter "HH" - video monitor jack / DB-15, panel mount solder type.

FORUMS - SIMPLE FORUM

CUSTOM SIMPLE FORUM

LIST PRICE

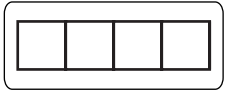

\$350

CX4- _____



\$375

CX6- _____

Select the elements as per below:

	S-1P - 1 power receptacle with 10' white cord	\$155
	S-1P-SW - 1 power receptacle hard wired with a 6' whip	\$175
	A5 - SIEMON CAT 6 data fitting with 10' connector cable	\$190
	C - Audio- 3.5mm Mini stereo Jack with 10' cord	\$95
	H - USB port 3.0 with 10ft cord	\$145
	2U - Stacked USB charger A+C	\$180
	3U - Dual USB C charger	\$180
	G - DB15HD, VGA connector, 10' cord	\$205
	HD - HDMI Coupler with 18" cord	\$205
	B - Blank plate	\$70
	O - Open port, for client's own data fitting. Each port selected will be supplied with one set of data adapter kit	\$70
	L - Belay 1" dia. hole opening rubber strain relief pass through cords	\$70
