

Number Explorer Missions



What if One was made of jelly, Two was made of cheese? Can you create a Numberblock with your next yummy snack?



What if Numberland was upside down? Find a way to look at the world upside down. Can you bend down and look through your legs?



Can you ask the What-iffer a question? Say whatever pops into your mind!



What if... you added as many zeros as you could to a number? Write 1, 10, 100, 1000- pretty soon you'll reach a million! (1,000,000)



Play Together

Numberling Line. What if you had a race to colour in the Numberblocks? Cut out the Numberblocks on the extra sheet and see who can colour theirs in first. Will you colour them in number order, from 1 to 3? Or backwards from 3 to 1? Or something else?

For your next mission, find the episode '100 Ways to Leave the Planet'

What if?

This mission belongs to _____

Meet the What Iffer!

What if... you drew all the way around him?

Print pages 1 and 2 double-sided and fold in half to make a booklet

That's a great question!

1

2

3

Level 5

Counting Systems

What if?

Match Up

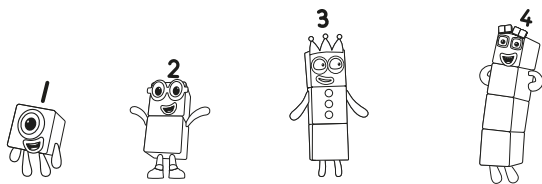

What if... you added a zero?

Draw lines to match each Numberblock to the Numberblock that is Ten times bigger.

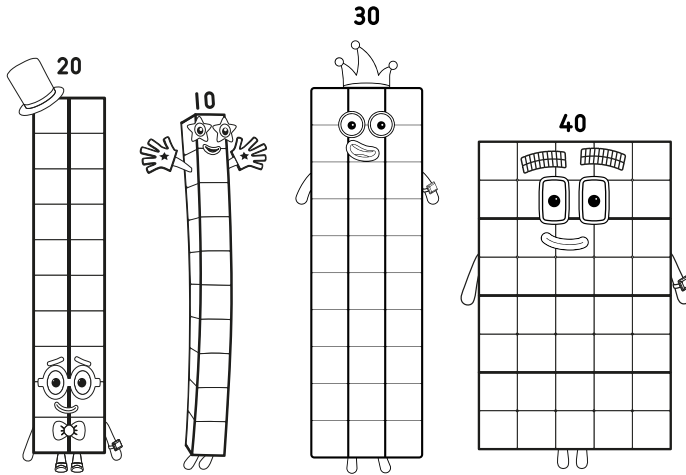

Adding More Zeroes

What if... you kept adding zeroes? Can you fill the gaps in the Numberlings so that they match each numberblock?

Adding 0 is the same as multiplying by 10!

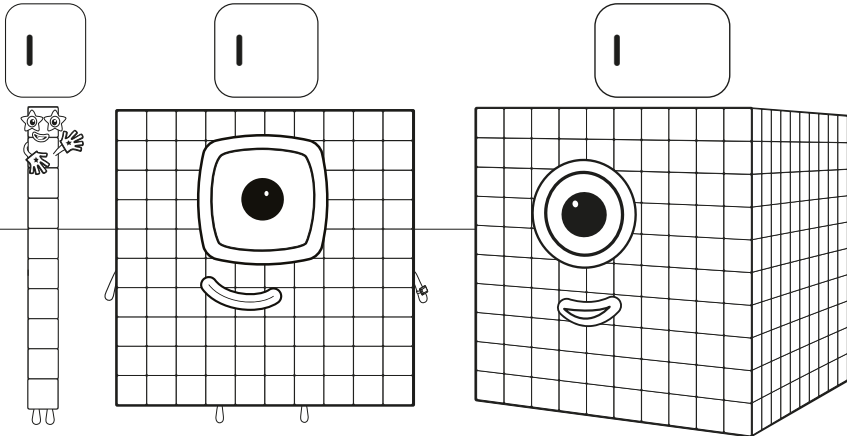

Less than Zero

What if... there could be a number less than zero?

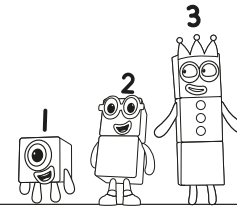
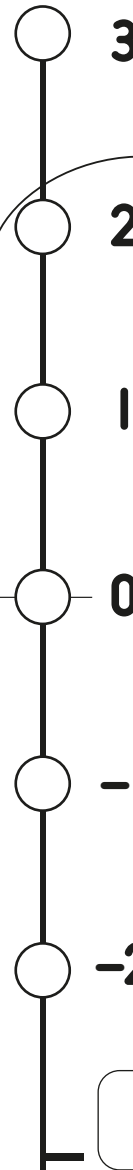

Can you fill in the blank space with the next number? Follow the pattern!



Split Up

What if... One could be divided into pieces?

Like slices of a cake!

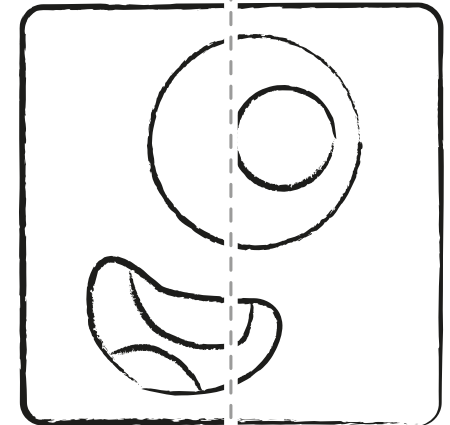
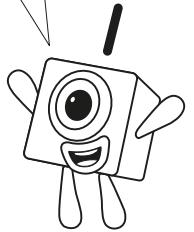

Can you draw a line to split the One cake in into 2 pieces? Can you split it into 4?



Numberling Line

