

Project		Location	
Contact		Date	
Part#		Fixture	

Focus 2" Lightbox

LED Lightbox For Expansive Surfaces



Description

The perfect option for backlighting dramatic, modern and beautiful graphic displays. Available at a length and width suitable for oversized displays, it delivers bright and even light with multiple options of Omnify's high quality light engines (OmniSheet™ and LumiCurtain™).

Applications

- Premium backlit graphics
- Commercial displays
- Large surfaces



5 YEAR WARRANTY



LM80



IP22



UL US LISTED



Manufactured in North America



Easy Installation



Integrated Quality Light Engine



Custom Dimensions



Frameless Design

Key Features

- 2" thick, with the option to customize dimensions for larger sizes, these lightboxes are perfect for dramatic displays
- Easy installation with z-bars
- Wide range of color temperature options available
- Easily swap graphics
- Each lightbox is powered by a patented, high-quality light engine, including: OmniSheet™ and LumiCurtain™
- A sleek and modern design with no frame for an elevated look

* Product shown with customer provided image printed on fabric diffuser

Specifications

Performance		Focus 2 inch
Part Number	#822212	
Light Engine	OmniSheet™ LumiCurtain™	
CRI	≥ 90 * ≥ 90 ** ≥ 85 **	
Color Temperature	2700K 3000K 3500K 4100K 5300K 6500K	
Surface Brightness*	~3,200 lx	
Lumen Maintenance	LM80	
Illumination	SFI (Single Face Illumination)	
Operating Temp.	-20° C (-4° F) ~ +50° C (+122° F)	
IP Rating	IP22	
Fire Rating	UL94V-0	
Environment	Dry location, Indoor use only	
UL / ETL	UL listed (E346146) UL sign (E334549)	
Warranty	5 Years	
Mechanical		
Frame Depth	2 5/64" (52.8 mm)	
Minimum Sizes	6" L x 6" W x 2 5/64" D 76 mm L x 76 mm W x 26.9875 mm D	
Maximum Sizes	480" L x 216" W x 2 5/64" D 12,192 mm L x 5,486 mm W x 26.9875 mm D	
Hanging Height	Max. 20' from floor	
Frame Materials	2 5/64" thick Anonized Aluminum Framing	
Frame Colors	Silver Custom color	
Diffuser Type	100% Polyester Fabric with Silicone Beading (Recommended 0.11" (2.8 mm) thick x 0.55" (14 mm) deep) Fabric Weight: 260 g/m² (± 3%) DIN EN ISO 9001:2015 Certified	
Mounting Options	Wall-mounted with z-bars Cable hanging set X 2 pcs (optional Euro Hanger, sold separately)	
Electrical		
Input Voltage	24V DC	
Power Consumption	2.4W /ft (Low Power), 4.4W /ft (Standard) * 6.0W /module ** 12W /sheet **	
Wire size	20 AWG 2 wire * 14 AWG Plenum bare wire ** 20 AWG wit 2 pin connectors **	
Wiring Options	Each panel must have direct connection to power supply. Do not wire them in series. Maximum wire length 20 ft (6 m) to avoid voltage drop	
Connector Options	Standard 5' (1500 mm) plenum wire Optional 10' (3000 mm) plenum wire with 2.1 / 5.5 mm DC Jack	

* Measurements done using 6mm omnisheet 2'x2' two side lit panel at 5300k

** LumiCurtain Light Engine

Customization

Customization Options

Shape & Size

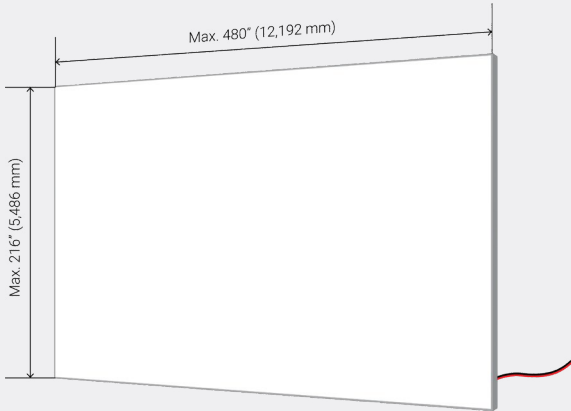

Custom Sizes

Custom sizes available (maximum 8' wide for UL compliance)

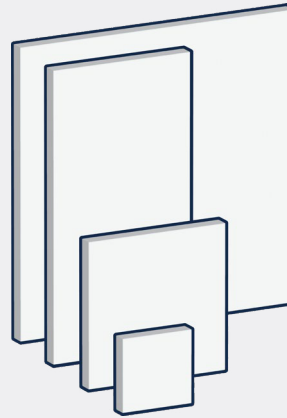

Custom Client Supplied Graphic

Most popularly ordered with a diffuser using standard White color high transmission fabric. Custom imagery fabric prints are also available at additional cost, artwork must be supplied by the client.

Supplied artwork must meet requirements posted in our downloadable **Print Submission Guidelines** ([click here](#)).

Profiles

2 5/64" Anodized Aluminum

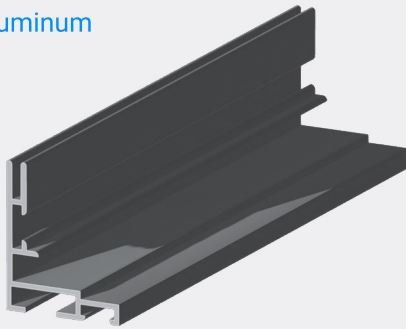
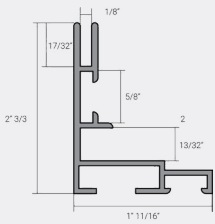

Customization

Wiring Options

Determine your system components, including a power adaptor, as well as optional dimmer and controller. Use only UL certified power adaptors with the power output that coordinates with your input voltage. Do not apply 24V DC to 12V DC panels, as within seconds the result may be burned LEDs or fire. Look for your voltage tags at the end of the power cord.

Using a Plug-in Power Adaptor

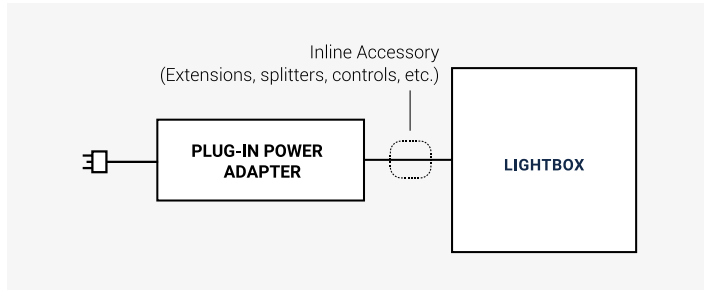

Use a plug-in adaptor to connect the Light Guided Panel to your power source via DC Jack.

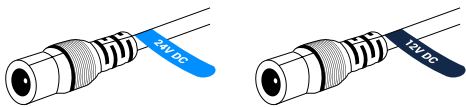

Wiring with Hardwire Power Adaptors

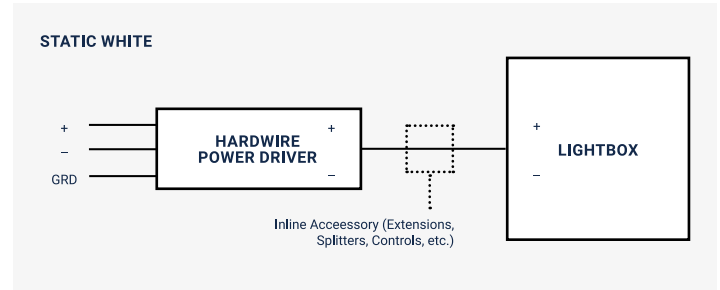

1. Turn off power to your system at the main breaker
2. Install your system componensts. Refer to wiring guidelines and approval drawings for each component.
3. Wire power adaptor to each assembly. Ensure the load does not exceed 80% of the maximum rated load of the power driver.
4. Check connections and turn on power at the main breaker.

Customization

Wire Exit Locations

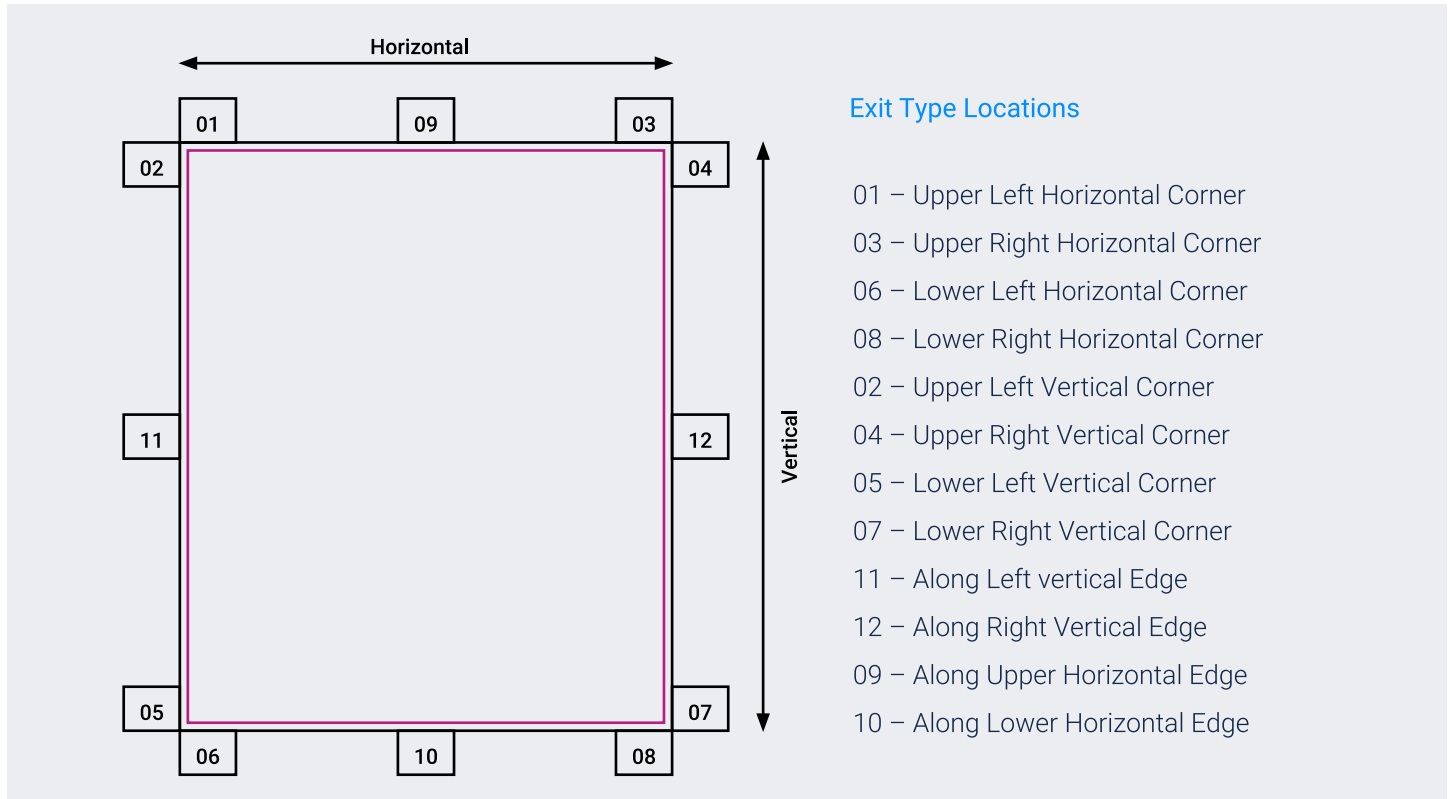

Mounting Options

Option 1: Z-Clips

1. Place the supplied Slat-Wall mounting hangers on frame back screw tighten securely
2. Make Drill Hole on wall for screw locations and make the screw holds
3. Place Slat-Wall mounting base on wall and screw thigh
4. Hold frame in position close to the wall and slide from top to bottom into the trace

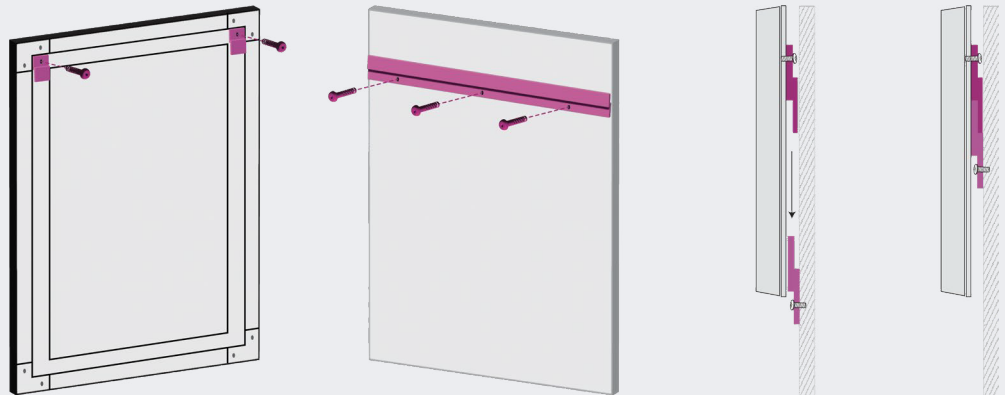

Option 2: Euro Hanger

Single-sided fixture is provided with four mounting clips with keyhole slot on back along with pre-drilled hole(s) for securing the frame to the wall.

You can relocate (Figure #1) or turn the mounting clip 180 degrees (Figure #2) by loosening the screw. Make sure the screw on the clip is tightened after relocation before you install the light box.

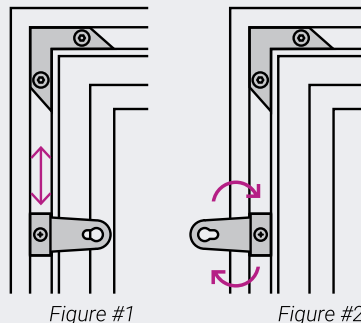

Configurator

Create your Focus 2" Lightbox

Base / Cover Part #	Frame Color	Light Engine	Dimensions (in)	Color Temperature
822212 – 2" Lightbox	10 – White	121614 – OmniSheet™ 6mm	Horizontal x Vertical	270 – 2700K
	20 – Silver	121814 – OmniSheet™ 8mm		300 – 3000K
	90 – Black	410400 – LumiCurtain™		410 – 4100K
	92 – Custom Color			530 – 5300K
				630 – 6300K

Voltage	Wattage (/ft, /module or /sheet)	Connectors	Mounting	
24 – 24V DC	2.4 – OmniSheet™ (2.4W/ft)	1 – Black 5' with barrel plug	1 – Z-Bars	
	4.4 – OmniSheet™ (4.4W/ft)	2 – White 5' with barrel plug	2 – Hanging cables	
	3.7 – LumiCurtain (6.0W/module)	3 – Black 10' with barrel plug		
		4 – White 10' with barrel plug		
		5 – Black 5' with bare leads		
		6 – White 5' with bare leads		
		7 – Black 10' with bare leads		
		8 – White 10' with bare leads		

822212-10-121614-24x36-300-24-4.4-2-2

Breakdown: Focus 2" Lightbox, White frame color, OmniSheet™ 6 mm light engine, 24" x 36" sized, 3000K Color temperature, 24V DC, 4.4W/ft, 5' white connector cable with DC Jack, mounted with Hanging Cables.