



**AGP<sup>®</sup>**

**2026  
TAIWAN  
PRODUCT  
CATALOG**



### **Our History**

In 1989, AGP started as a 2-person family company producing small power tools for the Taiwanese market. With years of dedication and the constant expansion to new markets, we have grown to be an international organization with over 180 skilled employees which is currently distributing products on 6 continents. AGP Taiwan serves as the design and manufacturing center for global markets. We export over 60% of our products to the European market. Since 2017, the sales and distribution of AGP products in the European market are organized by AGP Europe, located in Erpe Mere, Belgium.

### **Interesting Fact**

AGP comes from All Get Profit, as simple as it sounds, it symbolizes the values the founders of AGP keep, which are to be always mindful of all stakeholders within the entire business, including our suppliers and our customers.

### **BRAND VISION**

We Harness The Power of Technology, Enabling You to Achieve.

### **BRAND MISSION**

We Focus on Concrete Matters and Real Needs,  
Innovating Power Tools for The Toughest Demands.



### **R&D Capabilities**

With designers and engineers of unique backgrounds and a strategic R&D decision process, we transform new concepts into working power tools faster than most, providing advantages to our customers by greatly shortening the time frame to bring a new tool to market.

### **Consistent High Quality and Flexibility**

From in-house design and certified testing capabilities, to sourcing and production, we control each stage of the production process. This integration is key to maintaining consistent quality and maximum flexibility.

### **Responsive and Problem Solving**

Industry experience, creativity, and a dynamic team means we can be responsive to market needs. We listen to user suggestions to create products which are most suitable to their given market. We constantly seek out feedback from end users to find the best solutions to fit their needs.

### **Global Service**

AGP customers can receive their products quickly, safely and smoothly, thanks to the close collaboration with our distribution network in various countries. Find high quality power tools and receive any necessary service or repairs from our official distributors.



# Product Index

---

## Concrete Saws



Concrete Saws	C14, C16, HC16, HC18	
Ring Saws	R13, HR16	
Chainsaws	CS11, HCS19	
Converters	P9K	P.06 - P.29
Circular Saws	SCS7, SCS8	
Tile Saw	TS9	
Saw Track	AccuTrack for R13, C16, & C14	

---

## Core Drilling Motors



Tile Core Drills	TC20, TC40, TC402	
Dry Drilling Motors	DM51P, DM51D, DME51D, DME52D, DM62, DD62, DD160	
Wet+Dry Drilling Motors	DMC160, DM52D, DM52P, DMC6P, DMC6D, DDC5	
Wet Drilling Motors	DM2, DM5D, DM5P, DM6P, DM6D, DM8P	P.30 - P.67
Rig Mounted Motors	DDC9, DDC12, DM9, DM10, DM12, DM14, DM20	
Rigs	AS200, S170, NS250, S350, S500, S800, QS600	
Vacuum Pump	VP140	

---

## Concrete Grinders



Concrete Grinders	G5, G7, G125, G180, BG125, BG5	
Converters	P4K	P.69 - P.81
Long-Reach Concrete Grinder	LG125	

---

## Wall Chasers



Wall Chasers	CG125, CG150, CS125N, CS180	P.82 - P.86
--------------	-----------------------------	-------------

---

## Drywall Sanders



Drywall Sanders	HS225, SB9, GS9FE, GS9FSE,	P.87 - P.91
-----------------	----------------------------	-------------

---

## Concrete Vibrators



Concrete Vibrators	H43, VR600, VRN1400	P.92 - P.94
--------------------	---------------------	-------------

---

## Mixers



Mixers	EV32, EV42, EV52, EV160, EV10ELM, EVP180, EV21	P.95 - P.97
--------	--	-------------

---

## Vacuums



Vacuums	DE25, DEP25	P.98 - P.99
---------	-------------	-------------

---

## Magnetic Core Drills



Auto-Reverse Tapping Magnetic Core Drill	TP2000	
Low Profile Magnetic Core Drill	PMD3530	
Semi Auto Feed Magnetic Core Drill	MD300N	
1-Speed Magnetic Core Drills	SMD351L, SMD351H	P.100 - P.123
2-Speed Magnetic Core Drills	SMD352, SMD502, MD500/2, ST50	
4-Speed Magnetic Core Drills	MD750/4, MDS750/4, MD120/4	



## Metal Saws

Metal Saws	CS200, CS230N, CS320, DRC355	P.124 - P.128
------------	------------------------------	---------------



## Tapper

Tapper	T14	P.129
--------	-----	-------



## Electric Bevelers

Electric Bevelers	EB6T, EB12, EB24R	P.130 - P.132
-------------------	-------------------	---------------



## Straight Grinder

Straight Grinder	SG6	P.134
------------------	-----	-------



## Metal Sander/ Polishers

Metal Sander/ Polishers	WS760, DP100	P.135- P.137
-------------------------	--------------	--------------



## Plumbing/HVAC

Digital Bending Machine	DB32	
Hole Cutting Drill	HC127	P.138 - P.142
Reciprocating Saw	RS26, RS130B	



## Woodworking Tools

Plunge Cut Circular Saw	DS1600	P.143
-------------------------	--------	-------



## Paint Sprayers

High Pressure Disinfectant Sprayer	HA10	
Electric Piston Pump Airless Sprayers	EC021, PM021LF, PM025LF, PM021, PM025, PM031, PM039	P.144 - P.155
Engine Airless Paint Sprayer	PE048	
HVLP Turbine Paint Sprayer	T328	

### Key to symbols used this catalog:

Overload Protection	Soft Start	Double Insulation (Class II)	2 3 4 Number of Gears
Variable Speed	Forward & Reverse	Constant Speed	Plastic Carry Case
			Blow Molded Case

# DIAMOND CONCRETE SAWS

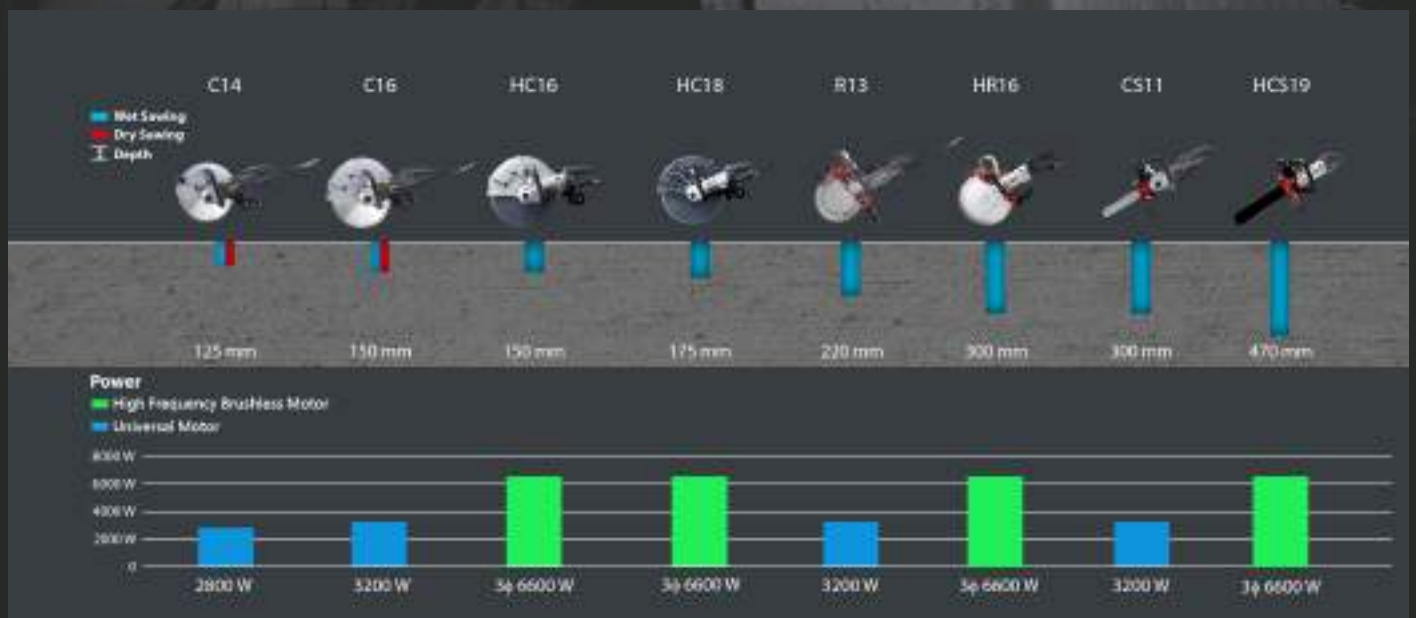



# C14 CONCRETE SAW

355 mm (14") handheld wet or dry diamond saw with 3000 W motor for up to 125 mm depth of cut. Ideal for indoor cutting.



■ **Dry Cutting With Dust Skid (Optional)**

With spring-loaded suspension for ideal dust containment when dry cutting



Model	C14
Power Input	3000 W (230-240 V), 2800 W (220 V), 2300 W (110-120 V)
Voltage, Frequency	230-240 V~ 50-60 Hz, 220 V~ 50-60 Hz or 110-120 V~ 50-60 Hz
No Load Speed	4500 min <sup>-1</sup>
Blade Diameter	355 mm (14")
Arbor	25.4 mm (1")
Max. Cutting Depth	125 mm (5")
Soft Start & Overload Protection	With
Insulation Class	Class I with PRCD / GFCI
Dimensions (LxWxH)	611 x 245 x 280 mm
Weight	7.9 kg (17 lb) 8.3 kg (18 lb) with guide rollers
Characteristics / Certification	

**Features**

1. LED Indicator Indicates load conditions (electronic & thermal protection).
2. Integrated water feed system with fine adjustable flow and quick release coupling.
3. Tool-free detachable guide rollers for perpendicular cuts and reduced operator fatigue.
4. Tool-free detachable splash guard.
5. Tool-free blade guard angle adjustment. Handles designed for optimal control.
6. The dust and water resistant solid-state switch is more durable and reliable than traditional switches.
7. Quick removable brush for slurry.
8. Externally accessible brushes.

**Standard/ Optional Accessories See p. 24**

# C16 CONCRETE SAW

406 mm (16") handheld wet or dry diamond saw with 3200 W motor for up to 150 mm depth of cut. Ideal for indoor cutting.



■ **Dry Cutting With Dust Skid (Optional)**

With spring-loaded suspension for ideal dust containment when dry cutting



■ **Flush Cutting (Optional)**

Flush cutting details see p. 12



Model	C16
Power Input	3200 W (230-240 V), 3000 W (220 V), 2800 W (110-120 V)
Voltage, Frequency	230-240 V~ 50-60 Hz, 220 V~ 50-60 Hz or 110-120 V~ 50-60 Hz
No Load Speed	3900 min <sup>-1</sup>
Blade Diameter	406 mm (16")
Arbor	25.4 mm (1")
Max. Cutting Depth	150 mm (6")
Soft Start & Overload Protection	With
Insulation Class	Class I, (220-240 V models with PRCD / GFCI)
Dimensions (LxWxH)	660 x 259 x 280 mm
Weight	9.6 kg (21.1 lb) 10 kg (22.2 lb) with guide rollers
Characteristics / Certification	

**Features**

1. LED Indicator Indicates load conditions (electronic & thermal protection).
2. Integrated water feed system with fine adjustable flow and quick release coupling.
3. Tool-free detachable guide rollers for perpendicular cuts and reduced operator fatigue.
4. Tool-free detachable splash guard.
5. Tool-free blade guard angle adjustment. Handles designed for optimal control.
6. Vacuum port for dust or slurry collection with cap.
7. Quick removable brush for slurry.
8. Externally accessible brushes.
9. The dust and water resistant solid-state switch is more durable and reliable than traditional switches.

**Standard/ Optional Accessories See p. 24**

# HC16 HIGH FREQUENCY CONCRETE SAW

406 mm (16") concrete saw with 6600 W high frequency permanent magnet synchronous motor for up to 150 mm depth of cut. Flush cut capability.



This saw requires the P9K power converter to operate

■ **P9K**



P9K details see p. 22

■ **Flush Cutting**



Flush cutting details see p. 12

**Features**

1. LED Indicator Indicates load conditions (electronic & thermal protection).
2. Constant speed is maintained regardless of load.
3. Integrated water feed system with fine adjustable flow and quick release coupling.
4. Tool-free detachable guide rollers for perpendicular cuts and reduced operator fatigue.
5. Tool-free detachable splash guard.
6. Tool-free blade guard angle adjustment.
7. The dust and water resistant solid-state switch is more durable and reliable than traditional switches.
8. Handles designed for optimal control.
9. Quick removable brush for slurry.

Model	HC16	
Power Input	3φ~ 380-480 V	6600 W
	1φ~ 220-240 V	3350 W
No Load Speed**	4700 min <sup>-1</sup>	
Blade Diameter	406 mm (16")	
Arbor	25.4 mm (1")	
Max. Cutting Depth	150 mm (6")	
Ingress Protection Rating	IP66	
Soft Start & Overload Protection	With	
Cable Length	6 m	
Dimensions (LxWxH)	665 x 258 x 430 mm	
Weight	10.6 kg (23.1 lb)	
Characteristics / Certification		

\*\* Due to the motor design, the no load and the rated load speeds are roughly the same.

**Standard/ Optional Accessories See p. 24**

# HC18 HIGH FREQUENCY CONCRETE SAW

457 mm (18") wet concrete saw with 6600 W high frequency permanent magnet synchronous motor for up to 175 mm depth of cut. With flush cut capability.



## ■ Flush Cutting



Flush cutting details see p. 12

Model	HC18	
Power Input	3φ~ 380-480 V	6600 W
	1φ~ 220-240 V	3350 W
No Load Speed**	3000 min <sup>-1</sup>	
Blade Diameter	457 mm (18")	
Arbor	25.4 mm (1")	
Max. Cutting Depth	175 mm (6")	
Ingress Protection Rating	IP66	
Soft Start & Overload Protection	With	
Cable Length	6 m	
Dimensions (LxWxH)	699 x 268 x 491 mm	
Weight	11.6 kg (25.5 lb)	
Characteristics / Certification		

\*\* Due to the motor design, the no load and the rated load speeds are roughly the same.

This saw requires the P9K power converter to operate

## ■ P9K



P9K details see p. 22

## Features

1. LED Indicator Indicates load conditions (electronic & thermal protection).
2. Constant speed is maintained regardless of load.
3. Integrated water feed system with fine adjustable flow and quick release coupling.
4. Tool-free detachable guide rollers for perpendicular cuts and reduced operator fatigue.
5. Tool-free detachable splash guard.
6. Tool-free blade guard angle adjustment.
7. The dust and water resistant solid-state switch is more durable and reliable than traditional switches.
8. Handles designed for optimal control.

**Standard/ Optional Accessories See p. 24**

▪ **Flush Cutting (Optional on C16, HC16, HC18)**

To perform flush cutting, one must first mount a Flush Cutting Flange Kit (choose A or B), a suitable flush cutting blade, and install the Flush Cut Cover Set. Each kit comes complete with all necessary fasteners.



C16, HC16



HC18

**Flush Cutting Flange Kits**



**A. HY Pattern Flush Cutting Kit- 1" arbor 6-bolt (60 mm bolt hole circle)**



**B. HV Pattern Flush Cutting Kit- 1" arbor Longyear 6-bolt (3-1/2" (88.9 mm) bolt hole circle) & 3-bolt combined**



**Flush Cutting Blade**

88.9 mm bolt hole circle (for use with the B. HV Pattern Flush Cutting Kit above)



**Flush Cut Cover Set**

For enhanced safety when flush cutting

▪ **Dry Cutting With Dust Skid (Optional on C14, C16)**

With spring-loaded suspension for ideal dust containment when dry cutting.



(14" for C14)



(16" for C16)

▪ **High Frequency Brushless Motor (On HC16, HC18)**



P9K Power Converter

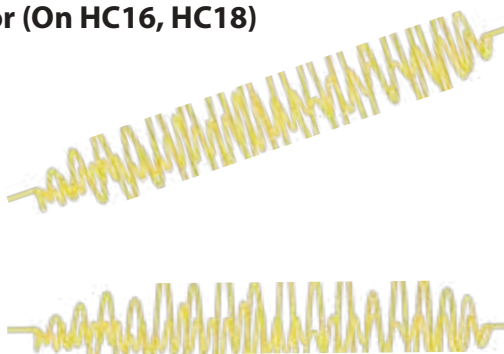

HC18



HC16

# Features



## Toggle Latches

Blade Guard with Toggle Latches for quick conversion to Flush cutting



## LED Indicator

LED Indicator Indicates load conditions (electronic & thermal protection).



## Blade Guard

Tool-free blade guard angle adjustment. Handles designed for optimal control.



## Guide Rollers

Tool-free detachable guide rollers for perpendicular cuts and reduced operator fatigue.



## Splash Guard

Tool-free detachable splash guard.



## Vacuum Port

Vacuum port for dust or slurry collection with cap.



# R13 RING SAW

330 mm (13") wet ring saw with 3200 W universal motor for up to 220 mm depth of cut.



Model	R13
Power Input	3200 W (230-240 V), 3000 W (220 V), 2800 W (110-120 V)
Voltage, Frequency	230-240 V~ 50-60 Hz, 220 V~ 50-60 Hz or 110-120 V~ 50-60 Hz
No Load Speed	3900 min <sup>-1</sup>
Blade Diameter	330 mm (13")
Max. Cutting Depth	220 mm (8.7")
Soft Start & Overload Protection	With
Insulation Class	Class I, (220-240 V models with PRCD / GFCI)
Dimensions (LxWxH)	730 x 280 x 450 mm
Weight	12.4 kg (27.3 lb)(Not incl. blade)
Characteristics / Certification	

## Features

1. Patented One Step Drive Tensioner makes fast and easy blade adjustment and keeps tension equalized.
2. Change saw blade quickly and without disassembly of the cover.
3. High Stability Guide Roller design keeps the blade stable and centralized when beginning the cut.
4. LED Indicator Indicates load conditions (electronic & thermal protection).
5. Flexible upper and bottom splash guards prevent splashing slurry.
6. The dust and water resistant solid-state switch is more durable and reliable than traditional switches.
7. Water feed system with fine adjustable flow and quick release coupling.
8. Externally accessible brushes.

**Standard/ Optional Accessories See p. 25**

# HR16 HIGH FREQUENCY RING SAW

400 mm wet ring saw with 6600 W high frequency permanent magnet synchronous motor for up to 300 mm depth of cut.



This saw requires the P9K power converter to operate



P9K details see p. 22

## Features

1. Patented One Step Drive Tensioner makes fast and easy blade adjustment and keeps tension equalized.
2. Change saw blade quickly and without disassembly of the cover.
3. High Stability Guide Roller design keeps the blade stable and centralized when beginning the cut.
4. LED Indicator Indicates load conditions (electronic & thermal protection).
5. Flexible upper and bottom splash guards prevent splashing slurry.
6. The dust and water resistant solid-state switch is more durable and reliable than traditional switches.
7. Water feed system with fine adjustable flow and quick release coupling.

**Standard/ Optional Accessories See p. 24**

Model	HR16	
Power Input	3φ~ 380-480 V	6600 W
	1φ~ 220-240 V	3350 W
No Load Speed**	2500 min <sup>-1</sup>	
Blade Diameter	400 mm (15-3/4")	
Max. Cutting Depth	300 mm (11-13/16")	
Soft Start & Overload Protection	With	
Ingress Protection Rating	IP66	
Cable Length	6 m	
Dimensions (LxWxH)	780 x 290 x 500 mm	
Weight	13.2 kg (29.1 lb)	
Characteristics / Certification		

\*\* Due to the motor design, the no load and the rated load speeds are roughly the same.

# Unparalleled Cutting Depth For A Hand-Held Saw

## R13 – 220 mm Cut

With a standard wall saw, you'd need a circular blade diameter of at least 540 mm to match the R13's cutting depth.

330 mm Ring Saw

540 mm Wall Saw

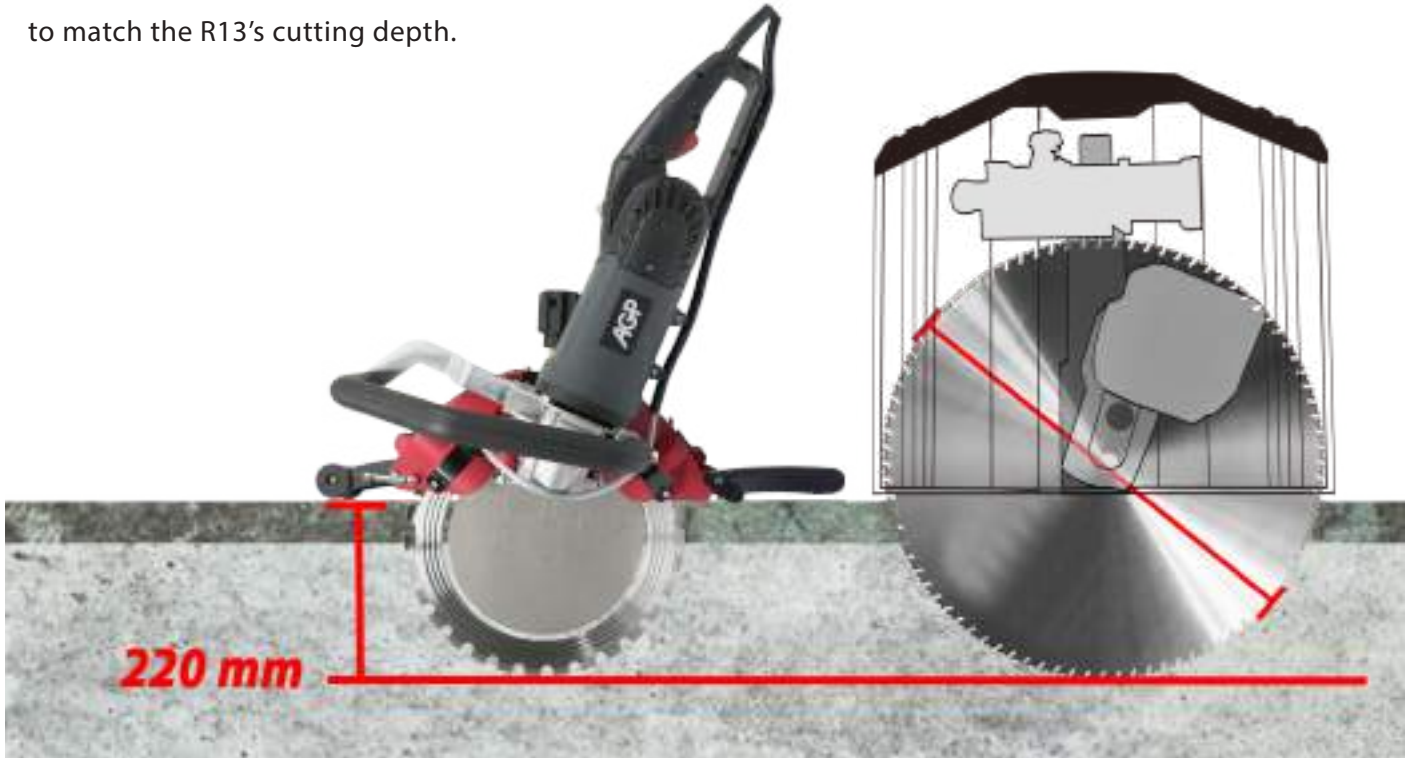

## HR16 – 300 mm Cut

With a standard wall saw, you'd need a circular blade diameter of at least 700 mm to match the HR16's cutting depth.

405 mm Ring Saw

700 mm Wall Saw

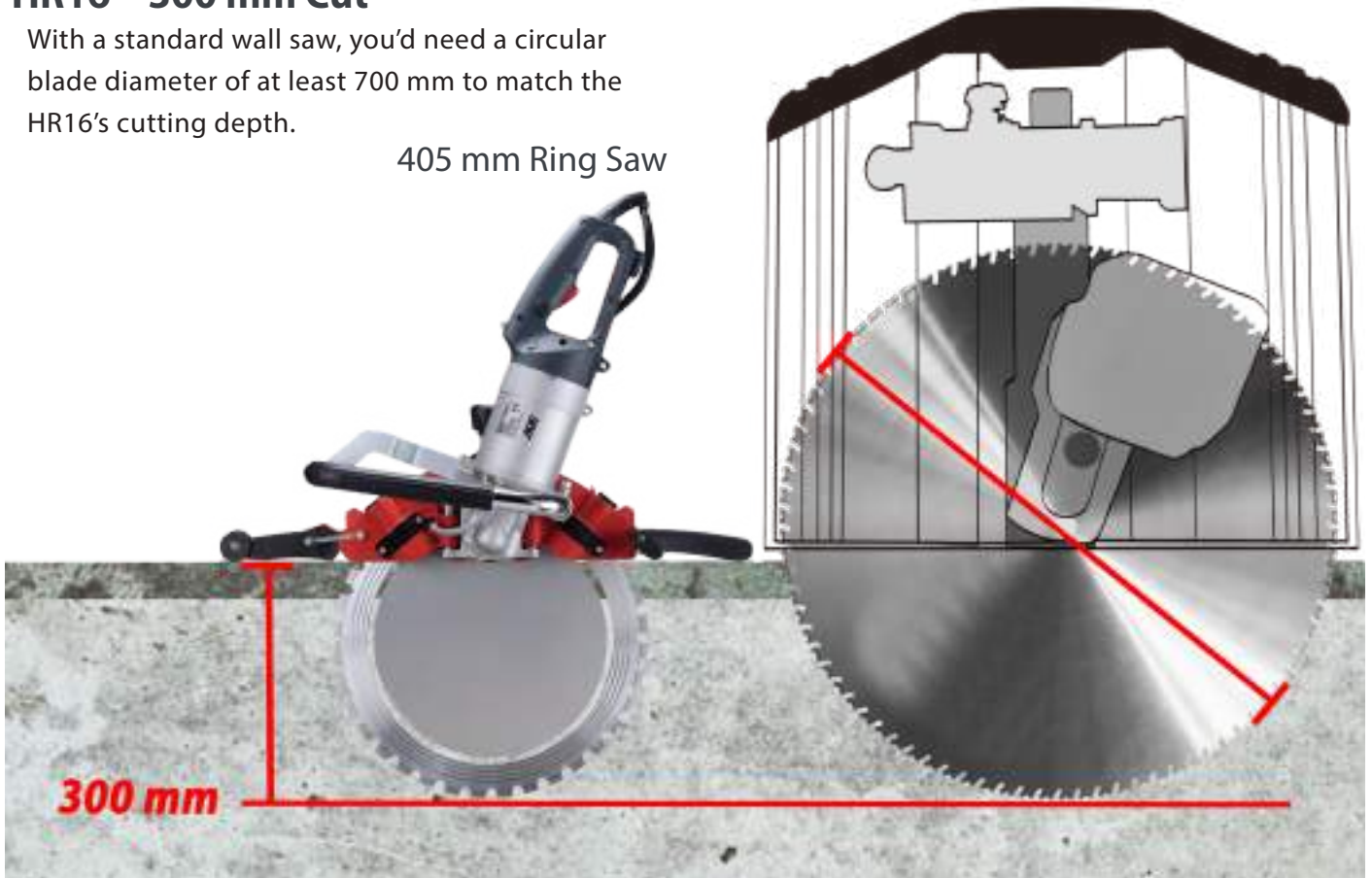

# Features



**Simple Side-Thrust Tuning**  
Maximum-stability guide roller design keeps the blade centralized.



**One-Step Blade Tensioning System**  
Patented One- Step Drive Tensioner makes fast and easy blade adjustment and keeps tension equalized.



**LED Load Indicator**  
LED Indicator Indicates load conditions (electronic & thermal protection).



**Splash Guards**  
Flexible upper and bottom splash guards prevent splashing slurry.



**Ergonomic Handle Design**  
Optimum control and minimized fatigue.

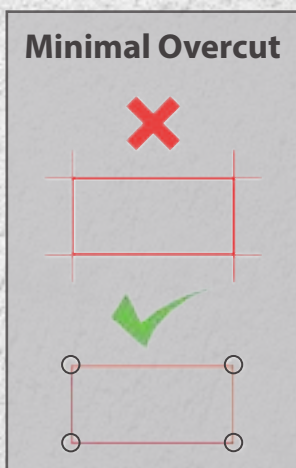

**RingSaw  
Action Video**



**Quick & Easy Blade Changing**  
No need to strip the drive cover to change the blade.

# CS11 CONCRETE CHAINSAW

Concrete chain saw with single phase 3200 W motor and up to 300 mm plunge cutting depth. Excellent for precise corner cut outs with no overcuts.



Model	CS11
Power Input	220 V: 2800 W (certificate), 3200 W (actual) 110 V: 2600 W (certificate), 3000 W (actual)
Voltage, Frequency	220-240 V~ 50-60 Hz or 110-120 V~ 50-60 Hz
No Load Speed	10,000 min <sup>-1</sup>
Guide Bar Nominal Length	330 mm (13")
Diamond Chain	25 link
Max. Cutting Depth	300 mm (11.8")
Soft Start & Overload Protection	With
Insulation Class	Class I, (220-240 V models with PRCD / GFCI)
Dimensions (LxWxH)	630 mm (930 mm with guide bar) x 215 mm x 280 mm
Weight	8.0 kg (17.6 lb), 8.94 kg (19.7 lb) with guide bar & chain
Characteristics / Certification	

## Features

1. LED Indicator Indicates load conditions (electronic & thermal protection).
2. Bumper Spike for increased leverage.
3. Flexible Splash Flap helps contain slurry.
4. Dual plane horizontal and vertical spirit levels for precise alignment.
5. Wide base for setting tool down and adjusting.
6. The dust and water resistant solid-state switch is more durable and reliable than traditional switches.

**Standard/ Optional Accessories See p. 25**

# HCS19 HIGH FREQUENCY BRUSHLESS CHAINSAW

Concrete chainsaw with 6600 W high frequency permanent magnet synchronous motor. Excellent for deep plunge cuts and precise corner cut outs with no overcuts.



This saw requires the P9K power converter to operate

■ P9K



P9K details see p. 22



7

Model	HCS19	
Power Input	3φ~ 380-480 V	6600 W
	1φ~ 220-240 V	3350 W
No Load Speed**	8500 min <sup>-1</sup>	
Guide Bar Nominal Length	12" , 14" , 16" or 18"	
Max. Cutting Depth	470 mm (w / 18" Bar)	
Soft Start & Overload Protection	With	
Ingress Protection Rating	IP66	
Dimensions (LxWxH)	569 x 218 x 312mm	
Weight	8.7 kg (19.1 lb)	
Characteristics / Certification		

## Features

1. Constant speed is maintained regardless of load.
2. LED Indicator Indicates load conditions (electronic & thermal protection).
3. Bumper Spike for increased leverage.
4. Flexible Splash Flap helps contain slurry.
5. Dual plane horizontal and vertical spirit levels for precise alignment.
6. Wide base for setting tool down and adjusting.
7. Design allows cutting close to the wall.
8. Tool-free bar clamp lever for faster chain tension adjustment.
9. Special motor coupling cable.
10. The dust and water resistant solid-state switch is more durable and reliable than traditional switches.

**Standard/ Optional Accessories See p. 25**

\*\* Due to the motor design, the no load and the rated load speeds are roughly the same.

# Features

## 6600 W Permanent Magnet Synchronous Motor: A Revolution In Brushless Motors

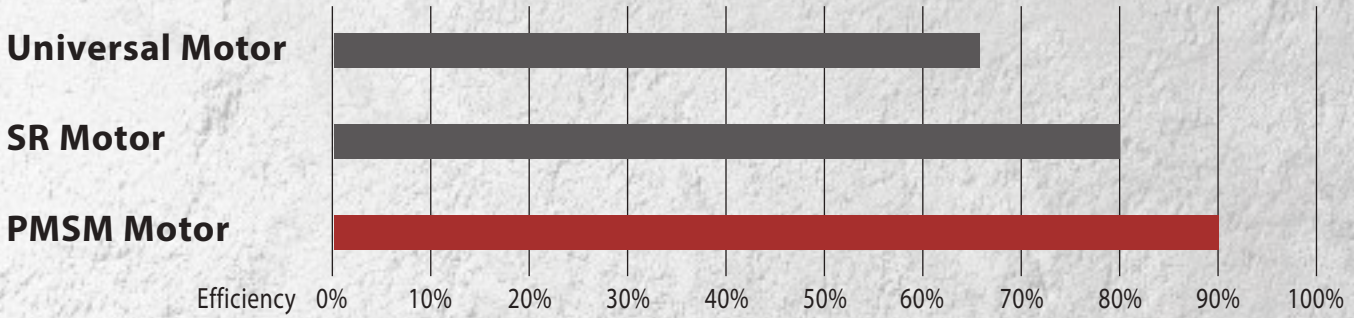

### Higher Reliability

No carbon brush changes and longer life time.

### Higher Productivity

More efficient PMSM motor for faster results and less wasted energy.

### More Power

Higher raw power output for challenging cuts

### Slurry Resistant

Uniquely designed to prevent ingress of water, dust, and slurry.

### Faster Chain Adjustment

The tool-free bar clamp lever allows chain adjustments with no need for additional tools.

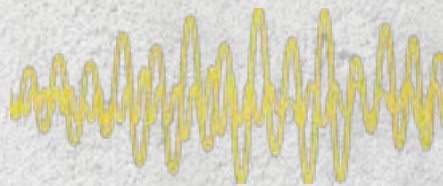

**Bumper Spike**  
Bumper Spike for increased leverage



**LED Indicator**  
LED Indicator  
Indicates load conditions



**Spirit Levels**  
Dual plane horizontal and vertical spirit levels for precise alignment



**Splash Flap**  
Flexible Splash Flap helps contain slurry



**Flush Cutting**  
Special design allows very close to flush cutting



**Bar Clamp Lever**  
Tool-free bar clamp lever for faster chain tension adjustment

# P9K POWER CONVERTER

Water cooled 9000 W power converter for driving our high frequency tools.

1. Built-in PRCD has full electronic protection for over and under voltage, thermal and current overload supplies high frequency current to the tool.
2. LCD Information Display shows voltage, elapsed hours, error codes, etc.
3. Recognizes the connected tool.



Model	P9K
Power Input (maximum)	3φ~ 380-480 V : 16 A 9000 W 1φ~ 220-240 V : 16 A 3600 W
Min. Water Flow (25°C)	3.5 L/min (1 gpm)
Max. Water Pressure	7 bar (100 psi)
Ingress Protection Rating	IP66
Dimensions (LxWxH)	442 x 219 x 251 mm
Weight	6.0 kg (13.2 lb)



**Application: HC16, HC18, HR16, HCS19**



# ACCUTRACK SYSTEM For R13, C16, and C14 Saws

An accurate, easy, and safe saw track system for perfectly precise cuts giving wall saw functionality in a versatile package. The same cutting line is shared, allowing precuts with the hand saw and final cuts with the ring saw.

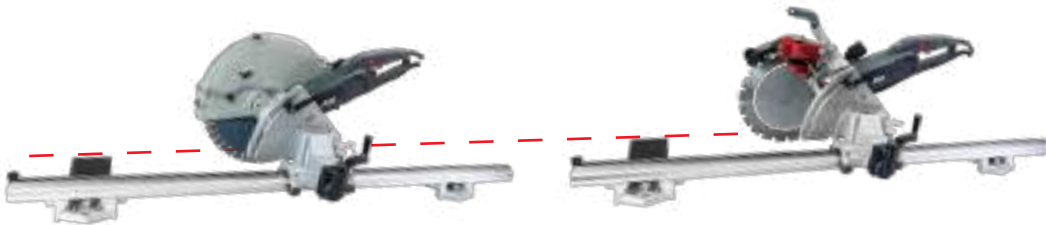

## Features

1. Traversing crank for controlled, low-fatigue operation.
2. Tool-free, precise depth control.
3. Rigid construction and precise guidance for accurate results.
4. Modular system allows easy extension.

Cutting Depth	R13-219 mm
	C16-147 mm
	C14-122 mm
Anchor to Cutting Line	220 mm
Weight	11.6 kg (25.6 lb) 1.5 m
	16.3 kg (35.9 lb) 1.5 m+1.0 m

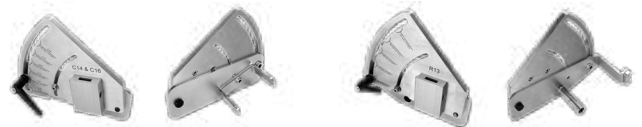

C14/C16 Cradle Adapter

R13 Cradle Adapter

\*Saws sold separately

# Sawing Accessories

## C14 Concrete Saw

Standard Accessories	
M17 Combination Wrench	
Guide Roller Set	
Splash Guard Unit	
Blade Guard Brush	
PRCD / GFCI Interruptor	
Optional Accessories	Part Number
355 mm (14") Diamond Blade	305-00036-000-062
<b>a</b> Dust Skid 14"	0299-0212-0004-002
Accutrack System	See p. 23



**a** Dust Skid (C14)



**b** Dust Skid (C16)

## C16 Concrete Saw

Standard Accessories	
M17 Combination Wrench	
M3 L-hex wrench	
PRCD / GFCI Interruptor (220V models only)	
Optional Accessories	Part Number
<b>b</b> Dust Skid 16"	0299-0212-0004-007
<b>c1</b> Flush Cutting Flange Kit (60 mm)	0299-0213-0000-002
<b>c2</b> Flush Cutting Flange Kit (88.9 mm)	0299-0213-0000-001
<b>d</b> 406 mm (16") Flush Cutting Blade (88.9 mm)	305-00036-000-067
<b>e</b> Flush Cut Cover Set	0299-0284-00000-001
Accutrack System	See p. 23



**c1** Flush Cutting Flange Kit (60 mm)



**c2** Flush Cutting Flange Kit (88.9 mm)

## HC16 High Frequency Concrete Saw

Standard Accessories	
Hex Key (M3)	
Wrench (M17)	
<b>c</b> Flush Cutting Flange Kit (choose 60 mm or 88.9 mm)	
<b>e</b> Flush Cut Cover Set	
Plastic Carry Case	
Optional Accessories	Part Number
<b>d</b> 406 mm (16") Flush Cutting Blade (88.9 mm)	305-00036-000-067



**d** Flush Cutting Blade



**e** Flush Cut Cover Set

## HC18 High Frequency Concrete Saw

Standard Accessories	
<b>c</b> Flush Cutting Flange Kits (60 mm or 88.9 mm)	
Flush Cutting Rim Brush	
Plastic Carry Case	
Optional Accessories	Part Number
<b>d</b> 457 mm (18") Flush Cutting Blade (88.9 mm)	305-00036-000-077

# Sawing Accessories

## R13 Ring Saw

Standard Accessories	Part Number
T-Wrench	
Face Spanner	
Plastic Carry Case	
<b>f</b> 330 mm Ring Saw Blade	305-00036-000-072
PRCD / GFCI Interruptor (220V models only)	
Accutrack System	See p. 23



**f** Ring Saw Blade

## HR16 High Frequency Ring Saw

Standard Accessories	Part Number
T-Wrench	
Plastic Carry Case	
Face Spanner	
<b>f</b> 400 mm Ring Saw Blade	305-00036-000-071



**g** Guide Bar

## CS11 Concrete Chainsaw

Standard Accessories
T-Wrench
PRCD / GFCI Interruptor (220 V models only)
Optional Accessories
<b>g</b> Guide Bar (13")
<b>h</b> Diamond Chain (general purpose) (25 link)
<b>i</b> Sprocket 3/8"
Carry Bag

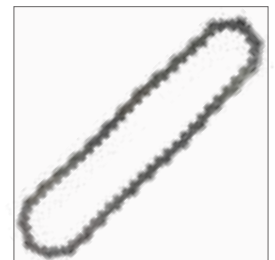

**h** Diamond Chain

## HCS19 High Frequency Concrete Chainsaw

Standard Accessories
Snap Ring Pliers
T-Wrench
Hex Key (M4)
Optional Accessories
<b>g</b> Guide Bar (12, 14, 16, or 18")
<b>h</b> Diamond Chain (general purpose)
<b>i</b> Sprocket 0.444"



**i** Sprocket

# SCS7 STONE CUTTING CIRCULAR SAW

A 180 mm wet stone saw with 55 mm depth of cut and 1800 W motor. Use the optional guide rail for precise control.



## Features

1. Depth Scale for control of cut.
2. Parallel Guide for straight cuts.
3. Sighting Notch for accurate cutting.
4. Optional Guide Rail for precise control of the cutting process.

**Standard/ Optional Accessories See p. 29**

Model	SCS7
Power Input	1800 W (220 V), 1680 W (110 V)
Voltage, Frequency	220-240 V~ 50-60 Hz or 110-120 V~ 50-60 Hz
No Load Speed	5800 min <sup>-1</sup>
Arbor	22.23 mm (7/8")
Max. Blade Diameter	180 mm
Max. Cutting Depth	55 mm
Overload Protection	With
Soft Start	With
Insulation Class	Class I with PRCD / GFCI
Dimensions (LxWxH)	350 x 270 x 265 mm
Weight	6.7 kg (14.7 lb)
Characteristics / Certification	

# SCS8 STONE CUTTING CIRCULAR SAW

A 200 mm stone saw with 70 mm depth of cut and 2200 W constant speed motor. Use the optional guide rail for precise control for precise control.



Model	SCS8
Power Input	2200 W (220 V), 1680 W (110 V)
Voltage, Frequency	220-240 V~ 50-60 Hz or 110-120 V~ 50-60 Hz
No Load Speed	6000 min <sup>-1</sup>
Arbor	22.23 mm (7/8")
Blade Diameter	200 mm (8") or 180 mm (7")
Cutting Depth (0°)	70 mm (65 mm on rail) 200 mm blade 60 mm (55 mm on rail) 180 mm blade
Cutting Depth (45°)	52 mm (47 mm on rail) 200 mm blade 45 mm (40 mm on rail) 180 mm blade
Cutting Width Range (w/ parallel guide)	10 - 130 mm
Overload Protection	With
Insulation Class	Class I with PRCD / GFCI
Dimensions (LxWxH)	484 x 313 x 198 mm
Weight	5.7 kg (12.5 lb)
Characteristics / Certification	

## Features

1. LED Load Indicator & Constant Speed Motor for maximum work efficiency.
2. Suitable for both wet and dry cutting.
3. On-board wrench storage.
4. Bevel Cutting Capability.
5. The dust and water resistant solid-state switch is more durable and reliable than traditional switches.
6. Depth Scale for control of cut.
7. Sighting Notches (0°, 30° & 45°) for accurate cutting.
8. Parallel Guide for straight cuts.
9. Optional Guide Rail for precise control of the cutting process.

**Standard/ Optional Accessories See p. 29**

# TS9 WET TILE SAW

A 230 mm professional grade, high precision wet tile saw with unique water recirculation design. 48 mm depth of cut. 45° bevel cut capability.



Quick-release table mountings.

Model	TS9
Motor Type	Single Phase AC Induction
Power Output	0.8 kW (1.1 HP)
Voltage, Frequency	220-240 V~ 50-60 Hz or 110-120 V~ 50-60 Hz
No Load Speed	3000 min <sup>-1</sup> (50 Hz), 3600 min <sup>-1</sup> (60 Hz)
Max. Blade Diameter	230 mm (9")
Blade Bore	25.4 mm (1")
Bevel Capability	0-45°
Max. Cutting Depth-straight	48 mm (1-7/8")
Max. Cutting Depth- at 45°	37 mm (1-7/16")
Rip Cut - Left	305 mm (12")
Rip Cut - Left at 45° Bevel	295 mm (11-39/64")
Rip Cut - Right	147 mm (5-25/32")
Diagonal (Miter) Cut - Left	285 mm (11-7/32")
Diagonal Cut - Left at 45° Bevel	275 mm (10-13/16")
Front of Blade to Table Edge	200 mm (7-7/8")
Ingress Protection	IP44
Dimensions (LxWxH)	660 x 595 x 320 mm
Weight	14.7 kg (32.4 lb)
Characteristics / Certification	<b>CE CB</b>



Easy mounting  
1.5 L water tray



Angle Guide Plate &  
Micro-adjustable cutting guide

## Features

1. Easy Miter adjustment miters up to 45 degrees.
2. Easy mounting 1.5 L water tray.
3. Quick-release table mountings. Quick tool-free removal of the table for easy cleaning and blade replacement.
4. Rugged, stable, and easy-to-clean table with cutting scale.
5. Micro-adjustable cutting guide always remains parallel.
6. Angle Guide Plate holds work pieces at various angles.

## Standard Accessories

- Diamond Blade
- Parallel Cutting Guide
- Angle Guide Plate
- M8 Combination Wrench
- M19 Combination Wrench

# Sawing Accessories

## SCS7 Stone Cutting Circular Saw

Standard Accessories	
Parallel Guide	
Quick-release Water Hose Coupling	
M6 L-Hex Wrench	
PRCD / GFCI Interruptor	
Plastic Carry Case	
Optional Accessories	
7" Diamond Blade	
<b>a</b> Aluminum Guide Rails (1400 mm & 800 mm available)	
<b>b</b> Guide Rail Connector	
<b>c</b> Lever Clamp	

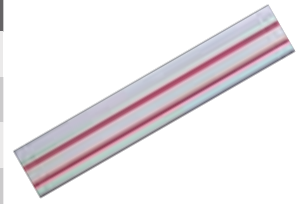

**a** Aluminum Guide Rails



**b** Guide Rail Connector



**c** Lever Clamp

## SCS8 Stone Cutting Circular Saw

Standard Accessories	
Parallel Guide	
Quick-release Water Hose Coupling	
M6 L-Hex Wrench	
PRCD / GFCI Interruptor	
Plastic Carry Case	
Optional Accessories	
180 mm (7") or 200 mm (8") Diamond Blade	
<b>a</b> Aluminum Guide Rails (1400 mm & 800 mm available)	
<b>b</b> Guide Rail Connector	
<b>c</b> Lever Clamp	

# DIAMOND CORE DRILLING MOTORS

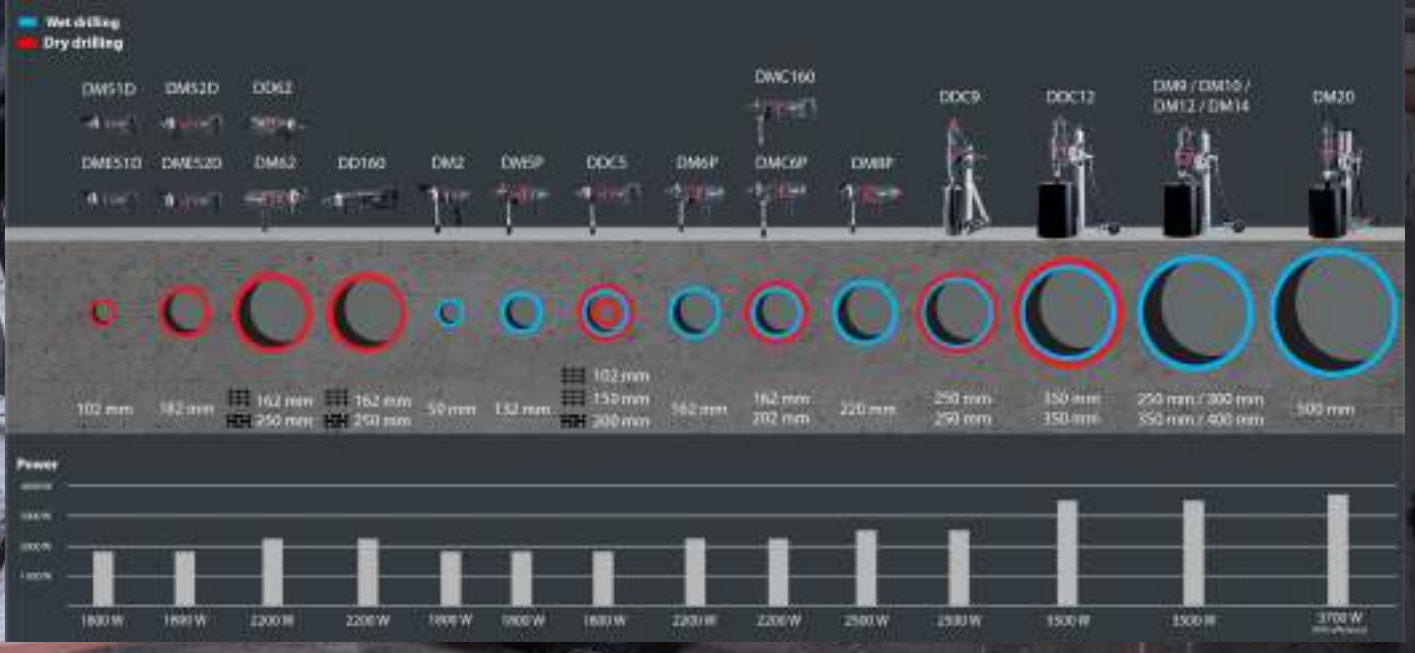



# TC20, TC40, TC402 TILE CORE DRILLS

Wet or dry tile core drills specially designed for core drilling small holes in tiles, ceramics, porcelain, stone, concrete, masonry, glass, and similar materials. Quick-release spindle for easy clearing of cores.



TC20, TC40

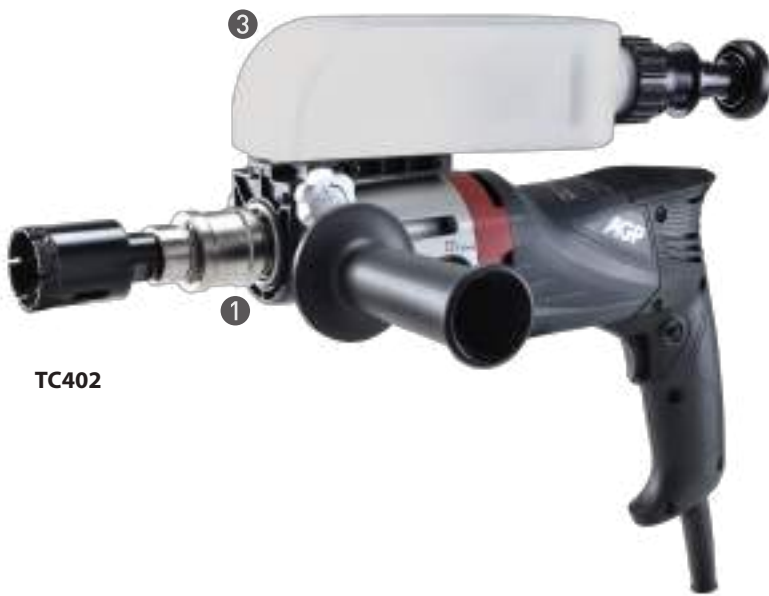

TC402



4 2-speed gear change lever

## Features

1. Quick-release collar for easy clearing of cores.
2. Suction Centering Guide for precise hole positioning and control of slurry and/or dust.
3. Pressurized Water Tank with Flow Regulator (optional).
4. 2-speed motor for a wide range of diameters. (TC402 only).

Model		TC20	TC40	TC402
Power Input		650 W		
Voltage, Frequency		220-240 V~ 50-60 Hz or 110-120 V~ 50-60 Hz		
No Load (Rated Load) Speeds	Gear 1	7500 / (4500) min <sup>-1</sup>	4500 / (2700) min <sup>-1</sup>	4500 / (2700) min <sup>-1</sup>
	Gear 2	N/A	N/A	7500 / (4500) min <sup>-1</sup>
Capacity		20 mm (13/16")	40 mm (1-9/16")	40 mm (1-9/16")
Adapter Thread		G 1/2" (BSP), M14-2.0		
Insulation Class		Class II with PRCD / GFCI		
Neck Diameter		43 mm		
Dimensions (LxWxH)		317 x 100 x 300 mm		348 x 100 x 300 mm
Weight		2.3 kg (5.1 lb)		2.5 kg (5.5 lb)
Characteristics / Certification				

■ **Suction Centering Guide ②**  
(Standard)



Standard Accessories	
PRCD / GFCI Interrupter	
Suction Centering Guide	
Quick-Release Bit Adapter (1/2" BSP)	
Quick-Release Bit Adapter (M14)	
M22 Wrench	
M27 Wrench	
Side handle	
Collar	
Optional Accessories	
Pressurized Water Tank Kit (0.85 Liter)	
Water Supply Kit	

Tile Diamond Core Bits (For models TC20, TC40, TC402)		
Diameter (mm)	Part Number M14-2.0 Thread	Part Number G 1/2" BSP Thread
6	305-03356-004-084	305-03356-004-096
8	305-03356-004-085	305-03356-004-097
10	305-03356-004-086	305-03356-004-098
12	305-03356-004-087	305-03356-004-099
14	305-03356-004-088	305-03356-004-100
16	305-03356-004-089	305-03356-004-101
18	305-03356-004-090	305-03356-004-102
20	305-03356-004-091	305-03356-004-103
25	305-03356-004-092	305-03356-004-104
30	305-03356-004-093	305-03356-004-105
35	305-03356-004-094	305-03356-004-106
40	305-03356-004-095	305-03356-004-107

■ **Water Supply Kit (Optional)**



Tile Diamond Core Bits

# DM51D, DM51P DRY DIAMOND CORE DRILL MOTORS

Light, compact, high efficiency 1800 W coring motors for dry drilling up to 102 mm.



**DM51D**



**DM51P**



### Features

1. Single-speed gearbox with clutch.
2. Electronic motor management with soft start, overload and thermal protection.
3. Horizontal spirit level for precise alignment.
4. The dust and water resistant solid-state switch is more durable and reliable than traditional switches.
5. Switchable soft percussion for optimized dry drilling.
6. Side handle in-line with spindle centerline for best control.

**Standard/ Optional Accessories**  
See p. 56

Model	DM51D	DM51P
Power Input	1800 W	
Voltage, Frequency	220-240 V~ 50-60 Hz or 110-120 V~ 50-60 Hz	
No Load (Rated Load) Speeds	3600 (2160) min <sup>-1</sup>	
Percussion Frequency, No Load (Rated Load)	56,000 (36,400) b/min	
Spindle Thread	1/2" BSP female (also available M18-2.5 male) (Specify when ordering)	
Capacity-Dry (Brick)	102 mm (4")	
Soft Start & Overload Protection	With	
Mechanical Safety Clutch	With	
Insulation Class	Class II	
Neck Diameter	60 mm	60 mm
Dimensions (LxWxH)	450 x 90 x 210 mm	390 x 90 x 280 mm
Weight	4.6 kg	4.6 kg
Characteristics / Certification		

# DM52D, DM52P DRY/WET DIAMOND CORE DRILL MOTORS

Light, high efficiency 1800 W, 2-speed coring motors for dry drilling up to 182 mm and occasional wet drilling up to 82 mm.



**DM52D**



**DM52P**



**Dust aspiration mode**  
Vacuum  
Adaptor Head



**Wet mode**  
Water Feed  
Adaptor Head

Model	DM52D	DM52P
Power Input	1800 W	
Voltage, Frequency	220-240 V~ 50-60 Hz or 110-120 V~ 50-60 Hz	
No Load (Rated Load)	Gear 1	1800 (1080) min <sup>-1</sup>
Speeds	Gear 2	3600 (2160) min <sup>-1</sup>
Percussion Frequency, No Load (Rated Load)	Gear 1	29,000 (18,850) b/min
	Gear 2	56,000 (36,400) b/min
Spindle Thread	1-1/4" UNC male & 1/2" BSP female (also available: 1/2" BSP female or M18-2.5 male) (Specify when ordering)	
Capacity-Dry (Brick)	182 mm (7")	
Capacity-Wet (Reinforced Concrete)	82 mm (3-1/4")	
Soft Start & Overload Protection	With	
Mechanical Safety Clutch	With	
Insulation Class	Class II with PRCD / GFCI	
Neck Diameter	60 mm	60 mm
Dimensions (LxWxH)	505 x 105 x 210 mm	450 x 105 x 280 mm
Weight	5 kg (11.0 lb)	4.9 kg (10.8 lb)
Characteristics / Certification		

## Features

- 2-speed gearbox with clutch for a wide range of sizes.
- Electronic motor management with soft start, overload and thermal protection.
- Horizontal spirit level for precise alignment.
- The dust and water resistant solid-state switch is more durable and reliable than traditional switches.
- Switchable soft percussion for optimized dry drilling.
- Side handle in-line with spindle centerline for best control.

**Standard/ Optional Accessories See p. 56**

## DME51D DRY DIAMOND CORE DRILL MOTOR

A compact, high efficiency 1-speed 1800 W dry drilling motor for drilling up to 102 mm. Suitable for drilling of highly abrasive materials. Switchable soft percussion allows optimal dry drilling performance.



## DME52D DRY DIAMOND CORE DRILL MOTOR

A compact, high efficiency 2-speed 1800 W drilling motor for dry drilling up to 182 mm. Suitable for drilling of highly abrasive materials. Switchable soft percussion allows optimal dry drilling performance.



Model	DME51D	DME52D	
Power Input	1800 W		
Voltage, Frequency	220-240 V~ 50-60 Hz or 110-120 V~ 50-60 Hz		
No Load (Rated Load) Speeds	3600 (2160) min <sup>-1</sup>	Gear 1	1800 (1080) min <sup>-1</sup>
		Gear 2	3600 (2160) min <sup>-1</sup>
Percussion Frequency, No Load (Rated Load)	56,000 (36,400) b/min	Gear 1	29,000 (18,850) b/min
		Gear 2	56,000 (36,400) b/min
Capacity-Dry (Brick)	102 mm (4")		182 mm (7")
Soft Start & Overload Protection	With		
Spindle Thread	M16-2.0 male or M18-2.5 male (Specify when ordering)		
Insulation Class	Class II		
Dimensions (LxWxH)	450 x 90 x 210 mm		505 x 105 x 210 mm
Weight	4.7 kg (10.4 lb)		4.9 kg (10.8 lb)
Characteristics / Certification			

■ **External Dust Extractor Head For Banana Slot Type Bits (Optional)**



Three thread types available:  
 M16 female to M16 male  
 M18 female to M16 male  
 M18 female to M18 male  
 See p. 56



■ **Vacuum Collector Pad (Optional)**

This device adheres to the wall by vacuum cleaner suction and very effectively collects the dust right at the source. Various rings are available for different core sizes. (Details see p. 54)

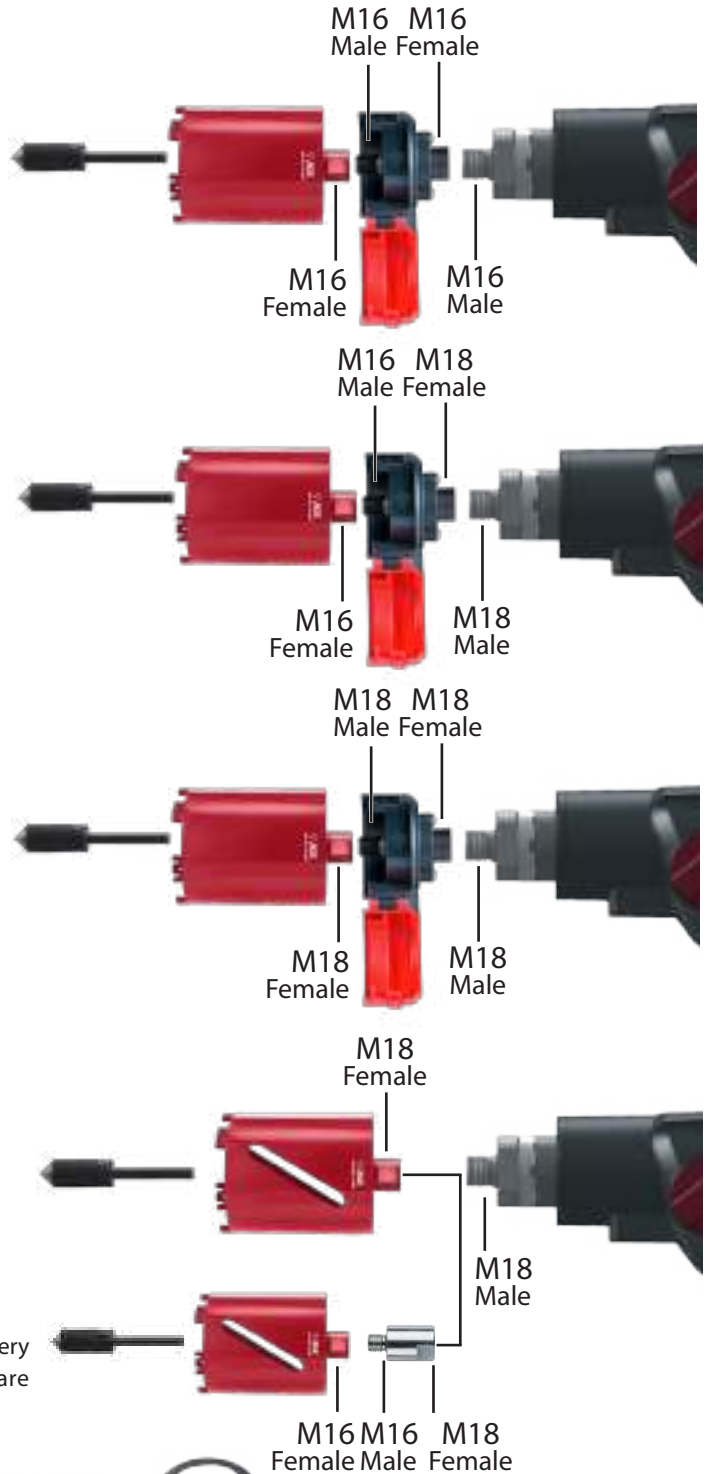

**Features**

1. Gear box with mechanical clutch.
2. Smart Electronic Control with soft-start, thermal protection, and overload protection.
3. Switchable soft percussion for optimized dry drilling.
4. Side Handle in-line with spindle centerline for best control.
5. The dust and water resistant solid-state switch is more durable and reliable than traditional switches.
6. Built in horizontal levels for precision.
7. External Dust Extractor Head for use with 50 to 82 mm banana slot type bits (Optional).
8. Spring-loaded Centering Pilot for L 85mm bits or for L 65mm bits. (Optional).

**Standard/ Optional Accessories See p. 56**

# DD160 DRY DIAMONDCORE DRILL MOTOR FOR REINFORCED CONCRETE

A 2-speed 2200 W dry drilling motor for drilling up to 162 mm in reinforced concrete and 250 mm in brick. Optimized for HVAC applications. Excellent for overhead drilling, operation in sub-zero temperatures and any situation where water cannot be used. Perfect for hollow-core slabs. Through-the-spindle dust extraction and switchable soft percussion allow optimal dry drilling performance.



## Features

1. 2-Speed Gear Box with clutch.
2. Smart Electronic Control with soft-start, thermal protection, and overload protection.
3. Highly visible LED indicator for optimizing drilling efficiency with overload and overheat warning.
4. Switchable soft percussion for optimized dry drilling.
5. The dust and water resistant solid-state switch is more durable and reliable than traditional switches.
6. Anti-seize ring to keep core bits from getting stuck on the spindle.
7. Soft-Grip Side Handle in-line with spindle centerline for best control.
8. Built in horizontal level for precision.

**Standard/ Optional Accessories See p. 56**

Model	DD160	
Power Input	2200 W (230-240 V), 2000 W (220 V), 1700 W (110-120 V)	
Voltage, Frequency	230-240 V~ 50-60 Hz, 220 V~ 50-60 Hz or 110-120 V~ 50-60 Hz	
No Load (Rated Load) Speeds	Gear 1	1250 / (750) min <sup>-1</sup>
	Gear 2	2600 / (1500) min <sup>-1</sup>
Percussion Frequency, No Load (Rated Load)	Gear 1	25,000 (15,000) b/min
	Gear 2	50,000 (30,000) b/min
Capacity-Dry (Reinforced Concrete)	162 mm (6-1/2")	
Capacity-Dry (Brick)	250 mm (10")	
Soft Start & Overload Protection	With	
Gear Oil Type	80W-90	
Gear Oil Capacity	200 ml	
Spindle Thread	1-1/4" UNC male & 1/2" BSP female	
Insulation Class	Class II	
Dimensions (LxWxH)	550 x 130 x 160 mm	
Weight	6.0 kg (13.2 lb)	
Characteristics / Certification		

# DD62 DRY DIAMOND CORE DRILL MOTOR FOR REINFORCED CONCRETE

A heavy-duty 2-speed 2200 W dry drilling motor for drilling up to 162 mm in reinforced concrete and 250 mm in brick. Excellent for overhead drilling, operation in sub-zero temperatures and any situation where water cannot be used. Perfect for hollow-core slabs. Through-the-spindle dust extraction and switchable soft percussion allow optimal dry drilling performance.



## Features

1. 2-Speed Gear Box with clutch.
2. Smart Electronic Control with soft-start, thermal protection, and overload protection.
3. All metal construction for optimized cooling, durability, and maximum strength.
4. Switchable soft percussion for optimized dry drilling.
5. LED indicator for optimizing drilling efficiency with overload and overheat warning.
6. The dust and water resistant solid-state switch is more durable and reliable than traditional switches.
7. Anti-seize ring to keep core bits from getting stuck on the spindle.
8. Side Handle in-line with spindle centerline for best control.
9. Built in vertical and horizontal levels for precision.

**Standard/ Optional Accessories See p. 56**

Model	DD62
Power Input	2200 W (230-240 V), 2000 W (220 V), 1700 W (110-120 V)
Voltage, Frequency	230-240 V~ 50-60 Hz, 220 V~ 50-60 Hz or 110-120 V~ 50-60 Hz
No Load (Rated Load) Speeds	Gear 1 1250 (750) min <sup>-1</sup> Gear 2 1900 (1140) min <sup>-1</sup>
Percussion Frequency, No Load (Rated Load)	Gear 1 25,000 (16,250) b/min Gear 2 38,000 (24,700) b/min
Capacity-Dry (Reinforced Concrete)	162 mm (6-1/2")
Capacity-Dry (Brick)	250 mm (10")
Soft Start & Overload Protection	With
Gear Oil Type	80W-90
Gear Oil Capacity	200 ml
Spindle Thread	1-1/4" UNC male & 1/2" BSP female
Insulation Class	Class II
Dimensions (LxWxH)	530 x 130 x 215 mm
Weight	6.5 kg (14.3 lb)
Characteristics / Certification	

# DM62 DRY DIAMOND CORE DRILL MOTOR FOR REINFORCED CONCRETE

A heavy-duty 2-speed 2200 W dry drilling motor for drilling up to 162 mm in reinforced concrete and 250 mm in brick. Excellent for overhead drilling, operation in sub-zero temperatures and any situation where water cannot be used. Perfect for hollow-core slabs. Through-the-spindle dust extraction and switchable soft percussion allow optimal dry drilling performance.





DM62



DM62+AS200

## Features

1. 2-Speed Gear Box with clutch.
2. Smart Electronic Control with soft-start, thermal protection, and overload protection.
3. All metal construction for optimized cooling, durability, and maximum strength.
4. Switchable soft percussion for optimized dry drilling.
5. LED indicator for optimizing drilling efficiency with overload and overheat warning.
6. The dust and water resistant solid-state switch is more durable and reliable than traditional switches.
7. Anti-seize ring to keep core bits from getting stuck on the spindle.
8. Side Handle in-line with spindle centerline for best control.
9. Built in vertical and horizontal levels for precision.

**Standard/ Optional Accessories See p. 56**

Model	DM62	
Power Input	2200 W (230-240 V), 2000 W (220 V), 1700 W (110-120 V)	
Voltage, Frequency	230-240 V~ 50-60 Hz, 220 V~ 50-60 Hz or 110-120 V~ 50-60 Hz	
No Load (Rated Load) Speeds	Gear 1	1250 (750) min <sup>-1</sup>
	Gear 2	1900 (1140) min <sup>-1</sup>
Percussion Frequency, No Load (Rated Load)	Gear 1	25,000 (16,250) b/min
	Gear 2	38,000 (24,700) b/min
Capacity-Dry (Reinforced Concrete)	162 mm (6-1/2")	
Capacity-Dry (Brick)	250 mm (10")	
Soft Start & Overload Protection	With	
Gear Oil Type	80W-90	
Gear Oil Capacity	200 ml	
Spindle Thread	1-1/4" UNC male & 1/2" BSP female	
Insulation Class	Class II	
Dimensions (LxWxH)	430 x 122 x 290 mm	
Weight	6.3 kg (13.6 lb)	
Characteristics / Certification		

## DM2 WET DIAMOND CORE DRILL MOTOR

A compact 1-speed 1800 W wet drilling motor designed for fast wet drilling of small diameters from 10 mm up to 50 mm in reinforced concrete. Handles rebar well and is ideal for chemical anchors and similar applications.



Model	DM2
Power Input	1800 W
Voltage, Frequency	220-240 V~ 50-60 Hz or 110-120 V~ 50-60 Hz
No Load (Rated Load) Speed	6500 (4225) min <sup>-1</sup>
Capacity-Wet (Reinforced Concrete)	50 mm (2")
Spindle Thread	1/2" BSP Female
Soft Start & Overload Protection	With
Mechanical Safety Clutch	With
Neck Diameter	60 mm
Insulation Class	Class II with PRCD / GFCI
Dimensions (LxWxH)	360 x 90 x 280 mm
Weight	4.5 kg (9.9 lb)
Characteristics / Certification	

### Features

1. 1-speed Gear Box with clutch.
2. Smart Electronic Control with thermal protection and overload protection.
3. Side Handle in-line with spindle centerline for best control.
4. Built in horizontal levels for precision.

**Standard/ Optional Accessories**  
See p. 59

# DM5P, DM5D WET DIAMOND CORE DRILL MOTORS

A compact, high efficiency 2-speed 1800 W wet drilling motor for drilling up to 132 mm.



DM5P



DM5D



## Features

1. 2-speed Gear Box with clutch.
2. Smart Electronic Control with thermal protection and overload protection.
3. Side Handle in-line with spindle centerline for best control.
4. Built in horizontal levels for precision.
5. The dust and water resistant solid-state switch is more durable and reliable than traditional switches.

Model	DM5P	DM5D
Power Input	1800 W	
Voltage, Frequency	220-240 V~ 50-60 Hz or 110-120 V~ 50-60 Hz	
No Load (Rated Load) Speeds	Gear 1 1500 (780) min <sup>-1</sup> Gear 2 2500 (1400) min <sup>-1</sup>	
Capacity-Wet (Reinforced Concrete)	132 mm (5-1/4")	
Spindle Thread	1-1/4" UNC male & 1/2" BSP female	
Neck Diameter	60 mm	
Insulation Class	Class II with PRCD / GFCI	
Dimensions (LxWxH)	450 x 105 x 280 mm	505 x 105 x 210 mm
Weight	5.35 kg (11.8 lb)	5.46 kg (12.0 lb)
Characteristics / Certification		

Standard/ Optional Accessories See p. 59

## DMC160 WET / DRY DIAMOND CORE DRILL MOTOR

A 3-speed 2200 W wet and dry drilling motor for drilling up to 162 mm in wet, and 202 mm in dry. An excellent choice for an all-around tool for many tasks.



Model	DMC160
Power Input	2200 W (230-240 V), 2000 W (220 V), 1700 W (110-120 V)
Voltage, Frequency	230-240 V~ 50-60 Hz, 220 V~ 50-60 Hz or 110-120 V~ 50-60 Hz
No Load Speeds	1000 / 1600 / 460 0 min <sup>-1</sup>
Rated Load Speeds	650 / 1040 / 2890 min <sup>-1</sup>
Capacity-Wet (Reinforced Concrete)	Hand-Held : 82 mm (3-1/4") Rig-Mounted : 162 mm (6-1/2")
Capacity-Dry (Brick)	202 mm (8")
Gear Oil Type	80W-90
Gear Oil Capacity	200 ml
Spindle Thread External / Internal	1-1/4" UNC male & 1/2" BSP female
Neck Diameter	60 mm
Soft Start & Overload Protection	With
Mechanical Safety Clutch	With
Insulation Class	Class II with PRCD / GFCI
Dimensions (LxWxH)	528 x 106 x 145 mm
Weight	5.8 kg (12.8 lb)
Characteristics / Certification	

**Brass Claw-Type Couplings**



Mounted to AS200 Drill Stand + Water Collector + VB400 Vacuum Plate (See p. 64)

**Features**

1. 3-Speed Gear Box with clutch.
2. Smart Electronic Control with soft start, thermal protection, and overload protection.
3. Highly visible LED indicator for optimizing drilling efficiency with overload and overheat warning.
4. The dust and water resistant solid-state switch is more durable and reliable than traditional switches.
5. Anti-seize ring to keep core bits from getting stuck on the spindle.
6. Side Handle in-line with spindle centerline for best control.
7. Built in horizontal level for precision.

**Standard/ Optional Accessories See p. 58**

## DM6P, DM6D WET DIAMOND CORE DRILL MOTORS

A heavy duty 3-speed 2200 W wet drilling motor for wet drilling up to 162 mm. Featuring all-metal construction for optimized cooling, durability, and maximum strength.



## DMC6P, DMC6D WET / DRY DIAMOND CORE DRILL MOTORS

A heavy duty 3-speed 2200 W wet and dry drilling motor for drilling up to 162 mm in wet, and 202 mm in dry. Featuring all-metal construction for optimized cooling, durability, and maximum strength.



**Brass Claw-Type Couplings**



Mounted to AS200 Drill Stand (See p. 62)

**Features**

1. Aluminum alloy construction for optimized cooling, durability, and light weight.
2. Smart electronic motor management with soft start, overload and thermal protection.
3. 3-speed oil bath gearbox with clutch.
4. Side handle in-line with spindle centerline for best control.
5. LED Indicator clearly indicates load conditions.
6. Water supply kit with quick-release water hose adaptor.
7. Anti-seize ring to keep core bits from getting stuck on the spindle.
8. Vertical and horizontal levels for precision.
9. The dust and water resistant solid-state switch is more durable and reliable than traditional switches.

**Standard/ Optional Accessories See p. 58~59**

Model	DM6P	DM6D	DMC6P	DMC6D
Power Input	2200 W (230-240 V), 2000 W (220 V), 1700 W (110-120 V)			
Voltage, Frequency	230-240 V~ 50-60 Hz, 220 V~ 50-60 Hz or 110-120 V~ 50-60 Hz			
No Load Speeds	930 / 1520 / 4270 min <sup>-1</sup>			
Rated Load Speeds	560 / 910 / 2560 min <sup>-1</sup>			
Capacity-Wet (Reinforced Concrete)	Hand-Held : 82 mm (3-1/4") Rig-Mounted : 162 mm (6-1/2")			
Capacity-Dry (Brick)	N/A	N/A	202 mm (8")	202 mm (8")
Gear Oil Type	80W-90			
Gear Oil Capacity	200 ml			
Spindle Thread External / Internal	1-1/4" UNC male & 1/2" BSP female			
Neck Diameter	60 mm			
Soft Start & Overload Protection	With			
Mechanical Safety Clutch	With			
Insulation Class	Class I with PRCD / GFCI			
Dimensions (LxWxH)	437 x 115 x 289 mm	528 x 106 x 145 mm	437 x 115 x 289 mm	528 x 106 x 145 mm
Weight	6.3 kg (13.9 lb)	6.3 kg (13.9 lb)	6.4 kg (14.1 lb)	6.4 kg (14.1 lb)
Characteristics / Certification				

# DM8P WET DIAMOND CORE DRILL MOTOR

A heavy duty 3-speed 2500 W wet drilling motor for drilling up to 220 mm. Featuring constant speed electronics for even drilling speed and longer core bit life.



## Features

1. High output motor with Constant Speed Electronics.
2. Smart Electronic Control with soft-start, thermal protection, and overload protection.
3. 3-speed oil bath gear box with clutch.
4. Highly visible LED load indicator for optimizing drilling efficiency.
5. Anti-seize ring to keep core bits from getting stuck on the spindle.
6. Side handle in-line with spindle centerline for best control.
7. The dust and water resistant solid-state switch is more durable and reliable than traditional switches.

**Standard/ Optional Accessories See p. 59**

Model	DM8P
Power Input	2500 W (220 V), 2200 W (110 V)
Voltage, Frequency	220-240 V~ 50-60 Hz or 110-120 V~ 50-60 Hz
No Load Speeds	480 / 1050 / 2200 min <sup>-1</sup>
Rated Load Speeds	320 / 700 / 1450 min <sup>-1</sup>
Capacity-Wet (Reinforced Concrete)	Hand-Held: 82 mm (3-1/4") Rig-Mounted: 220 mm (9 ")
Soft Start & Overload Protection	With
Gear Oil Type	80W-90
Gear Oil Capacity	300 ml
Spindle Thread External / Internal	1-1/4" UNC male & 1/2" BSP female
Neck Diameter	60 mm
Insulation Class	Class I with PRCD / GFCI
Dimensions (LxWxH)	463 x 127 x 310 mm
Weight	7.3 kg (16.0 lb)
Characteristics / Certification	

# DDC5 SOFT PERCUSSION DIAMOND CORE DRILL MOTOR FOR BOTH WET & DRY DRILLING

A compact 2-speed 1800 W hybrid drilling motor for drilling wet or dry in reinforced concrete or brick. Its soft percussion function enhances both dry and wet drilling. Its convertible port allows vacuum connection for dry drilling, and water feed for wet drilling. This unprecedented combination of features and capabilities delivers unmatched versatility in a lightweight package.



Model	DDC5	
Power Input	1800 W	
Voltage, Frequency	220-240 V~ 50-60 Hz or 110-120 V~ 50-60 Hz	
No Load (Rated Load)	Gear 1	1500 (780) min <sup>-1</sup>
Speeds	Gear 2	2500 (1400) min <sup>-1</sup>
Percussion Frequency, No Load (Rated Load)	Gear 1	30,000 (15,600) b/min
	Gear 2	50,000 (28,000) b/min
Spindle Thread	1-1/4" UNC male & 1/2" BSP female	
Capacity-Wet (Reinforced Concrete)	Ø132 mm (5-1/4") / + percussion: Ø150 mm (6")	
Capacity-Dry (Brick)	Ø 200 mm (8")	
Capacity-Dry (Reinforced Concrete)	Ø 102 mm (4")	
Soft Start & Overload Protection	With	
Mechanical Safety Clutch	With	
Insulation Class	Class II with PRCD / GFCI	
Neck Diameter	60 mm	
Dimensions (LxWxH)	505 x 105 x 210 mm	
Weight	5 kg (11.0 lb)	
Characteristics / Certification		

## Features

1. 2-speed gearbox with clutch for a wide range of sizes.
2. Electronic motor management with soft start, overload and thermal protection.
3. Highly visible LED load indicator for optimizing drilling efficiency.
4. The dust and water resistant solid-state switch is more durable and reliable than traditional switches.
5. Switchable soft percussion for optimized dry drilling.
6. Side handle in-line with spindle centerline for best control.
7. Horizontal spirit level for precise alignment.

Standard/ Optional Accessories See p. 58

# DDC9 SOFT PERCUSSION DIAMOND CORE DRILL MOTOR FOR BOTH DRY & WET DRILLING

A heavy-duty 3-speed 2500 W combined dry and wet drilling motor for drilling up to 250 mm dry or wet in reinforced concrete. Its soft percussion function enhances both dry and wet drilling. Its convertible port allows vacuum connection for dry drilling, and water feed for wet drilling, allowing the motor to keep its wet drilling capabilities, while adding the capability to drill reinforced concrete dry. Wide speed range allows outstanding performance with small and medium diameters.



## Features

1. High output motor with Constant Speed Electronics.
2. Smart Electronic Control with soft-start, thermal protection, and overload protection.
3. 3-speed oil bath gear box with clutch.
4. Highly visible LED load indicator for optimizing drilling efficiency.
5. Switchable soft percussion enhances both dry and wet drilling performance.
6. Anti-seize ring to keep core bits from getting stuck on the spindle
7. Convertible port for both dust collection and water feed.
8. Horizontal and vertical spirit levels for accurate alignment
9. The dust and water resistant solid-state switch is more durable and reliable than traditional switches. The switch also features anti-restart function.

**Standard/ Optional Accessories See p. 58**

Model	DDC9
Power Input	2500 W (220 V), 2200 W (110 V)
Voltage, Frequency	220-240 V~ 50-60 Hz or 110-120 V~ 50-60 Hz
No Load Speeds	480 / 1050 / 2200 min <sup>-1</sup>
Rated Load Speeds	320 / 700 / 1450 min <sup>-1</sup>
Percussion Frequency, Rated Load	7,680 / 16,800 / 34,800 b/min
Capacity-Dry (Reinforced Concrete)	Ø 250 mm (10")
Capacity-Wet (Reinforced Concrete)	Ø 220 mm (9") / + percussion: Ø 250 mm (10")
Soft Start & Overload Protection	With
Gear Oil Type	80W-90
Gear Oil Capacity	240 ml
Spindle Thread External / Internal	1-1/4" UNC male & 1/2" BSP female
Insulation Class	Class I with PRCD / GFCI
Dimensions (LxWxH)	585 x 126 x 170 mm
Weight	10.5 kg (23.1 lb)
Characteristics / Certification	

# DDC12 SOFT PERCUSSION DIAMOND CORE DRILL MOTOR FOR BOTH DRY & WET DRILLING

A heavy-duty 3-speed 3500 W combined dry and wet drilling motor for drilling up to 350 mm dry or wet in reinforced concrete. Its soft percussion function and convertible port allows vacuum connection for dry drilling, and water feed for wet drilling, allowing the motor to keep its wet drilling capabilities, while adding the capability to dry drill reinforced concrete.



## Features

1. Anti-seize ring to keep core bits from getting stuck on the spindle.
2. Switchable Soft Percussion for effective dry drilling.
3. Sturdy 3-speed Gear Box with oil bath lubrication and mechanical clutch.
4. Advanced Electronic Control with soft-start, thermal protection, and overload protection.
5. Slow-Start function, a unique automatic hole starting function that reduces motor speed for a short time to allow the kerf to be started.
6. Aluminum housing for better cooling and durability.
7. Vertical and horizontal levels for precision.
8. LED Load Indicator for visual monitoring of load conditions.
9. The dust and water resistant solid-state switch is more durable and reliable than traditional switches. The switch also features anti-restart function.
10. Convertible Port for vacuum connection or water supply.
11. Quick-Release Water Feed and Vacuum Adapter Heads.

**Standard/ Optional Accessories See p. 58**

Model	DDC12
Power Input	3500 W / 16 A (230 V), 2800 W / 25 A (110 V)
Voltage, Frequency	220-240 V~ 50-60 Hz or 110-120 V~ 50-60 Hz
No Load Speeds	450 / 810 / 1300 min <sup>-1</sup>
Rated Load Speeds	270 / 480 / 780 min <sup>-1</sup>
Percussion Frequency, Rated Load	6,480 / 11,520 / 18,720 b/min
Capacity-Dry (Reinforced Concrete)	Ø350 mm (14")
Capacity-Wet (Reinforced Concrete)	Ø300 mm (12") / + percussion: Ø350 mm (14")
Gear Oil Type	80W-90
Gear Oil Capacity	625 ml
Spindle Thread	1-1/4" UNC male & 1/2" BSP female
Insulation Class	Class I with PRCD / GFCI (110-120V w/o PRCD / GFCI)
Soft Start & Overload Protection	With
Dimensions (LxWxH)	623 x 149 x 213 mm
Weight	13 kg (28.6 lb)
Characteristics / Certification	

## DM9, DM10, DM12 DIAMOND CORE DRILL MOTORS

High efficiency 3-speed, 3500 W rig-mounted drilling motors with aluminum body. Three models with optimized gearing for different drilling requirements. Choose the version which best suits your drilling needs.



## DM14 RIG-MOUNTED DIAMOND CORE DRILL MOTOR

A high efficiency 4-speed, 3500 W motor with Aluminum body, optimized for a wider range of drill sizes in one tool.





■ **Optional Accessories: 40 mm Spacer Kit**

To provide clearance for the switch box when mounting the motor to some models of other manufacturers' rigs. (The spacer also adds an extra 80 mm to the maximum core bit diameter with a given stand.)

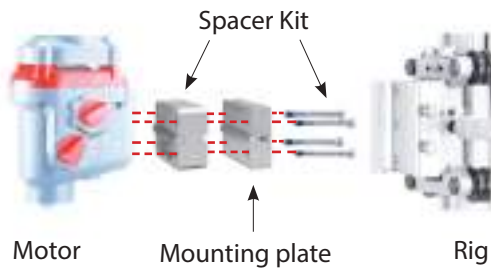

**Standard/ Optional Accessories See p. 59**

1. Sturdy 4-speed Gear Box with oil bath lubrication and mechanical clutch.
2. Advanced Electronic Control with soft-start, thermal protection, and overload protection.
3. LED Load Indicator for visual monitoring of load conditions.
4. Slow-Start function, a unique automatic hole starting function that reduces motor speed for a short time to allow the kerf to be started.
5. Vertical and horizontal levels for precision.
6. Aluminum housing for better cooling and durability.
7. Anti-seize ring to keep core bits from getting stuck on the spindle.
8. Quick-replaceable water seals.
9. The dust and water resistant solid-state switch is more durable and reliable than traditional switches. The switch also features anti-restart function.

Model	DM9	DM10	DM12	DM14
Power Input	3500 W / 16 A (220 V), 2800 W / 25 A (110 V)			
Voltage, Frequency	220-240 V~ 50-60 Hz or 110-120 V~ 50-60 Hz			
No Load Speeds	550 / 1000 / 1600 min <sup>-1</sup>	450 / 810 / 1300 min <sup>-1</sup>	350 / 600 / 1000 min <sup>-1</sup>	385 / 530 / 975 / 1340 min <sup>-1</sup>
Rated Load Speeds	345 / 630 / 1000 min <sup>-1</sup>	270 / 480 / 780 min <sup>-1</sup>	220 / 370 / 620 min <sup>-1</sup>	225 / 300 / 565 / 780 min <sup>-1</sup>
Drilling Capacity (Reinforced Concrete)	Ø250 mm (10")	Ø300 mm (12")	Ø350 mm (14")	Ø400 mm (16")
Gear Oil Type	80W-90			
Gear Oil Capacity	625 ml			
Spindle Thread	1-1/4" UNC male & 1/2" BSP female			
Insulation Class	Class I with PRCD / GFCI (110-120V w/o PRCD / GFCI)			
Soft Start & Overload Protection	With			
Dimensions (LxWxH)	550 x 155 x 210 mm			
Weight	12.3 kg (27.1 lb)			13.5 kg (29.7 lb)
Characteristics / Certification				

# DM20 INTEGRATED HIGH-FREQUENCY DIAMOND CORE DRILL MOTOR

The water-cooled permanent magnet synchronous motor provides unprecedented power output efficiency on single phase supply for outstanding performance with large diameters up to 500 mm (20"). The 17-speed integrated controller allows a wide speed range with full torque available at every speed.





**Features**

1. Water-cooled PMSM motor has the highest output efficiency of any single phase coring motor on the market.
2. Conveniently runs directly on dual voltage (230 V & 110 V) single phase supply. The power converter is integrated into the unit, and the automatic PRCD is built-in as well, so you can just plug it in and start drilling!
3. Oil bath gearbox with mechanical clutch. Due to the special motor characteristics which allow electronic speed selection with no loss of torque, only one mechanical ratio is needed.
4. Anti-seize ring to prevents core bits from getting stuck on the spindle.
5. Water feed inlet can be mounted on either side of the motor for operator convenience.
6. Easy to use operator interface.
7. The Ferro-Fix rebar assist button makes it much easier to handle embedded steel while drilling.
8. LED display gives bit diameter, as well as mode display, service indicator, hours counter, and error codes.
9. The separate LED load indicator lamp gives reliable information on load and thermal conditions.
10. The electronic speed selection with 17 diameter settings are easy to select, and can be adjusted on the fly. Can be easily changed between metric and inch display units.
11. Bit threading function makes threading on large heavy bits much easier. Simply align the spindle with the bit, press the button once, and it will automatically rotate at low speed to thread the bit on. Press the button once again to stop.

**Standard/ Optional Accessories See p. 59**

Model	DM20
Power Input	3500 W (230 V) / 2750 W (110 V)
Power Output Efficiency	90%
Voltage, Frequency	1φ~ 220-240 V / 100-120 V, 50-60 Hz
Rated Load Speeds*	220 - 540 min <sup>-1</sup>
Electronic Speed Settings	17 steps
Drilling Capacity (Reinforced Concrete)	Ø500 mm (20")
Soft Start & Overload Protection	With
Gear Oil Type	80W-90
Gear Oil Capacity	400 ml
Spindle Thread	1-1/4" UNC
Insulation Class	Class I with PRCD
Ingress Protection Class	IP55
Dimensions (LxWxH)	669 x 221 x 182 mm
Weight	16.7 kg (36.7 lb)
Characteristics / Certification	

\* Due to the constant speed motor design, the no load speeds and rated load speeds are the same.

# Dry Drilling Accessories

## DM51 Dry Diamond Core Drill Motor

Standard Accessories	
Side Handle	
Percussion Selector	
Optional Accessories	
Soft-Grip Side Handle	



**a** SDS Pilot Drill Socket

## DM52 Diamond Core Drill Motor

Standard Accessories	
Side Handle	
Water Feed Adaptor Head	
Vacuum Adaptor Head	
<b>b</b> PRCD / GFCI Interrupter	
Optional Accessories	Part Number
Soft-Grip Side Handle	
<b>a</b> SDS Pilot Drill Socket	302-04387-907-001



**b** PRCD / GFCI Interrupter



**c1** Centering Pilot

## DME51, DME52 Dry Diamond Core Drill Motors

Standard Accessories	
Side Handle	
Optional Accessories	Part Number
<b>e</b> M18 to M16 Spindle Adaptor	302-04311-903-009
Vacuum Collector Pad Set (See p.54)	
<b>c1</b> Centering Pilot for L 85 mm bits	0202-0111-00000-014
<b>c1</b> Centering Pilot for L 65 mm bits	0202-0111-00000-015
<b>d</b> External Dust Extractor Head (for banana slot bits)	
M16 female to M16 male	0299-0295-00000-016
M18 female to M18 male	0299-0295-00000-012
M18 female to M16 male	0299-0295-00000-011
(choose desired thread when ordering)	



**c2** L 300 mm Centering Pilot



**d** External Dust Extractor Head  
(Three thread types available)

## DM62, DD62, DD160 Dry Diamond Core Drill Motors

Standard Accessories	
Blow Molded Case	
Side Handle	
M32 Wrench	
Optional Accessories	Part Number
<b>c2</b> Centering Pilot for L 300 mm Bits	0202-0111-00000-001



**e** M18 to M16 Spindle Adaptor

# DDC5, DM52, DM62, DD62, DD160, DMC6, DMC160

## Dry Drilling Accessories

ADD quick release dry drilling equipment			Part Number
①	Centering pilot, ADD		0202-0111-00000-009
②	Extension 200 mm		0299-0114-00000-005
③	ADD quick release		0299-0114-00000-004
④	1-1/4" to ADD M42 Adaptor		301-03022-000-003
Dry Diamond Core Bits with ADD M42 Coupling (Brick)			Part Number
Diameter(mm)	Coupling	Useful Length(mm)	
56	ADD	200	305-91042-200-056
68	ADD	200	305-91042-200-068
82	ADD	200	305-91042-200-082
102	ADD	200	305-91042-200-102
112	ADD	200	305-91042-200-112
132	ADD	200	305-91042-200-132
162	ADD	200	305-91042-200-162
172	ADD	200	305-91042-200-172
182	ADD	200	305-91042-200-182
M16 dry drilling equipment			Part Number
⑤	Centering Pilot for L 85 mm bits		0202-0111-00000-014
⑥	M16 Dust Extractor (for banana slot bits)		0299-0114-00000-008
⑦	1-1/4" to M16 Adaptor		301-03022-000-005
Dry Diamond Core Bits with M16 Coupling (Brick)			Part Number
Diameter(mm)	Coupling	Useful Length(mm)	
68	M16	85	305-91016-085-068
82	M16	85	305-91016-085-082
102	M16	85	305-91016-085-102
112	M16	85	305-91016-085-112

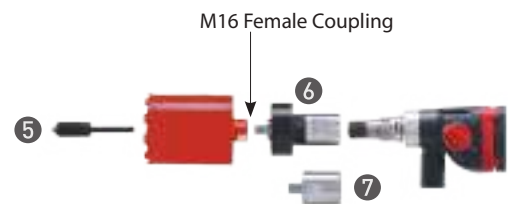
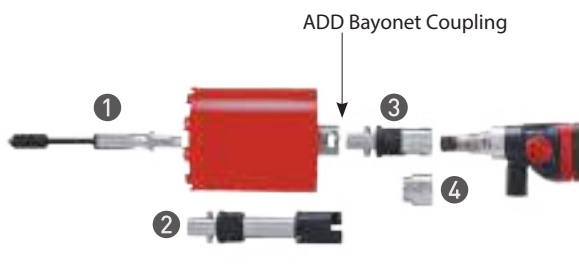

Dry-Type Diamond Core Bits (For models with M16 coupling) (Brick)		
Diameter (mm)	Part Number 150 mm Length	Part Number 250 mm Length
32	305-03356-004-068	305-03356-004-108
38	305-03356-004-069	305-03356-004-109
42	305-03356-004-070	305-03356-004-110
52	305-03356-004-071	305-03356-004-111
62	305-03356-004-072	305-03356-004-112
65	305-03356-004-073	305-03356-004-113
72	305-03356-004-074	305-03356-004-114
78	305-03356-004-075	305-03356-004-115
82	305-03356-004-076	305-03356-004-116
86	305-03356-004-077	305-03356-004-078



# Wet / Dry Drilling Accessories

## DMC160 Wet / Dry Diamond Core Drill Motors

Standard Accessories	
Side Handle	
Water Supply Kit	
M32 Wrench	
<b>b</b> PRCD / GFCI Interrupter	
<b>f</b> Brass Claw-Type Couplings	
Optional Accessories	Part Number
Soft-Grip Side Handle	
<b>a</b> SDS Pilot Drill Socket	302-04387-907-001
<b>c2</b> Centering Pilot for L 300mm Bits	0202-0111-00000-001



**a** SDS Pilot Drill Socket



**b** PRCD / GFCI Interrupter

## DMC6 Wet / Dry Diamond Core Drill Motors

Standard Accessories	
Side Handle	
Water Supply Kit	
M32 Wrench	
<b>b</b> PRCD / GFCI Interrupter	
<b>f</b> Brass Claw-Type Couplings	
Optional Accessories	Part Number
Soft-Grip Side Handle	
<b>a</b> SDS Pilot Drill Socket	302-04387-907-001
<b>c2</b> Centering Pilot for L 300mm Bits	0202-0111-00000-001



**c2** L 300 mm Centering Pilot

## DDC5 Wet / Dry Diamond Core Drill Motor

Standard Accessories	
Side Handle	
Water Feed Adaptor Head	
Vacuum Adaptor Head	
<b>b</b> PRCD / GFCI Interrupter	
Optional Accessories	Part Number
Soft-Grip Side Handle	
<b>a</b> SDS Pilot Drill Socket	302-04387-907-001



**f** Brass Claw-Type Couplings

## DDC9 Wet / Dry Diamond Core Drill Motor

Standard Accessories	
Water Feed Adaptor Head	
Vacuum Adaptor Head	
<b>b</b> PRCD / GFCI Interrupter	



**g** 40 mm Spacer Kit

## DDC12 Wet / Dry Diamond Core Drill Motor

Standard Accessories	
Water Feed Adaptor Head	
Vacuum Adaptor Head	
<b>b</b> PRCD / GFCI Interrupter	
Optional Accessories	Part Number
<b>g</b> 40 mm Spacer Kit	0299-0214-0000-001

# Wet Drilling Accessories

## DM2 Wet Diamond Core Drill Motors

Standard Accessories	
Side Handle	
Water Supply Kit	
<b>b</b> PRCD / GFCI Interrupter	
Optional Accessories	Part Number
Soft-Grip Side Handle	



**a** SDS Pilot Drill Socket

## DM5 Wet Diamond Core Drill Motors

Standard Accessories	
Blow Molded Case	
Side Handle	
Water Supply Kit	
<b>b</b> PRCD / GFCI Interrupter	
Optional Accessories	Part Number
Soft-Grip Side Handle	
<b>a</b> SDS Pilot Drill Socket	302-04387-907-001



**b** PRCD / GFCI Interrupter

## DM6 Wet Diamond Core Drill Motors

Standard Accessories	
Side Handle	
Water Supply Kit	
M32 Combination Wrench	
<b>b</b> PRCD / GFCI Interrupter	
Optional Accessories	Part Number
Soft-Grip Side Handle	
<b>a</b> SDS Pilot Drill Socket	302-04387-907-001



**g** 40 mm Spacer Kit

## DM8P Wet Diamond Core Drill Motor

Standard Accessories	
Blow Molded Case	
Side Handle	
Water Supply Kit	
M32 Wrench	
<b>b</b> PRCD / GFCI Interrupter	

## DM9, 10, 12 , 14 Diamond Core Drill Motors

Standard Accessories	
Water Supply Kit	
<b>b</b> PRCD / GFCI Interrupter	
Remark: 110-120V W/O PRCD / GFCI	
Optional Accessories	Part Number
<b>g</b> 40 mm Spacer Kit	0299-0214-0000-001

## DM20 High Frequency Diamond Core Drill Motor

Standard Accessories	
Water Supply Kit	
Optional Accessories	Part Number
<b>g</b> 40 mm Spacer Kit	0299-0214-0000-001

# Drilling Accessories

Drilling Series Optional Accessories	Part Number
<b>a</b> SDS Pilot Drill Socket (for models with female 1/2" BSP spindles)	302-04387-907-001
<b>h</b> Acme Thread Adaptor (Adapts 1-1/4"-7 UNC spindles to 1-1/4"-3 Acme)	302-04311-901-002
<b>i</b> M16 Dry Arbor Adaptor (Adapts 1-1/4"-7 UNC spindles to M16-2.0)	302-04311-000-002



**a** SDS Pilot Drill Socket

Vacuum Collector Pad	Part Number
<b>j</b> Vacuum Collector Pad Set (small, max. 82 mm) *Set includes pad + 4 rings	0299-0113-00000-002
<b>k</b> Vacuum Collector Pad Set (large, max. 150 mm) *Set includes pad + 2 rings	0299-0113-00000-001
<b>l</b> Ring (Ø45) - for small pad	303-02034-004-003
Ring (Ø55) - for small pad	303-02034-004-004
Ring (Ø65) - for small pad	303-02034-004-005
Ring (Ø75) - for small pad	303-02034-004-006
<b>m</b> Ring (Ø110) - for large pad	303-02034-004-001
Ring (Ø130) - for large pad	303-02034-004-002



**h** Acme Thread Adaptor



**i** M16 Dry Arbor Adaptor

# Special Clutch Tools

Torque Wrench Adapter Socket (for checking the clutch's slipping torque)	Part Number
For DD160, DD62, DM62, DM6D, DM6P, DMC6D, DMC6P, DMC160	0202-0117-00000-010
For DM5D, DDC5, DM5P, DM51D, DM51P, DM52D, DM52P, DME51D, DME52D	0202-0117-00000-011
<b>n</b> For DM9, DM10, DM12, DM14, DDC12	0202-0117-00000-013
For DM2	0202-0117-00000-014
For DM8P, DDC9	0202-0117-00000-015
For DM20	0202-0117-00000-017



**j** Vacuum Collector Pad (small)



**k** Vacuum Collector Pad (large)

Holding Fixture for adjusting clutches (to safely hold the shaft without damaging it)	Part Number
For DM51D, DM51P, DM52D, DM52P, DME51D, DME52D	0202-0117-00000-001
For DM6D, DM6P, DMC6D, DMC6P, DMC160	0202-0117-00000-002
For DM9, DM10, DM12, DDC12	0202-0117-00000-003
For DM14	0202-0117-00000-004
<b>o</b> For DM2	0202-0117-00000-006
For DM5D, DDC5, DM5P, DD160	0202-0117-00000-007
For DD62, DM62	0202-0117-00000-008
For DM8P, DDC9	0202-0117-00000-009
For DM20	0202-0117-00000-016



**l** Ring Set (Ø45~Ø75)



**m** Ring Set (Ø110~Ø130)



**n** Torque Wrench Adapter Socket



**o** Holding Fixture for adjusting clutches

# 1-Piece Wet-Type Diamond Core Bits (For models with 1-1/4"-7 UNC spindles)

450mm Length (1-1/4"-7 UNC Coupling) (Reinforced Concrete)			
Diameter (mm)	Segment Dimensions (mm)		Part Number
	Height x Thickness & Number of Segments		
25	H 9 x T 3.2 - single seg.		305-03356-004-034
32	H 9 x T 3.2 - single seg.		305-03356-004-035
38	H 9 x T 3.2 - single seg.		305-03356-004-036
42	H 9 x T 3.2 - single seg.		305-03356-004-037
52	H 10 x T 3.5 - 5 seg.		305-03356-004-038
56	H 10 x T 3.5 - 5 seg.		305-03356-004-039
62	H 10 x T 3.5 - 5 seg.		305-03356-004-040
65	H 10 x T 3.5 - 6 seg.		305-03356-004-041
72	H 10 x T 3.5 - 6 seg.		305-03356-004-042
76	H 10 x T 3.5 - 7 seg.		305-03356-004-043
82	H 10 x T 3.5 - 7 seg.		305-03356-004-044
86	H 10 x T 3.5 - 7 seg.		305-03356-004-045
92	H 10 x T 3.5 - 8 seg.		305-03356-004-046
102	H 10 x T 3.5 - 9 seg.		305-03356-004-047
112	H 10 x T 3.5 - 10 seg.		305-03356-004-048
122	H 10 x T 3.5 - 10 seg.		305-03356-004-050
127	H 10 x T 3.5 - 10 seg.		305-03356-004-051
132	H 10 x T 3.5 - 10 seg.		305-03356-004-052
142	H 10 x T 3.5 - 11 seg.		305-03356-004-053
152	H 10 x T 4.0 - 12 seg.		305-03356-004-054
162	H 10 x T 4.0 - 12 seg.		305-03356-004-055
172	H 10 x T 4.0 - 13 seg.		305-03356-004-056
182	H 10 x T 4.0 - 13 seg.		305-03356-004-057
200	H 10 x T 4.0 - 14 seg.		305-03356-004-058
203	H 10 x T 4.0 - 14 seg.		305-03356-004-059
226	H 10 x T 4.5 - 15 seg.		305-03356-004-060
232	H 10 x T 4.5 - 16 seg.		305-03356-004-061
252	H 10 x T 4.5 - 16 seg.		305-03356-004-062
300	H 10 x T 5.0 - 20 seg.		305-03356-004-063
305	H 10 x T 5.0 - 20 seg.		305-03356-004-064
332	H 10 x T 5.0 - 22 seg.		305-03356-004-065
356	H 10 x T 5.0 - 24 seg.		305-03356-004-066
<b>Special Core Bit for Asphalt:</b>			
102	H 10 x T 4.0 - 9 seg.	305-03356-004-067	



# S170 / AS200 / NS250 / S350 / S500 / S800 Diamond Core Drill Stands

**S800**

Aluminum column with steel inserts for maximum rigidity and minimum weight

Convenient, tool-free carriage lock lever

Quick mount Dovetail cradle for fast motor fixing

Motor Mounting Plate supplied as standard equipment:

NS250 & S350      S500 & S800

Crank Handle doubles as a wrench

Heavy gauge steel base with lightening holes for optimum stability and vibration resistance

AS200 folds down completely for easy storage

S800 and S500 include a second crank spindle with reduction gearing for decreased effort

Optional: Fixing Kit for use with M12 drop-in anchors: Includes stud, washer, and speed nut (drop-in anchors not included)

Optional: Anchoring Plate (necessary with steel-base models: AS200, S170, NS250, S350, S500, S800)

Wheels for easy transport

0~45°



Model	S170	AS200	NS250	S350	S500	S800
Capacity w/o extension spacers (mm)	Ø170 (7")	Ø202 (8")	Ø250 (10")	Ø350 (14")	Ø350 (14")	Ø400 (16")
Max. Capacity with extension spacers (mm)	-	-	-	-	Ø500 (20")	Ø800 (32")
Effective Stroke (mm)	540	590	660	660	690	760
Dimensions (LxWxH) (mm)	460 x 215 x 815	361 x 250 x 890	400 x 245 x 984	390 x 248 x 970	480 x 240 x 1025	555 x 275 x 1035
Weight (Not Including crank handle)	10.1 kg (22.3 lb)	10.5 kg (23.1 lb)	14.9 kg (31.7 lb)	14.4 kg (31.7 lb)	19.1 kg (42.0 lb)	26.5 kg (58.4 lb)

# QS600 Diamond Core Drill Stand

**Large Capacity**  
Fits up to 500 mm bits without needing to use any extension spacer.

**Optional:**  
50 mm Extension Spacer Kit allows drilling up to Ø 600 mm



**Wrench Stop Lug**  
For safely loosening tight core bits



**Quick-Release Cam-Lock Cradle**  
Makes it easy to mount and remove the motor, even in difficult positions.



**Dual Gear Ratio Feed on Both Sides**  
One ratio for fast motion, and the other slow ratio for decreased operator effort



**Self-Centering M19 Crank Handle**  
Gives more leverage when extended and is convenient to use as a wrench for all of the M19 control elements.



**Convenient Features**  
Pin-type carriage lock  
Built-In horizontal & vertical spirit levels  
Cable clip

Model	QS600
Capacity w/o extension spacers (mm)	Ø500 (20")
Max. Capacity with extension spacers (mm)	Ø600 (24")
Effective Stroke (mm)	670
Dimensions (LxWxH) (mm)	582 x 313 x 1032
Weight (Not Including crank handle)	26.8 kg (59 lb)

# Diamond Core Drill Stand Accessories

## ■ Laser Aiming Devices

Especially useful when creating accurately aligned holes through multiple walls for pipe passes.



**f** Anchoring Plate

**g** Fixing Kit

**l** AS200 Water Collector Set (includes 3 membranes) Size Range: 20 - 162 mm

Replacement membranes (5 pack)

Related Product:  
Vacuum Cleaner DE25 (see p. 96)

Vacuum Pump VP140 (see p. 65)

**m** VB400 Vacuum Base:  
Fits S170, AS200, NS250, S350, S500, QS600

Vacuum Hose

Vacuum Tank

Dovetail Type  
Extension Spacers

**a** 200 mm

**b** 150 mm

**c** 100 mm

**d** 45 mm

**e** 50 mm

**h** Jack Screw

**i** Front Handle Set

**n** 60 mm Clamp Bracket

Optional Accessories	Part Number
<b>a</b> Extension Spacer 200 mm (S800: 800 mm)	0299-0159-00000-004
<b>b</b> Extension Spacer 150 mm (S800: 700 mm)	0299-0159-00000-003
<b>c</b> Extension Spacer 100 mm (S500: 500 mm / S800: 600 mm)	0299-0159-00000-002
<b>d</b> Extension Spacer 45 mm (S500: 450 mm / S800: 500 mm)	0299-0159-00000-001
<b>e</b> Extension Spacer Kit 50 mm (QS600: 600 mm)	0299-0333-00000-001
<b>f</b> Anchoring Plate	302-04464-903-001
<b>g</b> Fixing Kit	0299-0252-0000-001
<b>h</b> Jack Screw (M16)	302-04178-907-001
<b>h</b> Jack Screw (M20)	302-04178-907-003
<b>i</b> Front Handle Set for S500	0299-0211-0000-001
<b>j</b> Laser Aiming Device 1-1/4" & 60 mm	0299-0261-00000-001
<b>k</b> Laser Aiming Device 1/2" BSP	0299-0261-00000-002
<b>l</b> AS200 Water Collector Set (includes 3 membranes) Size Range: 20 - 162 mm	0299-0249-0004-001
Replacement membranes (5 pack)	0299-0250-0004-001
<b>m</b> VB400 Vacuum Plate (Fits S170, AS200, NS250, S350, S500, QS600)	0299-0143-00000-028
<b>n</b> 60 mm Clamp Bracket, All Models (except S170, AS200)	0299-0159-00000-005

# Diamond Core Drill Stand Accessories

## S170 Diamond Core Drill Stand

Standard Accessories	
Crank Handle	
Clamp Bracket	
Optional Accessories	Part Number
<b>f</b> Anchoring Plate	302-04464-903-001
<b>g</b> Fixing Kit	0299-0252-0000-001
<b>j</b> Laser Aiming Device 1-1/4" & 60 mm	0299-0261-00000-001
<b>k</b> Laser Aiming Device 1/2" BSP	0299-0261-00000-002
<b>m</b> VB400 Vacuum Plate	0299-0143-00000-028



**f** Anchoring Plate



**g** Fixing Kit

## AS200 Diamond Core Drill Stand

Standard Accessories	
Crank Handle	
Clamp Bracket	
Optional Accessories	Part Number
<b>f</b> Anchoring Plate	302-04464-903-001
<b>g</b> Fixing Kit	0299-0252-0000-001
<b>h</b> Jack Screw (M16)	302-04178-907-001
<b>j</b> Laser Aiming Device 1-1/4" & 60 mm	0299-0261-00000-001
<b>k</b> Laser Aiming Device 1/2" BSP	0299-0261-00000-002
<b>l</b> AS200 Water Collector Set (includes 3 membranes) Size Range: 20 - 162 mm	0299-0249-0004-001
<b>m</b> VB400 Vacuum Plate	0299-0143-00000-028



**h** Jack Screw



**j** Laser Aiming Device  
1-1/4" & 60 mm

## NS250 Diamond Core Drill Stand

Standard Accessories	
Crank Handle	
Motor Mount	
Optional Accessories	Part Number
<b>f</b> Anchoring Plate	302-04464-903-001
<b>g</b> Fixing Kit	0299-0252-0000-001
<b>h</b> Jack Screw (M16)	302-04178-907-001
<b>j</b> Laser Aiming Device 1-1/4" & 60 mm	0299-0261-00000-001
<b>k</b> Laser Aiming Device 1/2" BSP	0299-0261-00000-002
<b>m</b> VB400 Vacuum Plate	0299-0143-00000-028
<b>n</b> 60 mm Clamp Bracket	0299-0159-00000-005



**k** Laser Aiming Device  
1/2" BSP



**l** AS200 Water Collector  
Set

## S350 Diamond Core Drill Stand

Standard Accessories	
Crank Handle	
Motor Mount	
Optional Accessories	Part Number
<b>f</b> Anchoring Plate	302-04464-903-001
<b>g</b> Fixing Kit	0299-0252-0000-001
<b>h</b> Jack Screw (M16)	302-04178-907-001
<b>j</b> Laser Aiming Device 1-1/4" & 60 mm	0299-0261-00000-001
<b>k</b> Laser Aiming Device 1/2" BSP	0299-0261-00000-002
<b>m</b> VB400 Vacuum Plate	0299-0143-00000-028
<b>n</b> 60 mm Clamp Bracket	0299-0159-00000-005



**m** VB400 Vacuum Plate



**n** 60 mm Clamp Bracket

# Diamond Core Drill Stand Accessories

## S500 Diamond Core Drill Stand

Standard Accessories	
	Crank Handle
	Motor Mount
Optional Accessories	Part Number
<b>c</b> Extension Spacer 100 mm (S500: 500 mm)	0299-0159-00000-002
<b>d</b> Extension Spacer 45 mm (S500: 450 mm)	0299-0159-00000-001
<b>f</b> Anchoring Plate	302-04464-903-001
<b>g</b> Fixing Kit	0299-0252-0000-001
<b>h</b> Jack Screw (M16)	302-04178-907-001
<b>i</b> Front Handle Set for S500	0299-0211-0000-001
<b>j</b> Laser Aiming Device 1-1/4" & 60 mm	0299-0261-00000-001
<b>k</b> Laser Aiming Device 1/2" BSP	0299-0261-00000-002
<b>m</b> VB400 Vacuum Plate	0299-0143-00000-028
<b>n</b> 60 mm Clamp Bracket	0299-0159-00000-005

### Dovetail Type Extension Spacers

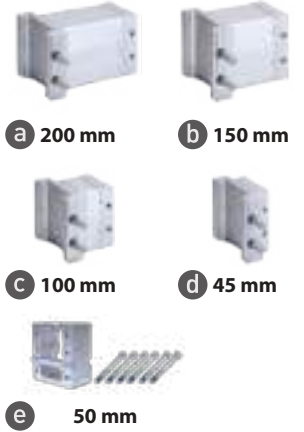

## S800 Diamond Core Drill Stand

Standard Accessories	
	Crank Handle
	Motor Mount
Optional Accessories	Part Number
<b>a</b> Extension Spacer 200 mm (S800: 800 mm)	0299-0159-00000-004
<b>b</b> Extension Spacer 150 mm (S800: 700 mm)	0299-0159-00000-003
<b>c</b> Extension Spacer 100 mm (S800: 600 mm)	0299-0159-00000-002
<b>d</b> Extension Spacer 45 mm (S800: 500 mm)	0299-0159-00000-001
<b>f</b> Anchoring Plate	302-04464-903-001
<b>g</b> Fixing Kit	0299-0252-0000-001
<b>h</b> Jack Screw (M20)	302-04178-907-003
<b>j</b> Laser Aiming Device 1-1/4" & 60 mm	0299-0261-00000-001
<b>k</b> Laser Aiming Device 1/2" BSP	0299-0261-00000-002
<b>n</b> 60 mm Clamp Bracket	0299-0159-00000-005

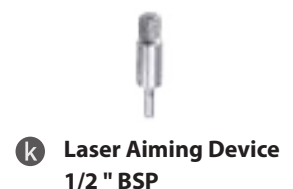

## QS600 Diamond Core Drill Stand

Standard Accessories	
	Crank Handle
	Motor Mount
Optional Accessories	Part Number
<b>e</b> Extension Spacer Kit 50 mm (QS600: 600 mm)	0299-0333-00000-001
<b>f</b> Anchoring Plate	302-04464-903-001
<b>g</b> Fixing Kit	0299-0252-0000-001
<b>h</b> Jack Screw (M16)	302-04178-907-001
<b>j</b> Laser Aiming Device 1-1/4" & 60 mm	0299-0261-00000-001
<b>k</b> Laser Aiming Device 1/2" BSP	0299-0261-00000-002
<b>m</b> VB400 Vacuum Plate	0299-0143-00000-028
<b>n</b> 60 mm Clamp Bracket	0299-0159-00000-005



# VP140 VACUUM PUMP

A vacuum pump specifically designed for use with power tools which are anchored by a vacuum base.



4 Air Hose, 2.5 M

VP140 Vacuum Pump

7 Vacuum Tank

VB400 Vacuum Base  
See p. 64

Mag Drill Vacuum Base  
See p. 117

## Features

1. Integrated Switching Socket only supplies power to tool when sufficient vacuum is achieved.
2. Warning Buzzer sounds when vacuum is insufficient.
3. Vacuum Gauge alerts operator to vacuum status.
4. Quick-Release Fittings for faster set up.
5. Water Separator for draining out water from the system.
6. Safety Reset Button to energize the connected power tool.
7. Optional Vacuum Tank provides an added layer of safety.

Model	VP140
Power Input	200 W
Voltage, Frequency	220-240 V~ 50-60 Hz or 110-120 V~ 50-60 Hz
Air Flow	30.5 l/min (1.07 cfm)
Max Vacuum	-0.9 bar (-13 psi)
Ingress Protection	IPX4
Dimensions (LxWxH)	310 x 238 x 250 mm
Weight	6.7 kg (14.8 lb)
Characteristics / Certification	<b>CE CB</b>

<b>Standard Accessories</b>
Air Hose, 2.5 M
<b>Optional Accessories</b>
Vacuum Tank (Includes Air Hose, 1 M)

# CONCRETE GRINDERS



BG5



BG125



G5



G125



G7



G180



Ø Diameter



125 mm



125 mm



125 mm



125 mm



180 mm



180 mm

Power

■ High Frequency Brushless Motor

■ Universal Motor



<b>MODEL / FEATURES</b>	<b>BG5</b>	<b>BG125</b>	<b>G5</b>	<b>G125</b>	<b>G7</b>	<b>G180</b>
<b>MOTOR TYPE</b>	High Frequency	High Frequency	Universal motor	Universal motor	Universal motor	Universal motor
<b>POWER</b>	2200 W	2200 W	2200 W	2000 W	2200 W	24 00 W
<b>WHEEL Ø</b>	125 mm	125 mm	125 mm	125 mm	180 mm	180 mm
<b>SPINDLE</b>	M14	M14	M14	M14	M14	M14
<b>ARBOR</b>	22.23 mm (7/8")	22.23 mm (7/8")	22.23 mm (7/8")	22.23 mm (7/8")	22.23 mm (7/8")	22.23 mm (7/8")
<b>SOFT START</b>	Yes	Yes	Yes	Yes	Yes	Yes
<b>OVERLOAD PROTECTION</b>	Yes	Yes	Yes	Yes	Yes	Yes
<b>THERMAL PROTECTION</b>	Yes	Yes	Yes	Yes	Yes	Yes
<b>ANTI-RESTART</b>	Yes	Yes	Yes	Yes	Yes	Yes
<b>CONSTANT SPEED</b>	Yes	Yes	Yes	Yes	Yes	Yes
<b>VARIABLE SPEED</b>	6 Speeds	6 Speeds	Variable Speed	Variable Speed	Variable Speed	Variable Speed
<b>LOAD WARNING LED</b>	Yes	Yes	No	Yes	No	Yes
<b>INGRESS PROTECTION</b>	IP55	IP55	not rated	not rated	not rated	not rated
<b>INSULATION CLASS</b>	Class II	Class II	Class II	Class II	Class II	Class II
<b>EDGE CUT-OUT</b>	Yes	Yes	Yes	Yes	Yes	Yes
<b>SPRING SUSPENSION SKIRT</b>	Yes	Yes	Yes	Yes	Yes	Yes
<b>WATER &amp; DUST RESISTANT SOLID-STATE SWITCH</b>	Yes	Yes	No	Yes	No	Yes
<b>ADJUSTABLE HANDLE</b>	No	Yes	No	Yes	No	Yes
<b>TROLLEY COMPATIBLE</b>	Yes	No	Yes	No	Yes	No

# G5 CONCRETE GRINDER

125 mm, high endurance concrete grinder with excellent dust control. Variable constant speed allows versatility and isolation handle mounts protect the operator from vibration. Vertical style design is especially good for grinding floors.



## Features

1. Constant speed is maintained regardless of load for an even finish.
2. Variable speed for different applications.
3. Tool-free sliding cover for edge grinding.
4. Effective dust control skirt with spring suspension and replaceable brush.
5. Anti-Vibration Handles isolate the operator from vibration.
6. Built-in lugs for mounting to the Floor Grinding Trolley.

**Standard/ Optional Accessories See p. 79**

Model	G5
Power Input	2200 W (220-240 V), 1700 W (110-120 V)
Voltage, Frequency	220-240 V~ 50-60 Hz or 110-120 V~ 50-60 Hz
*No Load Speeds	4500 - 9500 min <sup>-1</sup>
Wheel Diameter	125 mm (5")
Soft Start & Overload Protection	With
Arbor	22.23 mm (7/8")
Dimensions (LxWxH)	246 x 280 x 325 mm
Weight	5.7 kg (12.6 lb)
Characteristics / Certification	

**OPTIONAL ACCESSORIES:**



Floor Grinding Trolley

\* Due to the constant speed design, the no load and the rated load speeds are roughly the same.

# G7 CONCRETE GRINDER

180 mm, high endurance concrete grinder with excellent dust control. Variable constant speed allows versatility and isolation handle mounts protect the operator from vibration. Vertical style design is especially good for grinding floors.



## Features

1. Constant speed is maintained regardless of load for an even finish.
2. Variable speed for different applications.
3. Tool-free sliding cover for edge grinding.
4. Effective dust control skirt with spring suspension and replaceable brush.
5. Anti-Vibration Handles isolate the operator from vibration.
6. Built-in lugs for mounting to the Floor Grinding Trolley.

**Standard/ Optional Accessories See p. 79**

Model	G7
Power Input	2200 W (220-240V) , 1700 W (110-120 V)
Voltage, Frequency	220-240 V~ 50-60 Hz or 110-120 V~ 50-60 Hz
*No Load Speeds	3200 - 6500 min <sup>-1</sup>
Wheel Diameter	180 mm (7")
Soft Start & Overload Protection	With
Arbor	22.23 mm (7/8")
Dimensions (LxWxH)	246 x 280 x 325 mm
Weight	6.0 kg (13.2 lb)
Characteristics / Certification	

**OPTIONAL ACCESSORIES:**



Floor Grinding Trolley

\* Due to the constant speed design, the no load and the rated load speeds are roughly the same.

# G125 CONCRETE GRINDER

125 mm, compact and high endurance concrete grinder with excellent dust control. Variable constant speed allows versatility and the LED Load Indicator allows the operator to work at peak efficiency. Angle style design for general concrete grinding tasks.



## Features

1. Constant speed is maintained regardless of load for an even finish.
2. Variable speed for different applications.
3. LED Indicator for optimizing grinding efficiency with overload and overheat warning.
4. The dust and water resistant solid-state switch is more durable and reliable than traditional switches. The switch also features anti-restart function.
5. Adjustable ergonomic front handle allows clearance for edge grinding.
6. Effective dust control skirt with spring suspension and replaceable brush.
7. Tool-free sliding cover for edge grinding.

**Standard/ Optional Accessories See p. 79**

Model	G125
Power Input	2000 W (230-240 V), 1700 W (220 V), 1500 W (110-120 V)
Voltage, Frequency	230-240 V~ 50-60 Hz, 220 V~ 50-60 Hz or 110-120 V~ 50-60 Hz
*No Load Speeds	4300 - 7200 min <sup>-1</sup>
Wheel Diameter	125 mm (5")
Soft Start & Overload Protection	With
Arbor	22.23 mm (7/8")
Spindle	M14 or 5/8-11 (Specify when ordering)
Dimensions (LxWxH)	500 x 195 x 175 mm
Weight	4.7 kg (10.3 lb)
Characteristics / Certification	

\* Due to the constant speed design, the no load and the rated load speeds are roughly the same.

# G180 CONCRETE GRINDER

180 mm high endurance concrete grinder with excellent dust control. Variable constant speed allows versatility and the LED Load Indicator allows the operator to work at peak efficiency. Angle style design for general concrete grinding tasks.



## Features

1. Constant speed is maintained regardless of load for an even finish.
2. Variable speed for different applications.
3. LED Indicator for optimizing grinding efficiency with overload and overheat warning.
4. The dust and water resistant solid-state switch is more durable and reliable than traditional switches. The switch also features anti-restart function
5. Adjustable ergonomic front handle allows clearance for edge grinding.
6. Effective dust control skirt with spring suspension and replaceable brush.
7. Tool-free sliding cover for edge grinding.

**Standard/ Optional Accessories See p. 79**

Model	G180
Power Input	2300 W (220-240 V), 2100 W (110-120 V)
Voltage, Frequency	230-240 V~ 50-60 Hz, 110-220 V~ 50-60 Hz
*No Load Speeds	3500 - 5800 min <sup>-1</sup>
Wheel Diameter	180 mm (7")
Soft Start & Overload Protection	With
Arbor	22.23 mm (7/8")
Spindle	M14 or 5/8-11 (Specify when ordering)
Dimensions (LxWxH)	540 x 210 x 195 mm
Weight	5.6 kg (12.3 lb)
Characteristics / Certification	

\* Due to the constant speed design, the no load and the rated load speeds are roughly the same.

# BG125 HIGH FREQUENCY BRUSHLESS CONCRETE GRINDER & P4K POWER CONVERTER

Angle style 125 mm concrete grinder with super-efficient, high frequency PMSM brushless motor for high performance, long life and long duty cycles. Angle style design is suitable for a wide range of concrete grinding tasks.



**P4K**



P4K Details See p. 76

This grinder requires the P4K power converter to operate.

**Features**

1. Constant speed is maintained regardless of load for an even finish.
2. LED Indicator for optimizing grinding efficiency with overload and overheat warning.
3. IP55 waterproof and dustproof construction makes it ideal for grinding hazardous materials.
4. Tool-free sliding cover for edge grinding.
5. Effective dust control skirt with spring suspension and replaceable brush.
6. Adjustable ergonomic front handle allows clearance for edge grinding.
7. The dust and water resistant solid-state switch is more durable and reliable than traditional switches. The switch also features anti-restart function.

**Standard/ Optional Accessories See p. 79**

Model	BG125
Power Input	2200 W
*No Load Speeds	3550 - 5350 min <sup>-1</sup>
Wheel Diameter	125 mm (5")
Soft Start & Overload Protection	With
Arbor	22.23 mm (7/8")
Spindle	M14 or 5/8-11 (Specify when ordering)
Ingress Protection	IP55
Dimensions (LxWxH)	455 x 200 x 175 mm
Weight	4.6 kg (10.1 lb)
Characteristics / Certification	



\* Due to the constant speed design, the no load and the rated load speeds are roughly the same.

# BG5 HIGH FREQUENCY BRUSHLESS CONCRETE GRINDER & P4K POWER CONVERTER

125 mm concrete grinder with super-efficient, high frequency PMSM brushless motor for high performance, long life and long duty cycles. Vertical style design is especially good for grinding floors and the isolation handle mounts protect the operator from vibration.



■ P4K



P4K Details See p. 76

This grinder requires the P4K power converter to operate.

## Features

1. Constant speed is maintained regardless of load for an even finish.
2. LED Indicator for optimizing grinding efficiency with overload and overheat warning.
3. IP55 waterproof and dustproof construction makes it ideal for grinding hazardous materials.
4. Tool-free sliding cover for edge grinding.
5. The dust and water resistant solid-state switch is more durable and reliable than traditional switches. The switch also features anti-restart function.
6. Effective dust control skirt with spring suspension and replaceable brush.
7. Anti-vibration handle mounts for fatigue free operation.
8. Built-in lugs for mounting to the Floor Grinding Trolley.

**Standard/ Optional Accessories See p. 79**

Model	BG5
Power Input	2200 W
*No Load Speeds	3850 - 5800 min <sup>-1</sup>
Wheel Diameter	125 mm (5")
Soft Start & Overload Protection	With
Arbor	22.23 mm (7/8")
Spindle	M14 or 5/8-11 (Specify when ordering)
Ingress Protection	IP55
Dimensions (LxWxH)	235 x 290 x 235 mm
Weight	5.1 kg (11.3 lb)
Characteristics / Certification	

■ OPTIONAL ACCESSORIES:



Floor Grinding Trolley

\* Due to the constant speed design, the no load and the rated load speeds are roughly the same.

# Versatile Grinding For Professional Results



## Grinding Surfaces

For consistent, smooth and even surfaces, BG grinders are ideal for stripping epoxy or urethane resin coatings using PCD wheels. Hard concrete surfaces, whether it be walls floors or ceilings, can be comfortably and efficiently ground using soft bond diamond cup wheels.



## Profiling Surfaces

Ideal for grinding screed and tile adhesive using hard-bond diamond cup wheels. Attractive finishes can be achieved on concrete, stone or marble surfaces using the 7 adjustable speed settings of the BG5 and BG125.



## IP55 Ingress Protection

Protects both the BG5 and BG125 from water and dust ingress. Both grinders can be thoroughly washed, withstanding low pressure water jets, making them ideal for working with hazardous materials such as asbestos.

## Higher Reliability

High endurance motors for longer service life.

## Dust-resistant

Uniquely designed to prevent dust ingress.

## Higher Productivity

More efficient PMSM motor, reducing standard grinding time, saving effort and money.

## Adjustable speed

Adapt the speed to the needs of the work material.

## Clog-resistant

Grinds thinly coated materials without clogging the motor.



# Features

---



## Edge Grinding

Both models have a tool-free sliding cover, allowing users to effortlessly switch between normal and edge grinding operations.



## LED Indicator

The LED indicator helps operators to optimize downward force, improving grinding efficiency by indicating normal load, maximum or exceeded full load. It also displays overheat warning for added safety.

## Uniquely Designed For **Maximum Output**



## Innovative Dust Skirt

Innovative and effective dust skirt is held in place with automatic spring suspension, adapting to any surface.



## Anti-Vibration Mounting

Operators can use the grinders for extended periods due to the anti-vibration mounting design.



## Adjustable Handle

The G125, G180, BG125 models come equipped with an adjustable handle allowing extra clearance for edge grinding, thus improving ergonomics and operator comfort.



## P4K POWER CONVERTER

Air cooled 4500 W power converter with special circuitry which allows it to accept a **full range of single phase supply voltages from 100 V up to 240 V** at the maximum possible power level.

1. Converter can preset various speeds for different applications.
2. 4500 W power converter with special circuitry which allows it to accept single phase 100 V to 240 V and converts it to 3 phase, high frequency to control the motor.
3. Converter with built-in PRCD has full electronic protection for over and under voltage, thermal and current overload.
4. LCD Information Display shows voltage, error codes, and elapsed hours.



Model	P4K
Voltage	100 V-240 V~ 50-60 Hz
Max. Power Input	1φ 4500 W
Max. Power Output	3φ 4.0 kW
Ingress Protection	IP55
Weight	3.1 kg (6.9 lb)



**Application: BG125, BG5**

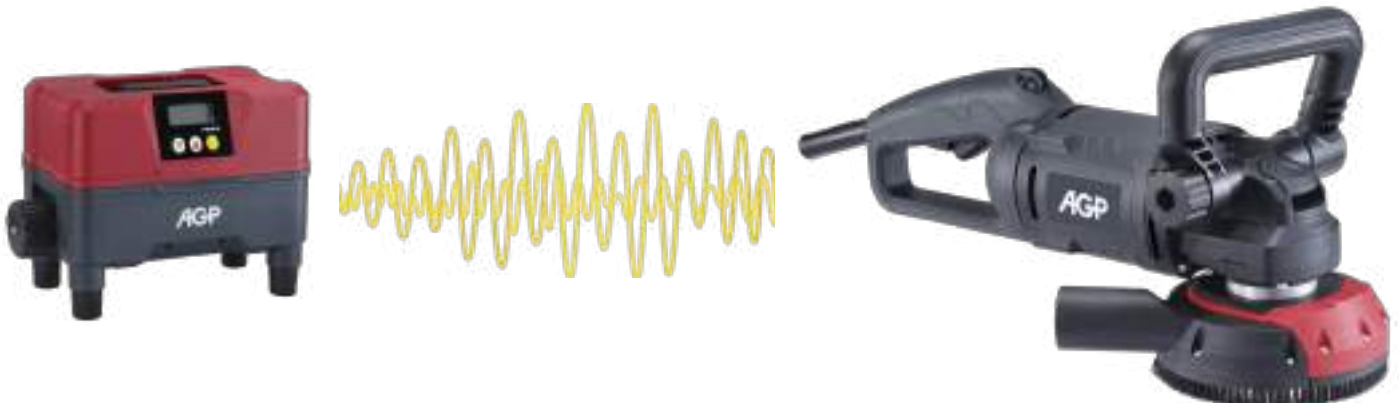

# Grinding Accessories

## BG125 High Frequency Brushless Concrete Grinder

Standard Accessories	
Lock Nut Wrench	
Face Spanner Wrench	
Hex Key M6	
Optional Accessories	
Various Grits of Diamond Cup Wheel	

## BG5 High Frequency Brushless Concrete Grinder

Standard Accessories	
Lock Nut Wrench	
Face Spanner Wrench	
Hex Key M6	
Optional Accessories	
<b>a</b> Floor Grinding Trolley	
Various Grits of Diamond Cup Wheel	



**a** Floor Grinding Trolley

## G5 Concrete Grinder

Standard Accessories	
Lock Nut Wrench	
Face Spanner Wrench	
Hex Key M6	
Optional Accessories	
<b>a</b> Floor Grinding Trolley	
Various Grits of Diamond Cup Wheel	

## G7 Concrete Grinder

Standard Accessories	
Lock Nut Wrench	
Face Spanner Wrench	
M6 Hex Key	
Optional Accessories	
<b>a</b> Floor Grinding Trolley	
Various Grits of Diamond Cup Wheel	

## G125 Concrete Grinder

Standard Accessories	
Lock Nut Wrench	
Face Spanner Wrench	
Optional Accessories	
Various Grits of Diamond Cup Wheel	

## G180 Concrete Grinder

Standard Accessories	
Lock Nut Wrench	
Face Spanner Wrench	
Optional Accessories	
Various Grits of Diamond Cup Wheel	

# LG125 LONG-REACH CONCRETE GRINDER

125 mm long reach grinder for grinding and polishing concrete. A unique tool which allows the operator to grind walls, ceilings, and other hard-to-reach areas with unprecedented ease, while collecting the dust at the same time.



## Features

1. Versatility with variable speed adjustment.
2. Motor with soft start & constant speed electronics.
3. Swiveling Bayonet Hose Connector for convenient dust collection.
4. 2-Axis Pivoting Grinding Head with Dust Shroud easy to guide smoothly over the work surface.
5. Soft Grip on column for operator comfort.

**Standard/ Optional Accessories See p. 81**

Model	LG125			
Power Input	1200 W	Arbor	22.23 mm (7/8") or 25.4 mm (1")	
Voltage, Frequency	220-240 V~ 50-60 Hz or	Length	1475 mm	
	110-120 V~ 50-60 Hz	Max. Capacity	125 mm	
*No Load Speeds	1700 - 3500 min <sup>-1</sup>	Spindle	M14 or 5/8 -11	
Dimensions (LxWxH)	1475 x 197 x 365 mm		Soft Start & Overload Protection	With
Weight	3.8 kg (8.4 lb) ( Not including Diamond Cup Wheel)	Characteristics / Certification		

\* Due to the constant speed design, the no load and the rated load speeds are roughly the same.

## LG125 Long-Reach Concrete Grinder

Standard Accessories		
<b>a</b>	Face Spanner Wrench, 78 mm	
	Carry Bag	
	Bail Handle	
<b>b</b>	Vacuum Hose 4 M	
	M17 Wrench	
	Hex Key M6	
<b>d</b>	125 mm Diamond Cup Wheel	
Optional Accessories		
	Part Number	
<b>c</b>	Aluminum Backing Pad (M14)	201-0045-00906-001
	Aluminum Backing Pad (5/8")	201-0045-00906-002



**a** Face Spanner Wrench



**b** Vacuum Hose 4m



**c** Aluminum Backing Pad



**d** Diamond Cup Wheel

## Diamond Cup Wheels

125 mm (5") For G5, G125, BG5, BG125, LG125	Part Number
#60/80 Grit 22.2 mm (7/8") bore	305-00072-000-018
#100/120 Grit 22.2 mm (7/8") bore	305-00072-000-020
180 mm (7") For G7, G180	Part Number
With 22.2 mm (7/8") bore	305-00072-000-011
With 25.4 mm (1") bore	305-00072-000-013
With Female Thread M14	305-00072-000-012

## CG125 WALL CHASER

A light and convenient wall chaser with a maximum depth of 40 mm and cutting width up to 35 mm. Features outstanding dust control.



## CG150 WALL CHASER

A powerful wall chaser specially designed for dust control with a maximum depth of 50 mm and cutting width up to 45 mm. Can run 5 blades for chasing in one step, with virtually no chiseling required afterwards. Features an optional efficient guide rail system.





Optional quick set-up Guide Rail System provides maximum operator convenience and minimizes human error.

Guide rail support Set

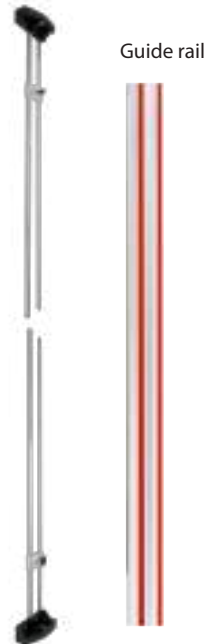

2 blades

5 blades



**Features**

1. Smart Electronic Control for constant speed, soft start, overload and thermal protection.
2. LED load indicator indicates load conditions.
3. Multi-location wheels for constant support over irregular surfaces.
4. Large switch for holding in various positions.
5. Adjustable cutting depth limiter.
6. Quick-opening blade guard and tool-free arbor screw for fast and easy blade changes.
7. The dust and water resistant solid-state switch is more durable and reliable than traditional switches.
8. Built in laser helps operator to produce a straight cut each time. (CG150)
9. Includes spacers for both 2 and 5 blade chasing. (CG150)
10. Tool free blade changes.

**Standard/ Optional Accessories See p. 86**

Model	CG125		
Power Input	1800 W (220 V), 1700 W (110 V)	Depth of Cut control system	With
Voltage, Frequency	220-240 V~ 50-60 Hz or 110-120 V~ 50-60 Hz	Rotatable dust collection system	With
*No Load Speed	9000 min <sup>-1</sup>	Soft Start / Overload Protection	With
Max. Blade Diameter	Ø125 mm	Thermal Protection	With
Max Depth of Cut	40 mm	Constant Speed	With
Max Channel Width	35 mm		
Dimensions (LxWxH)	365 x 151 x 247 mm	Characteristics / Certification	
Weight	4.7 kg (10.4 lb)		

Model	CG150		
Power Input	2500 W (220 V), 2300 W (110 V)	Cut to Ceiling	25 mm
Voltage, Frequency	220-240 V~ 50-60 Hz or 110-120 V~ 50-60 Hz	Cut to Edge	28 mm
*No Load Speed	6500 min <sup>-1</sup>	Blade bore size	22.23 mm (7/8")
Max. Blade Diameter	Ø150 mm	Soft Start / Overload Protection	With
Max Depth of Cut	50 mm	Thermal Protection	With
Max Channel Width	45 mm	Constant Speed	With
Dimensions (LxWxH)	365 x 220 x 288 mm	Characteristics / Certification	
Weight	7.2 kg (15.8 lb)		

\* Due to the constant speed design, the no load and the rated load speeds are roughly the same.

# CS125N WALL CHASER

125 mm wall chaser with 30 mm depth of cut and 45 mm maximum channel width. Clockwise blade rotation. 1500 W motor with constant speed electronics for consistent performance.

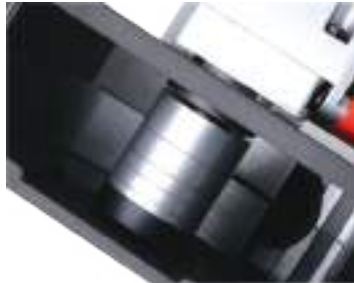

## Features

1. 1500 W motor with electronic constant speed, soft start, and overload protection.
2. Vacuum Port Swivels 360°.
3. Ergonomic handle in line with the blades for control.
4. Steel Rollers for durability.
5. Adjustable depth of cut for precise channel dimensions.
6. Pivoting safety cover for dust control and safety.

**Standard/ Optional Accessories See p. 86**

Model	CS125N		
Power Input	1500 W	Blade Bore	22.23 mm (7/8") or 30 mm
Voltage, Frequency	220-240 V~ 50-60 Hz or 110-120 V~ 50-60 Hz	Soft Start / Overload Protection	With
*No Load Speed	6500 min <sup>-1</sup>	Channel Width	18-45 mm
Max. Blade Diameter	125 mm	Dimensions (LxWxH)	378 x 221 x 196 mm
Max. Cutting Depth	30 mm	Weight	4.4 kg (9.7 lb)

Characteristics / Certification     
Only 220 V    Only 220 V

\* Due to the constant speed design, the no load and the rated load speeds are roughly the same.

# CS180 WALL CHASER

A 180 mm wall chaser with 52 mm depth of cut and 51 mm maximum channel width. 1800 W motor with overload protection.



## Features

1. 1800 W motor with smart electronic overload and externally accessible brushes.
2. Dust shroud gives extra dust protection at the beginning of the cut.
3. Sighting Notches.
4. Rollers for smooth cutting action.
5. Depth Scale.

**Standard/ Optional Accessories See p. 86**

Model	CS180		
Power Input	1800 W	Channel Width	9~51mm
Voltage, Frequency	220-240 V~ 50-60 Hz or 110-120 V~ 50-60 Hz	Soft Start / Overload Protection	With
No Load Speed	4100 min <sup>-1</sup>	Dimensions (LxWxH)	410 x 317 x 267 mm
Max. Blade Diameter	180 mm (7")	Weight	7.7 kg (16.9 lb)
Max. Cutting Depth	15~52 mm		

Characteristics / Certification



# Wall Chaser Accessories

## CG125 Wall Chaser

Standard Accessories	Part Number
Spacer Set	
Side Handle	
<b>a</b> 125 mm Diamond Saw Blade (Universal)	305-00036-000-081
<b>f</b> Blow Molded Case	



**a** Diamond Saw Blade (Universal)

## CG150 Wall Chaser

Standard Accessories	Part Number
Spacer Set (for 2-blade & 5-blade chasing)	
Chisel	
<b>a</b> 150 mm Diamond Saw Blade (Universal)	305-00036-000-068
<b>f</b> Blow Molded Case	
Optional Accessories	Part Number
<b>b</b> 150 mm Diamond Saw Blade (Hard Material)	305-00036-000-069
<b>c</b> Guide Rail (1400 mm)	0299-0065-00149-021
<b>d</b> Guide Rail Support Set	0299-0246-0000-003



**b** Diamond Saw Blade (Hard Material)

## CS125N Wall Chaser

Standard Accessories	Part Number
Side Handle	
4 mm T-Handle Hex Wrench	
Vacuum Hose End Adaptor	
6 mm L-Hex Wrench	
<b>e</b> Spacer Set	
Blow Molded Case	
Optional Accessories	Part Number
125 mm Diamond Blade	305-00036-000-051



**c** Guide Rail (1400 mm)



**d** Guide Rail Support Set



**e** Spacers

## CS180 Wall Chaser

Standard Accessories	Part Number
Side handle	
Hex. Wrench M10	
Vacuum Hose End Adaptor	
<b>e</b> Spacer Set	
Plastic Carry Case	
Optional Accessories	Part Number
Wall Chaser Diamond Blades ( each machine requires 2 pcs ) <b>Diameter:</b> 180 mm <b>Thickness:</b> 1.6 mm <b>Arbor:</b> 22.23 mm (7/8")	305-00036-000-007



**f** Blow Molded Case for CG125, CG150

# HS225 HAND-HELD DRYWALL SANDER

1200 W sander uses 225 mm (10") mesh sanding discs for clog-free sanding.



5 Dust Hood with Half-Moon Door



7 Bayonet Adaptor End

## Features

1. 1200 W motor with variable electronic constant speed control.
2. Designed to work with hook & loop sanding mesh discs for truly dust-free and clog-free sanding.
3. Speed Control Thumb Wheel for adjusting to suit various materials and grits.
4. Effective dust collection system with swiveling bayonet mount.
5. Dust Hood with Half-Moon Door to sand into corners.
6. Ergonomic Bail Handle.
7. Bayonet Adaptor End.

**Standard/ Optional Accessories See p. 91**

Model	HS225		
Power Input	1200 W	Soft Start	With
Voltage, Frequency	220-240 V~ 50-60 Hz or 110-120 V~ 50-60 Hz	Dimensions (LxWxH)	515 x 258 x 214 mm
*No Load Speeds	650 - 1300 min <sup>-1</sup>	Weight	3.0 kg (6.6 lb)
Sanding Disc Diameter	225 mm		
Characteristics / Certification			

\* Due to the constant speed design, the no load and the rated load speeds are roughly the same.

# SB9 HIGH FREQUENCY BRUSHLESS DRYWALL SANDER

Ultra-light, super-efficiency, 225 mm drywall sander for maximizing productivity with minimum fatigue. Maintenance-free design. Corded brushless high frequency motor for outstanding performance.



## Features

1. Ultra High Efficiency Brushless High Frequency Motor for unprecedented lightness.
2. Constant Speed Electronics for an even finish.
3. Direct drive motor does not need a flex shaft, making it maintenance free.
4. Speed adjusts to suit conditions for best sanding results.
5. Swiveling Bayonet Hose Coupling for freedom of movement.
6. Digital LED Information Display indicates speeds, elapsed hours, and error codes .
7. Built-In Half-Moon Door for edge sanding and Edge Cut-Out is fully adjustable to any angle needed.
8. Integrated Converter allows a wide range of voltages, and even performs well when using long extension cords.

**Standard/ Optional Accessories See p. 91**

Model	SB9		
Power Input	450 W	Soft Start / Overload Protection	With
*Voltage, Frequency	220-240 V~ 50-60 Hz or 110-120 V~ 50-60 Hz	Dimensions (LxWxH)	1430 x 254 x 157 mm
**No Load Speeds	1000 - 1600 min <sup>-1</sup>	Weight	2.8 kg (6.2 lb)
Sanding Disc Diameter	Ø 225 mm (8-7/8")	Insulation Class	Class I
Characteristics / Certification			

\* Due to the special electronics design, any voltage from 100 V to 250 V can be used with this tool.

\*\* Due to the constant speed design, the no load and the rated load speeds are roughly the same.

# The Lightest In The World. Greater Productivity With Ease.



SB9 Introduction Video



AGP SB9



# GS9FE & GS9FSE DRYWALL SANDER

A light-weight and balanced sander, with pivoting sanding head and effective dust control, The long-reach design allows easy sanding of walls and ceilings.



5



Hose Protector (optional)



Vacuum Hose 4 M w/ Bayonet Adaptor

## Features

1. Bail Handle for effective control.
2. Sponge Grip on column and Soft Grip on main handle for comfort.
3. Speed Adjustment to suit various materials and sanding grits.
4. Swiveling Bayonet Hose Connector allows freedom of movement.
5. Optional Hose Protector prevents hose from being crushed.

**Standard/ Optional Accessories See p. 91**

Model	GS9FSE	GS9FE
Power Input	550 W	
Voltage, Frequency	220-240 V~ 50-60 Hz or 110-120 V~ 50-60 Hz	
No Load Speeds	650 - 1600 min <sup>-1</sup>	
Rated Load Speeds	280 - 950 min <sup>-1</sup>	
Grinding Disc	Ø 225 mm (8-7/8")	
Soft Start	With	
Dimensions (LxWxH)	1090 x 260 x 310 mm	1540 x 260 x 350 mm
Weight	3.8 kg (8.4 lb)	4.7 kg (10.4 lb)
Characteristics / Certification		

# Drywall Sander Accessories

## HS225 Hand-Held Drywall Sander

Standard Accessories	
a1	Hook & Loop Sponge Backing Pad
	Bayonet Adaptor End (for connecting to your vacuum hose)
	Plastic Carry Case
Optional Accessories	Part Number
b	Vacuum Hose 4M w/ Bayonet Adaptor 0203-0007-00004-004
f	225 mm Mesh Dustless Sanding Discs - various grits 0203-0007-00004-004



a1 Hook & Loop Sponge Backing Pad



a2 Hook & Loop Sponge Backing Pad



b Vacuum Hose w/ Bayonet Adaptor

## SB9 Brushless Drywall Sander

Standard Accessories	
a2	Hook & Loop Sponge Backing Pad
g	Carry Bag
Optional Accessories	Part Number
f	225 mm Mesh Dustless Sanding Discs - various grits
h	540 mm Extension Bar 0299-0311-00000-001

## GS9FSE & GS9FE Drywall Sander

Standard Accessories	
a1	Hook & Loop Sponge Backing Pad
b	Vacuum Hose 4M w/ Bayonet Adaptor
c	Velcro Strap
	Carry Bag
d	Bail Handle
Optional Accessories	Part Number
e	Hose Protector 0299-0091-00000-001
	Overload Protection
f	225 mm Mesh Dustless Sanding Discs - various grits



c Velcro Strap



d Bail Handle



e Hose Protector

## Drywall Sander 225 mm Mesh Sanding Discs

	Part Number
f	225 mm Fabric Mesh Dustless Sanding Discs (pack of 20 pieces each)
	Sanding Discs #80 0299-0264-00000-008
	Sanding Discs #100 0299-0264-00000-009
	Sanding Discs #120 0299-0264-00000-010
	Sanding Discs #150 0299-0264-00000-011
	Sanding Discs #180 0299-0264-00000-012
	Sanding Discs #220 0299-0264-00000-013



f 225 mm 9" Fabric Mesh Dustless Sanding Discs



g Carry Bag



h 540 mm Extension Bar

# H43 HIGH FREQUENCY INTEGRATED CONCRETE VIBRATOR

A high performance and durable high frequency concrete vibrator with integrated converter for the fastest possible concrete compaction. Excellent for challenging situations like moving a stiff mix into corners and around rebar. Available in custom hose lengths.



## Features

1. High frequency motor mounted directly in the vibrator head with hardened steel casing and heavy-duty bearings.
2. 400 Hz PMSM motor, as used in the aerospace industry, for higher efficiency and lighter weight than competitors' 200 Hz induction motors.
3. Sophisticated converter electronics protect the motor from overload and protect from over or under voltage. Special electronics allow the same unit to be used with either 110 or 220 V supply. There is no need for a separate converter - just plug directly into the outlet.
4. External aluminum heat sink for maximum cooling and easy cleaning.
5. Available with either type of hose clamping system upon request. (Band clamp type hose attachment is standard on H43.)
6. Reinforced Cable Support Strap protects power supply cable.
7. Waterproof IP67 construction

**Standard/ Optional Accessories See p. 94**

Model	H43
Power Input	700 W
Voltage, Frequency	110-240 V ~ 50-60 Hz
Vibration Rate	12,500 VPM
Motor Frequency	400 Hz
Centrifugal Force	2489 N
Vibrator Head Size	Ø 43 mm x 300 mm
Hose Size	Ø 36 mm x 5 m (Lengths 2 m, 3 m, and 6 m also available)
Ingress Protection Rating	IP67
Insulation Class	Class I
Switch box Dimensions (LxWxH)	260 x 180 x 120 mm
Weight	9.7 kg (21.3 lb)

# VR600, VRN1400 CONCRETE VIBRATORS - CABLE DRIVEN

Compact cable driven vibrators with universal motor for concrete compaction.



## Features

1. Direct drive universal motors.
2. High amplitude vibrator head.
3. Heavy-duty, kink-resistant flex shaft.
4. Externally accessible brushes for easy maintenance.

**Standard/ Optional Accessories See p. 94**

Model	VR600	VRN1400
Power Input	3 A (220-240 V), 5.5 A (110-120 V)	8.4 A (220-240 V), 14.8 A (110-120 V)
Power Output	0.33 kW	1.2 kW
Voltage, Frequency	220-240 V~ 50-60 Hz or 110-120 V~ 50-60 Hz	
No Load Speed	20,000 min <sup>-1</sup>	16,000 min <sup>-1</sup>
Vibration Rate	14,000 VPM	11,000 VPM
Soft Start	Without	With
Dimensions (LxWxH)(Motor unit only)	375 x 270 x 160 mm	290 x 234 x 243 mm
Weight (Motor unit only)	2.5 kg (5.5 lb)	4.2 kg (9.3 lb)
Characteristics / Certification		

# Concrete Vibrator Accessories

## H43

### High Frequency Integrated Concrete Vibrators

<b>Standard Accessories</b>
PRCD / GFCI Interrupter
<b>Optional Accessories</b>
* Custom hose lengths available according to customer request
* Press-fit type hose attachment according to customer request

## VR600, VRN1400

### Concrete Vibrators - Cable Driven

<b>Standard Accessories (VR600)</b>
Side Handle
<b>Standard Accessories (VRN1400)</b>
Side Handle
Support Strap

<b>Optional Accessories (VR600)</b>	<b>Part Number</b>
Concrete Vibrator Shafts - Flexible Type (Please indicate desired shaft when ordering.)	
Ø 30 mm x 1020 mm (M40-1.5)	305-00077-000-008
Ø 30 mm x 1800 mm (M40-1.5)	305-00077-000-009
<b>Optional Accessories (VRN1400)</b>	<b>Part Number</b>
Concrete Vibrator Shafts - Flexible Type (Please indicate desired shaft when ordering.)	
Ø 30 mm x 1020 mm (M42-1.5)	305-00077-000-001
Ø 30 mm x 1800 mm (M42-1.5)	305-00077-000-002
Ø 30 mm x 3020 mm (M42-1.5)	305-00077-000-003
Ø 39 mm x 1000 mm (M42-1.5)	305-00077-000-004
Ø 39 mm x 1780 mm (M42-1.5)	305-00077-000-005
Ø 39 mm x 3000 mm (M42-1.5)	305-00077-000-006

# ELECTRIC MIXERS EV32 - 105 mm EV52 - 140 mm EV42 - 120 mm EV160 - 160 mm

Electric mixers with revolutionary ergonomic design and sturdy mechanicals.



## Features

1. Electronic speed control thumb wheel (for EV42 and above) allows the operator to adjust the speed without taking his hands off the handles.
2. externally accessible brushes for easy maintenance.
3. 2-Speed Gear Box Selector Slider. (for EV52 & EV160)
4. Compound curved handle gives extra strength and ideal ergonomic hand position.
5. Cut-away handle for unobstructed view of work material.
6. Soft, non-slip TPR with textured surface for operator comfort.
7. Staggered Vent Louvers protects motor from dust ingress.

**Standard/ Optional Accessories See p. 97**

Model	EV32	EV42	EV52	EV160
Power Input	800 W	1100 W	1300 W	1600 W
Voltage, Frequency	220-240 V~ 50-60 Hz or 110-120 V~ 50-60 Hz			
No Load Speeds (Low Gear / High Gear)	750 min <sup>-1</sup>	250-700 min <sup>-1</sup>	150-400 / 250-700 min <sup>-1</sup>	180-350 / 280-550 min <sup>-1</sup>
Torque (Low Gear / High Gear)	6.0 Nm	11.0 Nm	27.4 / 17.3 Nm	42.7 / 29.9 Nm
Number Of Gears	1	1	2	2
Current (110V)	7.2 A	10.0 A	10.9 A	14.5 A
Current (230V)	3.6 A	4.8 A	5.2 A	7.0 A
Spindle Thread	M14-2.0			
Mixing Paddle (max.)	105 mm (4-1/8")	120 mm (4-11/16")	140 mm (5-1/2")	160 mm (6-5/16")
Electronic Speed Control	N/A	With	With	With
Dimensions (LxWxH) (Motor unit only)	322 x 250 x 190 mm	322 x 312 x 190 mm	345 x 322 x 190 mm	350 x 322 x 190 mm
Weight	2.9 kg (6.1 lb)	3.6 kg (7.9 lb)	4.1 kg (9.0 lb)	5.6 kg (12.4 lb)
Characteristics / Certification	CECB Only 220 V Only 220 V	CECB Only 220 V Only 220 V	CECB Only 220 V Only 220 V	CECB Only 220 V Only 220 V

# EV10ELM, EVP180, EV21 DRILL / MIXERS

Sturdy tools which can be used as a mixer as well as a heavy-duty 1/2" drill.





**EV10ELM**



**EVP180**



**EV21**

Model	EV10ELM	EVP180	EV21
Power Input	1100 W	1100 W	1100 W
Voltage, Frequency	220-240 V~ 50-60 Hz or 110-120 V~ 50-60 Hz		
No Load Speeds	0~750 min <sup>-1</sup>	750 min <sup>-1</sup>	800 min <sup>-1</sup>
Torque	12.6 Nm	12.6 Nm	12.6 Nm
Spindle Thread	M14-2.0	1/2"-20 UNF	1/2"-20 UNF
Max. Mixing Paddle Diameter	120 mm (4-11/16")	120 mm (4-11/16")	120 mm (4-11/16")
Drilling Capacity	Steel	N/A	13 mm (1/2")
	Wood	N/A	35 mm (1-3/8")
Switch	Variable Speed	Single Speed	Single Speed
Dimensions (LxWxH) (Motor unit only)	475 x 380 x 225 mm	390 x 100 x 130 mm	300 x 95 x 410 mm
Weight	4.8 kg (10.6 lb)	3.1 kg (6.8 lb)	3.3 kg (7.3 lb)
Characteristics / Certification	 <small>Only 220 V Only 220 V</small>	 <small>Only 220 V Only 220 V</small>	 <small>Only 220 V Only 220 V</small>

## EV32, EV42, EV52, EV160 Electric Mixers

## EV10ELM, EVP180, EV21 1/2"Drill / Mixers

### Standard Accessories

Wrench 22 mm

Mixing Paddle with 2 Helix

Soft Start on models EV42, EV52, EV160

### Optional Accessories

Mixing Paddles

### Standard Accessories

Wrench M22 (EV10ELM Only)

Wrench M13 (EV10ELM only)

M6 L-Hex Key (EV10ELM only)

M14 Adaptor (EVP180, EV21 only)

13mm Chuck & Chuck Key (EVP180, EV21 only)

### Optional Accessories

Mixing Paddles

Variable Speed Switch (EV10ELM only)

Soft Start (EV21 only)

## MIXING PADDLES

**Hex.** **M14**



Description	Diameter	Length	Mount	Part Number
TT Series 2 Helix (General Purpose ), Suitable for a wide range of uses.	120 mm	575 mm	M14	302-04155-905-001
	140 mm	590 mm	M14	302-04155-905-011
	160 mm	590 mm	M14	302-04155-905-004



TV Series 2 Helix (General Purpose), Like the TT series .	90 mm	400 mm	Hex.	302-04155-905-003
	120 mm	590 mm	Hex.	302-04155-905-015



TU Series 3 Helix (High Viscosity) Positive Twist (Pulls from the bottom up) For the highest viscosity materials.	120 mm	590 mm	M14	302-04155-905-007
	140 mm	590 mm	M14	302-04155-905-012
	160 mm	590 mm	M14	302-04155-905-008



TS Series 3 Helix (High Viscosity) Negative Twist (Pushes from the top down). Anti-splash effect.	120 mm	590 mm	M14	302-04155-905-018
	140 mm	590 mm	M14	302-04155-905-019
	160 mm	590 mm	M14	302-04155-905-009



Double Mixer-Left Hand	125 mm	650 mm	Hex. Quick Release	302-04155-905-006
Double Mixer-Right Hand	125 mm	650 mm	Hex. Quick Release	302-04155-905-005

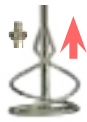

Round Bar 2 Helix (Low Load- High Speed)	105 mm	575 mm	M14	302-04155-905-002
---	--------	--------	-----	-------------------



Gate Type- (Low-Speed) Hex	6"	29"	Hex.	302-04155-905-013
Gate Type- (Low-Speed) M14	6"	29"	M14	302-04155-905-014

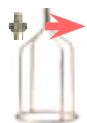

Anti-stick paddle. Excellent for avoiding lumps when mixing fine powders	120 mm	630 mm	M14	302-04155-905-016
--	--------	--------	-----	-------------------



Stainless steel, suitable for food processing.	125 mm	650 mm	M14	302-04155-905-017
--	--------	--------	-----	-------------------

## DE25, DEP25 WET / DRY VACUUM DUST EXTRACTORS

Purpose-built, 25 liter vacuums to work in conjunction with our power tools. The DE25 has integrated electric switching with tools up to 2200 W. The DEP25 has integrated pneumatic switching for air tools. Automatic electromagnetic filter shaker. High output 1200 W motor with bypass cooling.



### Features

1. Compact design with optimized balance for ease of movement around the worksite or on stairs.
2. 2-stage filter system with 25 Liter Dust Compartment.
3. Quick-release catches on dust compartment for convenient clearing of dust. Easy conversion between wet and dry modes.
4. Lockable rear wheels. Large diameter wheels easily roll across worksite debris and irregularities.
5. Handy cable storage with strap.
6. Front and rear hand-holds for convenient transporting.
7. Blower port.

Model	DE25	DEP25 (Pneumatic Switching Version)
Power Input	1200 W	
Voltage, Frequency	220-240 V~ 50-60 Hz or 110-120 V~ 50-60 Hz	
Max. Airflow	4000 l/min (141.3 CFM)	
Max. Suction (lift)	25 kpa (250 mbar, 100.4 inches of water)	
Ingress Protection	IP 44	
Max. Dust Capacity	25 L (6.6 gallons)	
Max. Connected Power Tool	2200 W	
Soft Start	With	
Dimensions (LxWxH)	598 x 408 x 420 mm	
Weight	12.9 kg (28.4 lb)	13.8 kg (30.4 lb)
Characteristics / Certification		

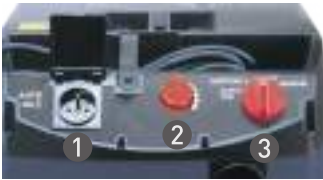

- ① Integrated Switching: Just pull the trigger of your power tool to automatically switch the vacuum on or off. When shutting off, suction continues for a few seconds to clear the hose of dust
- ② Variable Motor Speed Control. To tailor the suction to various applications and tools
- ③ Multi-mode switch for standard switch or power tool integrated switching



- **Pneumatic Switching Model DEP25**
- ④ Multi-mode switch for standard switch, power tool integrated switching, or air tool integrated switching. For integrated switching triggered by your air sander. **Remark:** Min. pressure: 3 bar

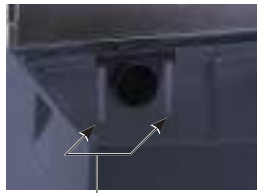

Liquid overflow switch shuts off machine when liquid level gets too high



High efficiency, 2-stage filter system



Convenient quick-release strap for stowing the hose

## DE25, DEP25 Wet / Dry Vacuum Dust Extractors

Standard Accessories	Part Number
a Vacuum Hose (4M)	0203-0007-00004-004
b1 Pleated Main Filters (L Class) (Each machine requires 2 pcs)	305-00079-000-001
c Washable Diaphragm Filter	0299-0029-00000-001
d Cloth Dust Bag with Hook & Loop Closure	299-0026-00000-003
Optional Accessories	Part Number
b2 Pleated Main Filters (M Class) (Each machine requires 2 pcs)	305-00079-000-002
e Wet Filters (Each machine requires 2 pcs)	305-00085-000-001
f Vacuum Hose End Adaptor	303-02026-004-001
g Paper Dust Bag	0299-0025-00000-001
h Handle (32 mm)	305-00307-000-001
h Crevice Nozzle (32 mm)	305-00307-000-003
h Floor Nozzle (32 mm, Horse Hair)	305-00307-000-004
h Round Brush (PP Hair, 32 mm)	305-00307-000-002
h Chrome Telescopic Tube (32 mm, 48/78 cm)	305-00307-000-005



a Vacuum Hose



c Washable Diaphragm Filter



d Cloth Dust Bag with Hook & Loop Closure



f Vacuum Hose End Adaptor



- h 1. Handle (32 mm)
- h 2. Crevice Nozzle (32 mm)
- h 3. Floor Nozzle (32 mm, Horse Hair)
- h 4. Round Brush (PP Hair, 32 mm)
- h 5. Chrome Telescopic Tube (32 mm, 48/78 cm)



b1 Pleated Main Filters (L Class)



b2 Pleated Main Filters (M Class)



e Wet Filters



g Paper Dust Bag

# MAGNETIC DRILLS









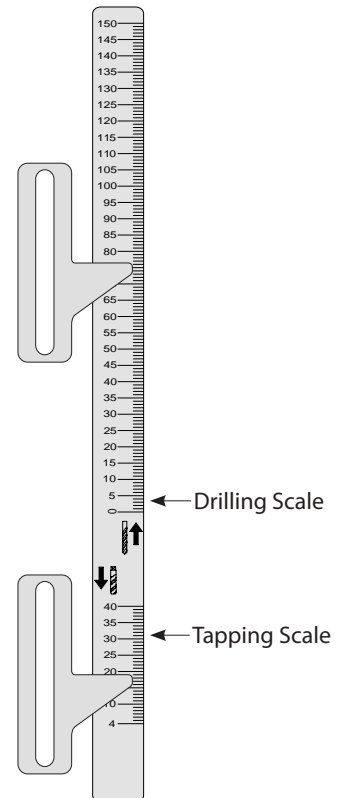

# TP2000 MAGNETIC TAPPING & DRILLING MACHINE

A patented, versatile, 1100 W magnetic tapping & drilling machine. Specially designed, two-mode gearbox with one setting for tapping with auto-reverse, and another setting for standard drilling. Convenient quick-release Bilz no.2 type coupling system.



④ Depth Meter (for blind holes)



Model	TP2000
Power Input	1100 W
Voltage, Frequency	220-240 V~ 50-60 Hz or 110-120 V~ 50-60 Hz
Tapping Mode: No Load (Rated Load) Speed	150 (90) min <sup>-1</sup> (350 min <sup>-1</sup> in reverse)
Drilling Mode: No Load (Rated Load) Speed	550 (330) min <sup>-1</sup>
Spindle Coupling	31 mm (Bilz no. 2)
Annular Cutter Arbor	Set Screw Type, 19.05 mm (3/4") Weldon Shank
Capacity, Taps: Ø	20 mm (13/16")
Capacity, Cutters: Ø x Depth of Cut	35 mm x 50 mm (1-3/8" x 2")
Capacity, Twist Drills (≤ 1/2" shank): Ø x Depth of Cut	13 mm x 150 mm (1/2" Shank x 6")
Magnetic Adhesion	15,000 N
Weight	14.5 kg (32.0 lb)
Characteristics / Certification	     



- ① Large Range Clamp Collet (Not Included)
- ② Universal Tap Chuck
- ③ Tap (Not included)
- ④ Coolant Feed Spring And Seal
- ⑤ Pilot Pin (Not included)
- ⑥ Annular Cutter Arbor 3/4" (19.05mm) Weldon Shank )
- ⑦ Annular Cutter (Not included)
- ⑧ 1/2" Twist Drill Chuck
- ⑨ Drill Chuck Arbor
- ⑩ Quick-Release Collar

**Mode Selector**

**Auto-Reverse Tapping Mode**

Drilling Mode

Tapping Mode

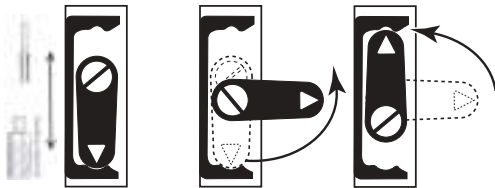

Annular Cutter Arbor  
(Annular cutter and pilot pin not included)

Drill Chuck Arbor



**Features**





1. 2 mode gear box for optimized torque and cutting speed.
2. Mode Selector for shifting between Auto-Reverse Tapping Mode or Standard Drilling Mode.
3. The Quick-Release arbor makes it quick and tool-free to change cutters and accessories.
4. Depth Meter.
5. Travel Limiter Stop.

**Standard/ Optional Accessories See p. 116**

## PMD3530 LOW PROFILE MAGNETIC DRILL

A low-profile single speed 1100 W magnetic drilling machine for up to Ø 35 x 35 mm standard sized cutters. It's compact size fits into 198 mm vertical spaces. The LED work light is very useful in dark work areas.



Model	PMD3530
Power Input	1100 W
Voltage, Frequency	220-240 V~ 50-60 Hz or 110-120 V~ 50-60 Hz
No Load (Rated Load) Speed	650 (390) min <sup>-1</sup>
Max. Capacity Ø x Depth of Cut	35 mm x 35 mm (1-3/8" x 1-3/8")
Cutter Shank	19.05 mm (3/4") Weldon
Magnetic Adhesion	15,000 N
Weight	10.5 kg (23.2 lb)
Characteristics / Certification	    

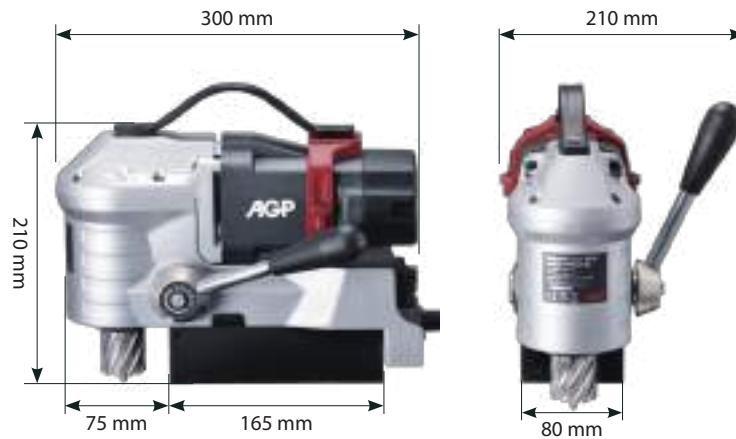

**Features**

1. 1-speed gear box for optimized torque and cutting speed.
2. The Quick-Release arbor makes it quick and tool-free to change cutters and accessories.
3. The adjustable tool-free lever can mount on either side.
4. LED light for working in dark spaces.
5. Ergonomic handle for convenient carrying.

**Standard/ Optional Accessories See p. 116**

# MD300N AUTO FEED MAGNETIC DRILL

1100 W electronically optimized automatic feed magnetic drilling machine with manual return for core drilling up to 30 mm diameter. Saves time and allows longer cutter life.



## Features

1. Auto feed saves time and maximizes productivity.
2. Dual-Purpose Crank Lever for switching between manual and auto feed.
3. 3 Position Feed Rate Selector for optimized auto feed.
4. Arbor Support bracket cutter stability.

**Standard/ Optional Accessories See p. 116**

Model	MD300N
Power Input	1100 W
Voltage, Frequency	220-240 V~ 50-60 Hz or 110-120 V~ 50-60 Hz
No Load (Rated Load) Speed	550 (330) min <sup>-1</sup>
Max. Capacity of Cutters	$\varnothing$ x Depth of Cut (Hand Feed) 35 mm x 50 mm (1-3/8" x 2") $\varnothing$ x Depth of Cut (Auto Feed) 30 mm x 45 mm (1-3/16" x 1-3/4")
Overload Protection	With
Magnetic Adhesion	15,000 N
Weight	15.9 kg (35.1 lb)
Characteristics / Certification	

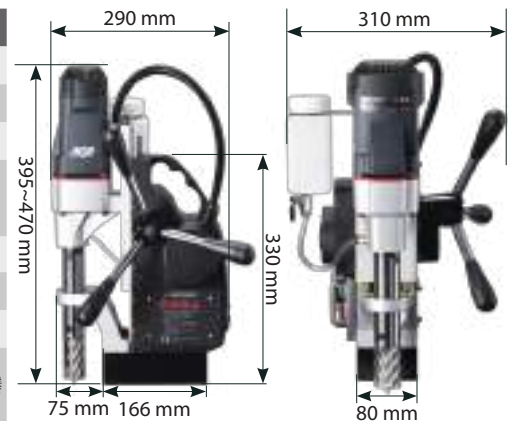

# SMD351L, SMD351H

## VARIABLE SLIDE MAGNETIC DRILLS WITH QUICK-RELEASE ARBOR

Single speed 1100 W magnetic drilling machines with quick-release arbor and adjustable slide height. The speed of the SMD 351L is optimized for HSS cutters up to Ø 42 x 50 mm and the SMD 351H is optimized for TCT cutters up to Ø 35 x 50 mm. Both are capable of twist drilling up to 1/2" shank.



### Features

1. A versatile and economical tool that fulfills the needs of most operators.
2. The quick-adjustable variable height slide allows quick conversion between cutters and twist drills. Lower for cutters, raise for twist drills.
3. The Quick-Release arbor makes it quick and tool-free to change cutters and accessories.

**Standard/ Optional Accessories See p. 116**

Model	SMD351L	SMD351H
Power Input	1100 W	
Voltage, Frequency	220-240 V~ 50-60 Hz or 110-120 V~ 50-60 Hz	
No Load (Rated Load) Speed	450 (270) min <sup>-1</sup>	730 (440) min <sup>-1</sup>
Max. Capacity	Ø x Depth of Cut of Cutters	
	SMD351L: 42 x 50 mm (1-5/8" x 2")	
	SMD351H: 35 x 50 mm (1-3/8" x 2")	
	Ø Twist Drills	
	≤ 1/2" shank	
	Stroke	
	140 mm (5-1/2")	
Overload Protection	With	
Magnetic Adhesion	15,000 N	
Weight	12.6 kg (27.7 lb)	
Characteristics / Certification		



Note: Choose the arbor type suitable for the cutter shank type available in your region. There are 4 types. See p. 115 for details.

# SMD352, SMD502

## TWO SPEED, VARIABLE SLIDE MAGNETIC DRILLS WITH QUICK-RELEASE ARBOR

2-speed 1100 W magnetic drilling machine with quick-release arbor and adjustable slide height. Choose the SMD 352 for cutters up to Ø 42 x 50 mm and the SMD 502 for cutters up to Ø 50 x 50 mm. Both are capable of twist drilling up to 1/2" shank.



### Features

1. 2-speed gear box for optimized torque and cutting speed for a wide range of cutting tools.
2. The quick-adjustable variable height slide allows quick conversion between cutters and twist drills. Lower for cutters, raise for twist drills.
3. The Quick-Release arbor makes it quick and tool-free to change cutters and accessories.

**Standard/ Optional Accessories See p. 117**

Model	SMD352	SMD502
Power Input	1100 W	
Voltage, Frequency	220-240 V~ 50-60 Hz or 110-120 V~ 50-60 Hz	
No Load (Rated Load)	Gear 1	450 (270) min <sup>-1</sup> / 300 (180) min <sup>-1</sup>
Speeds	Gear 2	730 (440) min <sup>-1</sup> / 450 (270) min <sup>-1</sup>
Max. Capacity	Ø x Depth of Cut of Cutters	
	SMD352: 42 mm x 50 mm (1-5/8" x 2") SMD502: 50 mm x 50 mm (2" x 2")	
	Ø Twist Drills	
	Stroke	
Overload Protection	Optional	With
Magnetic Adhesion	15,000 N	17,000 N
Weight	13.1 kg (28.8 lb)	14.8 kg (32.6 lb)
Characteristics / Certification		



Note: Choose the arbor type suitable for the cutter shank type available in your region. There are 4 types. See p. 119 for details.

# MD500/2 2-SPEED LONG-CUTTER MAGNETIC DRILL

A 2-speed 2000 W magnetic drilling machine for cutters up to Ø65 x 75 mm L and twist drills up to 16 mm (5/8") shank. Features extra long cutter capacity.



## Features

1. 2-speed gear box for optimized torque and cutting speed for a wide range of cutting tools.
2. Extra Long Cutter Capacity.
3. Arbor Support Bracket.

Standard/ Optional Accessories See p. 117

Model	MD500/2	
Power Input	2000 W (220 V), 1700 W (110 V)	
Voltage, Frequency	220-240 V~ 50-60 Hz or 110-120 V~ 50-60 Hz	
No Load (Rated Load)	Gear 1	380 (230) min <sup>-1</sup>
Speeds	Gear 2	550 (330) min <sup>-1</sup>
	Ø x Depth of Cut of Cutters	65 mm x 75 mm (2-9/16" x 3")
Max. Capacity	Ø Twist Drills	≤ 16 mm (5/8") shank
	Stroke	115 mm (4-1/2")
Overload Protection	With	
Magnetic Adhesion	32,000 N	
Weight	21.1 kg (46.5 lb)	
Characteristics / Certification		



# ST50

## 2-SPEED, MT2, SWIVEL BASE MAGNETIC DRILLING & TAPPING MACHINE WITH VARIABLE SPEED

A versatile MT2, two speed/ variable speed 1100 W magnetic core drilling machine for cutters up to Ø 50 x 50 mm, twist drills up to 23 mm, and taps up to M20. The MT2 arbor can also fit many other types of cutting tools. Features swivel base for access to difficult to reach areas. The variable speed and sophisticated electronics allow optimized cutting speeds.



Model	ST50	
Power Input	1100 W	
Voltage, Frequency	220-240 V~ 50-60 Hz or 110-120 V~ 50-60 Hz	
No Load (Rated Load) Speeds	Gear 1	150 - 300 (90 - 180) min <sup>-1</sup>
	Gear 2	225 - 450 (135 - 270) min <sup>-1</sup>
Max. Capacity	Ø x Depth of Cutters	50 mm x 50 mm (2" x 2")
	Drill Chuck Capacity	≤ 1/2" shank
	Ø of MT2 Twist Drills	20 mm (13/16")
	Ø of Taps	M20 (13/16")
	Stroke with MT2 Cutting Tools	150 mm (5-7/8")
Magnetic Adhesion	17,000 N	
Overload Protection & Soft Start	With	
Weight	16.4 kg (36.2 lb)	
Characteristics / Certification		



Standard 2 Jaw Universal Tap Chuck  
Steplessly grips any tap from M6 to M20 with 1/2"



Standard Chuck Adaptor  
Twist Drilling with 1/2" Chuck



MT2 Shank accessories such as twist drills up to 23 mm , reamers, countersinks, etc.



Swivel Base Equipped for difficult to reach areas  
Forward and back 15 mm



R&L 15°

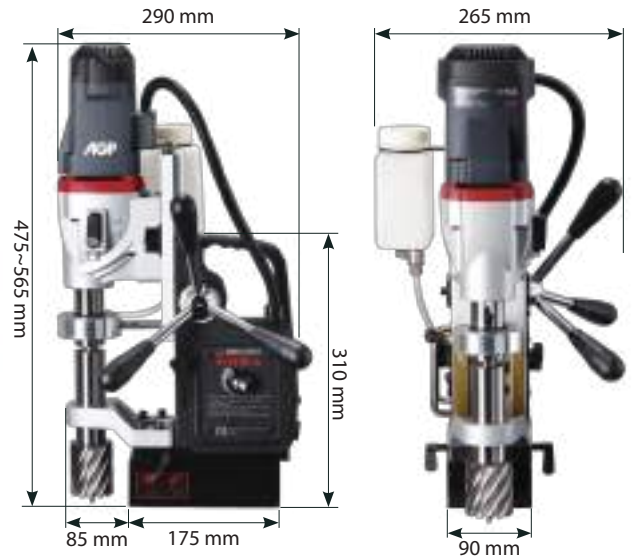

**Features**

1. 2-speed gear box with mechanical clutch for optimized torque and cutting speed.
2. Electronic Variable Speed Knob for optimized cutting speed.
3. Built-in cutting fluid system with unique through-the-spindle fluid feed.
4. Swivel Magnet Base equipped for difficult to reach areas.
5. Reversing Switch for tapping.
6. Arbor Support Bracket.

**Standard/ Optional Accessories See p. 117**

## **MD750/4**

### **4-SPEED, MT3 MAGNETIC DRILLING & TAPPING MACHINE**

## **MDS750/4**

### **4-SPEED, MT3 SWIVEL BASE MAGNETIC DRILLING & TAPPING MACHINE**

4-speed 2000 W heavy-duty magnetic drilling machine for cutters up to Ø 75 x 50 mm, twist drills up to 32 mm, and taps up to 25.4 mm. The MT3 arbor can also fit many other types of cutting tools. MDS750/4 features swivel Base for difficult to reach areas.



**MD750/4**

**MDS750/4**

Model	MD750/4	MDS750/4
Power Input	2000 W (220-240 V), 1700 W (110-120 V)	
Voltage, Frequency	220-240 V~ 50-60 Hz or 110-120 V~ 50-60 Hz	
No Load (Rated) Speeds	Gear 1	150 (90) min <sup>-1</sup>
	Gear 2	200 (120) min <sup>-1</sup>
	Gear 3	300 (180) min <sup>-1</sup>
	Gear 4	380 (230) min <sup>-1</sup>
Max. Capacity	Ø x Depth of Cut of Annular Cutters	75 mm x 50 mm (3" x 2")
	Drill Chuck Capacity	≤ 16 mm (5/8") shank
	Ø of MT3 Twist Drill	32 mm (1-1/4")
	Ø of Taps	25.4 mm (1")
	Stroke with MT3 Cutting Tools	145 mm (5-11/16")
Overload Protection	With	
Magnetic Adhesion	32,000 N	
Weight	24.4 kg (53.8 lb)	27.8 kg (61.3 lb)
Characteristics / Certification		

■ **Twist Drilling with Chuck**



MT3 Chuck Adaptor and Chuck (optional)

■ **Twist Drilling**



MT3 Twist Drill Bit (Not included)

■ **SWIVEL BASE EQUIPPED MODELS (MDS750/4)** for difficult to reach areas

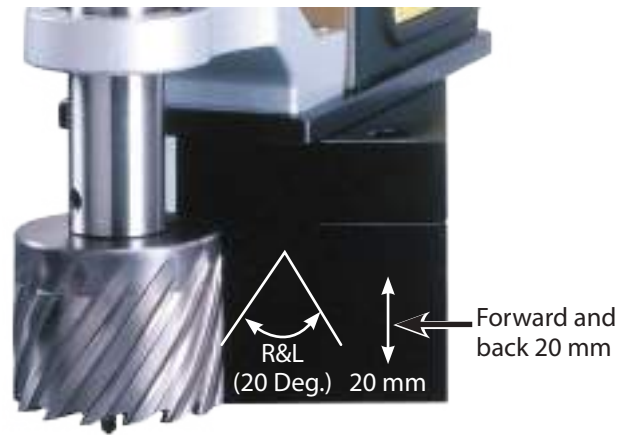

■ **Tapping Mode (Optional)**



MT3 #2 Range Tapping Chuck & Clamp Collet



MT3 #1 Range Tapping Chuck & Clamp Collet



Quick-Release Annular Cutter Arbor for cutters up to Ø 60 mm



**MD750/4**



**MDS750/4**



**Features**

1. 4-speed gear box for optimized torque and cutting speed for a wide range of cutting tools.
2. Built-in cutting fluid system with unique through-the-spindle fluid feed.
3. Swivel Magnet Base Equipped for difficult to reach areas. (MDS750/4)
4. Reversing Switch for tapping.

**Standard/ Optional Accessories See p. 118**

# MD120/4

## 4-SPEED, MT3 MAGNETIC DRILLING & TAPPING MACHINE WITH VARIABLE SPEED

A 4-speed, 2000 W heavy-duty magnetic drilling machine for cutters up to Ø120 x 50 mm, twist drills up to 32 mm, and taps up to M32. The MT3 arbor can also fit many other types of cutting tools. The variable constant speed and sophisticated electronics allow optimized cutting speeds. The gearbox features a mechanical clutch for safety.



Model	MD120/4	
Power Input	2000 W (220-240 V), 1700 W (110-120 V)	
Voltage, Frequency	220-240 V~ 50-60 Hz or 110-120 V~ 50-60 Hz	
* Rated Load Speeds	Gear 1	35 - 115 min <sup>-1</sup>
	Gear 2	70 - 210 min <sup>-1</sup>
	Gear 3	80 - 250 min <sup>-1</sup>
	Gear 4	140 - 450 min <sup>-1</sup>
Max. Capacity	Ø x Depth of Cut (with Set-Screw Type Cutter Arbor)	120 mm x 50 mm (4-3/4" x 2"), (100 mm (4") depth optional)
	Ø x Depth of Cut (with Quick-Release Cutter Arbor)	60 mm x 50 mm (2-3/8" x 2")
	Chuck Capacity	≤ 16 mm (5/8") shank
	Ø of MT3 Twist Drills	32 mm (1-1/4")
	Ø of Taps	32 mm (1-1/4")
	Stroke	215 mm (8-1/2")
	Max. Spindle Height	295 mm (11-5/8")
Overload Protection	With	
Magnetic Adhesion	32,000 N	
Weight	29.3 kg (64.6 lb)	

Characteristics / Certification



\* Due to the constant speed design, the no load and the rated load speeds are roughly the same.

■ Tapping Mode (Optional)



■ Twist Drilling with Chuck

■ Twist Drilling

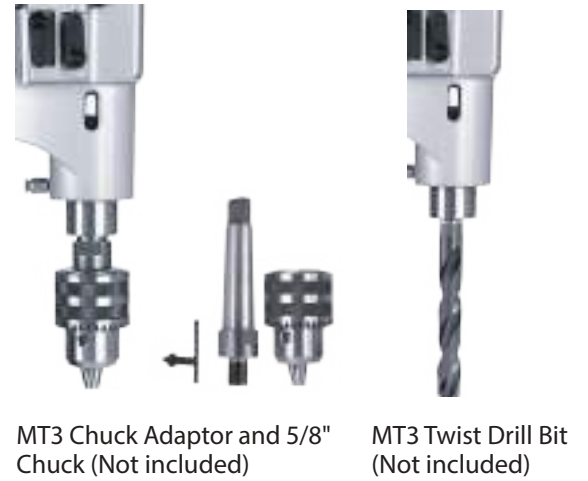

**Features**

1. 4-speed gear box with mechanical clutch for optimized torque and cutting speed for a wide range of cutting tools.
2. Built-in cutting fluid system for cutters with unique through-the-spindle fluid feed.
3. Stepless variable speed wheel for electronic speed control with constant speed circuitry.
4. Reversing Switch for tapping.
5. Special MT3 high-torque tang drive spindle (mounts any MT3 accessory).

**Standard/ Optional Accessories See p. 119**

# Magnetic Drilling Accessories

## TP2000 Magnetic Tapping & Drilling Machine



**a** Large Range Bilz no.2  
Clamp Collets

Standard Accessories	
Universal Tap Chuck	
Wrench M8	
L-Hex Key M2.5	
L-Hex Key M4	
Drill Chuck Adaptor Arbor	
1/2" Chuck And Chuck Key	
Annular Cutter Arbor	
Coolant Tank Kit	
Chip Guard Kit	
Ratchet Strap	
Optional Accessories	Part Number
<b>a</b> Other sizes of Clamp Collets	See p. 120

## PMD3530 Low Profile Magnetic Drill

Standard Accessories
Ratchet Strap
Chip Guard Kit
Optional Accessories
Overload Protection

## MD300N Auto Feed Magnetic Drill

Standard Accessories
Wrench M8
L-Hex Key M2.5
L-Hex Key M4
Chip Guard Kit
Coolant Tank Kit
Ratchet Strap

## SMD351L, SMD351H

### Variable Slide Magnetic Drills With Quick-Release Arbor

Standard Accessories
Wrench M8
L-Hex Key M2.5
L-Hex Key M4
T- Wrench M6
Coolant Tank Kit
Ratchet Strap
Chip Guard Kit
Optional Accessories
Overload Protection
Quick-Release Chuck Adaptor

## **SMD352, SMD502**

### **Two Speed, Variable Slide Magnetic Drills With Quick-Release Arbor**

Standard Accessories
Wrench M8
L-Hex Key M2.5
L-Hex Key M4
T-wrench M6
Coolant Tank kit
Ratchet Strap
Chip Guard Kit
Overload Protection (SMD502)
Optional Accessories
Overload Protection (SMD352)
Quick-Release Chuck Adaptor

## **MD500/2 Long Cutter 2-Speed Magnetic Drill**

Standard Accessories
Wrench M8
L-Hex Key M2.5
L-Hex Key M4
Chip Guard Kit
Coolant Tank Kit
Ratchet Strap
Optional Accessories
Chuck Adaptor
5/8" (16 mm) Chuck & Chuck Key
Quick-Release Cutter Arbor

## **ST50**

### **2-Speed, MT2, Swivel Base Magnetic Drilling & Tapping Machine With Variable Speed**

Standard Accessories
MT2 Annular Cutter Arbor
Drift
Wrench M8
L-Hex Key M2.5
L-Hex Key M4
L-Hex Key M5
Coolant Tank Kit
Chip Guard Kit
Ratchet Strap
MT2 Chuck Adaptor
MT2 Universal Tap Chuck
Optional Accessories
1/2" (13 mm) Chuck, Key

# Magnetic Drilling Accessories

## MD750/4

### 4-Speed, MT3 Magnetic Drilling & Tapping Machine

Standard Accessories	
MT3 Annular Cutter Arbor (set screw type)	
Wrench M8	
L-Hex Key M2.5	
L-Hex Key M4	
Chip Guard Kit	
Coolant Tank Kit	
Ratchet Strap	
Drift	
Optional Accessories	
MT3 Chuck Adaptor	
5/8" (16 mm) Chuck & Chuck Key	
MT3 Tapping Adaptors	
Tapping Attachments	
Pipe Vise For Pipe Diameters 32 mm - 203 mm (1-1/4" - 8-1/4")	0299-0062-00000-002
MT3 Quick-Release Annular Cutter Arbor	



Pipe Vise

## MDS750/4

### 4-Speed, MT3 Swivel Base Magnetic Drilling & Tapping Machine

Standard Accessories	
MT3 Annular Cutter Arbor (set screw type)	
Wrench M8	
L-Hex Key M2.5	
L-Hex Key M4	
Chip Guard Kit	
Coolant Tank Kit	
Ratchet Strap	
Drift	
Wrench M17	
Optional Accessories	
MT3 Chuck Adaptor	
5/8" (16 mm) Chuck & Chuck Key	
MT3 Tapping Adaptors	
Tapping Attachments	
Pipe Vise For Pipe Diameters 32 mm - 203 mm (1-1/4" - 8-1/4")	0299-0062-00000-001
MT3 Quick-Release Annular Cutter Arbor	



Pipe Vise

# MD120/4

## 4-Speed, MT3 Magnetic Drilling & Tapping Machine With Variable Speed

Standard Accessories
Wrench M8
L-Hex Key M2.5
L-Hex Key M5
Chip Guard Kit
Coolant Tank Kit
Ratchet Strap
Drift
MT3 (1-1/4" Weldon) Annular Cutter Arbor, 50 mm depth (set screw type)
MT3 (3/4" Weldon) Annular Cutter Arbor, 50 mm depth (set screw type)
Optional Accessories
MT3 Chuck Adaptor
5/8" (16 mm) Chuck & Chuck Key
MT3 Tapping Adaptors
Tapping Attachments
MT3 (3/4" Weldon) Quick-Release Annular Cutter Arbor, 50 mm depth
MT3 (1-1/4" Weldon) Annular Cutter Arbor, 100 mm depth, (set screw type)
MT3 (3/4" Weldon) Annular Cutter Arbor, 75 mm depth, (set screw type)

## Vacuum Base Adapter

For drilling up to Ø55 mm holes on surfaces where the magnet's adhesion would not work or would be problematic, such as:

- Non-magnetic surfaces
- Thin steel
- Patterned surfaces such as diamond plate.

Note: This vacuum base reduces the effective depth of cut by 30 mm, so 50 mm or longer cutters must be used.



Model	Vacuum Base Adapter
Applicable Models	All AGP mag drill models
Required Vacuum	-0.8 bar (-26 inHg)
Required Flow Rate	30 L/min (1 cfm)
Maximum Annular Cutter	Ø55 mm
Dimensions (LxWxH)	234 x 209 x 81 mm
Weight	5.3 kg (11.7 lb)



VP140 Vacuum Pump See p. 67

## MD750/4, MDS750/4, MD120/4 Tapping Attachments MT3 #1 Range Tapping Chuck & #1 Range Clamp Collets

**a** MT3 Small Range Tapping Chuck (For Clamp Collets 3 ~ 15mm) **302-04293-901-001**

Clamp Collets				Clamp Collets			
Nominal Tap	Shank	Size of	Part Number	Nominal Tap	Shank	Size of	Part Number
Sizes:	Dia.:	Square:		Sizes:	Dia.:	Square:	
M3-JIS	4.0	3.2	305-00155-000-001	UNC1/2-JIS	9.0	7.0	305-00155-000-041
M4-JIS	5.0	4.0	305-00155-000-002	M3.5-DIN376	2.5	2.1	305-00155-000-015
M5-JIS	5.5	4.5	305-00155-000-003	M4-DIN376	2.8	2.1	305-00155-000-016
M6-JIS	6.0	4.5	305-00155-000-004	M4.5 / M5 -DIN376	3.5	2.7	305-00155-000-017
M7/M8-JIS	6.2	5.0	305-00155-000-005	M6-DIN376	4.5	3.4	305-00155-000-019
M9/M10-JIS	7.0	5.5	305-00155-000-006	M7-DIN376	5.5	4.3	305-00155-000-020
M11-JIS	8.0	6.0	305-00155-000-007	M8-DIN376	6.0	4.9	305-00155-000-021
M12-JIS	8.5	6.5	305-00155-000-008	M10-DIN376	7.0	5.5	305-00155-000-022
M14/M15-JIS	10.5	8.0	305-00155-000-009	M12-DIN376	9.0	7.0	305-00155-000-023
UNC5/16-JIS	6.1	5.0	305-00155-000-040	M14-DIN376	11.0	9.0	305-00155-000-024



## MT3 #2 Range Tapping Chuck & #2 Range Clamp Collets

**c** MT3 Large Range Tapping Chuck (For Clamp Collets 7 ~ 25mm) **302-04293-901-002**

Clamp Collets				Clamp Collets			
Nominal Tap	Shank	Size of	Part Number	Nominal Tap	Shank	Size of	Part Number
Sizes:	Dia.:	Square:		Sizes:	Dia.:	Square:	
M7/M8-JIS	6.2	5.0	305-00155-000-030	UNC 1/2-JIS	9.0	7.0	305-00155-000-042
M9/M10-JIS	7.0	5.5	305-00155-000-031	UNC 5/8-JIS	12.0	9.0	305-00155-000-046
M11-JIS	8.0	6.0	305-00155-000-032	M8-DIN376	6.0	4.9	305-00155-000-036
M12-JIS	8.5	6.5	305-00155-000-033	M10-DIN376	7.0	5.5	305-00155-000-037
M14/M15-JIS	10.5	8.0	305-00155-000-034	M12-DIN376	9.0	7.0	305-00155-000-038
M16-JIS	12.5	10.0	305-00155-000-010	M14-DIN376	11.0	9.0	305-00155-000-039
M18-JIS	14.0	11.0	305-00155-000-011	M16-DIN376	12.0	9.0	305-00155-000-025
M20-JIS	15.0	12.0	305-00155-000-012	M18-DIN376	14.0	11.0	305-00155-000-026
M22 / UNC7/8 -JIS	17.0	13.0	305-00155-000-013	M20-DIN376	16.0	12.0	305-00155-000-027
M24/M25-JIS	19.0	15.0	305-00155-000-014	M22 / M24 -DIN376	18.0	14.5	305-00155-000-028



## MT3 Annular Cutter Arbors w/ 19.05 (3/4") or 31.75 mm (1-1/4") Weldon Shank

( 2 Set Screws, C- clip, Washer, O-ring, Water seal , and Spring are included )

Sizes:	Application	Part Number
<b>e</b> ø19.05 mm (3/4") (L 186 mm), 50 mm depth	MD120/4	0299-0078-00000-003
<b>e</b> ø19.05 mm (3/4") (L 212 mm), 50 mm depth	MD750/4	0299-0078-00000-009
<b>f</b> ø19.05 mm (3/4") (L 237 mm), 75 mm depth	MDS750/4, MD120/4	0299-0078-00000-010
<b>g</b> ø31.75 mm (1-1/4") (L 156 mm), 50 mm depth	MD120/4	0299-0078-00000-035
<b>h</b> ø31.75 mm (1-1/4") (L 223 mm), 100 mm depth	MD120/4	0299-0078-00000-042



## MT3 Quick-Release Annular Cutter Arbors w/19.05 (3/4") Weldon Shank\*

( Spring & Water seal are included )

Sizes:	Application	Part Number
Single flat side with lock pin 12.3 mm (type A1)	MD750/4, MD120/4	0299-0078-00000-001
Single flat side with lock pin 11.7 mm (type B1)	MD750/4, MD120/4	0299-0078-00000-005
Single flat side with lock pin 12.3 mm (type A1)	MDS750/4	0299-0078-00000-012
Single flat side with lock pin 11.7 mm (type B1)	MDS750/4	0299-0078-00000-015
Two flat side with lock pin 12.3 mm (type A2)	MDS750/4	0299-0078-00000-024
Two flat side with lock pin 11.7 mm (type B2)	MDS750/4	0299-0078-00000-016



\*60 mm cutter maximum capacity

## Quick-Release Chuck Adaptors

Description: Allows Chuck to mount in Quick-Release Arbor	Application	Part Number
Single flat, 17.4 mm (std. deep flat type A1)	SMD series	302-04240-901-001
Two flats, 17.4 mm (std. deep flat type A2)		302-04240-901-002
Single flat, 17.9 mm (shallow flat type B1)		302-04240-903-003
Two flats, 17.8 mm (shallow flat type B2)		302-04240-903-004



## Pilot Pins

Description:	Dimensions	Part Number
Pilot Pin for 12-17 mm TCT 35L cutters	TCT - 90L x Ø 6.34 mm	305-00016-000-009
Pilot Pin for 18-60 mm TCT 35L cutters	TCT - 90L x Ø 7.98 mm	305-00016-000-008
Pilot Pin for 12-17 mm TCT 50L cutters	TCT - 106L x Ø 6.34 mm	305-00016-000-010
Pilot Pin for 18-60 mm TCT 50L cutters	TCT - 108L x Ø 7.98 mm	305-00016-000-011
Pilot Pin for 12-100 mm HSS 30L cutters	HSS - 77L x Ø 6.34 mm	305-00016-000-002
Pilot Pin for 12-100 mm HSS 50L cutters	HSS - 103L x Ø 6.34 mm	305-00016-000-003



## Chuck Adaptors (to mount chuck to motor spindle)

Description:	Mount	Application	Part Number
<b>i</b> Chuck Adaptor for 5/8" Chucks	M27-3.0 / 5/8"-16	MD500/2	302-04020-901-014
<b>j</b> Chuck Adaptor for 5/8" Chucks	MT3 / 5/8"-16	MD750/4, MDS750/4, MD120/4	0202-0016-00000-001
<b>k</b> Chuck Adaptor for B16 Taper Mount Chucks	MT3 / B16		302-04020-901-009



## Drill Chucks & Chuck Keys

Description & Clamping Capacity	Mount	Application	Part Number
5/8" Chuck (w/ Key) (1 mm~16 mm)	5/8"-16	EVP180, MD750/4, MDS750/4, MD500/2, MD120/4	305-00014-000-002
1/2" Chuck (w/ Key) (1 mm~13 mm)	1/2"-20	EV21, SMD351H, SMD351L, SMD352, SMD502, ST50, TP2000	305-00014-000-001



## Magnetic Chip Collector

(Push in the plunger to activate magnetic force to collect chips, Pull back the plunger to release the chips.)

Dimensions	Part Number
400 mm x 25 mm	305-00173-000-001



## Quick-Release Arbor Type

Quick-release arbors must be selected to be compatible with the cutter shank type available in your market.

There are 4 basic types: (type A1 is our default type)

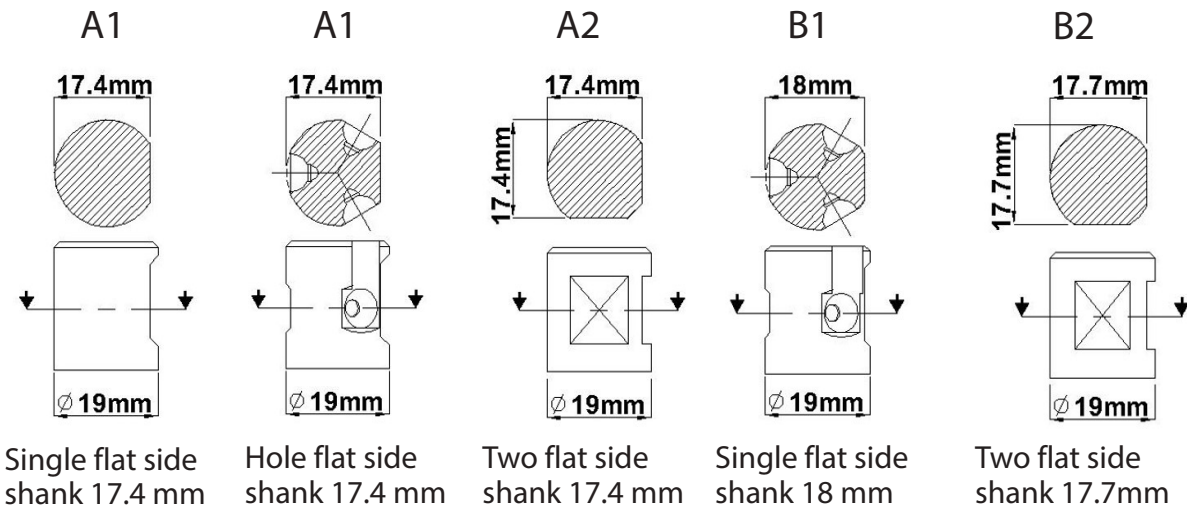

# Magnetic Drilling Accessories

## TCT Annular Cutters With 19.05 mm (3/4") Universal Shank (Sizes 65 mm ~ 75 mm with 31.75 mm (1-1/4") Universal Shank)

35 mm Length Cutters		
Spec.	Park Number	
12 mm x 35L	305-00161-000-096	
13 mm x 35L	305-00161-000-099	
14 mm x 35L	305-00161-000-001	
15 mm x 35L	305-00161-000-002	
16 mm x 35L	305-00161-000-003	
17 mm x 35L	305-00161-000-004	
18 mm x 35L	305-00161-000-005	
19 mm x 35L	305-00161-000-006	
20 mm x 35L	305-00161-000-007	
21 mm x 35L	305-00161-000-008	
22 mm x 35L	305-00161-000-009	
23 mm x 35L	305-00161-000-010	
24 mm x 35L	305-00161-000-011	
25 mm x 35L	305-00161-000-012	
26 mm x 35L	305-00161-000-013	
27 mm x 35L	305-00161-000-014	
28 mm x 35L	305-00161-000-015	
29 mm x 35L	305-00161-000-016	
30 mm x 35L	305-00161-000-017	

35 mm Length Cutters		
Spec.	Park Number	
31 mm x 35L	305-00161-000-018	
32 mm x 35L	305-00161-000-019	
33 mm x 35L	305-00161-000-020	
34 mm x 35L	305-00161-000-021	
35 mm x 35L	305-00161-000-022	
36 mm x 35L	305-00161-000-023	
37 mm x 35L	305-00161-000-024	
38 mm x 35L	305-00161-000-025	
39 mm x 35L	305-00161-000-026	
40 mm x 35L	305-00161-000-027	
41 mm x 35L	305-00161-000-028	
42 mm x 35L	305-00161-000-029	
43 mm x 35L	305-00161-000-030	
44 mm x 35L	305-00161-000-031	
45 mm x 35L	305-00161-000-032	
46 mm x 35L	305-00161-000-033	
47 mm x 35L	305-00161-000-034	
48 mm x 35L	305-00161-000-035	
49 mm x 35L	305-00161-000-036	
50 mm x 35L	305-00161-000-037	



Long-wearing Tungsten Carbide Tips

(Sizes 50L x 76 mm up to 100 mm available on request.)

50 mm Long Reach Cutters		
Spec.	Park Number	
16 mm x 50L	305-00161-000-097	
17 mm x 50L	305-00161-000-098	
18 mm x 50L	305-00161-000-038	
19 mm x 50L	305-00161-000-039	
20 mm x 50L	305-00161-000-040	
21 mm x 50L	305-00161-000-041	
22 mm x 50L	305-00161-000-042	
23 mm x 50L	305-00161-000-043	
24 mm x 50L	305-00161-000-044	
25 mm x 50L	305-00161-000-045	
26 mm x 50L	305-00161-000-046	
27 mm x 50L	305-00161-000-047	
28 mm x 50L	305-00161-000-048	
29 mm x 50L	305-00161-000-049	
30 mm x 50L	305-00161-000-050	
31 mm x 50L	305-00161-000-051	
32 mm x 50L	305-00161-000-052	
33 mm x 50L	305-00161-000-053	
34 mm x 50L	305-00161-000-054	
35 mm x 50L	305-00161-000-055	
36 mm x 50L	305-00161-000-056	
37 mm x 50L	305-00161-000-057	
38 mm x 50L	305-00161-000-058	
39 mm x 50L	305-00161-000-059	
40 mm x 50L	305-00161-000-060	
41 mm x 50L	305-00161-000-061	
42 mm x 50L	305-00161-000-062	
43 mm x 50L	305-00161-000-063	
44 mm x 50L	305-00161-000-064	
45 mm x 50L	305-00161-000-065	

50 mm Long Reach Cutters		
Spec.	Park Number	
46 mm x 50L	305-00161-000-066	
47 mm x 50L	305-00161-000-067	
48 mm x 50L	305-00161-000-068	
49 mm x 50L	305-00161-000-069	
50 mm x 50L	305-00161-000-070	
51 mm x 50L	305-00161-000-071	
52 mm x 50L	305-00161-000-072	
53 mm x 50L	305-00161-000-073	
54 mm x 50L	305-00161-000-074	
55 mm x 50L	305-00161-000-075	
56 mm x 50L	305-00161-000-076	
57 mm x 50L	305-00161-000-077	
58 mm x 50L	305-00161-000-078	
59 mm x 50L	305-00161-000-079	
60 mm x 50L	305-00161-000-080	
61 mm x 50L	305-00161-000-081	
62 mm x 50L	305-00161-000-082	
63 mm x 50L	305-00161-000-083	
64 mm x 50L	305-00161-000-084	

31.75 mm (1-1/4") Shank		
65 mm x 50L	305-00161-000-085	
66 mm x 50L	305-00161-000-086	
67 mm x 50L	305-00161-000-087	
68 mm x 50L	305-00161-000-088	
69 mm x 50L	305-00161-000-089	
70 mm x 50L	305-00161-000-090	
71 mm x 50L	305-00161-000-091	
72 mm x 50L	305-00161-000-092	
73 mm x 50L	305-00161-000-093	
74 mm x 50L	305-00161-000-094	
75 mm x 50L	305-00161-000-095	

(Sizes 35L x 51 mm up to 100 mm available on request.)

# HSS Annular Cutters with 19.05 mm (3/4") Weldon Shank

30 mm Length Cutters	
Spec.	Park Number
12 mm x 30L	305-00162-000-001
13 mm x 30L	305-00162-000-002
14 mm x 30L	305-00162-000-003
15 mm x 30L	305-00162-000-004
16 mm x 30L	305-00162-000-005
17 mm x 30L	305-00162-000-006
18 mm x 30L	305-00162-000-007
19 mm x 30L	305-00162-000-008
20 mm x 30L	305-00162-000-009
21 mm x 30L	305-00162-000-010
22 mm x 30L	305-00162-000-011
23 mm x 30L	305-00162-000-012
24 mm x 30L	305-00162-000-013
25 mm x 30L	305-00162-000-014
26 mm x 30L	305-00162-000-015
27 mm x 30L	305-00162-000-016
28 mm x 30L	305-00162-000-017
29 mm x 30L	305-00162-000-018
30 mm x 30L	305-00162-000-019



Resharpenable HSS tool steel cutters

(Sizes 50L x 76 mm up to 100 mm available on request.)

30 mm Length Cutters	
Spec.	Park Number
31 mm x 30L	305-00162-000-020
32 mm x 30L	305-00162-000-021
33 mm x 30L	305-00162-000-022
34 mm x 30L	305-00162-000-023
35 mm x 30L	305-00162-000-024
36 mm x 30L	305-00162-000-025
37 mm x 30L	305-00162-000-026
38 mm x 30L	305-00162-000-027
39 mm x 30L	305-00162-000-028
40 mm x 30L	305-00162-000-029
41 mm x 30L	305-00162-000-030
42 mm x 30L	305-00162-000-031
43 mm x 30L	305-00162-000-032
44 mm x 30L	305-00162-000-033
45 mm x 30L	305-00162-000-034
46 mm x 30L	305-00162-000-035
47 mm x 30L	305-00162-000-036
48 mm x 30L	305-00162-000-037
49 mm x 30L	305-00162-000-038
50 mm x 30L	305-00162-000-039

50 mm Length Cutters	
Spec.	Park Number
12 mm x 50L	305-00162-000-040
13 mm x 50L	305-00162-000-041
14 mm x 50L	305-00162-000-042
15 mm x 50L	305-00162-000-043
16 mm x 50L	305-00162-000-044
17 mm x 50L	305-00162-000-045
18 mm x 50L	305-00162-000-046
19 mm x 50L	305-00162-000-047
20 mm x 50L	305-00162-000-048
21 mm x 50L	305-00162-000-049
22 mm x 50L	305-00162-000-050
23 mm x 50L	305-00162-000-051
24 mm x 50L	305-00162-000-052
25 mm x 50L	305-00162-000-053
26 mm x 50L	305-00162-000-054
27 mm x 50L	305-00162-000-055
28 mm x 50L	305-00162-000-056
29 mm x 50L	305-00162-000-057
30 mm x 50L	305-00162-000-058

50 mm Length Cutters	
Spec.	Park Number
31 mm x 50L	305-00162-000-059
32 mm x 50L	305-00162-000-060
33 mm x 50L	305-00162-000-061
34 mm x 50L	305-00162-000-062
35 mm x 50L	305-00162-000-063
36 mm x 50L	305-00162-000-064
37 mm x 50L	305-00162-000-065
38 mm x 50L	305-00162-000-066
39 mm x 50L	305-00162-000-067
40 mm x 50L	305-00162-000-068
41 mm x 50L	305-00162-000-069
42 mm x 50L	305-00162-000-070
43 mm x 50L	305-00162-000-071
44 mm x 50L	305-00162-000-072
45 mm x 50L	305-00162-000-073
46 mm x 50L	305-00162-000-074
47 mm x 50L	305-00162-000-075
48 mm x 50L	305-00162-000-076
49 mm x 50L	305-00162-000-077
50 mm x 50L	305-00162-000-078

(Sizes 30L x 51 mm up to 100 mm available on request.)

# CS200, CS230N METAL CUTTING CIRCULAR SAWS

Quickly cut metals such as steel, stainless, aluminum and others using TCT dry cut blades for accurate, burr-free cuts.



## Features

1. Handle is in the same plane with the blade for ideal balance, control, and ease of pushing.
2. Bayonet mount locking knob for Blade Cover for quick clearing of swarf.
3. Side Handle affixed to the base gives superior stability during bevel cuts.
4. Adjustable Rip Fence.
5. Base Mount Bracket for Side Handle.
6. Bevels up to 45°.
7. Tool-Free Bevel Changes with 5 Detents.
8. Quick, Tool-Free Depth Adjustment.
9. Speed Control. (optional)

**Standard/ Optional Accessories See p. 127**

Model	CS200	CS230N
Power Input	1700 W	
Voltage, Frequency	220-240 V~ 50-60 Hz or 110-120 V~ 50-60 Hz	
No Load (Rated Load) Speed	3700 (2200) min <sup>-1</sup>	2200 (1320) min <sup>-1</sup>
Bevels	0° to 45°	
TCT Saw Blade	200 mm ( 8")	230 mm ( 9")
Arbor	30 mm (1-3/16") or 25.4 mm (1")	
Cutting Capacities	Straight Cut: 67 mm (2-5/8") 45° Bevel: 42 mm (1-5/8")	Straight Cut: 80 mm (3-1/4") 45° Bevel: 56 mm (2-3/16")
Soft Start & Overload Protection	With	
Dimensions (LxWxH)	368 x 284 x 330 mm	383 x 301 x 360 mm
Weight	6.3 kg (13.6 lb)	7.1 kg (15.6 lb)
Characteristics / Certification		

# CS320 METAL CUTTING CIRCULAR SAW

PATENTED

Quickly cut metals such as steel, stainless, aluminum and others using 320 mm TCT dry cut blades for accurate, burr-free cuts. Extra deep 121 mm depth of cut and optional guide rail make it especially suited to cutting thick, corrugated sandwich panels.



**OPTIONAL ACCESSORIES:**

The guide rail allows perfectly straight cuts and the cut-to-fit rubber strip shows the operator exactly where the cutting line will be.



**Features**

1. Unique, patented dust chamber cover opens and snaps closed in seconds. Highly effective dust and debris collection.
2. Large cutting capacity provided by the 320 mm metal cutting blade. A full 121 mm depth of cut when mounted on a guide rail.
3. Guide clearance adjustor.
4. Kicker Lever for opening the lower blade guard on thick, soft-cored sandwich panels.
5. LED Load Indicator enables maximum efficiency.

**Standard/ Optional Accessories See p. 127**

Model	CS320
Power Input	1800 W (220-240 V), 1700 W (110-120 V)
Voltage, Frequency	220-240 V~ 50-60 Hz or 110-120 V~ 50-60 Hz
No Load (Rated Load) Speed	1700 (1020) min <sup>-1</sup>
Rated Blade Diameter	320 mm
Arbor Hole Diameter	25.4 mm (1")
Max. Cutting Depth	128 mm (121 mm on Guide Rail)
Soft Start & Overload Protection	With
Dimensions (LxWxH)	500 x 342 x 355 mm
Weight	8.4 kg (18.5 lb)
Characteristics / Certification	

# DRC355 DRY-CUT METAL SAW

Quickly cut metals such as steel, stainless, aluminum and others using 355 mm (14") TCT dry cut blades for accurate, burr-free cuts. Up to 3 times faster than conventional abrasive wheel cut-off saws. Can also perform left and right miter cuts.



Model	DRC355		
Power Input	2200 W		
Voltage, Frequency	220-240 V~ 50-60 Hz or 110-120 V~ 50-60 Hz		
No Load Speed	1300 min <sup>-1</sup>		
Rated Load Speed	780 min <sup>-1</sup>		
Rated Blade Diameter	355 mm (14")		
Max. Cutting Capacities	<b>90°</b>	Round Pipe	132 mm
		Square Stock	120 mm(W) x 120 mm(H)
		Rectangular Stock	180 mm(W) x 100 mm(H)
	Right Hand Miter		
	<b>45°</b>	Round Pipe	105 mm
		Square Stock	90 mm(W) x 90 mm(H)
		Rectangular Stock	90 mm(W) x 120 mm(H)
	Left Hand Miter		
	<b>25°</b>	80 mm(W) x 120 mm(H)	
	<b>30°</b>	90 mm(W) x 120 mm(H) C-clamp required	
	<b>35°</b>	80 mm(W) x 120 mm(H) C-clamp required	
	<b>45°</b>	70 mm(W) x 120 mm(H) C-clamp required	
Arbor	25.4 mm ( 1")		
Soft Start	With		
Dimensions (LxWxH)	680 mm x 360 mm x 580 mm		
Weight	23.5 kg (51.7 lb)		
Characteristics / Certification			



V-Jig Block



Lever Clamp

## Features

1. High-stability cast alloy base.
2. Fence with scale swivels 45° in both directions with quick detents for the popular miter angles: 0°-15°-30°-45° left and right.
3. The locking holes may be used, if desired, for extra secure fence locking.
4. Two-piece Lower Blade Guard.
5. Tool-Free Fence Lock.
6. Quick-Lock Vise with Speed Crank.
7. Chip Tray.

**Standard/ Optional Accessories See p. 127**

# Circular Saw Accessories

## CS200, CS230N Metal Cutting Circular Saws

Standard Accessories	
Side Handle	
M6 Hex Key	
Optional Accessories	Part Number
Speed Control Device	
TCT Saw Blade	See p. 128



**a** Lever Clamp

## DRC355 Dry-Cut Metal Saw

Standard Accessories	
M4 Hex Key	
M6 Hex Key	
M8 Hex Key	
Optional Accessories	Part Number
Lever Clamp	305-00179-000-002
<b>a</b> Safety Goggles	305-00056-000-001
V-Jig Block	201-0030-00902-001
<b>b</b> TCT Saw Blade	See p. 128



**b** V-Jig Block

## CS320 Metal Cutting Circular Saw

Standard Accessories	
M6 Hex Key	
Side Handle	
Optional Accessories	Part Number
TCT Saw Blades (Excellent for sandwich panel)	See p. 128
<b>a</b> Lever Clamp	305-00179-000-002
<b>c</b> Guide Rail Connector	0299-0106-00000-001
<b>d</b> Guide Rail 1400 mm	0299-0065-00164-001
<b>d</b> Guide Rail 800 mm	0299-0065-00164-002



**c** Guide Rail Connector



**d** Guide Rail

# Circular Saw Accessories

## TCT Saw Blades



TCT Saw Blades for Wood:											Part Number
Application	Dia. (mm)	Kerf. (mm)	Bore (mm)	Teeth	Plate (mm)	Hardness HRA	Carbide (mm)		Hook Angle	Grind	
							Thick	Length			
DS1600	160	2.8	20	28	2.0	92	2	6.5	0°	ATB	305-00036-000-003
GP255, GP255S	255	2.6	25.4	40	1.8	92	1.6	5.5	20°	ATB	305-00036-000-016
GP255, GP255S	255	2.8	30	40	1.8	92	1.6	5.5	0°	ATB	305-00036-000-017

TCT Saw Blades for Aluminium:											Part Number
Application	Dia. (mm)	Kerf. (mm)	Bore (mm)	Teeth	Plate (mm)	Hardness HRA	Carbide (mm)		Hook Angle	Grind	
							Thick	Length			
DRC355	355	2.4	25.4	80	2.0	91	1.9	6.2	0°	TCG	305-00036-000-020
GP255, GP255S	255	2.6	25.4	100	1.8	91	1.6	5.5	20°	TCG	305-00036-000-058
GP255, GP255S	255	2.6	30	100	1.8	91	1.6	5.5	0°	TCG	305-00036-000-066

TCT Saw Blades for Steel:											Part Number
Application	Dia. (mm)	Kerf. (mm)	Bore (mm)	Teeth	Plate (mm)	Hardness HRA	Carbide (mm)		Hook Angle	Grind	
							Thick	Length			
CS200	203	2.0	20	40	1.6	90.8	1.6	5.5	0°	TCG	305-00036-000-008
CS230N	230	2.0	25.4	48	1.6	90.8	1.6	5.5	0°	TCG	305-00036-000-029
CS320	320	2.2	25.4	80	1.8	90.8	1.9	6.2	0°	TCG	305-00036-000-054
DRC355	355	2.4	25.4	80	2.0	90.8	1.9	6.2	0°	TCG	305-00036-000-001

TCT Saw Blades for Stainless Steel:											Part Number
Application	Dia. (mm)	Kerf. (mm)	Bore (mm)	Teeth	Plate (mm)	Hardness HRA	Carbide (mm)		Hook Angle	Grind	
							Thick	Length			
CS200	203	1.8	20	52	1.4	90.8	1.6	5.5	7°	TCG	305-00036-000-037
CS230N	230	1.8	25.4	60	1.4	90.8	1.6	5.5	10°	TCG	305-00036-000-039
DRC355	355	2.4	25.4	90	2.0	90.8	1.9	6.2	10°	TCG	305-00036-000-021

**Note: Tooth Grind Patterns**

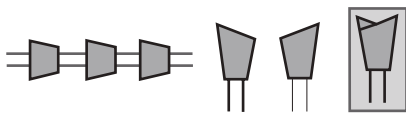

**ATB** (Alternate Top Bevel)  
Ideal for cross cutting and ripping in wood

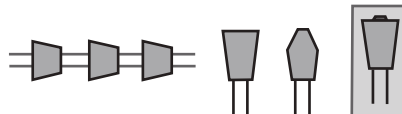

**TCG** (Triple Chip Grind)  
Ideal for metal cutting blades. Gives long sharp life in hard materials. The pointed tooth cuts narrow kerf, then the flat-top raker tooth widens the kerf and clears out chips.

# T14 TAPPER

A convenient tool for quickly tapping a series of through holes or blind holes up to M16 (5/8"). The auto-reverse gearbox mechanism makes tapping a super fast operation.



## Features

1. 2-Jaw Universal Tapping Chuck is self-centering and grips any size tap from M6 up to M16.
2. Unique, purpose-built gearbox makes tapping fast, efficient, and uniquely controllable. Press down for low-gear clockwise rotation. Pull back for high-gear counterclockwise rotation. Neutral in the center.
3. Ergonomic handle makes it easy to hold the tool straight.
4. Sprung Swivel Joint minimizes possibility of tap breakage.
5. Depth Stop for blind hole tapping.
6. Long Side Handle for excellent control.

Model	T14	
Power Input	450 W	
Voltage, Frequency	220-240 V~ 50-60 Hz or 110-120 V~ 50-60 Hz	
No Load (Rated Load) Speeds	Forward	280 (182) min <sup>-1</sup>
	Reverse	680 (442) min <sup>-1</sup>
Tapping Capacity	Steel	14 mm (9/16")
	Aluminum	16 mm (5/8")
Dimensions (LxWxH)	400 x 80 x 200 mm	
Weight	2.7 kg (5.9 lb) (Not including side handle 0.45 kg (1lb))	
Characteristics / Certification		

Standard Accessories
Side Handle
M4 Hex Key
Depth Stop
Optional Accessories
a Safety Clutch

# EB6T ELECTRIC BEVELER

Shape beveler for 45 degree bevels with up to 6 mm chamfer height. Excellent for following curved shapes, beveling cut-outs and countersinking holes over 30 mm.

Uses 3 standard square carbide inserts. Can also perform radiused edges with optional inserts and 30 degree bevels with optional tool holder.



**OPTIONAL ACCESSORIES:**

Replacement Carbide Inserts (Box of 10)



- Straight Bevel
- R2.5 Radius
- R3.5 Radius
- R4 Radius

Optional Radius Tool Holder

## Features

1. Motor with variable constant speed electronics for consistent surface results.
2. Variable Speed Wheel for setting the best speed with different materials.
3. Square Carbide Inserts. 3 Indexable square carbide inserts: ISO SEMT13T3.
4. Tool-Free Bevel Height Setting with Micrometer Scale.
5. Bevel Height Scale.
6. Adjustable Dial Ring Support Deck.

**Standard/ Optional Accessories See p. 133**

Model	EB6T
Power input	1100 W
Voltage, Frequency	220-240 V~ 50-60 Hz or 110-120 V~ 50-60 Hz
*No Load Speeds	3000 - 6000 min <sup>-1</sup>
Bevel Angle	45° (optional 30°)
Max. Chamfer Height	6 mm (at 45°) / 6.1 mm (at 30°)
Max. Bevel Width	8.5 mm (at 45°) / 6.9 mm (at 30°)
Min. Ø For Inside Bevels	30 mm
Dimensions (LxWxH)	308 x 344 x 273 mm
Weight	4.5 kg (9.9 lb)
Characteristics / Certification	

\* Due to the constant speed design, the no load and the rated load speeds are roughly the same.

# EB12 ELECTRIC BEVELER

Heavy duty shape beveler for 45 degree bevels with up to 11.0 mm chamfer height. Excellent for beveling straight lines, curved shapes, cut-outs and countersinking holes over 30 mm. Uses 6 square carbide inserts. Can also perform 30 and 37.5 degree bevels with optional tool holders.



**OPTIONAL ACCESSORIES:**

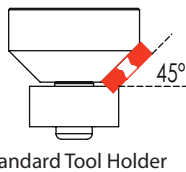
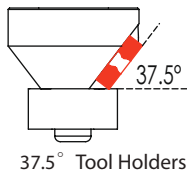
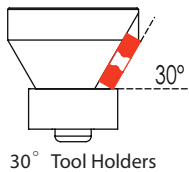

Replacement Carbide Inserts (Box of 10)



Straight Bevel

**Features**

1. Speed Control Thumb Wheel. Variable Electronic Constant Speed Circuitry maintains speed under load.
2. Precision Chamfer Height Adjustment with Dial Scale.
3. 6 Carbide Insert Tool Holder Set.

**Standard/ Optional Accessories See p. 133**

Model	EB12
Power Input	1800 W
Voltage, Frequency	220-240 V~ 50-60 Hz or 110-120 V~ 50-60 Hz
* No Load Speeds	2300 - 6500 min <sup>-1</sup>
Speed Wheel Settings	1: 2300 / 2: 2600 / 3: 3700 / 4: 4800 / 5: 5800 / 6: 6500 min <sup>-1</sup>
Bevel Angle	45°
Max. Chamfer Height	11 mm (at 45°) / 12 mm (at 37.5°) / 11.7 mm (at 30°)
Max. Bevel Width	15.6 mm (at 45°) / 15.1 mm (at 37.5°) / 13.5 mm (at 30°)
Min. Ø For Inside Bevels	30 mm
Soft Start & Overload Protection	With
Dimensions (LxWxH)	308 x 344 x 273 mm
Weight	6.4 kg (14 lb)
Characteristics / Certification	

\* Due to the constant speed design, the no load and the rated load speeds are roughly the same.

# EB24R ELECTRIC BEVELER

A plate beveler for angles from 0° to 60° with a maximum land width of 21mm with facing off and pipe beveling capability from 150 mm to 350 mm.

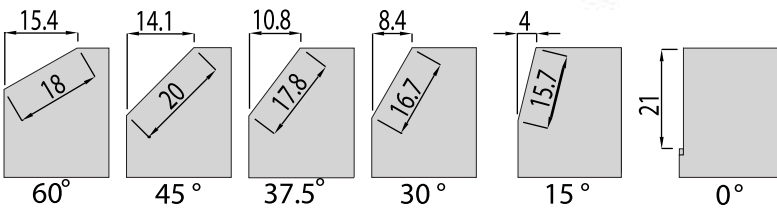

**OPTIONAL ACCESSORIES:**

Replacement Carbide Inserts (Box of 12)



Straight Bevel

Model	EB24R	
Power Output	1.1 kW (1.5 HP)	
Voltage, Frequency	220-240 V~ 50-60 Hz or 110-120 V~ 50-60 Hz	
No Load Speed	60 Hz: 3600 min <sup>-1</sup> , 50 Hz: 3000 min <sup>-1</sup>	
Angular Adjustment	Angle	Max. Bevel Width
	60°	18 mm
	45°	20 mm
	37.5°	17.8 mm
	30°	16.7 mm
	15°	15.7 mm
	0°	21 mm
Pipe beveling	150-350 mm (Standard), 300-600 mm (Optional)	
Dimensions (LxWxH)	475 x 296 x 247 mm	
Weight	19.3 kg (42.5 lb)	
Characteristics / Certification		

**Features**

1. AC Induction Motor for steady speed, low noise, and long life.
2. Tool holder with 12 carbide inserts (ISO type SPKN 1203 0.8) Bevel widths on straight and round materials.
3. Angular Adjustment Screw with angular adjustment from 0-60°
4. Depth-adjuster knob.
5. Depth Lock Screw.
6. Chamfer Height Scale.
7. Rollers for smooth operation.

**Standard/ Optional Accessories See p. 133**

# Electric Beveler Accessories

## EB6T Electric Beveler

Standard Accessories	
Torx Wrench T15	
Hook Spanner Wrench	
Spindle Lock Bar	
45° Tool Holder Set	
Square Carbide Inserts x3	
Plastic Carry Case	
Optional Accessories	Part Number
30° Tool Holder Set	0299-0142-00000-008
Square Carbide Inserts (Box of 10)	305-00051-000-007
Radius 2.5 Tool Holder Set	305-00051-000-008
Radius 3.5 Tool Holder Set	305-00051-000-009
Radius 4.0 Tool Holder Set	305-00051-000-010
R2.5 mm inserts x10	0299-0142-00000-009
R3.5 mm inserts x10	0299-0142-00000-010
R4.0 mm inserts x10	0299-0142-00000-011

## EB12 Electric Beveler

Standard Accessories	
45° Tool Holder Set	
Square Carbide Inserts x6	
Torx Wrench T15	
Hex. Wrench M6	
Hook Spanner Wrench	
Spindle Lock Bar	
Plastic Carry Case	
Optional Accessories	Part Number
30° Tool Holder Set	0299-0142-00000-006
37.5° Tool Holder Set	0299-0142-00000-007
Square Carbide Inserts (Box of 10)	305-00051-000-006

## EB24R Electric Beveler

Standard Accessories	
Milling Disc	
Square Carbide Inserts x12	
L-Hex. Wrench M8	
L-Hex. Wrench M3	
M 22 Open End Wrench	
M 32 Combination Wrench	
M27 x M24 Double Open End Wrench	
Zero Degree Milling Receiver	
Bevel Milling Receiver	
Blow Molded Case	
Optional Accessories	Part Number
Large Table Plate (for pipes 300-600 mm)	302-04150-907-004
Small Table Plate (for pipes 150-350 mm)	302-04150-907-003
Replacement Carbide Inserts (Box of 12)	305-00052-000-001

# SG6 150mm STRAIGHT GRINDER

Heavy duty straight grinder with variable constant speed electronics for outstanding performance and even finish.



## ■ Polishing mode



## Features

1. Variable Electronic Constant Speed Circuitry maintains speed under load.
2. Speed Control Thumb Wheel.
3. Adjustable guard.
4. Hand Grip.
5. Taper Mandrel Arbor.

Model	SG6
Power Input	1500 W (220-240 V), 1300 W (110-120 V)
Voltage, Frequency	220-240 V~ 50-60 Hz or 110-120 V~ 50-60 Hz
* No Load Speeds	1600 - 4800 min <sup>-1</sup>
Spindle	M14 (w/ 20 mm Tool Holder)
Max. Wheel Diameter	150 mm (6")
Soft Start & Overload Protection	With
Dimensions (LxWxH)	566 x 80 x 96 mm
Weight	3.4 kg (6.6 lb)
Characteristics / Certification	

<b>Standard Accessories</b>
Face Spanner Wrench
Taper Mandrel Arbor
Wrench M17
Wrench M22
Hex Key M5
<b>Optional Accessories</b>
Wheel

\* Due to the constant speed design, the no load and the rated load speeds are roughly the same.

# WS760 WRAPAROUND TUBE SANDER / POLISHER

A specialized tool for fast and easy finishing of tube forms. Contacts up to 270 degrees of the tube at a time. Easy belt changes for different grits and grades of belt.



## Features

1. Variable Electronic Constant Speed Circuitry maintains speed under load.
2. Speed Control Thumb Wheel.
3. High stability pulleys prevent belts from coming off in operation.
4. Tool-free belt changing for quick changes between different grits.
5. Self-tensioning arm.
6. High stability drive pulley.

Model	WS760
Power Input	1200 W (220-240 V), 850 W (110-120 V)
Voltage, Frequency	220-240 V~ 50-60 Hz or 110-120 V~ 50-60 Hz
* No Load Speeds	1600 - 3200 min <sup>-1</sup>
Surface Speed	3~12 m/s
Max. Belt ( L ) x ( W )	760 mm x 40 mm
Max. Pipe Diameter	180 mm
Max. Polishing Deg.	270°
Soft Start & Overload Protection	With
Dimensions (LxWxH)	530 x 370 x 215 mm
Weight	3.1 kg (6.8 lb)
Characteristics / Certification	

Standard Accessories	Part Number
Side Handle	
Surface Conditioning Belt (40 x 760 mm)	305-00043-000-002
Sandpaper Belt x5 #120 grit (40 X 760 mm)	305-00045-000-009
Sandpaper Belt x5 #220 grit (40 X 760 mm)	305-00045-000-010
Face Spanner Wrench	
Plastic Carry Case	

\* Due to the constant speed design, the no load and the rated load speeds are roughly the same.

# DP100 DRUM SANDER / BURNISHING MACHINE

An extremely versatile linear sander / polisher system. Go all the way from rough sanding up through mirror polishing as well as create effects like brushed finishes.



## Features

1. Cast aluminum front handle bracket for better balance and stability.
2. Variable Electronic Constant Speed Circuitry maintains speed under load.
3. Inflatable rubber sanding drum conforms to the surface (pump included) Can fit:
  - Sanding sleeves in various grits
  - Fine sanding sponge sleeves
  - Surface conditioning (fleece) sleeves
4. Optional Screw Type Mounting Nut fits flush and allows the drum to go all the way into corners.
5. Tool-Free Arbor.
6. Speed Control Thumb Wheel.

Model	DP100
Power Input	1200 W (220-240 V), 850 W (110-120 V)
Voltage, Frequency	220-240 V~ 50-60 Hz or 110-120 V~ 50-60 Hz
* No Load Speeds	1500 - 2800 min <sup>-1</sup>
Max. Wheel Diameter	100 mm
Max. Wheel Width	100 mm
Arbor	19 mm double keyed x 100 mm long
Soft Start & Overload Protection	With
Dimensions (LxWxH)	394 x 198 x 195 mm
Weight	3.5 kg (7.7 lb)
Characteristics / Certification	

\* Due to the constant speed design, the no load and the rated load speeds are roughly the same.

## Surface Conditioning Flap Wheel

## Drive Pulley for Belts



### ■ Inflatable Rubber Sanding Drum



**a** Inflatable Rubber Sanding Drum



**b** Air Pump



**c** Sandpaper Sleeve



**h** Surface Conditioning Flap Wheel



**i** Arbor Spacer Discs

### ■ Drive Pulley for Belts

(All belts with 45 degree slit for opening and closing)



**d** Drive Pulley for Belts



**e** Sandpaper Belt



**f** Surface Conditioning Belt



**g** Hook & Loop Belt Closing Straps

### Standard Accessories

Plastic Carry Case

<b>a</b> Inflatable Rubber Sanding Drum	0299-0016-00000-001
<b>b</b> Air Pump	305-00041-004-001
<b>c</b> Surface Conditioning Sleeve (100 x 292 mm)	305-00043-000-001
<b>c</b> Sandpaper Sleeve #60	305-00045-000-001
<b>c</b> Sandpaper Sleeve #100	305-00045-000-002
<b>c</b> Sandpaper Sleeve #180	305-00045-000-003
<b>d</b> Drive Pulley for Belts	303-01073-005-001
<b>e</b> Sandpaper Belt #120 Grit (40 x 600 mm)	305-00048-000-001
<b>f</b> Surface Conditioning Belt (40 x 600 mm)	305-00046-000-001
<b>g</b> Hook & Loop Belt Closing Straps (30 x 700 mm)	305-00049-000-001
<b>h</b> Surface Conditioning Flap Wheel (100 x 100 x 19 mm)	305-00042-000-001
<b>i</b> Arbor Spacer Discs (35 x 19 x 5 mm)	305-01021-004-002

# DB32 DIGITAL BENDING MACHINE

A portable tubing bender with unique digital LCD degree display. Preset the desired angle up to 190° in tubing up to 1-3/8". The digital control allows fine tuning of the bend and repeatable results.

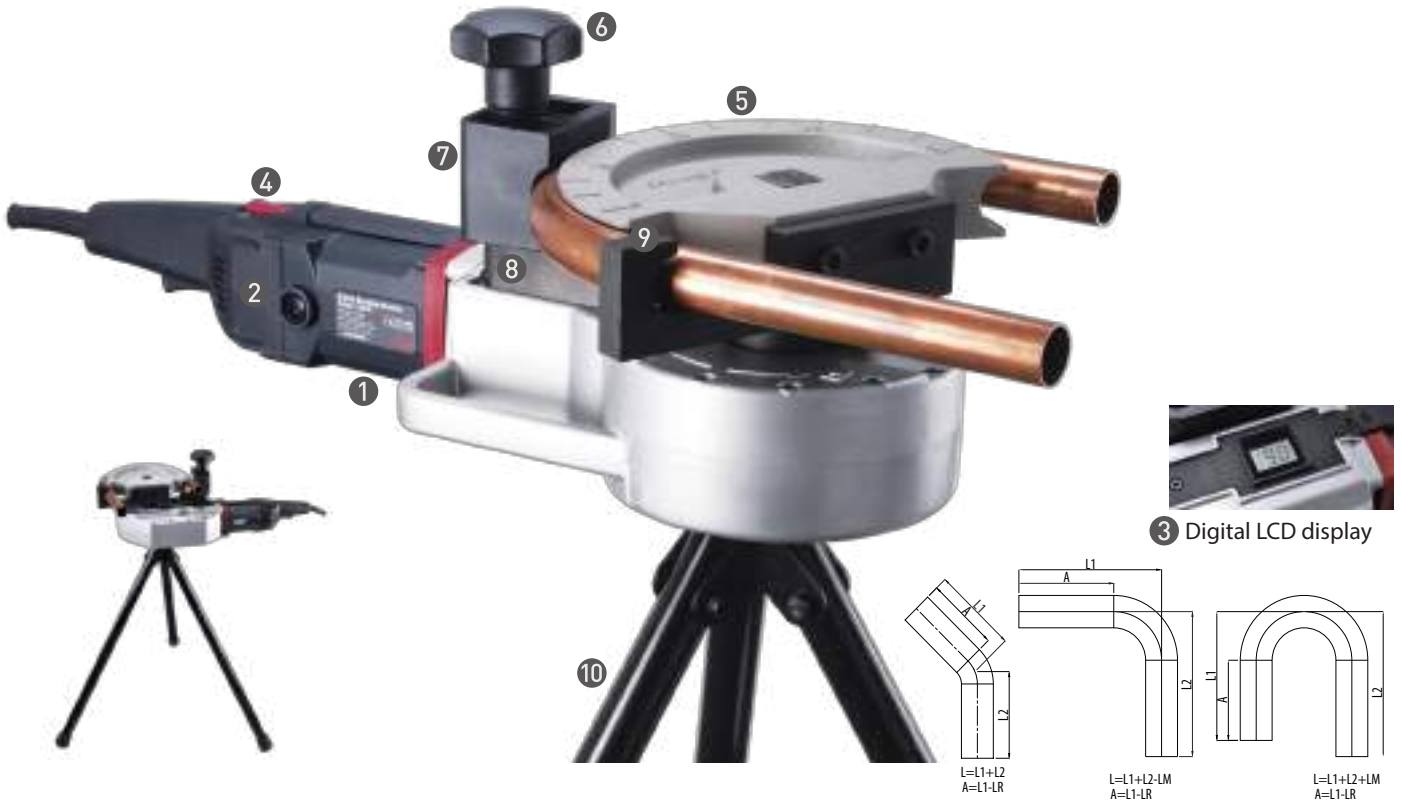

**OPTIONAL ACCESSORIES:**



Bending Former & Bending Shoe

Bending Former		Part Number	Bending Shoe		Part Number
1.	5/8" R=4D	0299-0045-00000-001	5/8"	303-01220-004-001	
2.	3/4" R=4D	0299-0045-00000-002	3/4"	303-01220-004-002	
3.	7/8" R=4D	0299-0045-00000-003	7/8"	303-01220-004-003	
4.	1" R=4D	0299-0045-00000-004	1"	303-01220-004-004	
5.	1-1/8" R=4D	0299-0045-00000-005	1-1/8"	303-01220-004-005	
6.	1-1/4" R=4D	0299-0045-00000-006	1-1/4"	303-01220-004-006	
7.	1-3/8" R=3.6D	0299-0045-00000-010	1-3/8"	303-01220-004-008	

**Features**

- 1700 W motor with constant speed.
- Thumbwheel for setting the desired degree of bend.
- Digital LCD display.
- Easy to use reversing switch.
- Bending Former with gradation markings.
- Shoe pivot bolt.
- Bending shoe.
- Shoe bracket.
- Driver hook.
- Tripod.

Model	DB32
Power Input	1700 W
Voltage, Frequency	220-240 V~ 50-60 Hz or 110-120 V~ 50-60 Hz
No Load Speed	3.5 min <sup>-1</sup>
Max. Capacity	1-3/8"
Soft Start	With
Dimensions (LxWxH)	630 x 230 x 183 mm
Weight	14 kg (30.9 lb)
Characteristics / Certification	

Standard Accessories		Part Number
Tripod		0299-0044-00000-001
Velcro Strap		305-00150-000-001
Optional Accessories		
Bending Former & Bending Shoe		

Size	Material	R(mm)	45°		90°		180°	
			L <sub>x</sub> (mm)	L <sub>m</sub> (mm)	L <sub>x</sub> (mm)	L <sub>m</sub> (mm)	L <sub>x</sub> (mm)	L <sub>m</sub> (mm)
5/8"(15.88mm)		64	25	-	69	35	66	52
3/4"(19.05mm)		77	30	-	79	35	79	63
7/8"(22.22mm)		88	35	-	92	48	92	96
1"(25.4mm)		102	39	-	103	58	103	112
1-1/8"(28.58mm)		115	45	-	118	55	118	118
1-1/4"(31.75mm)		127	50	-	130	71	130	135
1-3/8"(34.9mm)		123	48	-	126	51	126	149

# HC127 HOLE CUTTING DRILL





A convenient tool for quickly drilling perfectly centered and perpendicular holes up to 127 mm diameter in pipes from 1-1/4" to 8-1/4". Excellent for installing mechanical tee fittings, pipe saddles, etc.



## Features

1. Good balance for carrying.
2. The quick adjustable tool-free Crank Handle can mount on either side.
3. Chain Vise Clamping System quickly mounts machine onto 1-1/4" to 8-1/4" diameter pipe. (32 mm-203 mm)
4. Built-in Bubble Levels for multiple hole alignment.

Model	HC127
Power Input	1100 W
Voltage, Frequency	220-240 V~ 50-60 Hz or 110-120 V~ 50-60 Hz
No Load (Rated Load) Speed	130 (85) min <sup>-1</sup>
Max. Cutting Capacity (Hole Cutter)	127 mm
Pipe Mounting Capacity	32 mm-203 mm (600 mm w/ optional Long Chain Set)
Drill Chuck Capacity	16 mm (5/8") shank
Over Load Protection	With
Weight	14.5 kg ( 31.9 lb ) Not including Crank Handle

Characteristics / Certification     

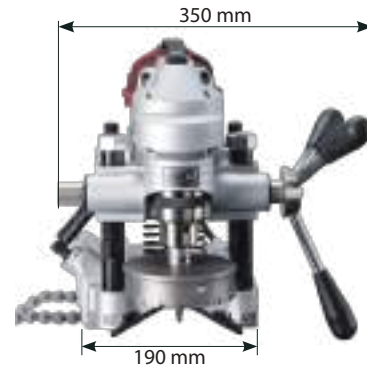
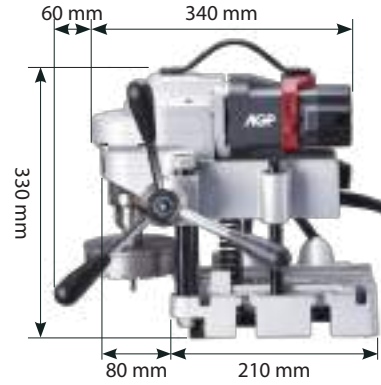

## TCT HOLE CUTTERS (FOR MODEL HC127) 25 mm DEPTH



Diameter (mm)	Part Number
60	305-03346-000-037
65	305-03346-000-038
70	305-03346-000-039
75	305-03346-000-040
80	305-03346-000-041
85	305-03346-000-042
90	305-03346-000-043
95	305-03346-000-044
100	305-03346-000-045
105	305-03346-000-046
110	305-03346-000-047
115	305-03346-000-048
120	305-03346-000-049
125	305-03346-000-050
127	305-03346-000-051

**\*Note:** Bi-metal hole saws or twist drills recommended for sizes below 60 mm

Standard Accessories	
16 mm (5/8") Chuck & Chuck Key	
Crank Handle Set	
Optional Accessories	Part Number
Long Chain Set (for pipes up to 600 mm diameter)	305-00035-000-002

# RS26 RECIPROCATING SAW FOR PIPES

A reciprocating saw purpose-built for making perfectly square cuts on pipes up to 8" diameter. Orbital reciprocating mechanism and variable constant speed allow the fastest possible results.



Optional **2-in-1 vise**. On one side there is a **chain clamp** for 1/2" up to 8" pipes. On the other side is a **Quick-Release Vise**. For pipe cutting, the vise gives 4 times the leverage and a perfect 90 degree cut.



Quick-Release Vise side of the optional 2-in-1 Vise for smaller diameters.



Chain Vise side of the optional 2-in-1 Vise for larger diameters.

## Features

1. High-impact reciprocating mechanism with aggressive orbital action.
2. Speed Control Thumb Wheel.
3. Electronic Constant Speed Circuitry maintains speed under load.
4. Soft-grip boot on gearcase.
5. Ratchet Handle for quick, tool-free clamping.
6. Quick-Release Chain Vise. (Standard)

Model	RS26
Power Input	1500 W
Voltage, Frequency	220-240 V~ 50-60 Hz or 110-120 V~ 50-60 Hz
* No Load Speeds	1000 - 2100 min <sup>-1</sup>
Stroke	26 mm (1")
Max. Capacity	203 mm (8")
Speed Control	With
Soft Start & Overload Protection	With
Dimensions (LxWxH)	491 x 94 x 108 mm
Weight	4.35 kg (10 lb)
Characteristics / Certification	

### OPTIONAL ACCESSORIES:

Blade 290 mm



### Standard Accessories

Hex. Wrench M4

Quick-Release Chain Vise

Optional Accessories	Part Number
2-in-1 Vise	0299-0013-00004-001
Blade 290 mm	305-00036-000-033

\* Due to the constant speed design, the no load and the rated load speeds are roughly the same.

# RS130B RECIPROCATING SAW

A general purpose reciprocating saw with variable constant speed motor.



5 Pivoting shoe plate

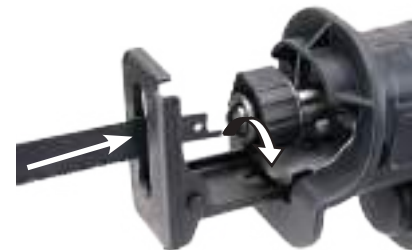

4 Tool-free

## Features

1. High-impact reciprocating mechanism.
2. Speed Control Thumb Wheel.
3. Electronic Constant Speed Circuitry maintains speed under load.
4. Tool-free blade change.
5. Pivoting shoe plate.

Model	RS130B
Power Input	1600 W (220 V), 1300 W (110 V)
Voltage, Frequency	220-240 V~ 50-60 Hz or 110-120 V~ 50-60 Hz
* No Load Speeds	1000 - 2800 min <sup>-1</sup>
Stroke	26 mm (1")
Max. Capacity	130 mm
Speed Control	With
Soft Start & Overload Protection	With
Quick Release Saw Blade Replacing System	With
Dimensions (LxWxH)	470 x 155 x 97 mm
Weight	3.70 kg (8.14 lb)

## OPTIONAL ACCESSORIES:

Blade 190 mm

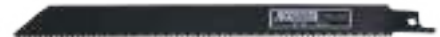

### Standard Accessories

Hex. Wrench M6

Optional Accessories	Part Number
Blade 190 mm	305-00036-000-024

Characteristics / Certification

\* Due to the constant speed design, the no load and the rated load speeds are roughly the same.

# DS1600 PLUNGE CUT CIRCULAR SAW

160 mm plunge cut saw with 55 mm depth of cut. Outstanding accuracy and control when used in conjunction with the optional guide rail.



Aluminum Guide Rail

## Features

1. Zero Degree Bevel Fine Adjustment.
2. Guide Clearance Adjustors.
3. Precise Bevel Angle Indication.
4. Onboard Hex Wrench Storage.
5. Adjustable Depth Stop.

Model	DS1600
Power Input	1150 W
Voltage, Frequency	220-240 V~ 50-60 Hz or 110-120 V~ 50-60 Hz
No Load Speed	5500 min <sup>-1</sup>
Bevel Capability	0° to 45°
Max. Blade Diameter	160 mm (6-1/4")
Arbor	20 mm
Max. Depth (Straight)	55 mm (2-3/16")
Max. Depth (45°)	35 mm (1-3/4")
Soft Start & Overload Protection	With
Dimensions (LxWxH)	322 x 228 x 266 mm
Weight	4.8 kg (10.6 lb)
Characteristics / Certification	



Guide Rail Connector



Lever Clamp

### Standard Accessories

- M5 Hex Key
- 160 mm 28T TCT Saw Blade  
(See p. 122)

Optional Accessories	Part Number
Guide Rail (800 mm)	0299-0065-00149-005
Guide Rail (1400 mm)	0299-0065-00149-006
Guide Rail Connector	0299-0106-00000-001
Lever Clamp	305-00179-000-001

# AIRLESS PAINT SPRAYERS



		T328	EC021	PM021LF	PM021	PM025	PM031	PM039	PE048
<b>Wood Interior</b>	Lacquer	✓	✓	✓	✓	✓	✓	✓	✓
	Varnish	✓	✓	✓	✓	✓	✓	✓	✓
	Stain	✓	✓	✓	✓	✓	✓	✓	✓
	Sealer	✓	✓	✓	✓	✓	✓	✓	✓
	Enamel Paint	✓	✓	✓	✓	✓	✓	✓	✓
<b>Ceiling</b>	High Build Coating		✓	✓	✓	✓	✓	✓	✓
<b>Wood Exterior &amp; Masonry</b>	Exterior Stain		✓	✓	✓	✓	✓	✓	✓
	Vinyl		✓	✓	✓	✓	✓	✓	✓
	Latex		✓	✓	✓	✓	✓	✓	✓
	Acrylic		✓	✓	✓	✓	✓	✓	✓
	Alkyd		✓	✓	✓	✓	✓	✓	✓
	Elastomeric						✓	✓	✓
	Block Filler						✓	✓	✓
Elastic Cement							✓	✓	
<b>Drywall</b>	Plaster						✓	✓	✓
<b>Structural Steel</b>	Heavy Coating		✓	✓	✓	✓	✓	✓	✓

# HA10 HIGH PRESSURE DISINFECTANT SPRAYER

A high performance high pressure airless sprayer for the fastest possible application of disinfectants. Equipped with accessories chosen for water-based disinfectants.



## Features

1. High performance piston pump with long life packings.
2. Flexible Suction Hose.
3. Mechanical Pressure Control System.
4. DC motor for high torque.

**\* High-Pressure Hose not included.  
Standard/ Optional Accessories See p. 153**

Model	HA10
Motor Type	DC Motor, Fan-Cooled
Power Input	700 W
Power Output	0.46 kW (0.57 HP)
Voltage, Frequency	220-240 V~ 50-60 Hz or 110-120 V~ 50-60 Hz
Max Tip Size	0.010"
Max Flow	1.9 l/min (0.50 gpm)
Max Pressure	96 bar (1400 psi)
Dimensions (LxWxH)	360 x 250 x 400 mm
Weight	11.0 kg (24.3 lb)
Characteristics / Certification	CECB

# EC021 PISTON PUMP AIRLESS PAINT SPRAYER

The light, compact airless sprayer with mechanical pressure control for up to 0.021" tips for a wide range of paint types.



6.2L Hopper Kit



The optional Pump Filter gives additional filtration for longer component life



The optional Pressure Gauge allows the operator to see the exact pressure at the pump

## Features

1. DC motor for high torque.
2. Mechanical Pressure Control System.
3. High performance piston pump with long life packings.
4. Drip Cup for mess-free placement of suction tube.
5. Flexible Suction Hose.

**\* High-Pressure Hose not included. Standard/ Optional Accessories See p. 153**

Model	EC021
Motor Type	DC Motor, Fan-Cooled
Power Input	700 W
Power Output	0.46 kW (0.57 HP)
Voltage, Frequency	220-240 V~ 50-60 Hz or 110-120 V~ 50-60 Hz
Max Tip Size	0.021"
Max Flow	1.9 l/min (0.50 gpm)
Max Pressure	207 bar (3,000 psi)
Dimensions (LxWxH)	360 x 250 x 400 mm
Weight	11.0 kg (24.3 lb)
Characteristics / Certification	CE CB 

# PM021LF & PM025LF PISTON PUMP AIRLESS PAINT SPRAYERS

Low frame airless sprayers with digital electronic pressure control for a wide range of paint types.  
 PM021LF: 0.021" tips / PM025LF: 0.025" tips.



## Features

1. Totally enclosed, fan-cooled, DC motor for high torque and long life.
2. Built-in toolbox for holding extra tips and filters.
3. High performance piston pump with long-life packings.
4. Quick-response electronic pressure control with LCD screen. (choose BAR or PSI)
5. Drip Cup for mess-free placement of suction tube.
6. Pump Filter.
7. Flexible Suction Hose.

**\* High-Pressure Hose not included.  
 Standard/ Optional Accessories See p. 153**

Model	PM021LF	PM025LF
Motor Type	DC Motor (TEFC)	
Power Input	1000 W	1300 W
Power Output	0.68 kW (0.9 HP)	0.88 kW (1.2 HP)
Voltage, Frequency	220-240 V~ 50-60 Hz or 110-120 V~ 50-60 Hz	
Max Tip Size	0.021"	0.025"
Max Flow	2.1 l/min (0.55 gpm)	2.7 l/min (0.71 gpm)
Max Pressure	207 bar (3,000 psi)	
Control	Digital	
Overload Protection	With	
Dimensions (LxWxH)	420 x 300 x 550 mm	
Weight	23.4 kg (51.6 lb)	23.5 kg (51.8 lb)
Characteristics / Certification		

# PM021, PM025 PISTON PUMP AIRLESS PAINT SPRAYERS

High frame airless sprayers with digital electronic pressure control.



## Features

1. Totally enclosed, fan cooled, DC motor for high torque and long life.
2. Quick-response electronic pressure control with LCD screen. (BAR or PSI)
3. High performance piston pump with long-life packings.
4. Built-in Toolbox for holding extra tips and filters.
5. Hooks for convenient hose storage.
6. Gear-driven Pump.
7. Pump Filter.
8. Retractable handle.

**\* High-Pressure Hose not included.  
Standard/ Optional Accessories See p. 153**

Model	PM021	PM025
Motor Type	DC Motor (TEFC)	
Power Input	1000 W	1300 W
Power Output	0.68 kW (0.9 HP)	0.88 kW (1.2 HP)
Voltage, Frequency	220-240 V~ 50-60 Hz or 110-120 V~ 50-60 Hz	
Max Tip Size	0.021"	0.025"
Max Flow	2.1 l/min (0.55 gpm)	2.7 l/min (0.71 gpm)
Max Pressure	207 bar (3,000 psi)	
Control	Digital	
Overload Protection	With	
Dimensions (LxWxH)	515 x 530 x 795 mm	
Weight	33 kg (72.6 lb)	33 kg (72.6 lb)
Characteristics / Certification		

# PM031 PISTON PUMP AIRLESS PAINT SPRAYERS

Heavy-duty airless sprayer with brushless motor and digital electronic pressure control for up to 0.031" tips. Multiple gun capability.



## Features

1. Powerful Brushless Motor.
2. High performance piston pump with long-life packings.
3. Quick-response electronic pressure control with LCD screen. (BAR or PSI)
4. Built-in Toolbox for holding extra tips and filters.
5. Hooks for convenient hose storage.

**\* High-Pressure Hose not included. Standard/ Optional Accessories See p. 154**

Model	PM031
Motor Type	Brushless DC Motor
Power Output	1.5 kW (2.0 HP)
Voltage, Frequency	220-240 V~ 50-60 Hz or 110-120 V~ 50-60 Hz
Max Tip Size	0.031"
Max Flow	4.17 l/min (1.1 gpm)
Max Pressure	227 bar (3,300 psi)
Control	Digital
Overload Protection	With
Dimensions (LxWxH)	670 x 580 x 810 mm
Weight	59.0 kg (130.1 lb)
Characteristics / Certification	

# PM039 PISTON PUMP AIRLESS PAINT SPRAYERS





Heavy-duty airless sprayer with brushless motor and digital electronic pressure control for up to 0.039" tips. Multiple gun capability.



## Features

1. Powerful Brushless Motor.
2. Special Plaster-Type Suction Assembly for plaster and other heavy materials.
3. Quick-response electronic pressure control with LCD screen. (BAR or PSI)
4. High performance piston pump with long-life packings.
5. Built-in Toolbox for holding extra tips and filters.
6. Plaster Tank (Optional) The frames of both units interlock with special hooks for a neat and compact assembly. Includes special coupling adapter, wringer and scraper plate.
7. Ball Type Priming Valve.
8. Special hooks for coupling with plaster tank.
9. Coupling Adapter.

**\* High-Pressure Hose not included.  
Standard/ Optional Accessories See p. 154**

Model	PM039
Motor Type	Brushless DC Motor
Power Output	1.8 kW (2.4 HP)
Voltage, Frequency	220-240 V~ 50-60 Hz or 110-120 V~ 50-60 Hz
Max Tip Size	0.039"
Max Flow	6.4 l/min (1.7 gpm)
Max Pressure	227 bar (3,300 psi)
Control	Digital
Overload Protection	With
Dimensions (LxWxH)	670 x 580 x 810 mm
Weight	61.1 kg (134.7 lb)
Characteristics / Certification	   

# PE048 ENGINE AIRLESS PAINT SPRAYERS

Heavy-duty airless sprayer with petrol (gasoline) engine and digital electronic pressure control for up to 0.048" tips. Multiple gun capability. Excellent for heavy materials and long hose runs.



## Features

- 1. 6.5 HP Honda Engine for independent operation and plentiful power.
- 2. Electronic Pressure Control with LCD display for Pressure, Working Hours, and Diagnostic Messages.
- 3. Control System includes Auto Stop Function when paint is used up.
- 4. High-Durability Electromechanical Clutch.
- 5. Hours Display Button. (on back of control box)
- 6. High performance piston pump with long-life packings.
- 7. Built-In Tool Box for holding, tools, extra tips, and filter.
- 8. Quick-Release Pump for easy maintenance.
- 9. Large pneumatic wheels and sturdy frame.
- 10. Flexible Suction Hose.

\* **High-Pressure Hose not included.**

**Standard/ Optional Accessories See p. 154**

Model	PE048		
Engine Type	Honda GX200, Four Stroke Petrol (Gasoline)		
Power Rating	6.5 HP		
Max. Tip Size (1 Gun)	0.048"	Max. Tip Size (3 Guns)	0.027"
Max. Tip Size (2 Guns)	0.035"	Max. Tip Size (4 Guns)	0.023"
Minimum Tip Size	0.023"		
Max Flow	8.3 l/min (2.2 gpm)		
Max Pressure	227 bar (3,300 psi)		
Pressure Control	Digital		
Max. Hose Length	100 m ( 300' )		
Dimensions (LxWxH)	670 x 580 x 810 mm		
Weight	74.5 kg (164.2 lb)		

# T328 HVLP TURBINE PAINT SPRAYER

High Volume, Low Pressure 3-stage turbine with up to 2800 l/min air flow rate for fine finish applications.



**OPTIONAL ACCESSORIES:**



250 ml Plastic Cup for Gun



Radiator Kit







Needle Nozzle Set

**Features**

1. 3-Stage turbine with high output motor.
2. Infinitely variable speed control for fine-tuning airflow.
3. Non-bleeder HVLP Gun.
4. Easy access filter compartment.
5. Convenient storage space.
6. Carry handle at the balance point of the machine.
7. Air hose with quick-release couplings on both ends.

**Standard/ Optional Accessories See p. 155**

Model	T328
Power Input	1400 W
Voltage, Frequency	220-240 V~ 50-60 Hz or 110-120 V~ 50-60 Hz
Turbine	3 Stage
Airflow	2800 l/min
Max. Working Pressure	0.41 bar (6 psi)
Soft Start	With
Dimensions (LxWxH)	325 x 250 x 325 mm
Weight	8.5 kg (18.7 lb)
Characteristics / Certification	   

# Sprayer Accessories

## HA10 High Pressure Disinfectant Sprayer

Standard Accessories	
7/8" Spray Gun	
7/8" Tip Guard	
510 Tip	
15" (380 mm) Extension	
Optional Accessories	Part Number
Extensions	See p. 155



**a** 6.2L Hopper Kit

## EC021 Piston Pump Airless Paint Sprayer

Standard Accessories	
Tommy Bar	
Flexible Suction Hose	
Throat Seal Oil (100 ml Squeeze Bottle)	
Optional Accessories	Part Number
Pump Filter Set	See p. 155
Replacement Pump Filter Screen	
Gun - (Not incl. Tip Guard or Tip)	See p. 155
<b>a</b> 6.2L Hopper Kit	0299-0097-00000-002
<b>b</b> Pressure Gauge	0299-0181-00000-001



**b** Pressure Gauge

## PM021LF, PM025LF Piston Pump Airless Paint Sprayers

Standard Accessories	
Gun With Tip Guard and Tip (0.017")	
Pump Filter w/ One Each 60 & 100 Mesh	
Special Multi-Purpose Wrench	
Flexible Suction Hose	
Throat Seal Oil (100 ml Squeeze Bottle)	
Tommy Bar	
Optional Accessories	Part Number
Pump Filter w/ 30 Mesh	See p. 155

## PM021, PM025 Piston Pump Airless Paint Sprayers

Standard Accessories	
Gun With Tip Guard and Tip (0.017")	
Pump Filter w/ One Each 60 & 100 Mesh	
Special Multi-Purpose Wrench	
Rigid Suction Tube	
Throat Seal Oil (100 ml Squeeze Bottle)	
Tommy Bar	
Optional Accessories	Part Number
Pump Filter w/ 30 Mesh	See p. 155

# Sprayer Accessories

## PM031 Piston Pump Airless Paint Sprayers

Standard Accessories	
Gun With Tip Guard and Tip (0.031")	
Inlet strainer 20 Mesh	
Pump Filter w/ One Each 60 & 100 Mesh	
Special Multi-Purpose Wrench	
Throat Seal Oil (100 ml Squeeze Bottle)	
Tommy Bar	
Optional Accessories	Part Number
Pump Filter w/ 30 Mesh	See p. 155



**d** Inlet Strainer 20 Mesh



**e** Inlet Strainer 16 Mesh

## PM039 Piston Pump Airless Paint Sprayers

Standard Accessories	
Gun With Tip Guard and Tip (0.031")	
Inlet strainer 16 Mesh	
<b>d</b>	Pump Filter w/ One Each 60 & 100 Mesh
Special Multi-Purpose Wrench	
Throat Seal Oil (100 ml Squeeze Bottle)	
Tommy Bar	
Optional Accessories	Part Number
Pump Filter w/ 30 Mesh	See p. 155

## PE048 Engine Airless Paint Sprayers

Standard Accessories	
Gun With Tip Guard and Tip (0.035")	
<b>e</b>	Inlet strainer 8 Mesh
Pump Filter w/ One Each 60 & 100 Mesh	
Special Multi-Purpose Wrench	
Throat Seal Oil (100 ml Squeeze Bottle)	
Tommy Bar	
Optional Accessories	Part Number
Pump Filter w/ 30 Mesh	See p. 155

# T328 HVLP Turbine Paint Sprayer

Standard Accessories		Part Number
<b>a</b>	Gun with 1.3mm Needle Nozzle Set	305-00172-000-001
Optional Accessories		Part Number
<b>b</b>	Needle Nozzle Sets(0.5 mm)	305-00167-000-001
<b>b</b>	Needle Nozzle Sets(0.8 mm)	305-00167-000-002
<b>b</b>	Needle Nozzle Sets(1.0 mm)	305-00167-000-003
<b>b</b>	Needle Nozzle Sets(1.2 mm)	305-00167-000-004
<b>b</b>	Needle Nozzle Sets(1.3 mm)	305-00167-000-005
<b>b</b>	Needle Nozzle Sets(1.8 mm)	305-00167-000-006
<b>b</b>	Needle Nozzle Sets(2.0 mm)	305-00167-000-007
<b>b</b>	Needle Nozzle Sets(2.5 mm)	305-00167-000-008
<b>c</b>	Radiator Kit	0299-0107-00000-001
<b>d</b>	250 ml Plastic Cup for Gun	305-00299-000-001



**Air Hose**



**a HVLP Gun Set**



**b Needle Nozzle Set**



**c Radiator Kit**



**d 250 ml Plastic Cup**

## Sprayer Accessories



**f Tip Extensions**



**g Pump Filter**



**h Gun 7/8"**



**i Tip Guard 7/8"**



**j Reverisble Tip, with Seat**

Tip Extensions	Part Number	Tip Extensions	Part Number
<b>f</b> Tip Extensions 11/16" x 15"(L)	0201-0096-00906-001	Tip Extensions 7/8" x 15"(L)	0201-0096-00906-002
<b>f</b> Tip Extensions 11/16" x 30"(L)	0201-0096-00906-003	Tip Extensions 7/8" x 30"(L)	0201-0096-00906-004
<b>f</b> Tip Extensions 11/16" x 60"(L)	0201-0096-00906-005	Tip Extensions 7/8" x 60"(L)	0201-0096-00906-006
Pump Filter	Part Number		
<b>g</b> Pump Filter- 30 Mesh	202-0007-00000-001		
<b>g</b> Pump Filter- 60 Mesh	202-0007-00000-002		
<b>g</b> Pump Filter-100 Mesh	202-0007-00000-003		
Gun, Tip Guard And Tips	Part Number	Gun, Tip Guard And Tips	Part Number
<b>h</b> Gun 7/8"	305-00172-000-008	Tip 521 (0.021")	305-00168-000-005
<b>i</b> Tip Guard 7/8"	0299-0050-00000-002	Tip 523 (0.023")	305-00168-000-007
<b>j</b> Reverisble Tip, with Seat		Tip 525 (0.025")	305-00168-000-008
Tip 513 (0.013")	305-00168-000-001	Tip 529 (0.029")	305-00168-000-012
Tip 215 (0.015")	305-00168-000-019	Tip 531 (0.031")	305-00168-000-009
Tip 315 (0.015")	305-00168-000-020	Tip 533 (0.033")	305-00168-000-010
Tip 515 (0.015")	305-00168-000-002	Tip 535 (0.035")	305-00168-000-006
Tip 517 (0.017")	305-00168-000-003	Tip 537 (0.037")	305-00168-000-013
Tip 519 (0.019")	305-00168-000-004	Tip 539 (0.039")	305-00168-000-014









**AGP<sup>®</sup>**



[www.agp-powertools.com](http://www.agp-powertools.com)  
2026.04