

DAVIS®

Cantina Price List

Designed by jehs+laub

Effective January 1, 2026

Updated January 16, 2026



CANTINA Series

Specifications	2
Images	3
Veneer Finishes	4
FENIX® / Standard Laminates	5
Powder Coat Finishes	6
Ordering Examples	7

FREESTANDING UNITS

BENCHES

CT-50	8
CT-66	8
CT-74	8
CT-90	8
CT-166	9
CT-190	9
CT-266	10
CT-290	10

58" WIDE L SHAPED UNITS

CT-189-58-LB	11
CT-113-58-LB	12
CT-189-58-HB	15
CT-113-58-HB	16

64" WIDE L SHAPED UNITS

CT-189-64-LB	13
CT-113-64-LB	14
CT-189-64-HB	17
CT-113-64-HB	18

U SHAPED BOOTH

CT-4000	19
CT-4001	19

MODULAR UNITS

LEGS

CT-Leg-BL	20
CT-Leg-B	20

CUSHIONS

CT-70	21
CT-71	21
CT-1170	22
CT-1171	22
CT-1172	22
CT-2170	23
CT-2171	23
CT-2172	23



BIFMA Compliant®, the commercial furniture industry's registry of standards-conforming products.

FEATURES

Legs

Powder coated steel

Glides

Bases come standard with black or grey plastic glides.

- Bases powder coated in Anthracite, Beige Arizona, Blu Fes, Blu Shaba, Bronze, Burgundy, Cacao Orinoco, Champagne, Dark Green, Grigio Antrim, Grigio Bromo, Grigio Londra, Light Anthracite, Light Bronze, Light Tan, Matte Black, Moss, Mustard, Rosso Jaipur, Verde Comodoro, Sand, Steel, Teal, Terracotta, will have **black plastic glides**.

- Bases powder coated Fog, Grigio Efeso, Ice, Ivory, Light Grey, Light Sage, Light Tan, Matte Silver, Matte White, Mid Grey, Rosa, Stone and Verde Kitami, will have **grey plastic glides**.

Seat Units

Plywood frames with steel supports. Combination of molded foam and multi-density foam.

Upholstery

Davis Fabric and Leather Program COM/COL

If you are supplying the COM/COL, submit a sample before ordering for approval.

All graded in and COM/COL must be approved for use on Cantina by the Davis factory.

NOTE: Dimensions include \pm because of fabric & fabric stretch per unit.



Backless Bench



High Back Three Seater

-shown with a Riza Table and Sachet chair



U Shaped

-shown with a Riza Table

Ash Veneer



30 Vanilla Ash

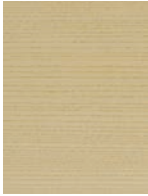

31 Natural Ash



32 Sand Ash

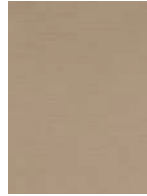

33 Toasted Ash

Oak Veneer

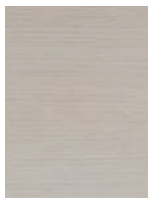

10 Alabaster
White Oak



11 Light Oak

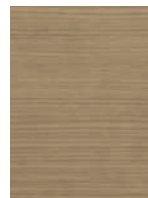

12 Golden
Oak

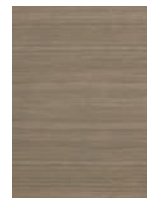

13 Harvest
Oak

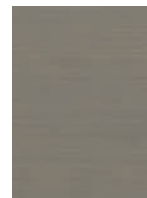

14 Slate Oak

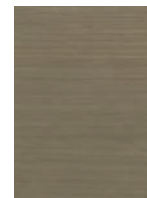

15 Mineral Grey
Oak



16 Dark Oak

Walnut Veneer



20 Clear
Walnut



21 Light Grey
Walnut

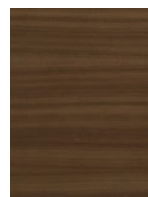

22 Classic
Walnut

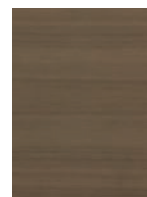

23 Mocha
Walnut

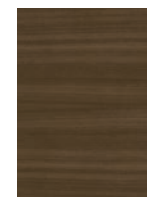

24 Midnight
Walnut

FENIX® Innovative Materials



Bianco Kos Grigio Efeso Grigio Antrim Grigio Bromo Beige Arizona Grigio Londra Cacao Orinoco Rosso Jaipur

Blu Shaba Blu Fes Verde Kitami Verde Comodoro Nero Ingo

Standard Laminates

Solids

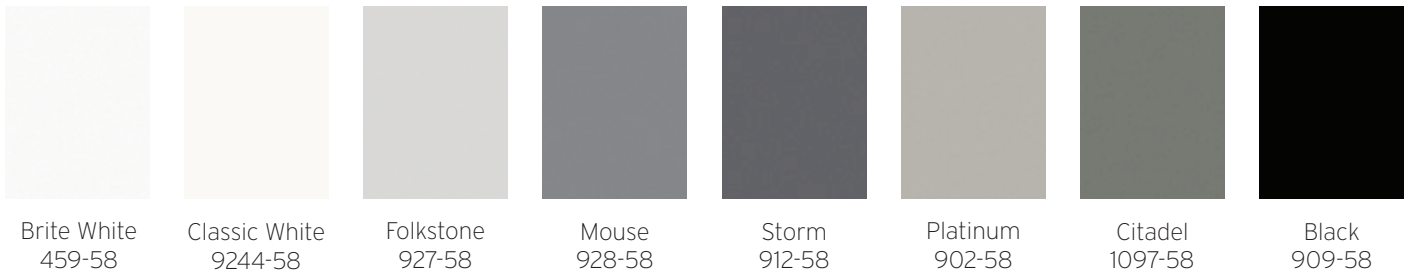

Brite White 459-58 Classic White 9244-58 Folkstone 927-58 Mouse 928-58 Storm 912-58 Platinum 902-58 Citadel 1097-58 Black 909-58

Woodgrains

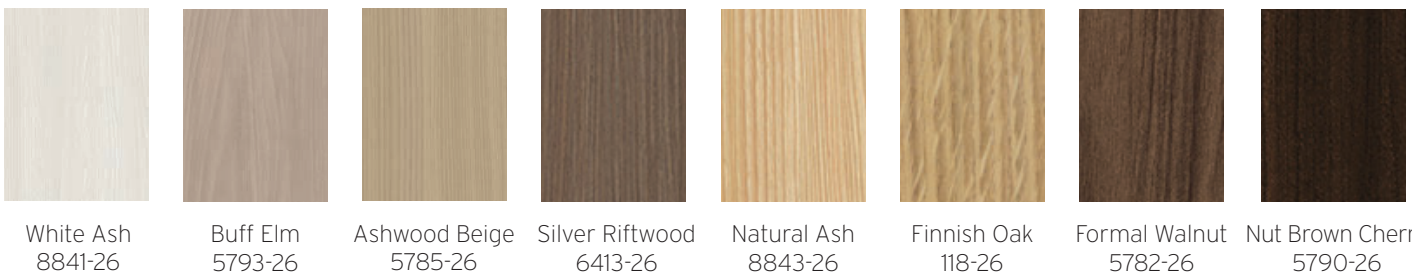

White Ash 8841-26 Buff Elm 5793-26 Ashwood Beige 5785-26 Silver Riftwood 6413-26 Natural Ash 8843-26 Finnish Oak 118-26 Formal Walnut 5782-26 Nut Brown Cherry 5790-26



Graphite Elm 5796-26

Powder Coats

Neutral Powder Coats

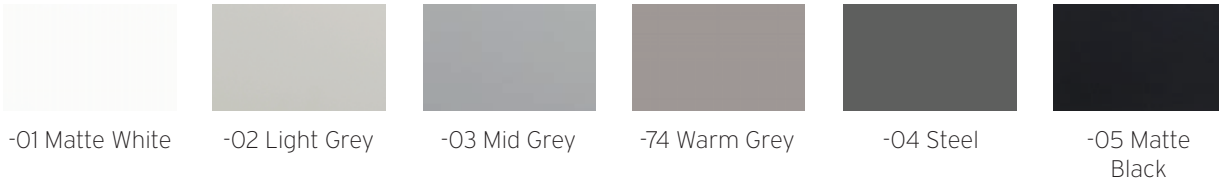

Pearl Powder Coats

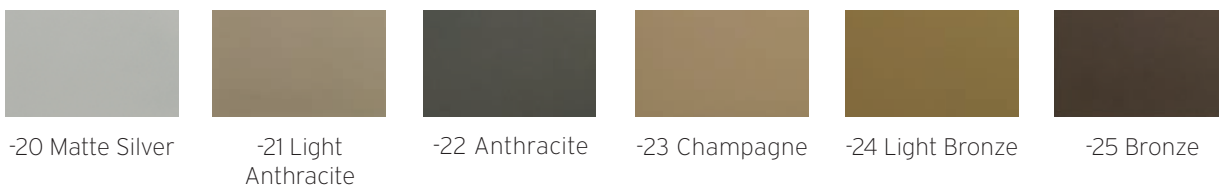

Fenix Powder Coats - *color matched to FENIX®*

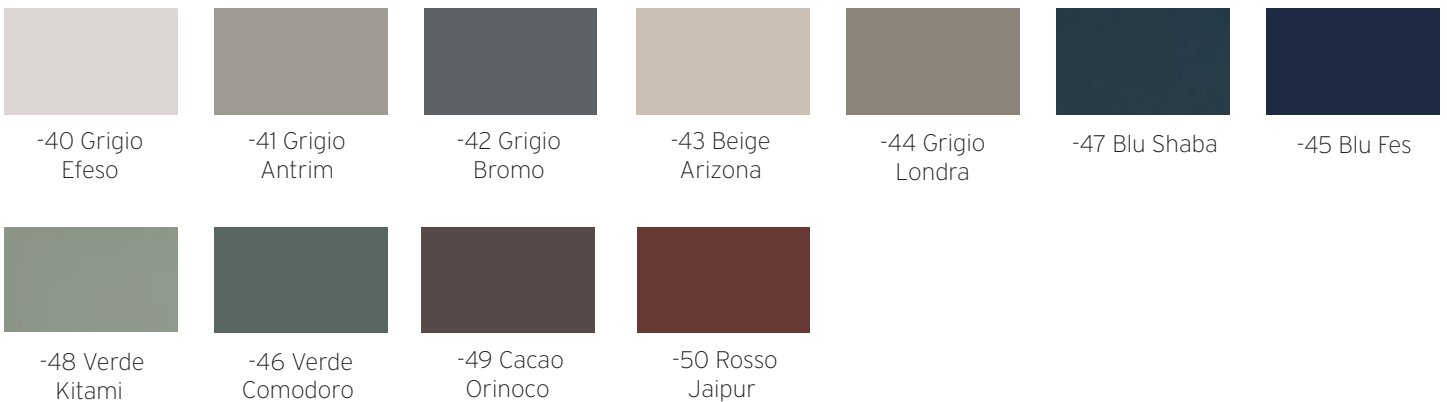

Color Trend Powder Coats

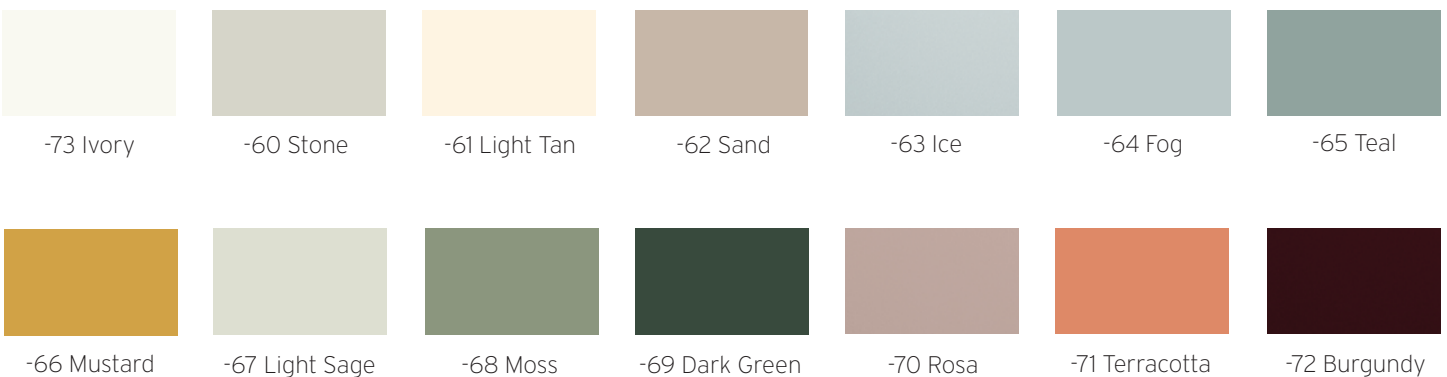

Example 1:

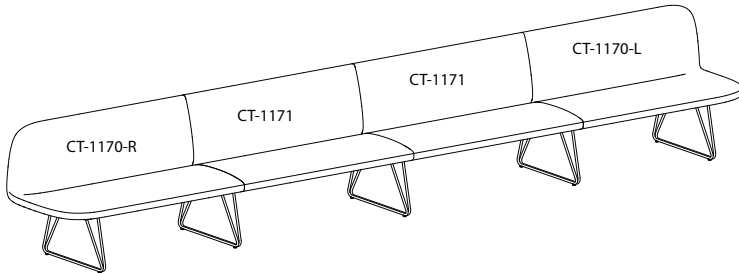

Legs

(5) **CT-Leg-B** - Leg for Backed Unit

Modular Units

CT-1170-R - End Low Back Unit - Right

(2) **CT-1171** - Straight Unit

CT-1170-L - End Low Back Unit - Left

Example 2:

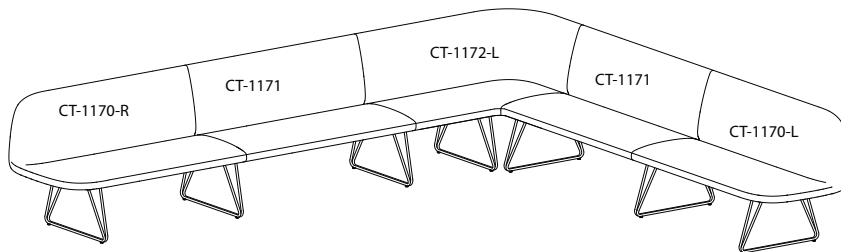

Legs

(7) **CT-Leg-B** - Leg for Backed Unit

Modular Units

CT-1170-R - End Low Back Unit - Right

(2) **CT-1171** - Straight Unit

CT-1172-L - Corner Low Back - Left

CT-1170-L - End Low Back Unit - Left

Example 3:

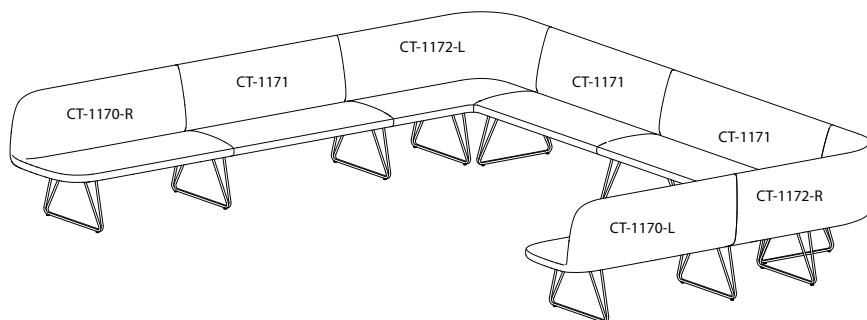

Legs

(10) **CT-Leg-B** - Leg for Backed Unit

Modular Units

CT-1170-R - End Low Back Unit - Right

CT-1171 - Straight Unit

CT-1172-L - Corner Low Back - Left

(2) **CT-1171** - Straight Unit

CT-1172-R - Corner Low Back - Right

CT-1170-L - End Low Back Unit - Left

FREESTANDING UNITS

CANTINA Series

Example: item number CT-50 = CT-50

Item	Description	Dimensions	w	inches			Yardage / Square Feet	Shipping Weight
				d	h			
CT-50	Backless Bench	Outside	50 †	25	17 1/2	2 yds. / 36 sq. ft.		

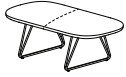

List Price
Grades

COM/COL	A	B	C	D	E	F	G	H	I	J	K	L
3058	3116	3174	3232	3290	3348	3406	3464	3522	3580	3638	3696	3754

Item	Description	Dimensions	w	inches			Yardage / Square Feet	Shipping Weight
				d	h			
CT-66	Backless Bench	Outside	66 †	25	17 1/2	2 3/4 yds. / 49 1/2 sq. ft.		

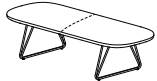

List Price
Grades

COM/COL	A	B	C	D	E	F	G	H	I	J	K	L
3366	3432	3498	3564	3630	3696	3762	3828	3894	3960	4026	4092	4158

Item	Description	Dimensions	w	inches			Yardage / Square Feet	Shipping Weight
				d	h			
CT-74	Backless Bench	Outside	74 †	25	17 1/2	3 1/4 yds. / 58 1/2 sq. ft.		

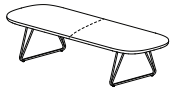

List Price
Grades

COM/COL	A	B	C	D	E	F	G	H	I	J	K	L
3578	3665	3752	3839	3926	4013	4100	4187	4274	4361	4448	4535	4622

Item	Description	Dimensions	w	inches			Yardage / Square Feet	Shipping Weight
				d	h			
CT-90	Backless Bench	Outside	90 †	25	17 1/2	3 1/2 yds. / 63 sq. ft.		

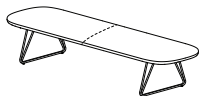

List Price
Grades

COM/COL	A	B	C	D	E	F	G	H	I	J	K	L
4021	4116	4211	4306	4401	4496	4591	4686	4781	4876	4971	5066	5161

Required to Specify

Fabrics or Leather : Ensure graded in material or COM/COL is approved for use on Cantina by contacting Davis.

Metal Finish : See [page 6](#) for all powder coat options

FREESTANDING UNITS

CANTINA Series

Example: item number CT-166 = CT-166

Item	Description	Dimensions	w	inches		Yardage / Square Feet	Shipping Weight
				d	h		
CT-166	Two Seater Low Back	Outside	66 ±	25	32 1/2	4 3/4 yds. / 85 1/2 sq. ft.	
		Inside		20	15		
		Seat			17 1/2		

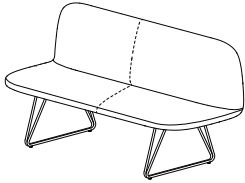

List Price
Grades
COM/COL

	A	B	C	D	E	F	G	H	I	J	K	L	
	5699	5823	5947	6071	6195	6319	6443	6567	6691	6815	6939	7063	7187

Item	Description	Dimensions	w	inches		Yardage / Square Feet	Shipping Weight
				d	h		
CT-190	Three Seater Low Back	Outside	90 ±	25	32 1/2	5 1/4 yds. / 94 1/2 sq. ft.	
		Inside		20	15		
		Seat			17 1/2		

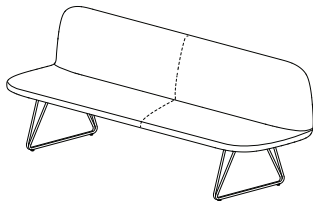

List Price
Grades
COM/COL

	A	B	C	D	E	F	G	H	I	J	K	L	
	6291	6436	6581	6726	6871	7016	7161	7306	7451	7596	7741	7886	8031

Required to Specify

Fabrics or Leather : Ensure graded in material or COM/COL is approved for use on Cantina by contacting Davis.

Metal Finish : See **page 6** for all powder coat options

Example: item number **CT-266** = **CT-266**

Item	Description	Dimensions	w	inches			Yardage / Square Feet	Shipping Weight
				d	h			
CT-266	Two Seater High Back Bench	Outside	66 †	25	46 1/4	6 1/2 yds. / 117 sq. ft.		
		Inside		20				28 3/4
		Seat						17 1/2

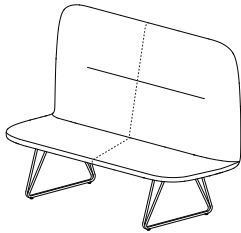

List Price
Grades

COM/COL	A	B	C	D	E	F	G	H	I	J	K	L
6013	6187	6361	6535	6709	6883	7057	7231	7405	7579	7753	7927	8101

Item	Description	Dimensions	w	inches			Yardage / Square Feet	Shipping Weight
				d	h			
CT-290	Three Seater High Back Bench	Outside	90 †	25	46 1/4	6 3/4 yds. / 121 1/2 sq. ft.		
		Inside		20				28 3/4
		Seat						17 1/2

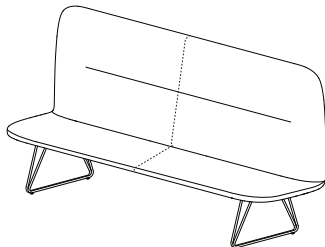

List Price
Grades

COM/COL	A	B	C	D	E	F	G	H	I	J	K	L
6924	7106	7288	7470	7652	7834	8016	8198	8380	8562	8744	8926	9108

Required to Specify

Fabrics or Leather : Ensure graded in material or COM/COL is approved for use on Cantina by contacting Davis.

Metal Finish : See **page 6** for all powder coat options

58" WIDE L SHAPED UNITS

CANTINA Series

Example: item number CT-189-58-L-LB = CT-189-58-L-LB

Item	Description	Dimensions	w	inches			Yardage / Square Feet	Shipping Weight
				d	h			
CT-189-58-L-LB	L Shaped	Outside	58 ±	89 ±	32 1/2	8 1/4 yds. / 148 1/2 sq. ft.		
CT-189-58-R-LB	Low Back	Inside	53	84				
		Seat			17 1/2			

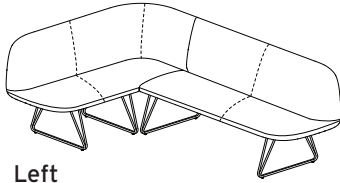

Left

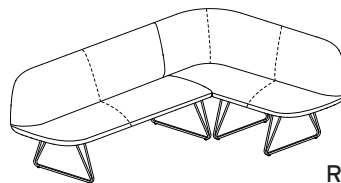

Right

List Price
Grades

COM/COL	A	B	C	D	E	F	G	H	I	J	K	L
11293	11511	11729	11947	12165	12383	12601	12819	13037	13255	13473	13691	13909

Required to Specify

Fabrics or Leather : Ensure graded in material or COM/COL is approved for use on Cantina by contacting Davis.

Metal Finish : See [page 6](#) for all powder coat options

Configuration includes the Riza Table

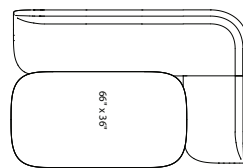
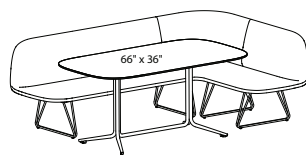

CT-189-58-R-LB

with 66" x 36" Riza Table

Item	Description	w	d	h	-AA (vener)	-OA (vener)	-WW (vener)	-LAM (lamine)	-FX (fenix)
36" Wide Rounded Rec. Top RZ-3666	36" x 66" Top	66	36	29	3979	3979	4156	3616	4058

Required to Specify

Top Finish See [page 4 - 5](#) for all top options

Metal Finish : See [page 6](#) for all powder coat options

58" WIDE L SHAPED UNITS

CANTINA Series

Example: item number CT-113-58-L-LB = CT-113-58-L-LB

Item	Description	Dimensions	inches			Yardage / Square Feet	Shipping Weight
			w	d	h		
CT-113-58-L-LB	L Shaped	Outside	58 ±	113 ±	32 1/2	8 1/2 yds. / 153 sq. ft.	
CT-113-58-R-LB	Low Back	Inside	53	108			
		Seat			17 1/2		

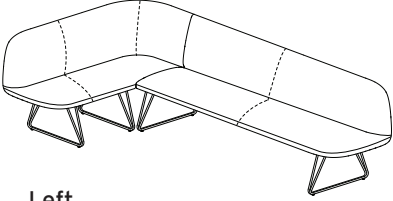

Left

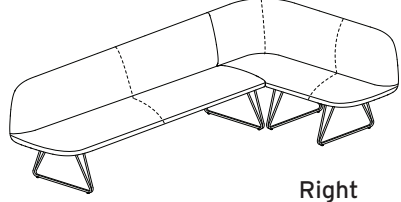

Right

List Price	Grades											
COM/COL	A	B	C	D	E	F	G	H	I	J	K	L
12088	12313	12538	12763	12988	13213	13438	13663	13888	14113	14338	14563	14788

Required to Specify

Fabrics or Leather : Ensure graded in material or COM/COL is approved for use on Cantina by contacting Davis.

Metal Finish : See [page 6](#) for all powder coat options

Configuration includes the Riza Table

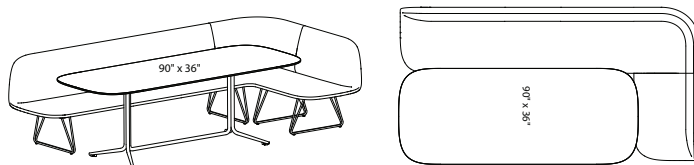

CT-113-58-R-LB

with 90" x 36" Riza Table

Item	Description	w	d	h	-AA	-OA	-WW	-LAM	-FX
					(vener)	(vener)	(vener)	(lamine)	(fenix)
36" Wide Rounded Rec. Top	RZ-3690 36" x 90" Top	90	36	29	4453	4453	4688	3925	4526

Required to Specify

Top Finish See [page 4 - 5](#) for all top options

Metal Finish : See [page 6](#) for all powder coat options

Example: item number CT-189-64-L-LB = CT-189-64-L-LB

Item	Description	Dimensions	inches			Yardage / Square Feet	Shipping Weight
			w	d	h		
CT-189-64-L-LB	L Shaped	Outside	64 †	89 †	32 1/2	9 yds. / 162 sq. ft.	
CT-189-64-R-LB	Low Back	Inside	59	84			
		Seat			17 1/2		

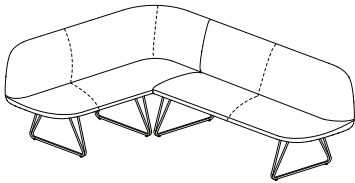

Left

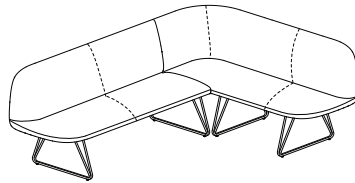

Right

List Price
Grades

COM/COL	A	B	C	D	E	F	G	H	I	J	K	L
11592	11824	12056	12288	12520	12752	12984	13216	13448	13680	13912	14144	14376

Required to Specify

Fabrics or Leather : Ensure graded in material or COM/COL is approved for use on Cantina by contacting Davis.

Metal Finish : See [page 6](#) for all powder coat options

Configuration includes the Riza Table

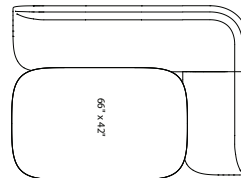
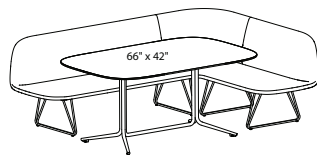

CT-189-64-R-LB

with 66" x 42" Riza Table

Item	Description	w	d	h	-AA	-OA	-WW	-LAM	-FX
					(veneer)	(veneer)	(veneer)	(laminate)	(fenix)
42" Wide Rounded Rec. Top RZ-4266	42" x 66" Top	66	42	29	5004	5004	5207	4558	5074

Required to Specify

Top Finish See [page 4 - 5](#) for all top options

Metal Finish : See [page 6](#) for all powder coat options

Example: item number CT-113-64-L-LB = CT-113-64-L-LB

Item	Description	Dimensions	inches			Yardage / Square Feet	Shipping Weight
			w	d	h		
CT-113-64-L-LB	L Shaped	Outside	64 ±	113 ±	32 1/2	9 1/4 yds. / 166 1/2 sq. ft.	
CT-113-64-R-LB	Low Back	Inside	59	108			
		Seat			17 1/2		

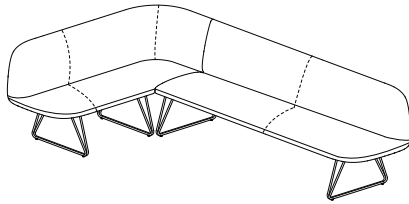

Left

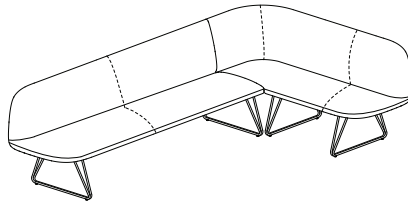

Right

List Price
Grades

COM/COL	A	B	C	D	E	F	G	H	I	J	K	L
12387	12634	12881	13128	13375	13622	13869	14116	14363	14610	14857	15104	15351

Required to Specify

Fabrics or Leather : Ensure graded in material or COM/COL is approved for use on Cantina by contacting Davis.

Metal Finish : See [page 6](#) for all powder coat options

Configuration includes the Riza Table

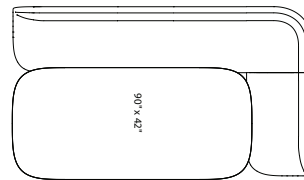
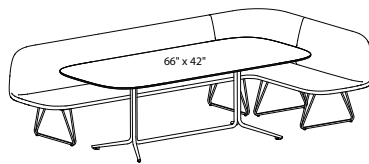

CT-113-64-R-LB

with 90" x 42" Riza Table

Item	Description	w	d	h	-AA	-OA	-WW	-LAM	-FX
					(veneer)	(veneer)	(veneer)	(laminate)	(fenix)
42" Wide Rounded Rec. Top	RZ-4290 42" x 90" Top	90	42	29	5566	5566	5838	4928	5625

Required to Specify

Top Finish See [page 4 - 5](#) for all top options

Metal Finish : See [page 6](#) for all powder coat options

58" WIDE L SHAPED UNITS

CANTINA Series

Example: item number CT-189-58-L-HB = CT-189-58-L-HB

Item	Description	Dimensions	w	inches		Yardage / Square Feet	Shipping Weight
				d	h		
CT-189-58-L-HB	L Shaped High Back	Outside	58 ±	89 ±	46 1/4	11 1/2 yds. / 207 sq. ft.	
CT-189-58-R-HB		Inside	53	84			
		Seat			17 1/2		

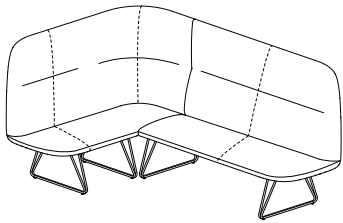

Left

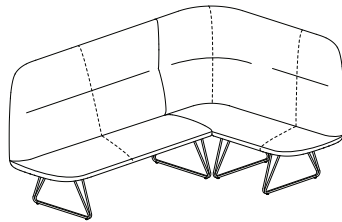

Right

List Price
Grades
COM/COL

COM/COL	A	B	C	D	E	F	G	H	I	J	K	L
11745	12050	12355	12660	12965	13270	13575	13880	14185	14490	14795	15100	15405

Required to Specify

Fabrics or Leather : Ensure graded in material or COM/COL is approved for use on Cantina by contacting Davis.

Metal Finish : See [page 6](#) for all powder coat options

Configuration includes the Riza Table

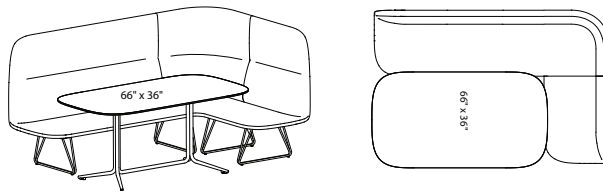

CT-189-58-R-HB

with 66" x 36" Riza Table

Item	Description	w	d	h	-AA	-OA	-WW	-LAM	-FX
					(vener)	(vener)	(vener)	(laminat)	(fenix)
36" Wide Rounded Rec. Top	RZ-3666 36" x 66" Top	66	36	29	3979	3979	4156	3616	4058

Required to Specify

Top Finish See [page 4 - 5](#) for all top options

Metal Finish : See [page 6](#) for all powder coat options

58" WIDE L SHAPED UNITS

CANTINA Series

Example: item number CT-113-58-L-HB = CT-113-58-L-HB

Item	Description	Dimensions	inches			Yardage / Square Feet	Shipping Weight
			w	d	h		
CT-113-58-L-HB	L Shaped	Outside	58 ±	113 ±	46 1/4	13 1/2 yds. / 243 sq. ft.	
CT-113-58-R-HB	High Back	Inside	53	108			
		Seat			17 1/2		

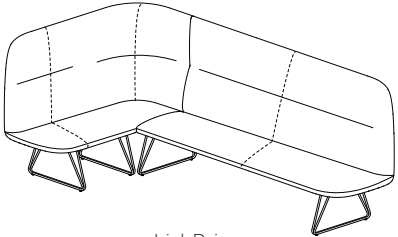

Left

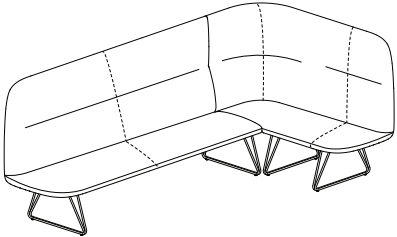

Right

List Price	Grades											
COM/COL	A	B	C	D	E	F	G	H	I	J	K	L
12634	12990	13346	13702	14058	14414	14770	15126	15482	15838	16194	16550	16906

Required to Specify

Fabrics or Leather : Ensure graded in material or COM/COL is approved for use on Cantina by contacting Davis.

Metal Finish : See [page 6](#) for all powder coat options

Configuration includes the Riza Table

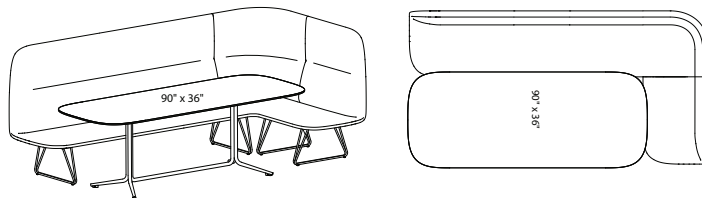

CT-113-58-R-HB

with 90" x 36" Riza Table

Item	Description	w	d	h	-AA (veneer)	-OA (veneer)	-WW (veneer)	-LAM (laminate)	-FX (fenix)
36" Wide Rounded Rec. Top	RZ-3690 36" x 90" Top	90	36	29	4453	4453	4688	3925	4526

Required to Specify

Top Finish See [page 4 - 5](#) for all top options

Metal Finish : See [page 6](#) for all powder coat options

Example: item number CT-189-64-L-HB = CT-189-64-L-HB

Item	Description	Dimensions	inches			Yardage / Square Feet	Shipping Weight
			w	d	h		
CT-189-64-L-HB	L Shaped	Outside	64 ±	89 ±	46 1/4	12 1/2 yds. / 225 sq. ft.	
CT-189-64-R-HB	High Back	Inside	59	84			
		Seat			17 1/2		

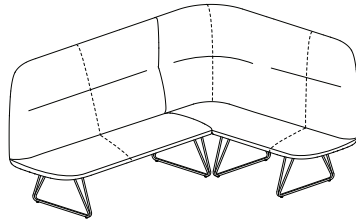
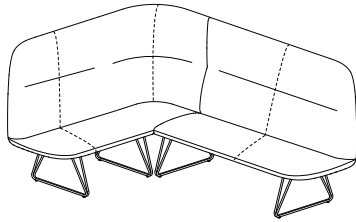

Left

Right

List Price
Grades

COM/COL	A	B	C	D	E	F	G	H	I	J	K	L
12071	12405	12739	13073	13407	13741	14075	14409	14743	15077	15411	15745	16079

Required to Specify

Fabrics or Leather : Ensure graded in material or COM/COL is approved for use on Cantina by contacting Davis.

Metal Finish : See [page 6](#) for all powder coat options

Configuration includes the Riza Table

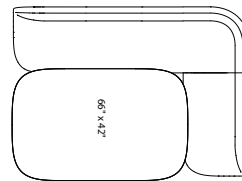
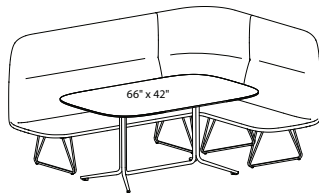

CT-189-64-R-LB

with 66" x 42" Riza Table

Item	Description	w	d	h	-AA (vener)	-OA (vener)	-WW (vener)	-LAM (lamine)	-FX (fenix)
42" Wide Rounded Rec. Top RZ-4266	42" x 66" Top	66	42	29	5004	5004	5207	4558	5074

Required to Specify

Top Finish See [page 4 - 5](#) for all top options

Metal Finish : See [page 6](#) for all powder coat options

Example: item number CT-113-64-L-HB = CT-113-64-L-HB

Item	Description	Dimensions	inches			Yardage / Square Feet	Shipping Weight
			w	d	h		
CT-113-64-L-HB	L Shaped High Back	Outside	64 ±	113 ±	46 1/4	11 3/4 yds. / 211 1/2 sq. ft.	
CT-113-64-R-HB		Inside	59	108			
		Seat			17 1/2		

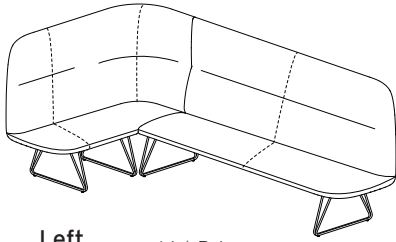

Left

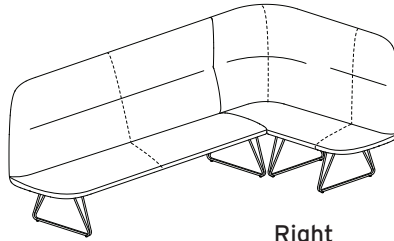

Right

List Price
Grades

COM/COL	A	B	C	D	E	F	G	H	I	J	K	L
12961	13273	13585	13897	14209	14521	14833	15145	15457	15769	16081	16393	16705

Required to Specify

Fabrics or Leather : Ensure graded in material or COM/COL is approved for use on Cantina by contacting Davis.

Metal Finish : See **page 6** for all powder coat options

Configuration includes the Riza Table

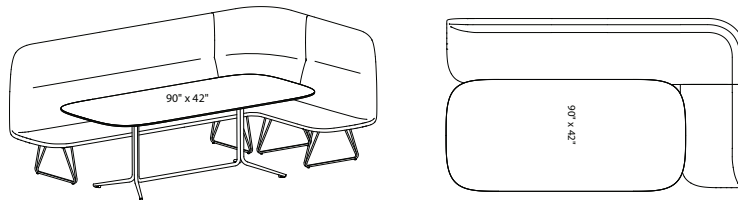

CT-113-64-R-LB

with 90" x 42" Riza Table

Item	Description	w	d	h	-AA (veneer)	-OA (veneer)	-WW (veneer)	-LAM (laminate)	-FX (fenix)
42" Wide Rounded Rec. Top RZ-4290	42" x 90" Top	90	42	29	5566	5566	5838	4928	5625

Required to Specify

Top Finish See **page 4 - 5** for all top options

Metal Finish : See **page 6** for all powder coat options

U SHAPED BOOTH

CANTINA Series

Example: item number CT-4000 = CT-4000

Item	Description	Dimensions	inches			Yardage / Square Feet	Shipping Weight
			w	d	h		
CT-4000	U SHAPED BOOTH Low Back Bench	Outside Seat	82 ±	89 ±	32 1/2 17 1/2	14 3/4 yds. / 265 1/2 sq. ft.	

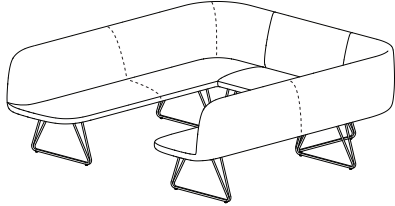

NOTE: The Davis Riza table **RZ-3660** works best with this configuration. Please see the Riza price list for table information.

List Price
Grades

COM/COL	A	B	C	D	E	F	G	H	I	J	K	L
17419	17811	18203	18595	18987	19379	19771	20163	20555	20947	21339	21731	22123

Item	Description	Dimensions	inches			Yardage / Square Feet	Shipping Weight
			w	d	h		
CT-4001	U SHAPED BOOTH High Back Bench	Outside Seat	82 ±	89 ±	46 1/4 17 1/2	18 1/4 yds. / 328 1/2 sq. ft.	

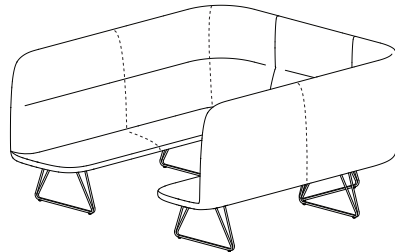

NOTE: The Davis Riza table **RZ-3660** works best with this configuration. Please see the Riza price list for table information.

List Price
Grades

COM/COL	A	B	C	D	E	F	G	H	I	J	K	L
18940	19426	19912	20398	20884	21370	21856	22342	22828	23314	23800	24286	24772

Required to Specify

Fabrics or Leather : Ensure graded in material or COM/COL is approved for use on Cantina by contacting Davis.

Metal Finish : See **page 6** for all powder coat options

Example: item number CT-Leg-BL = CT-Leg-BL

Item	Description	Dimensions	w	inches d	h	Shipping Weight
CT-Leg-BL	Leg for Backless Unit	Outside	4	22 ⁷ / ₈	13 ¹ / ₄	lbs.



List Price

294

Item	Description	Dimensions	w	inches d	h	Shipping Weight
CT-Leg-B	Leg for Backed Unit	Outside	4	22 ⁷ / ₈	13 ¹ / ₄	lbs.

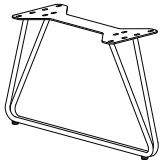

List Price

294

Required to Specify

Metal Finish : See **page 6** for all powder coat options

Example: item number CT-70 = CT-70

Item	Description	Dimensions	w	inches		Yardage / Square Feet	Shipping Weight
				d	h		
CT-70	End Backless Bench	Outside	52 ±	25	4 1/4	2 1/4 yds. / 40 1/2 sq. ft.	



List Price
Grades

COM/COL	A	B	C	D	E	F	G	H	I	J	K	L
3113	3171	3229	3287	3345	3403	3461	3519	3577	3635	3693	3751	3809

Item	Description	Dimensions	w	inches		Yardage / Square Feet	Shipping Weight
				d	h		
CT-71	Straight Backless Bench	Outside	50 ±	25	4 1/4	2 1/2 yds. / 45 sq. ft.	

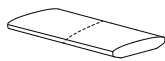

List Price
Grades

COM/COL	A	B	C	D	E	F	G	H	I	J	K	L
2980	3046	3112	3178	3244	3310	3376	3442	3508	3574	3640	3706	3772

Required to Specify

Fabrics or Leather : Ensure graded in material or COM/COL is approved for use on Cantina by contacting Davis.

Example: item number CT-1170-L = CT-1170-L

Item	Description	Dimensions	w	inches			Yardage / Square Feet	Shipping Weight
				d	h			
CT-1170-L CT-1170-R	End Low Back	Outside	52 †	25	19 1/4	3 yds. / 54 sq. ft.		

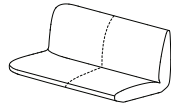
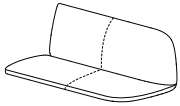

Left	List Price Grades COM/COL	Right											
		A	B	C	D	E	F	G	H	I	J	K	L
	4416	4496	4576	4656	4736	4816	4896	4976	5056	5136	5216	5296	5376

Item	Description	Dimensions	w	inches			Yardage / Square Feet	Shipping Weight
				d	h			
CT-1171	Straight Low Back	Outside	50 1/2 †	25	19 1/4	3 1/4 yds. / 58 1/2 sq. ft.		

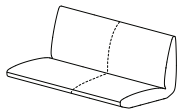

List Price Grades COM/COL	Right											
	A	B	C	D	E	F	G	H	I	J	K	L
3908	3995	4082	4169	4256	4343	4430	4517	4604	4691	4778	4865	4952

Item	Description	Dimensions	w	inches			Yardage / Square Feet	Shipping Weight
				d	h			
CT-1172-L CT-1172-R	Corner Low Back	Outside	50 †	25	19 1/4	3 1/4 yds. / 58 1/2 sq. ft.		

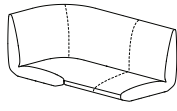
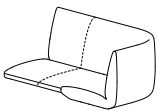

Left	List Price Grades COM/COL	Right											
		A	B	C	D	E	F	G	H	I	J	K	L
	4332	4419	4506	4593	4680	4767	4854	4941	5028	5115	5202	5289	5376

Required to Specify

Fabrics or Leather : Ensure graded in material or COM/COL is approved for use on Cantina by contacting Davis.

Example: item number CT-2170-L = CT-2170-L

Item	Description	Dimensions	w	inches			Yardage / Square Feet	Shipping Weight
				d	h			
CT-2170-L CT-2170-R	End High Back Bench	Outside	52 †	25	33	4 yds. / 72 sq. ft.		

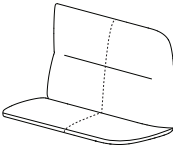

Left

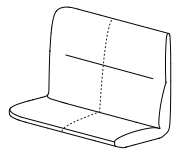

Right

List Price Grades

COM/COL	A	B	C	D	E	F	G	H	I	J	K	L
4677	4786	4895	5004	5113	5222	5331	5440	5549	5658	5767	5876	5985

Item	Description	Dimensions	w	inches			Yardage / Square Feet	Shipping Weight
				d	h			
CT-2171	Straight High Back Bench	Outside	50 1/2 †	25	33	4 1/2 yds / 81 sq. ft.		

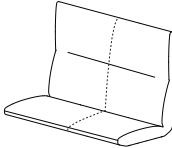

List Price Grades

COM/COL	A	B	C	D	E	F	G	H	I	J	K	L
4146	4262	4378	4494	4610	4726	4842	4958	5074	5190	5306	5422	5538

Item	Description	Dimensions	w	inches			Yardage / Square Feet	Shipping Weight
				d	h			
CT-2172-L CT-2172-R	Corner High Back Bench	Outside	50 †	25	33	4 1/2 yds. / 81 sq. ft.		

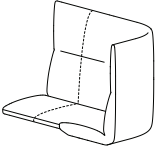

Left

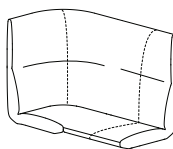

Right

List Price Grades

COM/COL	A	B	C	D	E	F	G	H	I	J	K	L
4684	4808	4932	5056	5180	5304	5428	5552	5676	5800	5924	6048	6172

Required to Specify

Fabrics or Leather : Ensure graded in material or COM/COL is approved for use on Cantina by contacting Davis.