

DAVIS®

Tavo Table Price List

Designed by jehs+laub
Effective January 1, 2026



TAVO Table Series

Specifications	2
Images.....	3
Veneer/Soild Wood.....	4
FENIX®.....	5
Powder Coat	6

SMALL MEETING TABLES

TV-148	7
TV-154	7
TV-160	7
TV-248	7
TV-254	7
TV-260	7
Small Meeting Electrical.....	8-9

SINGLE BASE TABLES

TV-3678	10
TV-3984	10
TV-4296	10
TV-4202	10

DOUBLE BASE TABLES

TV-4820	11
TV-5420	11
TV-5444	11
TV-5468	11
TV-5492	11
TV-6092	11

ELECTRICAL.....	12-14
-----------------	-------

For information concerning Condition of Sales, Warranty, Fabric, Finishes, etc., please download the *Conditions of Sales.pdf* on the Davis web site: www.davisfurniture.com

FEATURES

Base

Light and Dark grey molded concrete

Glides

Adjustable glides are standard

Tops

Solid Wood - Solid Light Ash and Heartwood Ash, Oak, and Walnut tops. Clear lacquer is standard for solid wood tops

Veneer or FENIX® - MDF core with veneer or FENIX® top. All FENIX® tops are edge banded with a matching ABS edge band

Edge Detail

Veneer Top

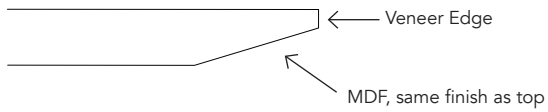

FENIX® Top

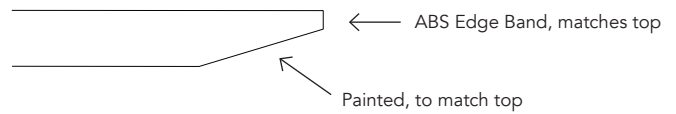

Solid Wood Top



BASE OPTIONS



Single Base - Small Meeting Table



Single Base - Conference Table



Double Base - Conference Table

CONCRETE BASE COLOR OPTIONS



TV-Light Grey



TV-Dark Grey



Connector

-must specify powder coat color

Ash Veneer



30 Vanilla Ash

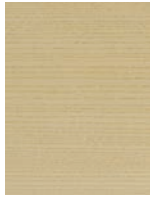

31 Natural Ash



32 Sand Ash

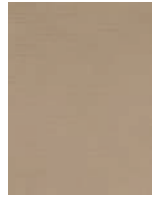

33 Toasted Ash

Oak Veneer

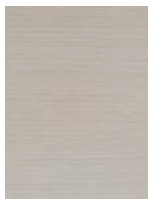

10 Alabaster
White Oak

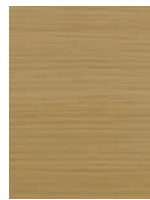

11 Light Oak

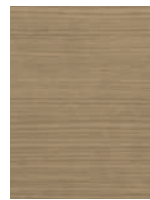

12 Golden
Oak

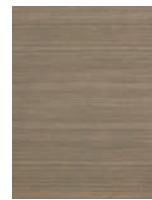

13 Harvest
Oak

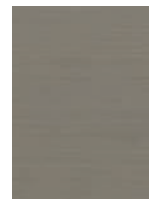

14 Slate Oak

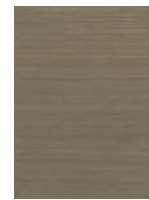

15 Mineral Grey
Oak



16 Dark Oak

Walnut Veneer

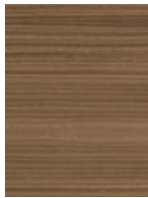

20 Clear
Walnut

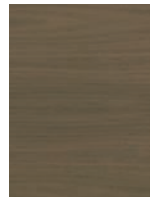

21 Light Grey
Walnut

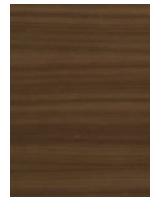

22 Classic
Walnut

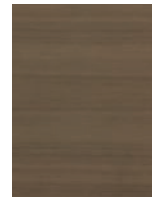

23 Mocha
Walnut

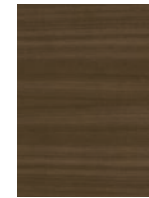

24 Midnight
Walnut

Solid Wood - Solid Wood standard finish is clear lacquer.



ASH Solid Wood
-Heartwood Ash



ASH Solid Wood
-Light Ash



OAK Solid Wood



WALNUT Solid Wood

FENIX® Innovative Materials

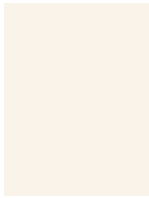

Bianco Kos

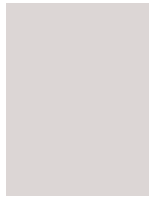

Grigio Efeso



Grigio Antrim



Grigio Bromo



Beige Arizona



Grigio Londra



Cacao Orinoco



Rosso Jaipur

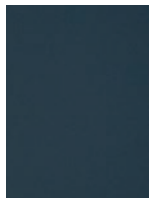

Blu Shaba



Blu Fes



Verde Kitami



Verde Comodoro



Nero Ingo

All Fenix have ABS Edgebands to match top.

Powder Coats

Neutral Powder Coats

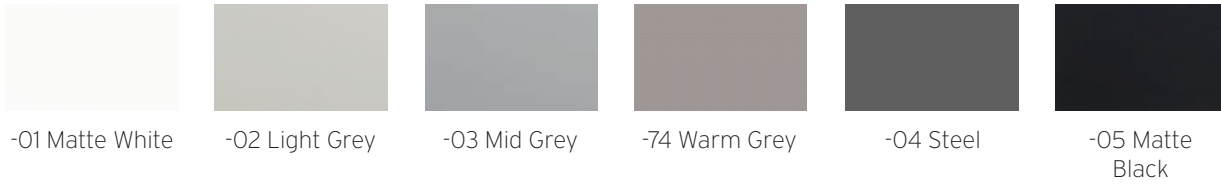

Pearl Powder Coats

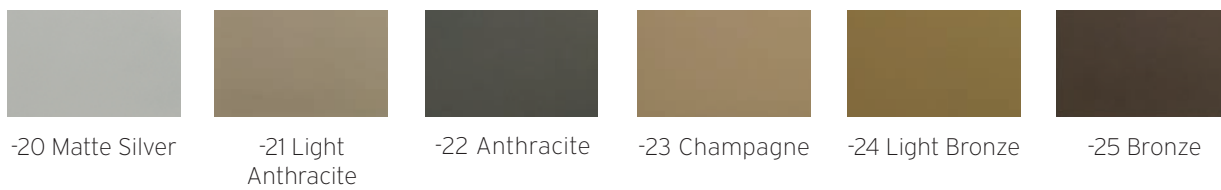

Fenix Powder Coats - *color matched to FENIX®*

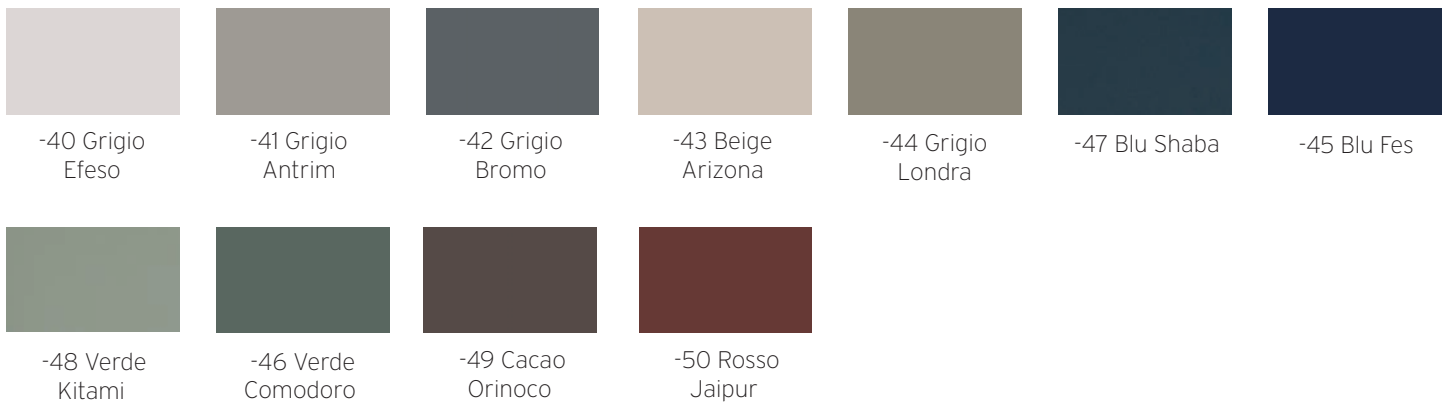

Color Trend Powder Coats

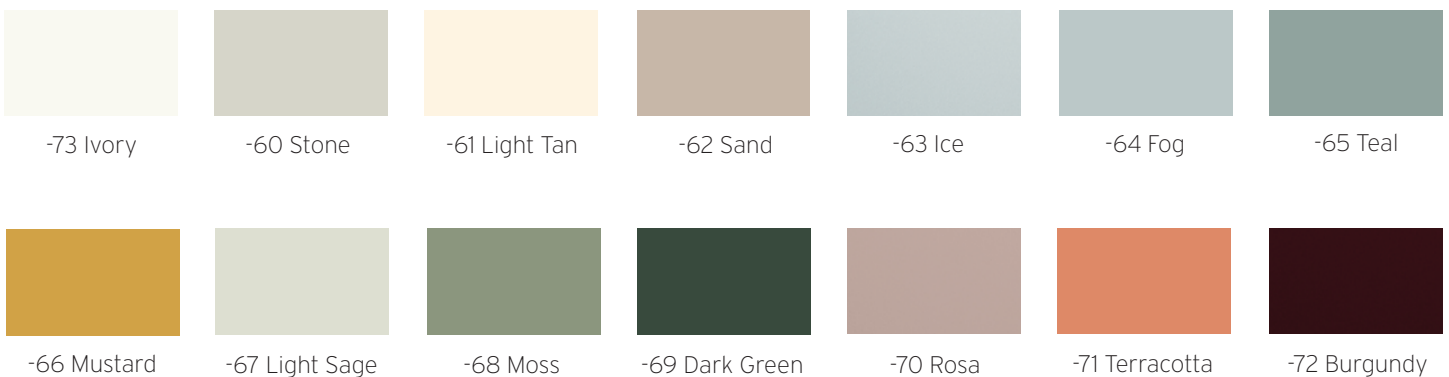

SINGLE BASE - SMALL MEETING TABLES

TAVO Table Series

Example: item number **TV-148** + top material suffix **-OA** = **TV-148-OA**

List Price

Surface Material

Item	Description	dia	h	-AA (veneer)	-OA (veneer)	-WW (veneer)	-HASW (solid wood)	-LASW (solid wood)	-OASW (solid wood)	-WWSW (solid wood)	-FX (fenix)
Round Tops TV-148	48" Round Top	48	29 1/4	9321	9321	9411	17469	17469	17862	19810	9440
TV-154	54" Round Top	54	29 1/4	9707	9707	9822	18722	18722	19218	21684	9925
TV-160	60" Round Top	60	29 1/4	10187	10187	10317	20157	20157	20773	25371	10438

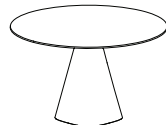
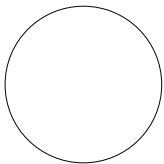

TV-148

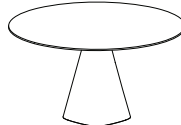

TV-154

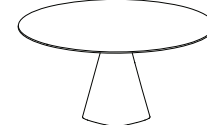

TV-160

Item	Description	d	w	h	-AA (veneer)	-OA (veneer)	-WW (veneer)	-HASW (solid wood)	-LASW (solid wood)	-OASW (solid wood)	-WWSW (solid wood)	-FX (fenix)
Soft Square Tops TV-248	48" Soft Square Top	48	48	29 1/4	9321	9321	9411	17469	17469	17862	19810	9440
TV-254	54" Soft Square Top	54	54	29 1/4	9707	9707	9822	18722	18722	19218	21684	9925
TV-260	60" Soft Square Top	60	60	29 1/4	10187	10187	10443	20157	20157	20773	25371	10438

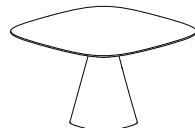
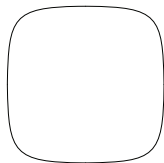

TV-248

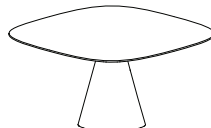

TV-254

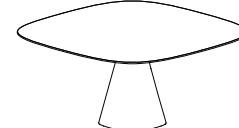

TV-260

Base Dimensions:

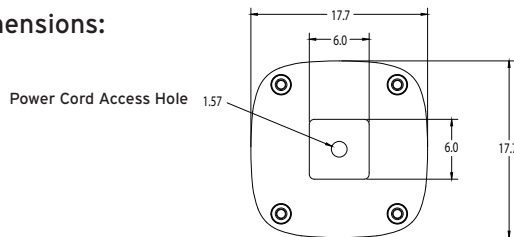

Base Underside View

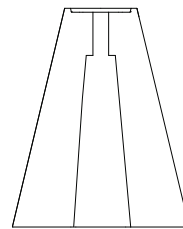

Base Profile View

**See page 8 for power option*

Required to Specify

Concrete Base : TV-Light Grey or TV-Dark Grey

Connector Finishes : See **page 6** for all standard powder coats

Top Finishes : See **page 4 & 5** for top finish options.

When ordering power please follow the guidelines below.

1. Select Power Box with one or two power strips for table - **PB-C2 - \$2,210**
2. Specify Electrical Data Components (choose *two* components for each power strip - one **must** be power)
 - **Power, USB-AC** - power strip *one*
 - **Power, Power** - power strip *two*

EXAMPLE: PB-C-2-PU-PP - \$2,210 + 0 + 248 + 0 + 0 = \$2,458

Item	Description
PB-C	Power Box with <i>One</i> or <i>Two</i> Power Strips - <i>must specify number of power strips</i>

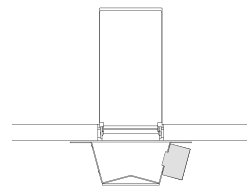
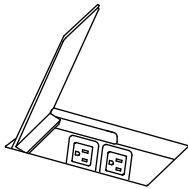

End View
One Strip

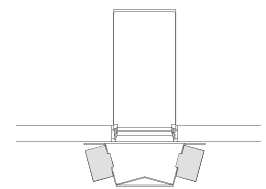

End View
Two Strips

	List Price
PB-C1 Power Box with One Power Strip	1926
PB-C2 Power Box with Two Power Strips	2210

Electrical Data Components - *Must specify two:*

Component Options	List Price
P - Power	No Upcharge
U - USB-AC	248
H - HDMI	495
R - RJ45 Cat.6	217
O - Open receptacle	No Upcharge

NOTE: 3' End power cord with plug included

***Customer needs to supply female to female cables when HDMI and RJ45 components are selected. Contact factory with questions.**

Davis will select the location of components in strip unless customer requests a custom order. Contact Customer Service if custom order is required.

Please see below for placement of electrical boxes.

- see *hinge placement example to the right*

Hinge
Side

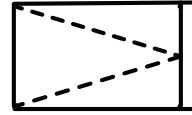

Power Box placement for PB-C

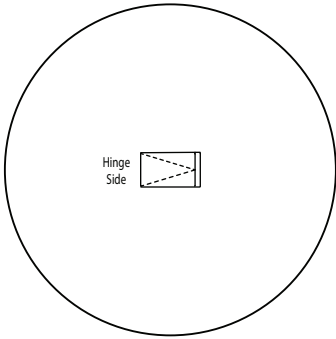

Top Sizes

- TV-148 - 48" Round
- TV-154 - 54" Round
- TV-160 - 60" Round

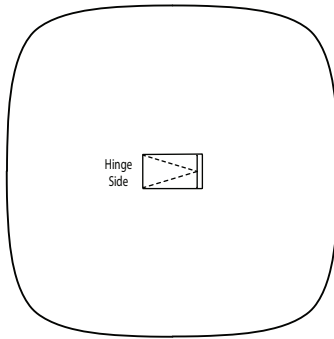

Top Sizes

- TV-248 - 48" x 48" Soft Square
- TV-254 - 54" x 54" Soft Square
- TV-260 - 60" x 60" Soft Square

Example: item number **TV-3678** + top material suffix **-OA** = **TV-3678-OA**

List Price

Surface Material

Item	Description	d	w	h	-AA (veneer)	-OA (veneer)	-WW (veneer)	-HASW (solid wood)	-LASW (solid wood)	-OASW (solid wood)	-WWSW (solid wood)	-FX (fenix)
TV-3678	78" Ellipse Top	78	36	29 1/4	7970	7970	8011	17709	17709	17709	20427	8092
TV-3984	84" Ellipse Top	84	39	29 1/4	8570	8570	8658	19308	19308	19308	22465	8745
TV-4296	96" Ellipse Top	96	42	29 1/4	8981	8981	9073	21980	21980	21980	25867	9165
TV-4202	102" Ellipse Top	102	42	29 1/4	9090	9090	9182	22594	22594	22594	26571	9275

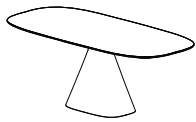

TV-3678

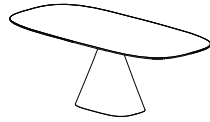

TV-3984

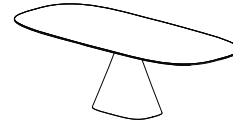

TV-4296

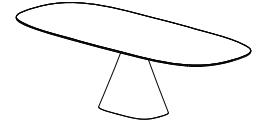

TV-4202

Base Dimensions:

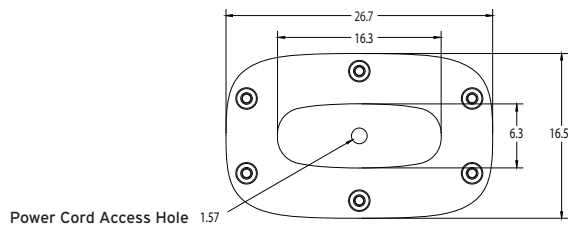

Base Underside View

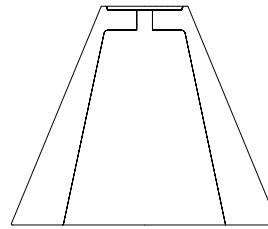

Base Profile View

**See page 12 - 13 for power options*

Required to Specify

Concrete Base : TV-Light Grey or TV-Dark Grey

Connector Finishes : See **page 6** for all standard powder coats

Top Finishes : See **page 4 & 5** for top finish options.

DOUBLE BASE CONFERENCE TABLES

TAVO Table Series

Example: item number **TV-4820** + top material suffix **-OA** = **TV-4820-OA**

List Price

Surface Material

Item	Description	d	w	h	-AA (veneer)	-OA (veneer)	-WW (veneer)	-HASW (solid wood)	-LASW (solid wood)	-OASW (solid wood)	-WWSW (solid wood)	-FX (fenix)
TV-4820	120" Ellipse Top	120	48	29 1/4	21384	21384	21603	35865	35865	35865	40488	21821
TV-5420	120" Ellipse Top	120	54	29 1/4	21758	21758	21981	37980	37980	37980	43175	22203
TV-5444	144" Ellipse Top	144	54	29 1/4	23848	23848	24091	42062	42062	42062	48604	24334
TV-5468	168" Ellipse Top	168	54	29 1/4	24958	24958	25212	45517	45517	45517	53151	25467
TV-5492	192" Ellipse Top	192	54	29 1/4	26365	26365	26634	49280	49280	49280	58006	26903
TV-6092	192" Ellipse Top	192	60	29 1/4	27114	27114	27390	52151	52151	52151	62016	27667

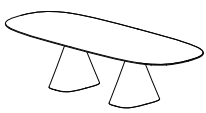

TV-4820

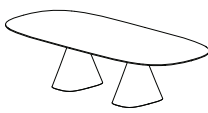

TV-5420

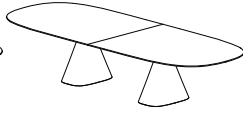

TV-5444

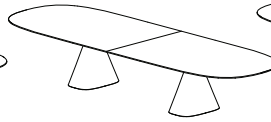

TV-5468

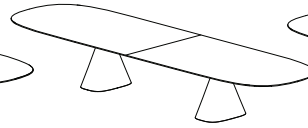

TV-5492

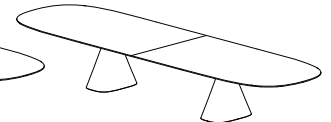

TV-6092

* Note that if a double top is preferred for TV-4820 or TV-5420, please contact customer service.

Base Dimensions:

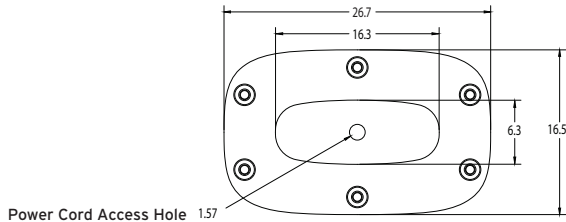

Base Underside View

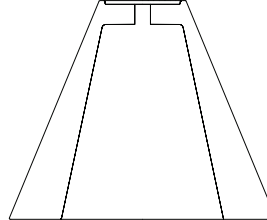

Base Profile View

*See page 12 - 13 for power options

Required to Specify

Concrete Base : TV-Light Grey or TV-Dark Grey

Connector Finishes : See page 6 for all standard powder coats

Top Finishes : See page 4 & 5 for top finish options.

When ordering power please follow the guidelines below.

1. Select Power Box with **one** power strip for table - **PB-A - \$2,097**
2. Specify Electrical Data Components (choose *three* components - *one must be power*) - **Power, USB-AC, HDMI**

EXAMPLE: PB-A-PUH - \$2,097 + 0 + 248 + 495 = \$2,840

Item	Description
------	-------------

PB-A	Power Box with One Power Strip
------	--------------------------------

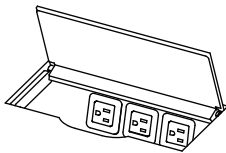

Used with solid wood tops

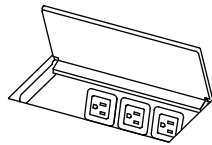

Used with veneer of Fenix laminate tops

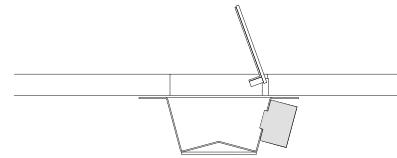

End View

List Price

PB-A Power Box	2097 (must order two if a double base table is ordered, except for TV-4820 or TV-5420)
----------------	---

Note: TV-4820 and TV-5420 can have one or two power boxes.

Electrical Data Components - Must specify three:

Component Options	List Price
P - Power	No Upcharge
U - USB-AC	248
H - HDMI	495
R - RJ45 Cat.6	217
O - Open receptacle	No Upcharge

NOTE: 6' End power cord with plug included

Davis will select the location of components in strip unless customer requests a custom order. Contact Customer Service if custom order is required.

When ordering power please follow the guidelines below.

1. Select Power Box with **two** power strips for table - **PB-B - \$2,451**
2. Specify Electrical Data Components (choose **three** components for each power strip - one **must** be power)
 - Power, USB-AC, HDMI - power strip **one**
 - Power, Power, RJ45 - power strip **two**

EXAMPLE: PB-B-PUH-PPR - \$2,451 + 0 + 248 + 495 + 0 + 0 + 217 = \$3,411

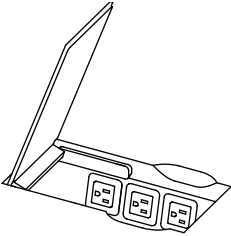
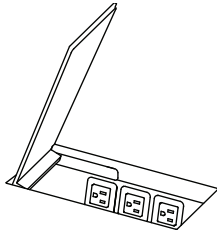
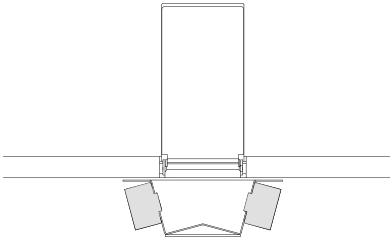
Item	Description
PB-B	Power Box with Two Power Strips
	<div style="display: flex; justify-content: space-around; align-items: flex-end;"> <div style="text-align: center;">  <p>Used with solid wood tops</p> </div> <div style="text-align: center;">  <p>Used with veneer of Fenix laminate tops</p> </div> <div style="text-align: center;">  <p>End View</p> </div> </div>
	List Price
PB-B Power Box	2451 (must order two if a double base table is ordered, except for TV-4820 or TV-5420)

Note: TV-4820 and TV-5420 can have one or two power boxes.

Electrical Data Components - Must specify three:

Component Options	List Price
P - Power	No Upcharge
U - USB-AC	248
H - HDMI	495
R - RJ45 Cat.6	217
O - Open receptacle	No Upcharge

NOTE: 6' End power cord with plug included

Davis will select the location of components in strip unless customer requests a custom order. Contact Customer Service if custom order is required.

Please see below for placement of electrical boxes.

- see hinge placement example to the right

Hinge Side

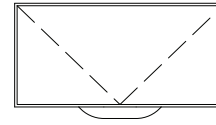

Power Box placement for PB-A

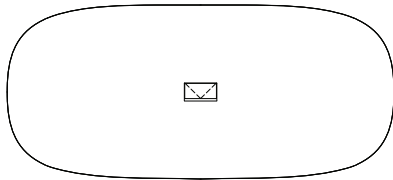

Top Sizes

TV-3678 - 78" x 36"
 TV-3984 - 84" x 39"
 TV-4296 - 96" x 42"
 TV-4202 - 102" x 42"
 TV-4820 - 120" x 48"
 TV-5420 - 120" x 54"

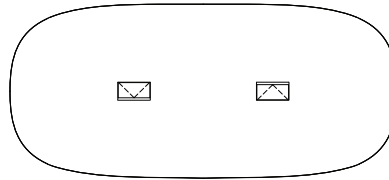

Top Sizes

TV-4820 - 120" x 48"
 TV-5420 - 120" x 54"

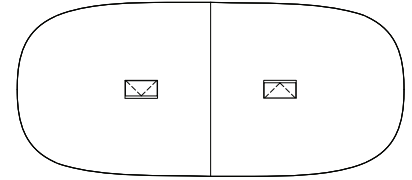

Top Sizes

TV-4820 - 120" x 48"
 TV-5420 - 120" x 54"
 TV-5444 - 144" x 54"
 TV-5468 - 168" x 54"
 TV-5492 - 192" x 54"
 TV-6092 - 192" x 60"

Note: TV-4820 and TV-5420 can have one or two power boxes.

Power Box placement for PB-B

- see hinge placement example to the right

Hinge Side

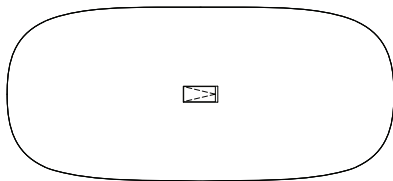
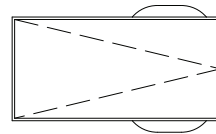

Top Sizes

TV-3678 - 78" x 36"
 TV-3984 - 84" x 39"
 TV-4296 - 96" x 42"
 TV-4202 - 102" x 42"
 TV-4820 - 120" x 48"
 TV-5420 - 120" x 54"

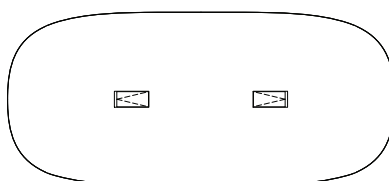

Top Sizes

TV-4820 - 120" x 48"
 TV-5420 - 120" x 54"

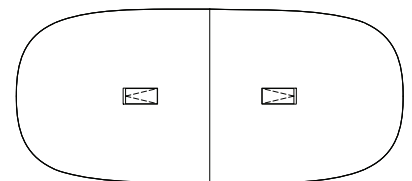

Top Sizes

TV-4820 - 120" x 48"
 TV-5420 - 120" x 54"
 TV-5444 - 144" x 54"
 TV-5468 - 168" x 54"
 TV-5492 - 192" x 54"
 TV-6092 - 192" x 60"

Note: TV-4820 and TV-5420 can have one or two power boxes.