



MODEL:

SERIAL#:

4407 Martinsburg Pike
Clear Brook, VA 22624
USA

Phone: 540-662-3811
Fax: 540-665-8101
email: sales@reimersinc.com
web: www.reimersinc.com

RV 195-210 Series Steam Boiler Models



Instructions Manual

TABLE OF CONTENTS

Limited Warranty Information.....	4
Important Safety Information.....	5
Installation.....	7
Location.....	7
Water Supply.....	8
Steam Outlet.....	8
Condensate.....	8
Safety Relief Valve.....	8
Electrical.....	8
Operation.....	9
Boiler Startup.....	9
Blowdown Valve.....	9
Control Functions.....	10
Boiler Monitor.....	10
Boiler Maintenance.....	11
Boiler Blowoff.....	11
Safety Valve Test.....	11
Element Replacement and Element Cleaning.....	11
Water Level Probe and Probe Baffle Box Cleaning....	11
Gauge Glass Replacement.....	12
Troubleshooting.....	13
Parts Lists.....	14
Parts List (Continued).....	16
Parts List (Continued).....	17

RV 195-210 STEAM BOILERS



Features

- Vertical boiler design; very low floor space requirements
- Miniature boiler max. vessel volume 5ft3
- Maximum safety valve setting 100psi
- All boilers are manufactured in accordance with the requirements of the A.S.M.E. Boiler and Pressure Vessel Code and A.S.M.E. CSD-1. Each boiler bears the National Board Stamp "M".
- Operating pressure range 0 – 85psig
- Heavy duty carbon steel pressure vessel. Vessel jacket and electrical enclosure powder coated
- Large selection of optional equipment

Standard Equipment of Each Boiler Includes:

- A.S.M.E. pressure relief valve
- High pressure cutoff control with manual reset
- One (1) operating pressure control for all models equipped with two heating elements or two (2) staged operating pressure controls for all models equipped with three or four heating elements
- Low water level cutoff control with manual reset
- High water level cutoff control with automatic or manual reset.
- Magnetic contactors
- Internal branch circuit fusing
- Enable/Disable switch for each heating element
- Main supply power distribution block
- Indicator lights for POWER, REFILLING, HEATING and ALARMS

Applications

- Process Steam
- Autoclaves/Sterilizers
- Air Humidification
- Dry Cleaning
- Food Service^(*)
- Laboratories

(*) DIRECT STEAM APPLICATIONS TO FOOD PRODUCTS: Reimers offers stainless steel boilers or #OPT1030 Brass/Bronze free boiler trim option (see Page 5). This alone does not guarantee the production of culinary grade steam. Applicable safety standards (i.e. 3-A T609) must be considered.

HEATING POWER KW	STEAM CAPACITY lbs/hr (kg/hr) ⁽⁴⁾	BHP	VOLTAGE ⁽¹⁾	PHASE	SHIP WEIGHT ⁽²⁾ lbs (kg)	PRESSURE VESSEL CAPACITY GAL. (L)	OPERATING PRESSURE RANGE psi (bar)	STEAM OUTLET (NPT)	
								LP <15psig	HP >15psig
60 KW	205 (93)	6.0	208/240/380/415/480/600	3	790 (358)	37.40 (141.58)	0 - 85 (0 - 5.86)	1-1/4	1
75 KW	256 (116)	7.5	208/240/380/415/480/600	3	790 (358)	37.40 (141.58)	0 - 85 (0 - 5.86)	1-1/4	1
90 KW	307 (139)	9.0	208/240/380/415/480/600	3	820 (372)	37.40 (141.58)	0 - 85 (0 - 5.86)	2	1-1/4
105 KW	358 (162)	10.5	208/240/380/415/480/600	3	850 (385)	37.40 (141.58)	0 - 85 (0 - 5.86)	2	1-1/4
120 KW	409 (186)	12.0	208/240/380/415/480/600	3	850 (385)	37.40 (141.58)	0 - 85 (0 - 5.86)	2	1-1/4
135 KW	461 (209)	13.5	208/240/380/415/480/600	3	950 (431)	37.40 (141.58)	0 - 85 (0 - 5.86)	2	1-1/2
150 KW	512 (232)	15.0	208/240/380/415/480/600	3	1000 (454)	37.40 (141.58)	0 - 85 (0 - 5.86)	2	1-1/2
165 KW	563 (255)	16.5	208/240/380/415/480/600	3	1000 (454)	37.40 (141.58)	0 - 85 (0 - 5.86)	2-1/2	2
180 KW	614 (279)	18.0	208/240/380/415/480/600	3	1050 (476)	37.40 (141.58)	1 - 85 (0 - 5.86)	2-1/2	2
195 KW	665 (302)	19.5	208/240/380/415/480/600	3	1100 (499)	37.40 (141.58)	2 - 85 (0 - 5.86)	2-1/2	2
210 KW	717 (325)	21.0	208/240/380/415/480/600	3	1100 (499)	37.40 (141.58)	3 - 85 (0 - 5.86)	2-1/2	2

Model Number Key

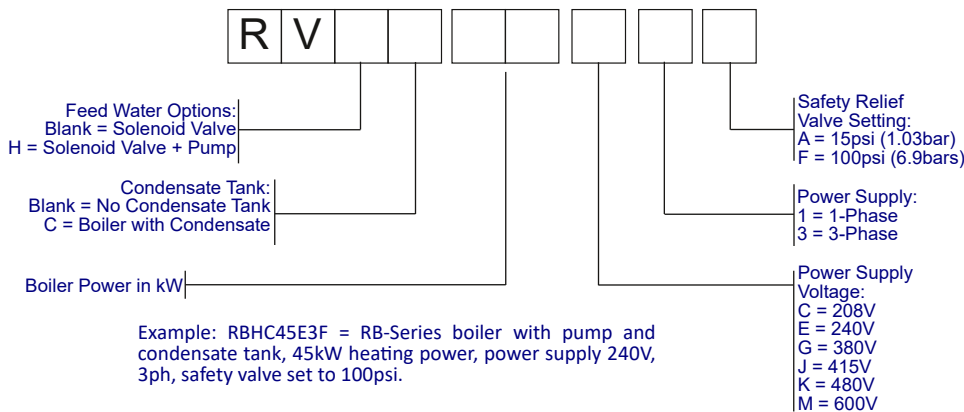

⁽¹⁾ Each boiler model requires two (2) power supplies: Primary heating power and secondary control voltage. Nominal control voltage is 120V, 50/60Hz. Boiler models rated for 380V and 415V are equipped with control voltage transformers that require 220/240V applied to their primary side in order to provide the 120V AC control voltage to the boiler. As an option, all boiler models can be equipped with control voltage transformers so that only the heating power supply needs to be connected to the boiler.

⁽²⁾ Also available in 240V 1PH

⁽³⁾ On boiler equipped with condensate tank, add 90lbs (41.0kg) to shipping weight

⁽⁴⁾ The STEAM CAPACITY listed above is based on the evaporation rate from and at 212°F, at 0 psig. If the boiler feed water temperature is 50°F, then the STEAM CAPACITY for each model listed above is approximately 15% lower.

Please note that all information provided within this brochure is approximate and subject to change without notice. Please contact Reimers Electra Steam, Inc. with any questions regarding the specifications or dimensions detailed within.

LIMITED WARRANTY – STEAM GENERATORS

Reimers Electra Steam, Inc. warrants the following products of its own manufacture against defects in materials and workmanship under normal use and service. This warranty is in lieu and excludes all other expressed or implied warranties or merchantability of fitness for any particular use. No person is authorized to extend the terms of this warranty or assume any other liability except by written statement signed by an officer of Reimers Electra Steam, Inc. Clear Brook, Virginia 22624.

WARRANTY PERIOD

The pressure vessel and electrical & mechanical components are warranted for one year from date of shipment from Reimers Electra Steam, Inc. in Clear Brook, VA 22624.

LIMITATIONS

Products must be installed, used and maintained in accordance with our instructions, including reasonable & necessary maintenance by the user. Users are responsible for the suitability of the products to their application. There is no warranty for damage resulting from improper installation, abuse, power failure, fire, flood, lightening, improper water, misuse, improper specification, misapplication or other operating conditions beyond our control or parts that are normally expendable in usual course of operation.

Claims against carriers for damage in transit must be filed by the buyer. Reimers liability, if any, will not exceed the price of Reimers products claimed to be defective.

Components manufactured by any supplier other than Reimers shall bear only that warranty made by the manufacturer of that product and service for that warranty shall be the responsibility of that manufacturer and not Reimers.

REMEDY

Claims under this Limited Warranty must be made by obtaining a Return Authorization Number from our office (PHONE: 540-662-3811, FAX: 540-665-8101) & returning the defective part, freight prepaid to: Reimers Electra Steam, Inc., 4407 Martinsburg Pike, Clear Brook, Virginia 22624

Defective items will be repaired or replaced as necessary within a reasonable time without charge, other than incidental charges such as freight prepayment. Such repair or replacement within a reasonable time is the exclusive remedy available from Reimers Electra Steam, Inc., under this Limited Warranty.

CONSEQUENTIAL DAMAGES

Reimers Electra Steam, Inc., is not liable for labor costs incurred in the removal, reinstallation, or unauthorized repair of product, or for damages of any type whatsoever, including incidental and/or consequential damages.

THIS WARRANTY SUPERSEDES ALL PREVIOUS WARRANTIES.



**Read this manual before installing and using this product.
Failure to do so can result in serious injury or death.**

You have just purchased a quality steam boiler designed to the ASME Boiler Code and registered with the National Board of Boiler Inspectors. Treat this industrial equipment with care and respect. It is safe when installed, maintained, and used properly. Read the instruction carefully and contact the factory if you have any questions.



WARNING Read this manual before installing and using this product.
Failure to do so can result in serious injury or death.

Your boiler should be marked with a complete set of WARNING/CAUTION labels shown below. If one of these labels is missing, please contact our factory immediately.

US and All Other Non-Francophone Countries

Located on electrical enclosure door

Canada and All Other Francophone Countries

⚠ WARNING		⚠ ADVERTENCIA	
	Risk of electric shock. This boiler is connected to more than one branch circuits. Disconnect all power and control circuits before servicing.		Riesgo the electrochoque. Esta caldera está conectado a mas de un circuito de alimentación. Desconecte los todos circuitos antes de realizar el mantenimiento.
	Read and understand the operator's manual before using this boiler.		Lea y comprenda el manual de instrucciones antes de utilizar esta

Located on end caps of cylindrical boiler pressure vessel jacket

⚠ WARNING		⚠ AVERTISSEMENT	
	Risk of electric shock. Disconnect all branch circuits before removing this cover.		Risque de choc électrique. Débrancher tous les circuits avant de retirer le couvert.

Located on end caps of cylindrical boiler pressure vessel jacket

⚠ CAUTION		⚠ ATENCIÓN	
	All exposed pipes and valves may be hot. Do not touch.		Las tuberías y valvulas expuestas pueden estar calientes. No toque.

⚠ CAUTION		⚠ PRUDENCE	
	All exposed pipes and valves may be hot. Do not touch.		Tous les tuyaux et valves exposées peuvent être chauds Ne pas toucher

This manual contains safety messages. Each of the safety messages are preceded by one of the following signal word panels:



DANGER Safety messages preceded by this label contain information, that if not followed will result in death or serious injury.



WARNING Safety messages preceded by this label contain information, that if not followed could result in death or serious injury.



CAUTION Safety messages preceded by this label contain information, that if not followed could result in minor or moderate injury.



NOTICE Messages preceded by this label contain important information, but are not hazard-related.

Ensure that this manual is available to the boiler operator at any time.

Read carefully all safety labels attached to the boiler. If any safety label was damaged during shipment, contact the factory immediately:

Ph. 540-662-3811; e-mail: sales@reimersinc.com

Important Safety Information



1. BLOWDOWN VALVE: This valve is utilized to blow impurities from the boiler chamber. When opened, a large volume of hot water and steam is discharged. Ensure that this valve is properly piped for such discharge. State and local codes must be met as applicable.

2. ELECTRICAL: All field wiring to the boiler must be in accordance with the National Electric Code and any local codes that may apply. Wiring must be made by a competent certified electrician. Use copper wire only. Ensure that all electrical components are in a dry location, free from any possibility of water soaking. Electric foot switches when supplied must not be placed on a wet floor. They must be placed on dry surface, not subject to steam or water.

3. GAUGE GLASS: The gauge glass protector guards must be on at all times. When replacing the glass, be sure that the unit is not under pressure and is cool to touch. The gauge glass should be replaced once per year. If cracks or wear is evident, replace the gauge glass immediately.

4. MODIFICATION/MISUSE: This boiler has been designed and constructed in accordance with the ASME Boiler and Pressure Vessel Code. Any modification or misuse can result in a dangerous situation. Reimers Electra Steam, Inc. is not liable for any product that has been modified or improperly used.

5. PRESSURE GAUGE: The pressure gauge indicates the internal pressure of the boiler. It can fail. Periodically have your boiler inspector compare the gauge with a known gauge utilizing the test valve arrangement provided

6. REGISTRATION: Most states and cities require boiler registration and inspection. Check with your government authorities.

7. INSTALLATION AND REPAIR:

Installation and repair work of this unit must be performed only by experienced personnel. Before commencing a repair, ensure that the boiler is cold, not pressurized and electrically disconnected. All standard electrical and steam safety precautions must be taken during testing.

8. SAFETY VALVE: The safety valve is designed to discharge hot steam when the set pressure is exceeded. Ensure that the discharge port is pointing toward the back of the unit away from the operator or any aisles. Test the safety valve periodically to ensure that it is operating properly. Test carefully at full pressure by lifting lever using pliers and let it "slapping" shut. Steam discharge can scald. Ensure no one is exposed.

9. STEAM INSTALLATION:

Steam piping must be of black pipe, not galvanized. Work must be done by an experienced steam fitter. All state and local codes must be met as applicable.

10. WATER: Ensure that all electrical components are in a dry location, free from any possibility of water soaking. Electric foot switches when supplied must not be placed on a wet floor. They must be placed on dry surface not subject to steam or water.

1. Installation

REIMERS ELECTRA STEAM, INC. boilers are heated by one or more immersion type heating elements. Automatic controls are provided to maintain pre-set operating pressure and proper water supply. Safety features include automatic low water cutoff, automatic pressure control, safety valve and visible water level gauge. Each boiler is manufactured in accordance with the ASME Power Boiler Code Standards and is individually inspected and stamped by an authorized National Board Insurance Inspector. All boilers are registered with the National Board of Boiler and Pressure Vessel Inspectors. When boiler is received, make sure it has not been damaged in shipment.

NOTE:

ASME DATA PLATE IS LOCATED ON END OF PRESSURE VESSEL BEHIND LABEL STAMPED WITH NATIONAL BOARD NUMBER OF UNIT.

When boiler is received, make sure it has not been damaged in shipment.

1.1 Location

Place the boiler in a level position, close to the equipment which it is to supply. This will insure minimum heat losses and allow more economical piping arrangements. All steam lines should be insulated. Review the overall dimensions of your boiler model on page 6 to select proper boiler location.

Regardless of the NFPA-70 working space requirements shown below, provide a minimum of 3ft clearance on both sides of the boiler for element servicing, 3ft of clearance to the front of the boiler and 1.5ft to the rear of the boiler.

a.) Working space:

Electric boiler spacing is dictated by NFPA-70, Table 110.26 as follows:

Nominal Voltage To Ground (Volts)	Minimum Clear Distance		
	Condition 1	Condition 2	Condition 3
0 – 150	3ft (914mm)	3ft (914mm)	3ft (914mm)
151 – 600	3ft (914mm)	3.5ft (1.07m)	4ft (1.22m)

Note: Where the conditions are as follows:

Condition 1 — Exposed live parts on one side of the working space and no live or grounded parts on the other side of the working space, or exposed live parts on both sides of the working space that are effectively guarded by insulating materials.

Condition 2 — Exposed live parts on one side of the working space and grounded parts on the other side of the working space. Concrete, brick, or tile walls shall be considered as grounded.

Condition 3 — Exposed live parts on both sides of the working space.

(a) *Dead-Front Assemblies.* Working space shall not be required in the back or sides of assemblies, such as dead-front switchboards or motor control centers, where all connections and all renewable or adjustable parts, such as fuses or switches, are accessible from locations other than the back or sides. Where rear access is required to work on non-electrical parts on the back of enclosed equipment, a minimum horizontal working space of 762 mm (30 in.) shall be provided.

b.) *Alcove or closet installation per UL834:* Proper location of this boiler model with regard to combustible and noncombustible surfaces and materials is coded on the boiler name plate. The following decoding sketch and description is provided for the user information:

RHP-, RHPH- and RHPHC- Models	Dimension In.						
	A	B	D	EL	ER	F	G
	3	A18	3	3	3	NC	-

Description of dimensions and symbols

A – Clearance above top of boiler

B – Clearance from front of boiler

Prefix C to numeral indicates suitability for closet or alcove installation

Prefix A indicates suitability for alcove but not for closet installation

D – Clearance from back of boiler

EL – Clearance from left side of boiler

ER – Clearance from right side of boiler

F – Indicates type of flooring: "NC" for noncombustible floor / "C" for combustible floor. Numeral indicates minimum clearance below suspended units to combustible floor

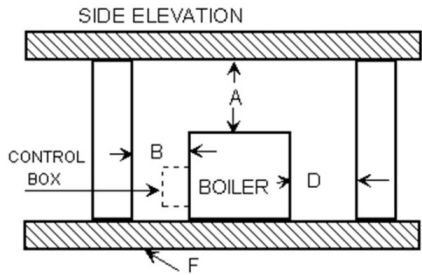
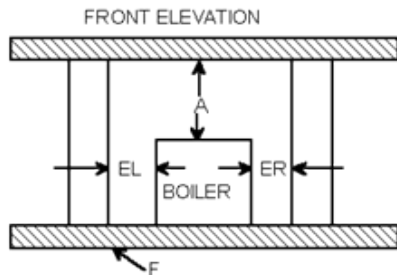

1.2 Water Supply

On models with pump and/or solenoid valve, connect incoming water supply to strainer on intake side of solenoid valve or pump.

Boiler Feed Water Supply

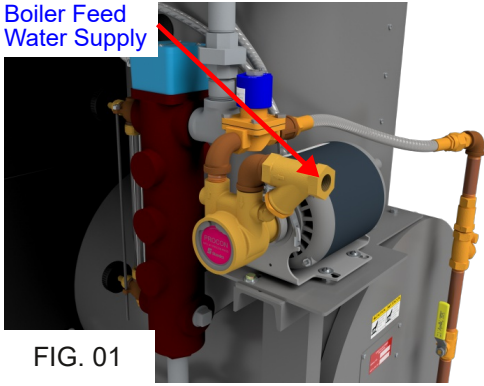

FIG. 01

On models furnished with condensate return tank, connect water line to makeup valve located at tank end. (See Instruction Supplement 1 in this manual) R, RH and RHC steam boiler models require four (4) gallons of feed water per hour for each 10 kW of electric heating capacity of the boiler. Lines should be of adequate size and meet local plumbing codes.

In order to ensure long term trouble-free boiler operation, we recommend that the water used as boiler feed water to be tested for hardness. If the water in your area is harder than 1grain (17mg/L), use a water softener. The main cause for premature heating element failure in electric steam boilers is water hardness. If severe corrosion during inspection of the pressure vessel as indicated in chapter 3.4 of this manual becomes evident, additional tests of your boiler feed water must be performed. A water analysis should be performed by a qualified and recognized water treatment company located in your area.

Recommended levels for boiler feed water:

WATER PROPERTY	MAX. LIMIT
Total hardness	17 mg/L
Dissolved Oxygen	0.04 mg/L
Total Iron	0.1 mg/L
Total Copper	0.05 mg/L
pH	> 8.5
Specific Resistivity	25kΩ * cm

Recommended levels for boiler water (water inside pressure vessel when boiler is operating)

PROPERTIES	MAX. LIMIT
Total Alkalinity	350 mg/L
Total Dissolved Solids	3500 mg/L
Total Suspended Solids	300 mg/L
pH	10.5 - 12

NOTICE

Do not add any chemicals to the boiler feed water unless specifically recommended by a qualified and recognized water treatment company.

1.3 Steam Outlet

All piping from and to the boiler must comply with the A.S.M.E. B31.1 Power Piping Code. All State and local codes must be met. All piping must be done by a qualified steam fitter.

Connect steam line of sufficient size from steam line valve to the equipment. Steam piping must be black steel pipe, not galvanized. Work must be done by an experienced steamfitter. All state and local codes must be met.

1.4 Condensate Return

If the condensate is to be returned by gravity (no tank) in a closed system, the load discharge should be at least 2 feet above the boiler level so that the weight of the condensate will actuate the check valve. When applicable, install steam return lines at sufficient height to allow a pitch of 2 inches for every 10 feet of pipe length.

Note: For condensate return systems (with tank), see special sheet.

1.5 Safety Relief Valve

The safety valve is designed to discharge hot steam when the set pressure is exceeded. Ensure that the discharge port is pointing toward the back of the unit away from the operator and any aisles. If it is required that discharge piping be installed from the safety valve, the pipe should not be smaller than the valve outlet and should be rigidly supported so as not to place weight on the valve itself.

Important: No valve in this line!

Safety Relief Valve

Steam Outlet Valve

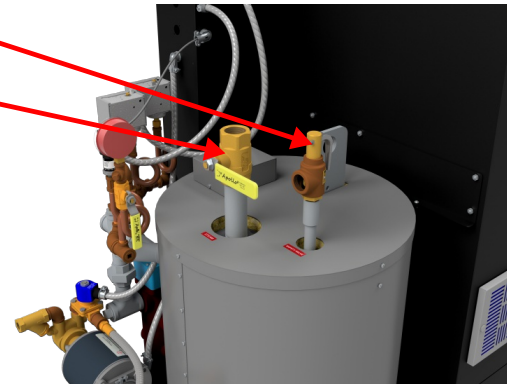

FIG. 02

1.6 Electrical

Install a fused disconnect switch near the boiler. It should be fused as marked on the boiler name plate. Connect the power supply from the disconnect switch to the terminals in the boiler control panel. A copy of the wiring diagram is in the control panel.

Important: Electrical connections to the boiler control panel (FIG. 7) should be made by a qualified Electrician. All wiring must comply with local electrical codes.

1.6.1 Three Phase Boiler Models Without Power Supply Extension Box

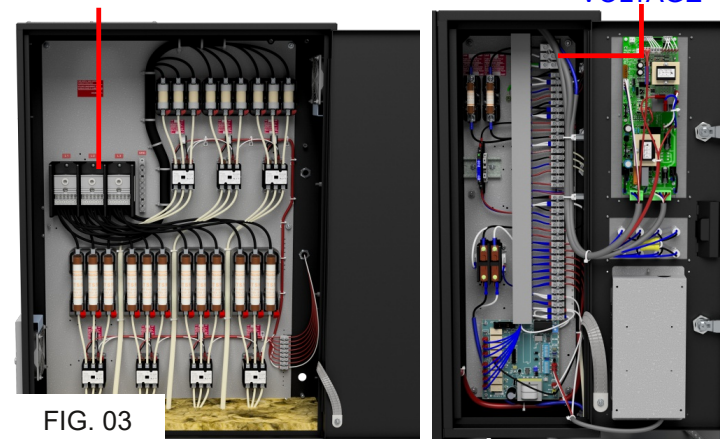

FIG. 03

All boiler models that are equipped with a transformer option (OPT1010 or OPT1011) don't require a separate external control voltage power supply.

NOTICE

Do not let the pump to run dry for an extended time as this will cause damage to the pump.

1.7 Blowdown Valve

CAUTION

When the blowdown valve is utilized, a large volume of hot water and steam is discharged. Ensure that this valve is properly piped for this discharge. State and local codes must be met as applicable.

2. Operation

2.1 Boiler Startup

a. Open steam line valve slightly. This will allow the boiler to be filled without producing back pressure.

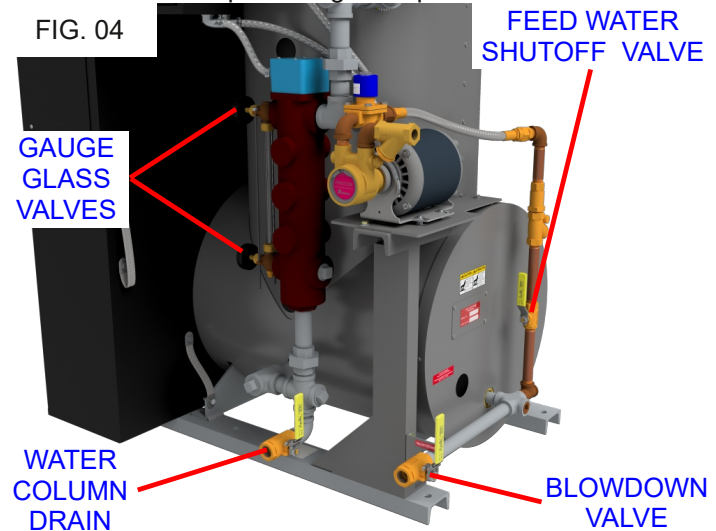

- b. Open upper and lower gauge glass fixture valve
- c. Ensure that the feed water shutoff valve is in the OPEN-position
- d. Close the boiler blow down valve & water column drain
- e. Throw the fused disconnect switch (not provided by factory) to the ON-position and turn on the boiler control voltage

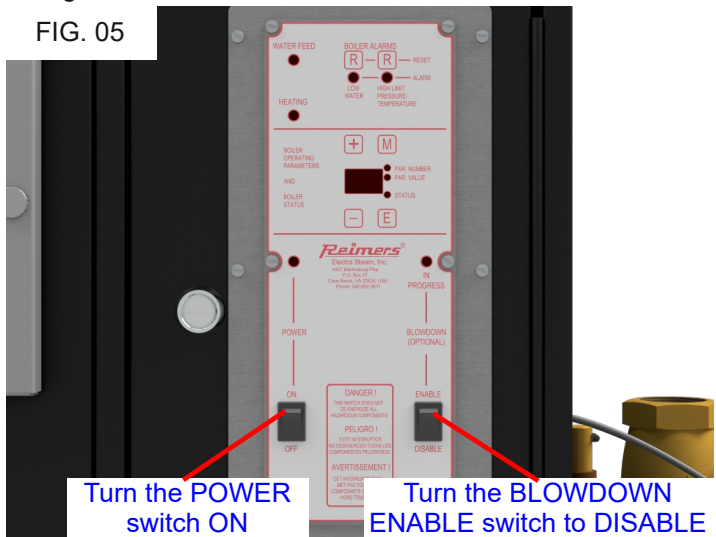

f. After approximately 2 seconds, the WATER FEED light turns on and water enters the boiler. As soon as the water level reaches approximately half height in the gauge glass, the automatic water feed turns off.

g. If the boiler controller indicates any alarms, then press the corresponding RESET button(s).

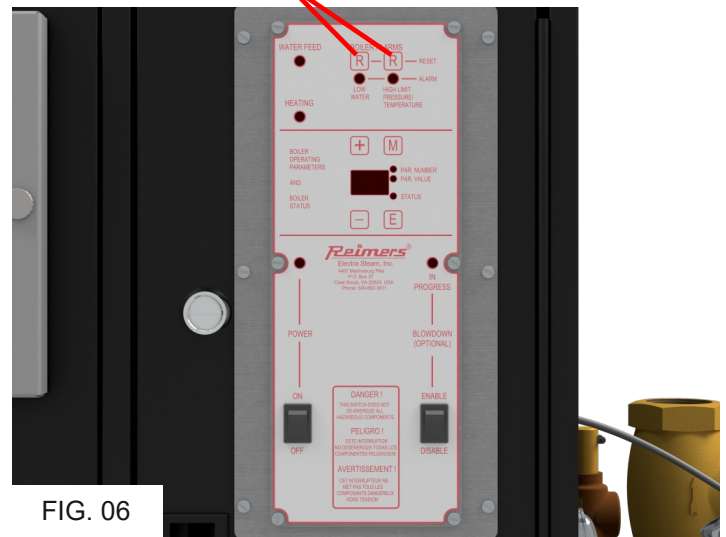

As soon as no boiler alarms are indicated, the HEATING light turns on and the boiler starts to build up pressure. Observe the pressure gauge while pressure builds up, until working pressure is reached. The working pressure should have been factory set to your specification. However, if you wish to change the working pressure setting, proceed as follows.

WARNING Stand clear of scalding water or steam. Disconnect the boiler from all power supplies.

All pressure controls are factory preset and require no adjustment. However, if a change of the operating steam pressure is required, then proceed as follows:

- Disconnect all power supplies from the boiler.
- Close the steam outlet valve
- Remove the cover from the pressure control enclosure.
- **Ranco Controls (Fig. 08):** Turn the range adjustment screw clockwise to increase the pressure and counter clockwise to decrease the pressure.
- **Tecmark Controls (Fig. 09):** Turn the black knob of the operating pressure switch clockwise to increase the pressure and counterclockwise to decrease the pressure.
- Connect all power supplies to the boiler, open the steam outlet valve, and install the pressure control enclosure covers.

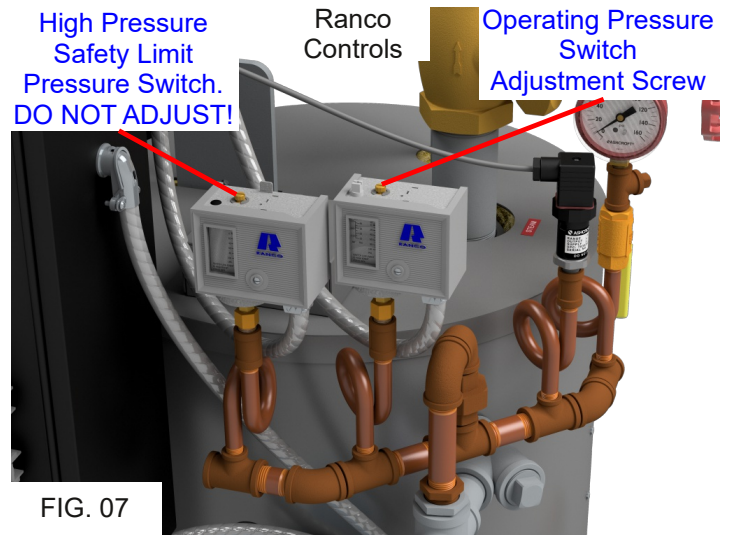

High Pressure
Safety Limit
Pressure Switch.
DO NOT ADJUST!

Tecmark
Controls

Operating Pressure
Switches
Adjustment Wheels

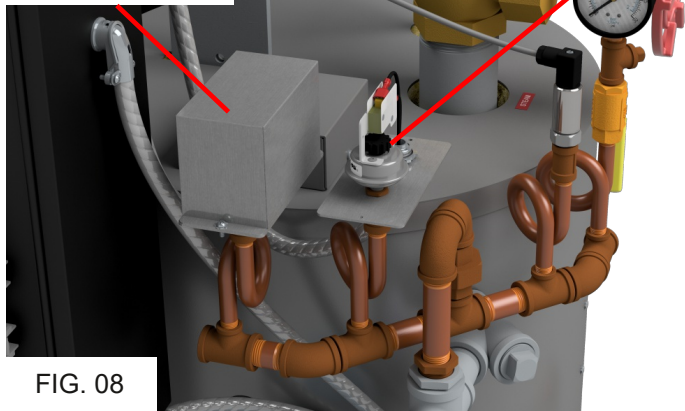

FIG. 08

h.) To shut off the boiler, turn the POWER switch on the boiler controller OFF.

2.2 Control Functions

See Boiler Control Manual for detailed instructions.

The control provides four basic functions and two optional functions. The following overview describes the functions.

Low water cutoff

Boiler high pressure cutoff

High water level feed shutoff Automatic boiler refill

Automatic boiler blowoff (Optional)

Remote controlled boiler ON/OFF and boiler status (Optional)

If installed, the Honeywell controller T775P2003 was set at the factory with its parameters as shown below and to the operating boiler pressure as ordered:

- Press & hold the MENU button for 5 seconds to display the Setup Menu
- # of Sensors = 1
- Sensor A
- TYPE = 4-20 MA
- UNITS = PSI
- MIN VALUE = 0
- MAX VALUE = 25 or 150 (Same as Transducer Rating)
- CALIBRATE = 0.0
- LABEL = BOILER A
- OUTPUTS
 - MOD 1
 - TYPE = 0-10V
 - MIN OUT = 0
 - INTEGRAL = 0
 - DERIVATIVE = 0
 - HIDE = NO
- Skip MOD 2, #RELAYS, OPTIONS RELAY 1, RELAY 2
- EXIT
- MENU (Press Once)
- PROGRAM ►
- MOD 1 ►
- SETPOINT = ? 25 or 150
- THROT. RANGE = 5 (Might Change) 2 PER STEP
- ACTION HEAT
- Skip MOD 2, RELAY 1, RELAY 2

2.2.1 Low Water Cut-Off Function

The low water cutoff function of the boiler control de-energizes the heating elements when the water level in the boiler pressure vessel falls below the minimum acceptable operating level. The control senses the water level in the boiler pressure vessel through a probe, E3. When the tip of

the probe is in contact with water in the boiler, the boiler operates normally. When the water level in the boiler falls below the tip of the probe the control senses that water level is low. The control will not de-energize the heating elements when the probe loses contact with the boiler water for short periods of time. But, when the probe loses contact with the probe for a set time, the control de-energizes the heating elements and turns on the “LOW WATER” boiler alarm light. Boiler operation can only be resumed after determining why water level is low, restoring normal water level in the boiler and pressing the “LOW WATER” reset button [R]. After pressing the “LOW WATER” reset button the alarm light “LOW WATER” turns off, the lockout is reset and the heating elements are energized.

The Low Water Cut-Off function short cycling timer can be adjusted. See the Boiler Control Manual (Doc. #9101)

2.2.2 High Pressure Cutoff Function

If the operating pressure control fails, the steam pressure in the boiler can reach the value set on the high limit pressure control. In that case, the high limit pressure control de-energizes the heating elements and locks them out. The boiler alarm light “HIGH PRESSURE” comes on. After the pressure control is replaced the HIGH PRESSURE alarm light turns off.

2.2.3 High Water Level Feed Shutoff

When the high water level cut-off probe (E2) comes in contact with boiler water, the boiler control turns off the automatic refilling device, feed pump and/or solenoid valve. At the same time the boiler controller de-energizes the heating elements, closes the steam outletline through the solenoid valve (SOL2) and displays a flashing “2” on the LED display. As soon as the probe E2 loses contact with the boiler water the boiler controller resumes normal boiler operation automatically. (The boiler controller can be set to require that the “E-Key be pressed to resume boiler operation. See the Boiler Control Manual for instructions.)

2.2.4 Automatic Boiler Refill

When the POWER switch is turned on and the water level probe (E1) is in contact with the boiler water, the boiler control keeps the boiler water feed pump and/or solenoid valve de-energized. When the water level probe (E1) loses contact with the boiler water, the boiler control energizes the boiler feed pump and/or the solenoid valve after a set ON delay time. When the water level probe makes contact with the boiler water, the boiler controller de-energizes the boiler water feed pump and/or solenoid valve after a set refill OFF delay time.

The ON and OFF delay time can be adjusted. See the boiler control manual for instructions.

If the feedwater pump and/or solenoid valve remains on for longer than the ON delay time the boiler control de-energizes the feed water pump and/or solenoid valve and displays a flashing “0” on the control LED display. The “E” ;key must be pressed to start a new re-filling attempt

2.2.5 Automatic Boiler Blowoff (Optional)

See Boiler Control Manual for instructions.

2.2.6 Remote controlled boiler ON/OFF and boiler status. (Optional)

See Boiler Control Manual for instructions.

2.3 Boiler Monitor Definitions

The following are definitions for all boiler monitor indications. See the control manual for details including adjusting all parameters.

Flashing “0”: Boiler feed pump and/or solenoid remained energized longer than the set time. Boiler feed pump and/or solenoid are de-energized. Press “E” key to re-set alarm and start a new re-filling cycle.

Flashing “1”: Following a blowdown cycle, the automatic re-fill device did not stay on for the set time. Press “E” key to re-set the alarm.

Flashing “2”: The high water level probe (E2) has come in to contact with boiler water. The feed pump and or solenoid is de-energized and the heating elements are de-energized. As soon as the probe (E2) loses contact with the boiler water normal control operation resumes. (This function may be set to require re-set using the E key.)

3. Boiler Maintenance

WARNING Boiler repairs must be performed by experienced personnel only. Ensure boiler water is cold and drained and that there is no pressure and all electricity to the boiler is shut-off.

3.1 Boiler Blowoff

All boilers must be blown off periodically to remove minerals, scale and other foreign matter, which accumulate inside the pressure vessel. The concentration of this deposit depends in part upon the condition of the water in the area. When water is naturally soft, or has been softened chemically, boiler blowoffs are required less often than in areas where hard water is found. Water softeners are suggested in hard water areas to minimize the formation of hard scale on heating elements. Another factor affecting water condition is the amount of condensate, if any, that is being returned to the boiler. Since condensate is essentially clean distilled water, it contains very few impurities. If a large part of the condensate is being returned and little make-up water is used, the boiler need not be blown down as often as when little or no condensate is returned to the boiler. We recommend blowoff of newly installed steam boilers once per day until the first heating element and pressure vessel inspection is performed (refer to chapter 3.4). If no significant amount of sediment is found on the bottom of the pressure vessel and on the heating element sheaths, then the boiler blowoff frequency can be reduced accordingly. The safest method to blowoff R-series steam boilers is to install a Reimers Electra Steam, Inc. properly sized and fully trimmed blowdown tank, model BTANK-10 (Figures 10 and 11). Reimers blowdown tanks are designed and constructed to Section VIII of the A.S.M.E. Code and inspected by a commissioned National Board Boiler inspector.

3.1.1 Boiler Blowoff Frequency

In areas where water is soft or has been softened chemically:

- When little condensate is returned blowdown once every second day
- When a large part of the condensate is returned and little make-up water is used, blowdown once every week

In areas where hard water exists:

- When little or no condensate is returned, blowdown once a day
- When a large part of the condensate is returned and little make-up water is used, blowdown once every second day

3.3 Safety Valve Test

WARNING Stand clear of scalding water or steam. Ensure that the Boiler Bottom Blowoff Valve is properly piped.

This test should be performed once per month. Proceed as follows:

- Increase the steam pressure as shown in chapter 2.1. to maximum operating pressure.
- Keep the steam outlet valve closed
- Pull the trip lever and hold open for five (5) seconds in order to flush off the valve seat.
- Permit the valve to “slap” shut. If a leak occurs, repeat this test and if necessary, replace the valve.

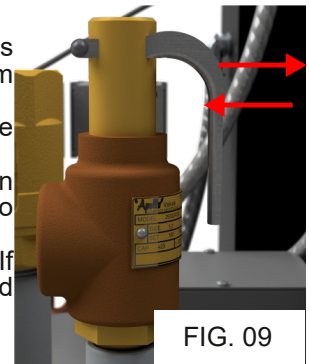

FIG. 09

3.4 Element Replacement and Element Cleaning

WARNING Ensure that the boiler is cold, drained and all power supplies are disconnected

Clean the element rods every six (6) months. To clean the element rods, or if an element must be replaced, proceed as follows:

- Open the door on the lower electrical box.
- Disconnect and label the terminal wires
- Remove all six (6) nuts from each element flange and pull out the heating element
- Use a stiff wire brush to remove all scale and foreign matter from the element rods.
- Clean the element flange surfaces before installing new elements and gaskets

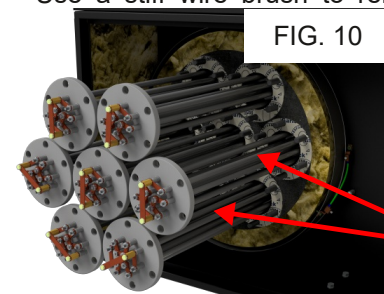

FIG. 10

Element Rods

3.5 Water Level Probe and Probe Column Cleaning

WARNING Ensure that the boiler is cold, drained and all power supplies are disconnected.

In order to provide reliable automatic water level control, the water level probes are located inside an external probe column, attached to the outside of the pressure vessel. The probe column has direct connection to the top and bottom of the pressure vessel so that the probes can read the water level, protected from foam and bursting steam bubbles that form on the surface of the boiler water.

The probe column must be cleaned every six (6) months of sediments and other debris that accumulates at the bottom of the column. To accomplish this, proceed as follows:

Step 1:

Remove the pipe plugs from the external water column piping

Step 2:

Insert a rotary cleaner, wire brush, or similar tool into the upper and lower horizontal portions of the external column piping

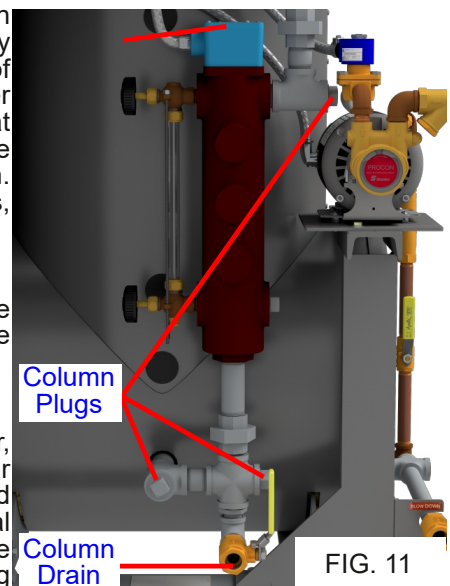

FIG. 11

and remove deposits.

Step 3:

After cleaning, reinstall the pipe plugs. Use proper pipe thread sealing material.

Step 4:

Remove the water level probe cover, disconnect the wire from the probe. Remove probe and inspect the probe rod. If sediment has accumulated, use a stiff wire brush to remove it. Install the probe in its place in the column and connect the wire back to the probe.

Repeat this procedure every 6 months. Pipe the external water column drain valve to a safe point of discharge. Open this valve for approximately 5 seconds every 3 days to remove sediments from the horizontal portion of the lower external water column piping.

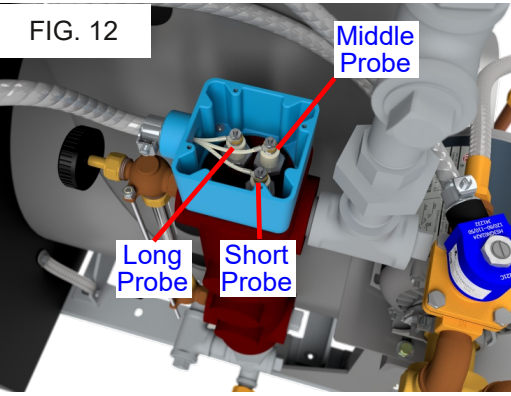

3.6 Gauge Glass Replacement

WARNING Ensure that the boiler is cold, drained and all power supplies are disconnected.

Step 1

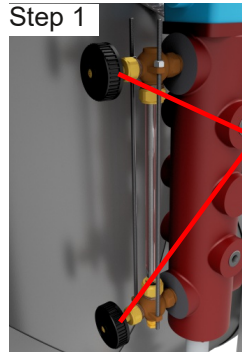

Close gauge glass valves (Top and Bottom)
Remove gauge glass protector & rods

Step 2

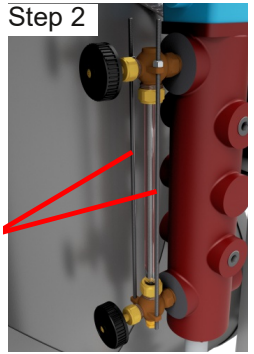

Step 3

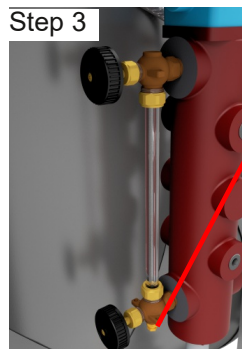

Open drain valve on bottom fixture to drain glass
Loosen nuts at top and bottom of glass

Step 4

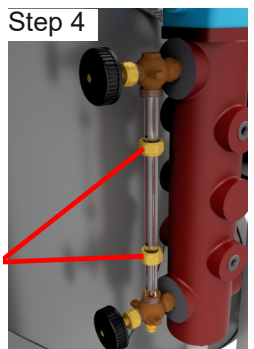

Step 5

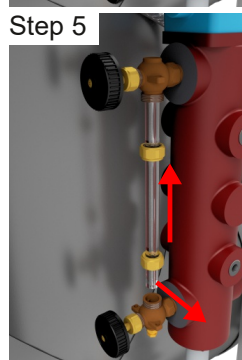

Slide glass up, pull out on bottom of glass and remove

Step 6

Install new glass by performing the above procedure in reverse order. Always install new rubber washers.

4. Troubleshooting



WARNING Ensure that the boiler is cold and has no pressure.
Electrical trouble shooting must be performed by a qualified electrician.

Boiler Status	Quick Fix
POWER switch on boiler controller turned on, but no lights lit on the front panel of the boiler controller	<ul style="list-style-type: none"> - Check circuit breaker or fuse of the wall outlet where the boiler control voltage circuit is hooked up to. If the circuit breaker is tripped or the fuse blown, check whether other appliances are plugged into outlets that are fed by the same circuit breaker/fuse. If that is the case, then plug those other appliances into outlets that are protected by other circuit breakers or fuses.
LOW WATER alarm light on boiler controller panel lit:	<ul style="list-style-type: none"> - Press the LOW WATER reset button - Check Water Level. Water level must be visible in gauge glass. - Ensure that the boiler is filled with Tap water and not distilled or de-mineralized water. - Check the probe wires for continuity - Check feed water pump and/or solenoid valve for proper operation
HIGH PRESSURE alarm light on boiler controller panel lit:	<ul style="list-style-type: none"> - Press the HIGH PRESSURE reset switch - If the pressure gauge indicates steam pressure above the preset value, reduce pressure and press the HIGH PRESSURE reset switch again. - Check operating pressure switch for proper operation
Unit won't build up pressure when POWER switch is on, boiler filled to nominal water level with water and HEATING light on the boiler controller is lit.	<ul style="list-style-type: none"> - Voltage Test: Read voltage across each element. If no voltage reading, check the voltage before and after the element contactor. If no voltage before the contactor, check fuses in fused disconnect switch. If no voltage reading after the contactor and contactor pulled in, replace contactor. If voltage reading after the contactor, go to Amperage Test. - Amperage Test: Read amperage on each element wire. If no amperage reading on one or more element wires, replace heating elements.
Pump and/or solenoid valve energized, but no water enters the boiler	<ul style="list-style-type: none"> - Check water inlet strainer - Check whether the water feed shutoff valve is open
Boiler overfills or floods	<ul style="list-style-type: none"> - Check water feed solenoid valve for sticking - Check the probe wires to the boiler controller for continuity - Check feed water. Boiler won't operate with distilled or de-mineralized water
Fuse blown	<ul style="list-style-type: none"> - Short circuit or overload has occurred. Before replacing fuse, locate the short circuit or overload. - Poor contact between fuse and fuse clips can cause fuse to blow. If surface that makes contact with the fuse clips is discolored, fuse has been making poor contact with the clips. Installing a larger fuse will not help. Replace the fuse holder.
Contactor(s) don't pull in	<ul style="list-style-type: none"> - Ensure that the contactor coil is receiving proper voltage - If contactor pulls in but chatters, clean magnetic core of contactor - Further problems would indicate mechanical difficulties within the contactor. - Complete contactor replacement is usually the least expensive solution
"REFILLING" light on the boiler controller is lit, but feed water pump or solenoid valve not energized	<ul style="list-style-type: none"> - Check for proper contact of the pump power cord to the receptacle

If trouble shooting did not resolve problem, please contact our service technicians at:
 Phone: 540-662-3811
 Email: techsupport@reimersinc.com

5. Parts list for RV, RVH and RVHC Boiler Models



WARNING

Use Reimers replacement parts. All components are designed and approved to be used in this Underwriters Laboratories listed and ASME National Board Stamped boiler. Failure to do so may cause serious injury or death.

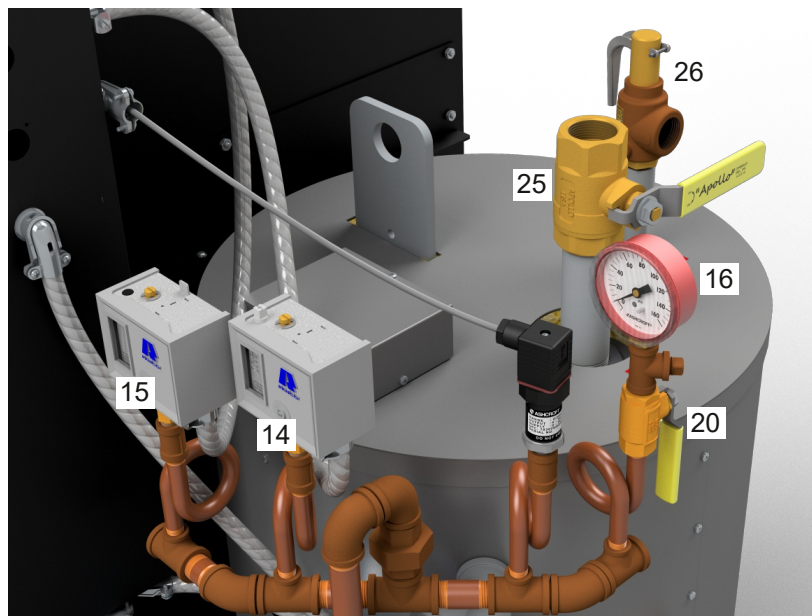
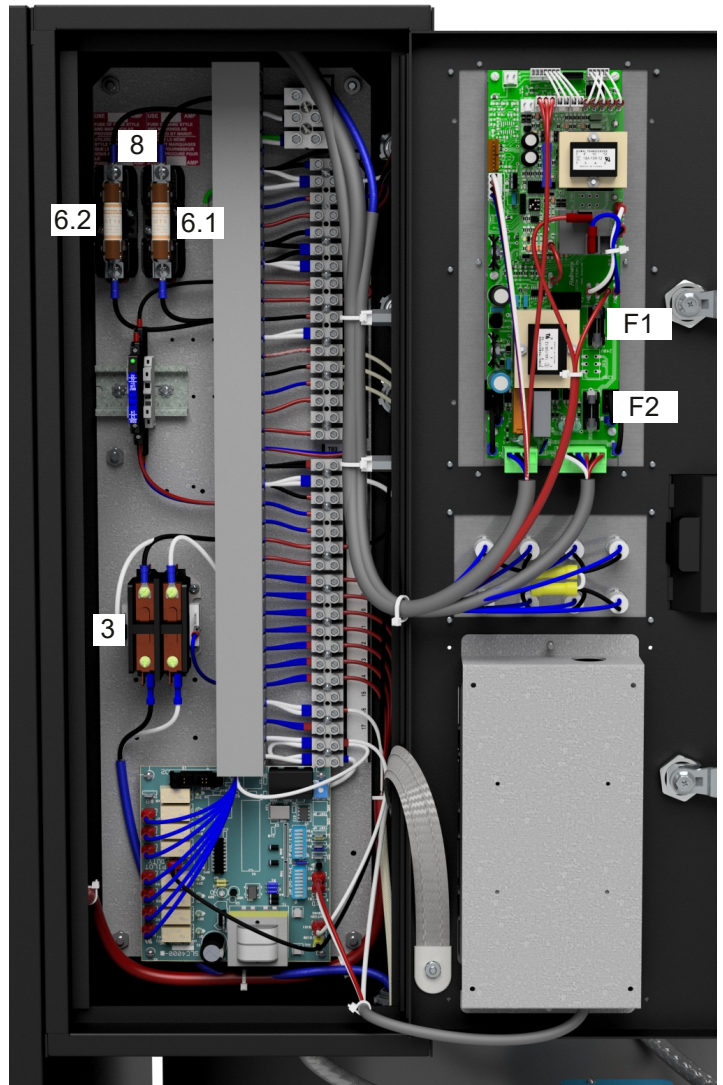
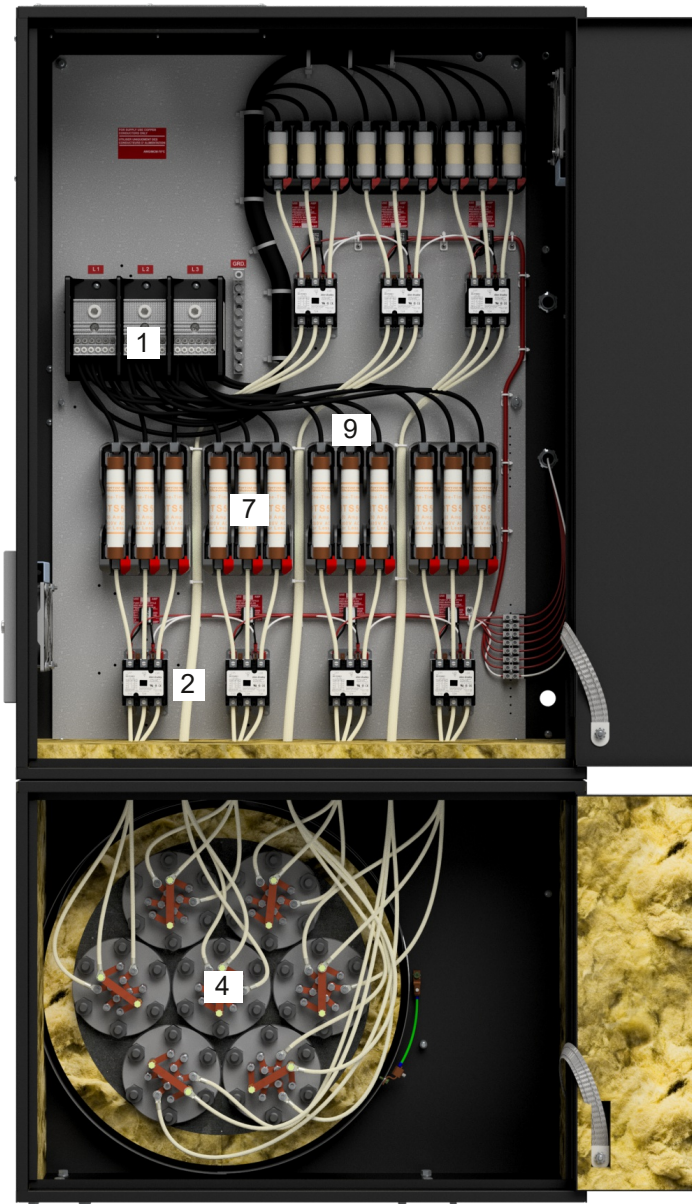

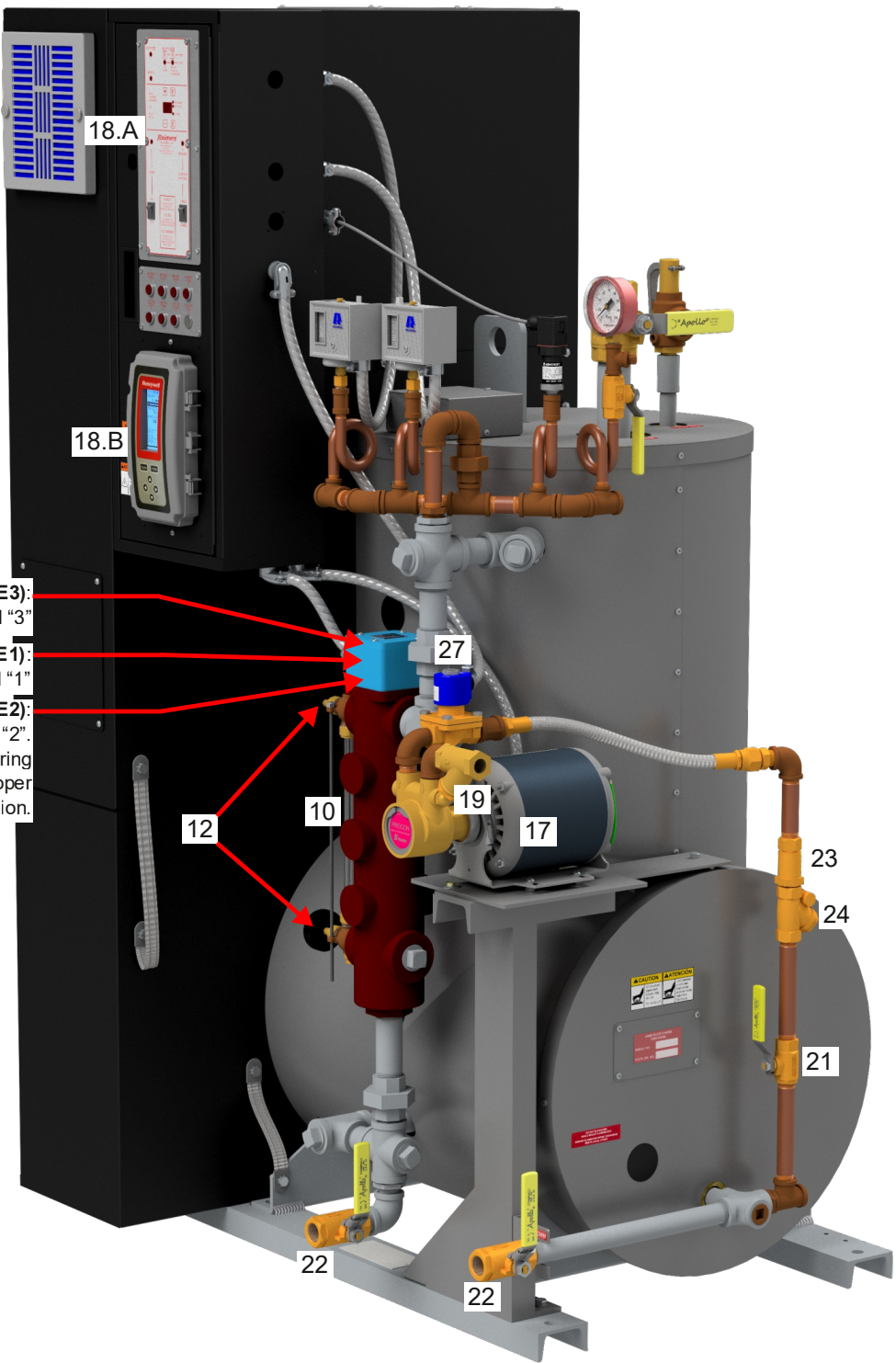
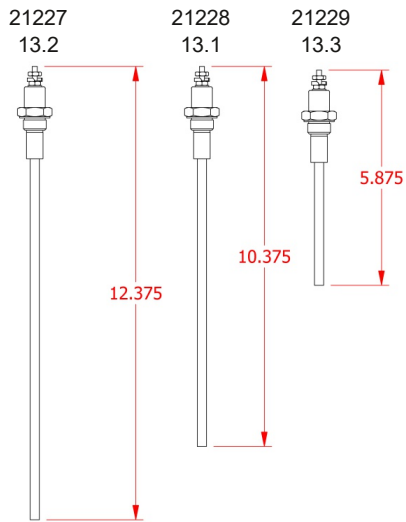

- 13.2 Low Water Cut-Off Probe (E3):
Connect this probe to wire marked "3"
- 13.1 Automatic Refill Probe (E1):
Connect this probe to wire marked "1"
- High Water Level Cut-Off Probe (E2):
Connect this probe to wire marked "2".
- 13.3 Please refer also to the boiler wiring
diagram and Figure 12 for proper
probe identification.

Ref. No.	Wiring Diagram Ref.	Part No.	Description
1	E1	02616 02618 02619	BLOCK POWER DISTRIBUTION 3-2/0 BLOCK POWER DISTRIBUTION 3-500 BLOCK POWER DISTRIBUTION 3-500
2	K1-7	02530 02539 02597	CONTACTOR 50A 120V 3P UL/CSA CONTACTOR 75A 120V 3P UL/CSA CONTACTOR 93A 120V 3P UL/CSA
3	K40	03445	CONTACTOR 35A 120V 2P UL/CSA
4	HR1-7	05384 05389 05631 05632 05633 05634 05635 05379 05380 05381 05382 05383	ELEMENT 208V, 10KW ELEMENT 600V, 10KW ELEMENT 208V, 15KW ELEMENT 240V, 15KW ELEMENT 380V, 15KW ELEMENT 480V, 15KW ELEMENT 600V, 15KW ELEMENT 208V, 20KW ELEMENT 240V, 20KW ELEMENT 380V, 20KW ELEMENT 480V, 20KW ELEMENT 600V, 20KW
5		05390	FLANGE GASKET 5.25" RING
6.1 6.2	F60 F61	02655 02125	FUSE 250V 5A CLASS K5 FAST-ACTING UL/CSA FUSE 250V 15A CLASS K5 FAST-ACTING UL/CSA
F1 F2	F1 F2	05082 05081	FUSE 250V 80mA TIME DELAY UL/CSA FUSE 250V 160mA TIME DELAY UL/CSA
7	F1-21	02128 02127 02127 02129 02130 02453 02134 02135 02518 03349	FUSE 250V 40A FUSE 250V 50A FUSE 250V 60A FUSE 250V 80A FUSE 250V 100A FUSE 600V 20A FUSE 600V 30A FUSE 600V 40A FUSE 600V 50A FUSE 600V 80A CLASS J
8		02140	FUSE BLOCK 250V 30A 1P
9		02142 02144 02150 02613 02614 03770	FUSE BLOCK 250V 60A 3P FUSE BLOCK 250V 100A 3P FUSE BLOCK 250V 30A 2P FUSE BLOCK 600V 30A 3P FUSE BLOCK 600V 60A 3P FUSE BLOCK 600V 100A 3P
10		05596	GAUGE GLASS 10.125" X 0.625"
11		02006 02448	GAUGE RUBBER WASHER FOR .625" GLASS WASHER BRASS
12		02396	WATER GAUGE FIXTURE SET
13.1 13.2 13.3	LLCO PROBE REFILL PROBE HIGH LEVEL PROBE	21227 21228 21229	LEVEL PROBE LOW WATER CUTOFF LEVEL PROBE AUTOMATIC REFILL LEVEL PROBE HIGH LEVEL CUTOFF
14	S2-3	04162 04163 05664	PRESSURE CONTROL 14# OPERATING (TECMARK) PRESSURE CONTROL 80# OPERATING (TECMARK) PRESSURE CONTROL 80# OPERATING (RANCO)
15	S1	05077 04296 05665	PRESSURE CONTROL 13.5# HIGH LIMIT(TECMARK) PRESSURE CONTROL 90# HIGH LIMIT (TECMARK) PRESSURE CONTROL 90# MANUAL RESET (RANCO)

16		02451 02329	PRESSURE GAUGE 2.5" 30# PRESSURE GAUGE 2.5" 160#
17	B1	05009 05008 05694 02360 02640	MOTOR 1/3 HP 115V 1P 60HZ PUMP 140 GPH PUMP 215 GPH PUMP 1/3 HP 115-230V 1P 60HZ PUMP 3/4 HP 208-230/460V 3P 60 HZ
18.A	A1	20838	BOILER CONTROLLER
18.B	A3	05048	PID-CONTROLLER HW (135-210KW ONLY)
19		03325	STRAINER 0.5" "Y" (135-210KW ONLY)
20		02472	VALVE BALL 0.25" NPT
21		02490	VALVE BALL 0.5" NPT
22		03802	VALVE BALL 0.75" NPT W/ LATCH
23		02692	VALVE CHECK BALL CONE 0.5" NPT
24		02462	VALVE CHECK 0.5" NPT SWING
25		02514 02515 03209 02464 05852 05870	VALVE BALL 3/4" SWP 200# VALVE BALL 1" SWP 200# VALVE BALL 1-1/4" SWP 200# VALVE GLOBE 1.5" NPT BRZ 200# VALVE BALL 2" NPT BRZ 200# WSP VALVE BALL 2.5" NPT BRZ 150#
26		02636 02638 02637 02010 02641	SAFETY VALVE 1/2" 50# SAFETY VALVE 1/2" 75# SAFETY VALVE 1/2" 100# SAFETY VALVE 3/4" 15# SAFETY VALVE 3/4" 75#
27		02301	SOLENOID VALVE 1/2" 120V

Instruction Supplement 1

Condensate Return System

I1. Installation

Step 1: Connect water supply to water intake on tank (1). If the city water line pressure exceeds 40psi, install a pressure reducing valve.

⚠ WARNING Water supply should be turned off when the boiler is not in operation.

Step 2: Connect the condensate return line from the equipment to the condensate return intake (2). Pipe from the vent (3) is to be installed to outside of the building, if desired. If this method is used, the pipe should be the same size as the vent opening.

⚠ WARNING Under no condition should the vent be plugged.

Step 3: Install piping from the overflow (4) to a drain.

I2. Startup

Step 1: Turn all boiler power supplies on.

Step 2: Open the water supply valve to begin filling the condensate tank with water. Observe the water level in the tank gauge glass. When the float valve inside the tank closes, the water level should be still visible in the upper portion of the gauge glass.

Step 3: Open the boiler steam outlet valve (9).

Step 4: Ensure that the feed water shutoff valve (5) and the condensate pump supply valve (6) are in the open position.

Step 5: Flip the POWER-switch (not shown) to the ON position. The pump should turn on.

Step 6: Open the pump primer valve (8) slightly and wait until water discharges. Close this valve.

Step 7: Wait until the pump stops. After the pump has stopped, the water level in the boiler gauge glass should be at approximately half height of the glass.

Step 8: Close the steam outlet valve (9) and wait until the boiler builds up pressure to its preset value.

Step 9: Open slowly the steam outlet valve (9) to supply steam to the process.

I3. Maintenance

a. Strainer – The strainer (10) should be removed and cleaned shortly after boiler has been in operation to clear away sediment, which may have accumulated during start-up. This strainer should be periodically inspected and cleaned when necessary.

b. Gauge Glass - See Boiler Instructions.

c. Pump Motor - Maintenance is normally not required on the pump or motor (11).

I4. Condensate Return System Parts List

Part# Description

05592 Gauge Glass 5/8" X 5.75"

02001 Gauge Glass Fixture Set

05846 Strainer 1"

Part number for pump depends on boiler model

Vertical Condensate Return Tank:

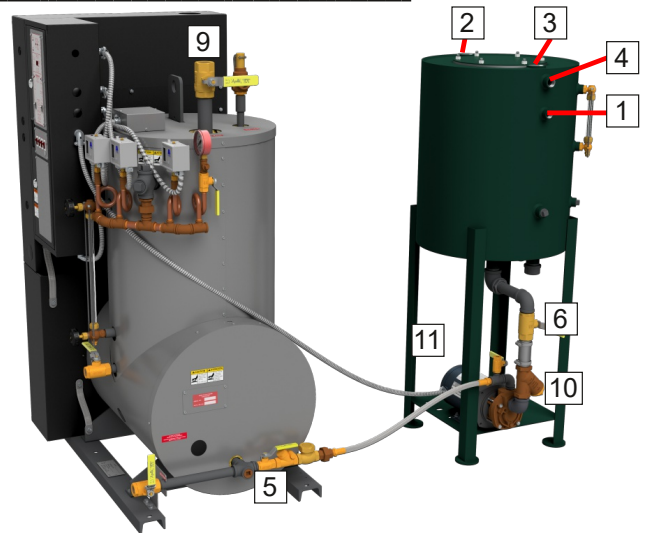

PRESHIPMENT PARTS QUALITY VERIFICATION

Component: RV Heating Elements Part Numbers: 21095

Objective: Assure strapping is applied in proper orientation. If not aligned proper it will alter KW of element and imbalance KW loads on power feeds.

Instruments and Tools Required: Nut driver, 30 in-lb torque driver, washers, star washers, nuts, straps.

Method: Lay element on work bench or secure in fixture. Flange must be oriented as shown with center rods 2A and 2B laying horizontal. Strapping is to be applied or removed per one of the arrangements on dwg 21095 to meet boiler voltage and KW requirements. In some cases a jumper wire may be used in place of a strap.

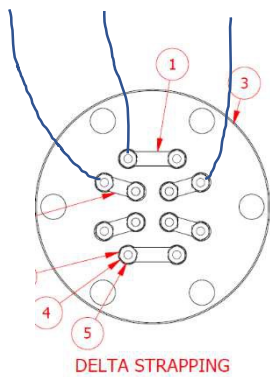
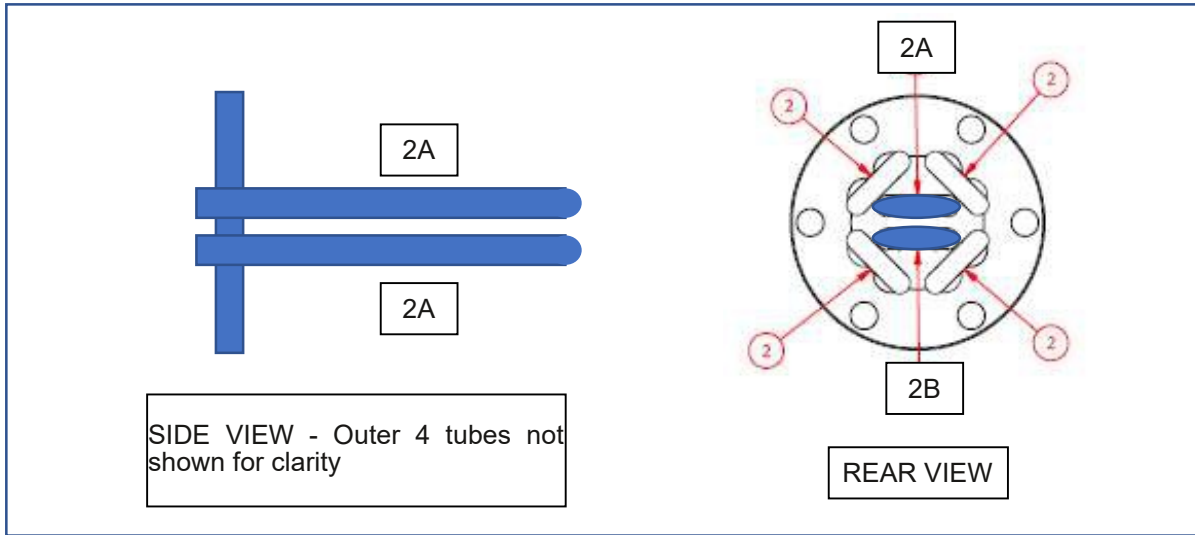

15 KW

208/240/480 V 3φ

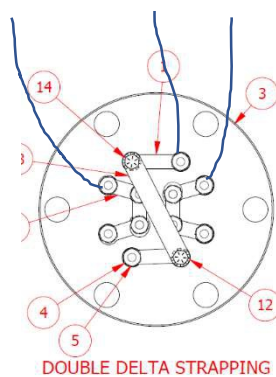

30 KW

208/240/480 V 3φ

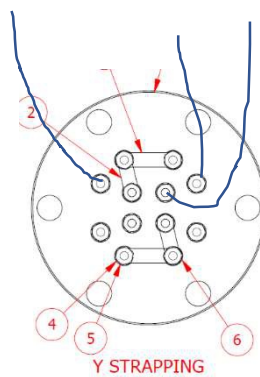

30 KW

600 V 3φ

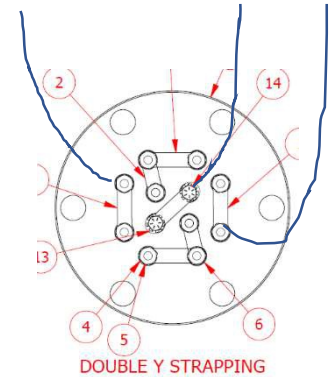

30 KW

600 V 3φ

FRONT VIEWS Reference Dwg 21095