

puzzi.

circular soft seating solutions

Table of Contents.

Introduction	3
Collaboration	5
Puzzl system	6
Upholstery	9
Puzzl Tessella	10
Technical Specifications: Tessella	12
Puzzl Shard	13
Technical Specifications: Shard	15
Puzzl Pieces	16
Inspiration: Pieces	17
Closing the lopp	18
Contact	20

Most furniture ends up as waste.

It doesn't have to be that way.

The furniture industry produces millions of tonnes of waste every year. Conventional seating is built from mixed materials, glued, stapled and layered together, making disassembly, repair and recycling virtually impossible. When a sofa wears out, it goes to the incinerator. The raw materials inside it go with it. As a result, enormous quantities of high-quality material are lost. PU foam and latex from old sofas, seating elements and mattresses. EPS foam from electronics packaging and discarded refrigerators. Materials with real structural and functional value, simply because no one has found a way to use them again.

The problem is not a lack of material. It is a lack of design thinking that puts circularity first.

Design for disassembly by Circular Laboratory of Innovations®

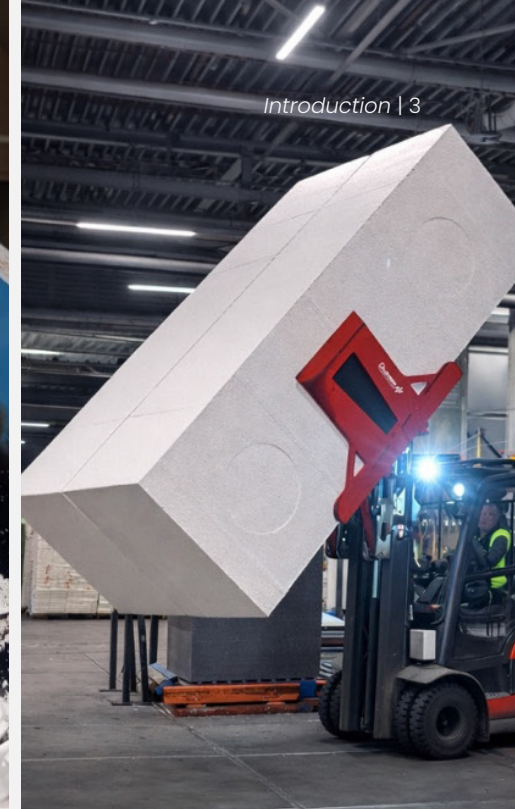



Waste rediscovered as a raw material for high-quality seating.

The circular design principles of the Puzzl soft seating collection are built on two developments that reinforce each other. On one hand, materials innovation that responds to what the world throws away. Old PU foam and latex from dismantled seating and EPS from electronics packaging and old refrigerators are recycled and reprocessed into high-quality structural and comfort materials. Without compromise. Material that meets the demands of commercial contract furniture, made from almost exclusively recovered waste streams. On the other hand, designed so that it never becomes waste again. Every component of the Puzzl is modularly constructed and engineered to be taken apart quickly and easily. No glue, staples or mixed materials. Just four clean mono-materials that separate simply, so that the value put in at the start is preserved at the end.

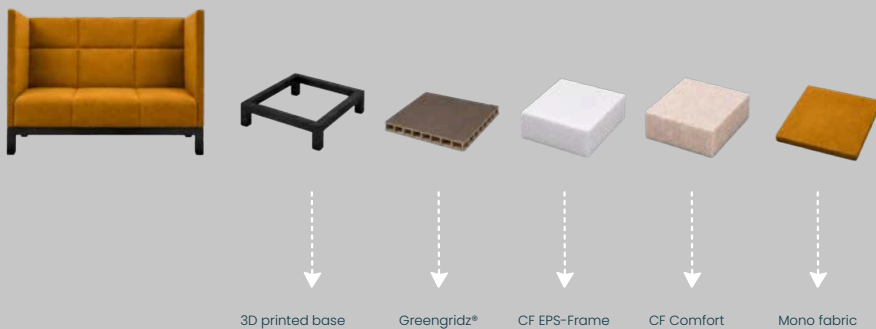

3D printed base

Greengridz*

CF EPS-Frame

CF Comfort

Mono fabric

TRIBOO chooses CircleFoam Inside.

Circular design starts with the right mindset and material choices.

That is why TRIBOO chooses CircleFoam Inside. Together, TRIBOO and CircleFoam make short work of waste. No waste, no compromises — just a circular solution that works. With the Puzzi soft seating collection, groundbreaking design and innovation are brought together into one powerful product that is ready for a future without waste.

Sustainable, scalable and immediately applicable. This is what circular design looks like.



From waste stream to structural material.

CircleFoam's technology processes post-consumer and industrial EPS into solid CircleFoam blocks. A rigid, lightweight structural material that serves as the base material for the frame of the Puzzl seating elements. Recycled PU foam and latex are processed into CircleFoam Comfort. A high-quality foam that guarantees comfortable seating. These stray raw materials that had ended up as waste are given a new purpose and perform perfectly in heavily used environments.



Modularly built as an endless raw material for seating.

The Puzzl is modularly designed and built. Constructed from four mono-materials: CF-rEPS frame, CF-Comfort foam, Greengridz® and fabric. The upholstery is applied without glue or staples and every connection is reversible. The seating elements can be taken apart easily without tools, glue or specialist knowledge. As a result, at the end of its lifespan every mono-material can be recycled at a high quality level and serve again as raw material for the next Puzzl.



Puzzl modular seating, made from waste, built to last, designed to return.

Puzzl is a modular seating system for work environments and public spaces – from offices and schools to retail, hospitality and hotels – that facilitates meeting, focus and collaboration, and adapts effortlessly to the needs and evolution of the space.



What each model is made of:

Upholstery: no glue or staples.

Mono-material fabric is applied without glue or staples. Fully demountable for reupholstering or replacement. Alternative upholstery is available on request.

Seat & back: CircleFoam Comfort

100% recycled PU foam and latex, sourced from old furniture and mattresses and from industrial cutting waste. The right choice of foam qualities for each application is made by our own specialists.

Frame: CircleFoam Frame (rEPS)

Strong, rigid and lightweight. Made from recycled EPS, clean protective and packaging material, collected via municipal waste sites.

Base panel: Greengridz[®]-furniture construction panel

Lightweight structural furniture panel. Feet or plinth are 3D-printed from waste EPS. The entire base is designed for clean separation and recycling.



Upholstery options.

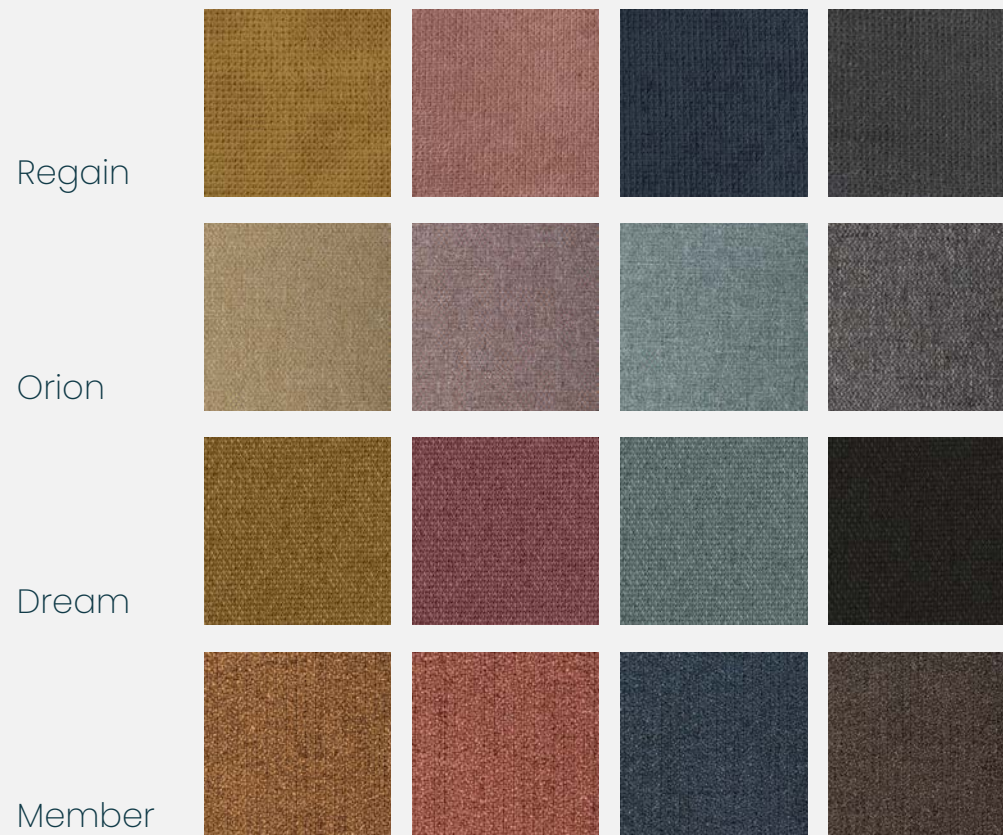

All our sofas can be upholstered with the REGAIN, ORION, DREAM, and MEMBER fabric collections from FABRAA.

Puzzi Tessella.

The bench from the Puzzi family is designed for the circular economy and proves how waste can transform into a high-quality interior element.

In work environments and public spaces, this aesthetically refined seating is versatile in its application. Puzzi is comfortable and facilitates meeting, collaboration and spontaneous interaction.

Thanks to the modular design, elements from the Puzzi family move effortlessly with the dynamics of the space. Compact, flexible and fully configurable to your needs. Do requirements change? Simply adapt the layout.

Made from recycled materials and developed with CO₂ reduction as its starting point, Puzzi is not only a smart choice for your interior – but also for the future.

Product specifications on page 12.





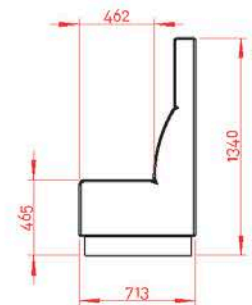
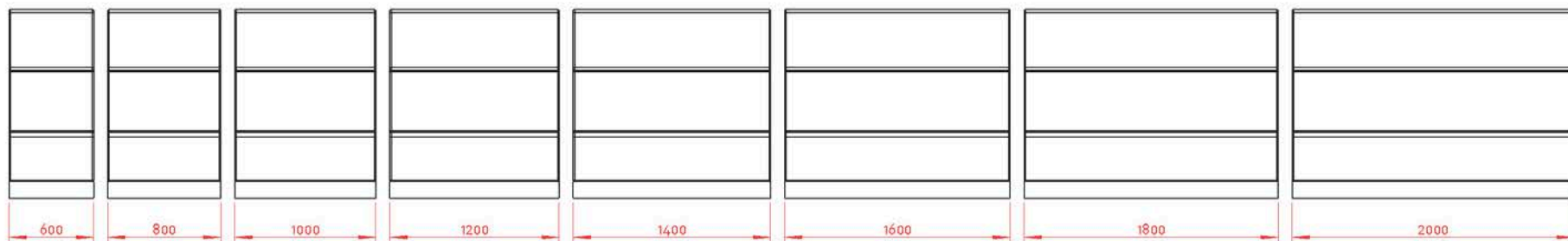
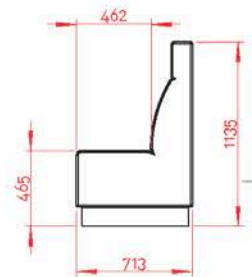
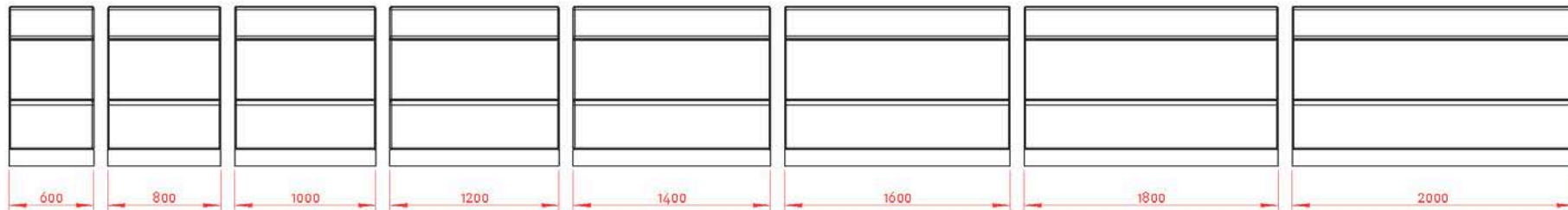
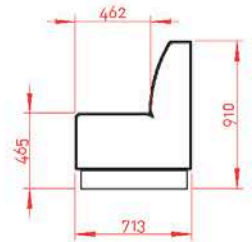
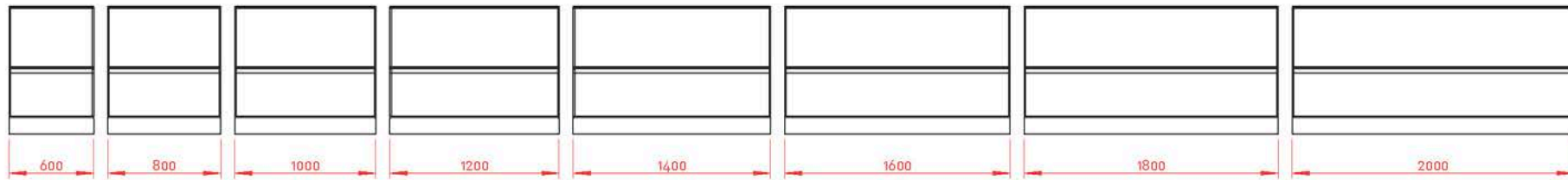

Puzzl Shard.

Simplicity, lightweight construction and space efficiency are the design principles behind the comfortable seating elements of the Puzzl Shard. Ideal for use in limited spaces such as booths, pods or alcoves, where the lightweight construction finds stability by leaning against a wall. This makes the Shard elements compact, allowing circulation and usable space to be maximised.

The modular seating elements do not need to be anchored and are easy to reposition thanks to their low weight. This provides flexibility and fits within dynamic, ever-changing office environments. Because the seating does not need to be fully self-supporting, less material is required and the CO₂ footprint is significantly lower.

The Puzzl Shard proves how waste can transform into a high-quality interior element. The circular focus in the design ensures that only what is truly necessary is added. The Shard is not only a smart and sustainable choice for your interior – it also makes a practical contribution to a future without waste.

Product specifications on page 15

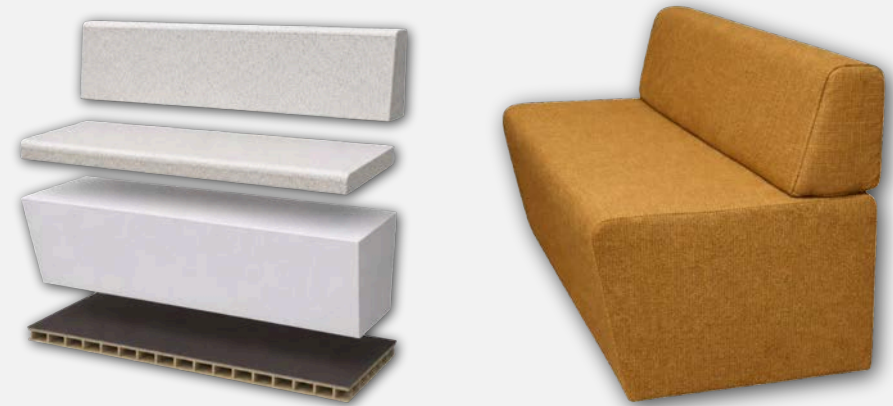



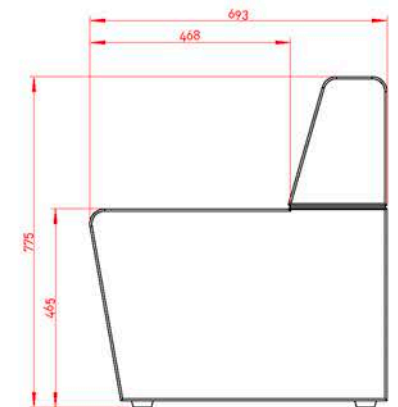
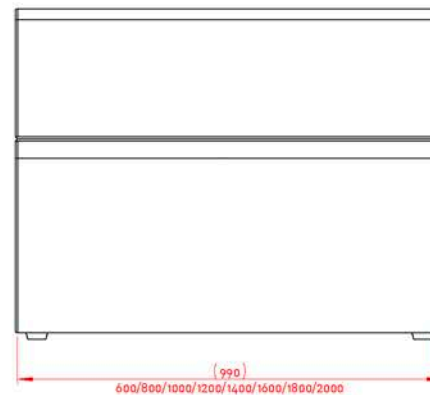
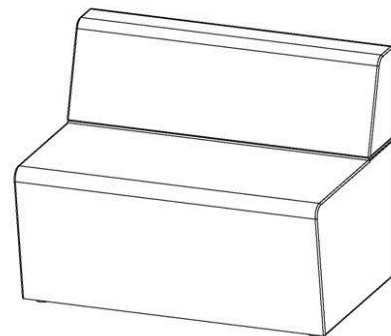
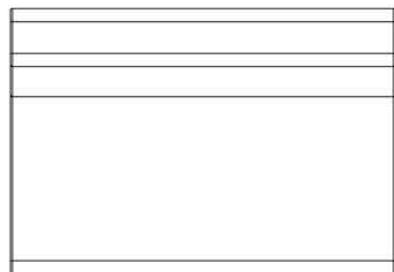
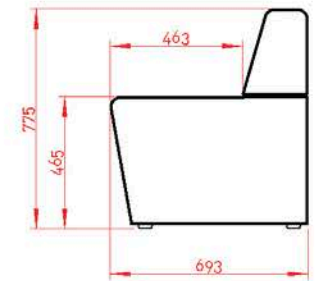
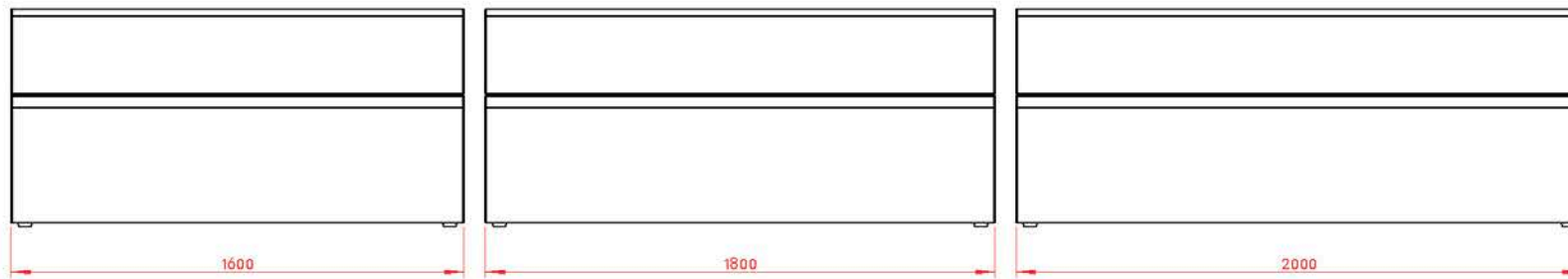
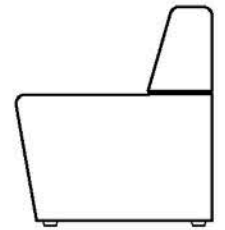
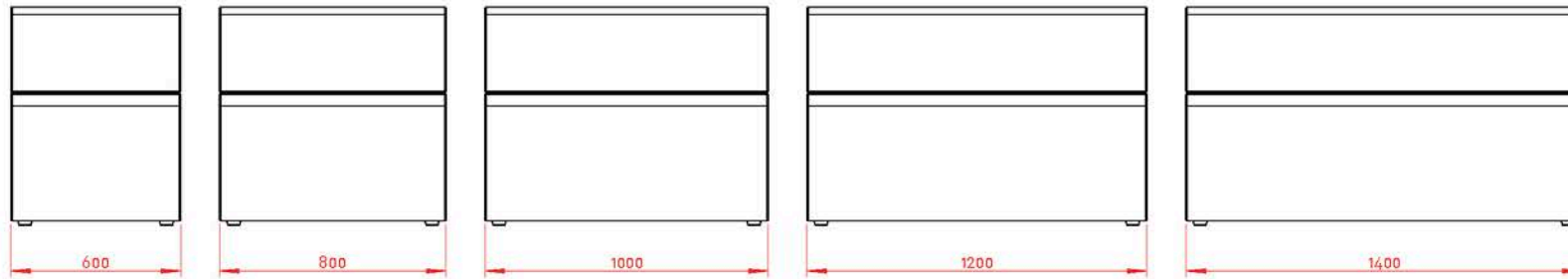

(990)
600/800/1000/1200/1400/1600/1800/2000

Puzzl Pieces.

The Pieces seating elements from the Puzzl family are modularly designed as a system of smart puzzle pieces. Individual elements that you configure yourself into a comfortable lounge furniture piece, tailored precisely to your space, use and atmosphere.

With Puzzl Pieces you create inviting places to relax, meet and be together. In lounges, reception areas and open work environments. Each element connects to the next. Just like a puzzle, the pieces form a whole together, while remaining flexible for individual use. Today a quiet seating corner, tomorrow an open lounge arrangement or a playful island shape. Adapting is simple, without new furniture, without waste.

The Puzzl Pieces prove how waste can transform into high-quality interior elements. Through the circular focus in the design on recycled materials and the reduction of CO₂ emissions, the Puzzl Pieces are not only a smart and sustainable choice for your interior, but also make a practical contribution to a future without waste.

Inspiration on page 17





Return it. Refurbish it. Or let us close the loop.

When your Puzzl reaches the end of its useful life, return it to TRIBOO. Pieces in good condition are refurbished and redeployed. At the true end of its lifespan, every material is recovered for high-quality recycling and used as raw material for the next generation of Puzzl.

As recognition of the investment you have made in a circular product, TRIBOO pays €0.25 per kilogram on return.

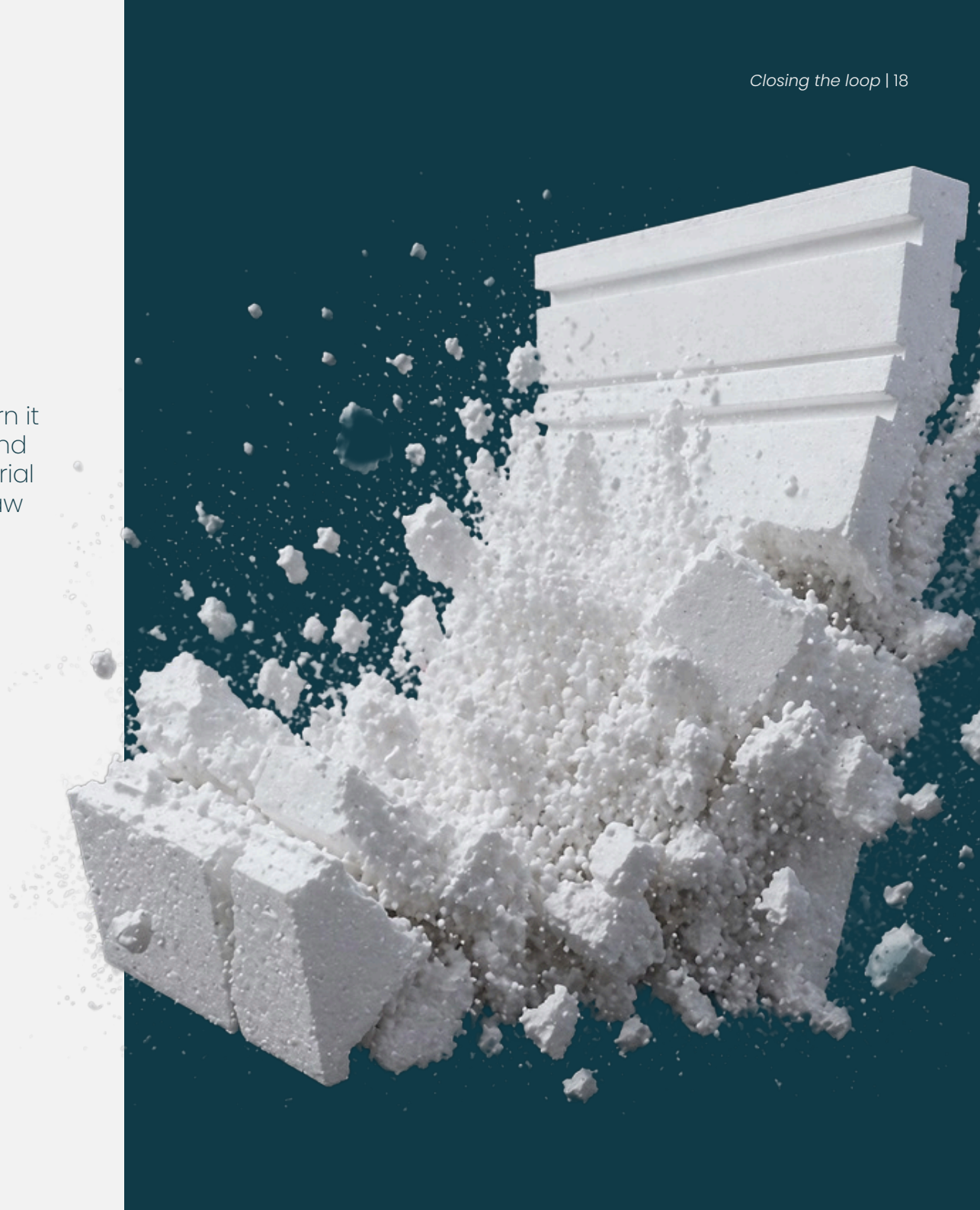

We don't sell furniture, we solve problems.

Let's get moving together.

Our professional team is ready to support you with expert advice, circular expertise, and a hands-on approach. Together, we design your project using fewer materials, less CO₂ emissions, and less waste. Build with us toward a future without waste and make the circular economy visible to everyone in your space.

Get in touch using the details below or visit our showroom.

Email: info@triboo.eu

Phone: (+31) 085 025 0063

Address: Nijverheidscentrum 2, 2761JP, Zevenhuizen

Website: www.triboo.eu

