

MULTI

DESKING



III
R
GO



Make it your own

*With the adaptability of changing it later

Ergoform's Multi Desking Range offers unparalleled flexibility in creating your ideal workspace. From single desks to clusters of up to 14 or more, our Multi Range adapts to meet your unique requirements. We understand that every client's needs are different, and with our Multi Desking Range, you have the power to configure your workspace exactly the way you envision it.

1. Desk

Select predefined table configurations

DBL

4 way



4 way



6 way



8 way

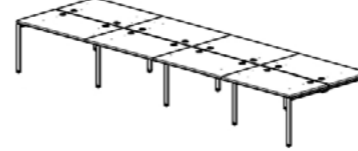

SGL

Single



2 way



3 way



4 way

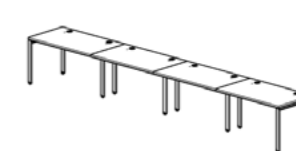

2. Accessories

Panel

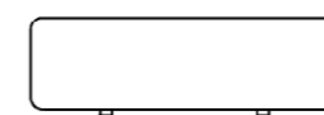

Privacy Screen

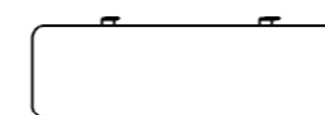

3. Power

Plug Points

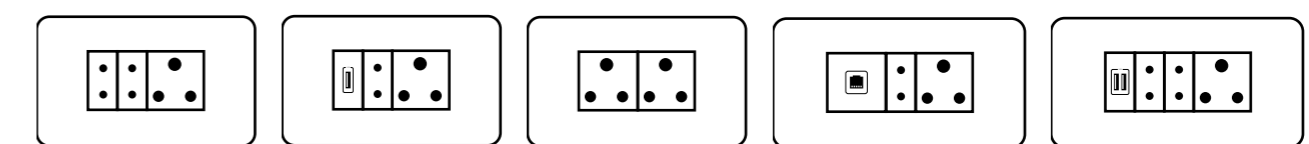

4. Vertical Reticulation

Center Leg



5. Horizontal Reticulation

Cable Basket



Multi A

Creative Edge

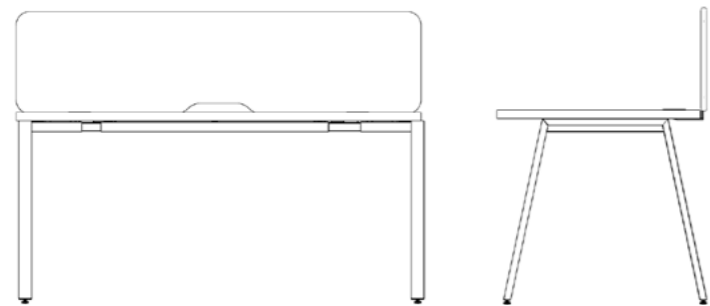

The Multi A desk boasts a daring design with slanted metal end legs that set it apart from traditional office desks. Its edgy appearance adds a unique touch to any workspace, creating a dynamic and vibrant atmosphere.

The Multi A desk stands out with its edgy appearance. Its defining feature is the slanted metal end legs that not only provide stability but also create a sense of dynamism in your workspace. The sleek and modern design of this desk is perfect for those who wish to break away from the traditional, grid-like office environment. The metallic finish adds a touch of sophistication that complements contemporary office aesthetics.

Multi A is designed for those seeking a fresh and vibrant workspace. The edgy design of this desk

makes it ideal for creative environments where innovation thrives. It offers versatile functionality and can be used in open-plan offices, co-working spaces, or modern creative studios. Whether you're a startup looking for a unique workspace or a design studio seeking an edgy yet functional work environment, Multi A caters to your needs, adding a spark of creativity to your daily routine.



Multi.

The beauty of Ergoform's Multi Range extends beyond its functionality. Our range features a variety of interchangeable end legs that allow you to transform the look of your workspace effortlessly. Whether you prefer the edgy appeal of the slanted metal end legs, the classic charm of wooden legs, or the sleek modern minimalistic design, the Multi Range offers a solution that suits your style.

SGL

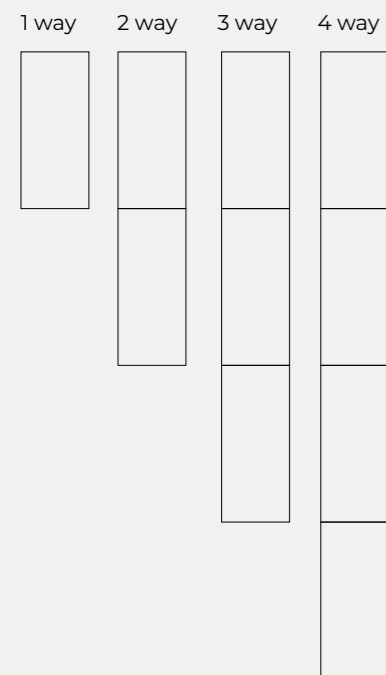

DBL

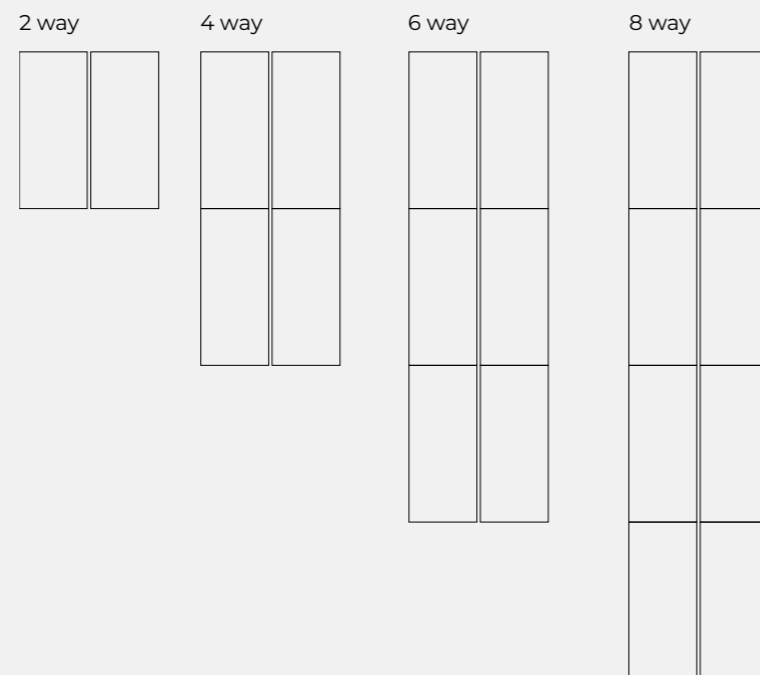





Standard Finishes

MDF Sprayed any Dulux or plascon colour / Melamine / Veneer

Melamine

Standard colours















-  Storm Grey
-  White
-  Folkstone Grey
-  Brookhill Woodgrain

Leg Finishes

Sprayed any Dulux or plascon colour

Plascon/Dulux

Ergoform Standard colours

-  Glacier
-  Stone
-  Nude
-  Mint
-  Sand
-  Ocean
-  Vision
-  India
-  Moss
-  Ochre
-  Safira
-  Onyx
-  Brick
-  Forest
-  Camel



Slim

SGL

1 way	585mm	1350mm
2 way	585mm	2700mm
3 way	585mm	4050mm
4 way	585mm	5400mm

DBL

2 way	1200mm	1350mm
4 way	1200mm	2700mm
6 way	1200mm	4050mm
8 way	1200mm	5400mm

Econo

SGL

1 way	785mm	1350mm
2 way	785mm	2700mm
3 way	785mm	4050mm
4 way	785mm	5400mm

DBL

2 way	1600mm	1350mm
4 way	1600mm	2700mm
6 way	1600mm	4050mm
8 way	1600mm	5400mm

Standard

SGL

1 way	785mm	1600mm
2 way	785mm	3200mm
3 way	785mm	4800mm
4 way	785mm	6400mm

DBL

2 way	1600mm	1600mm
4 way	1600mm	3200mm
6 way	1600mm	4800mm
8 way	1600mm	6400mm

These are our standard size desk tops. These sizes are optimized for the most economic cuts which reduce cost and waste. We are able to customise desks, contact our sales team for more information.

