User Manual



Table of contents



1. General description	3
2. Technical specifications	4
3. Sensors	5
4. Indicators	7
5. Levels and Recommendations	12
6. Installation	15
7. Configuration	16
8. Device operation	18
9. My inBiot Platform	21
10. Calibration	22
11. Safety instructions	23

1. General description



MICA is a smart monitor that continuously measures indoor air quality. This device can measure up to 12 parameters: temperature, humidity, carbon dioxide (CO₂), volatile organic compounds (TVOC), suspended particles (PM10, PM4.0, PM2.5, and PM1.0), formaldehyde, ozone (O₃), nitrogen dioxide (NO₂), and carbon monoxide (CO).

The device wirelessly communicates with the My inBiot web platform where the user can see how the indoor air quality is within a specific time period, check historical values, and obtain useful information about each of the measured parameters.

Moreover, with our MICA device, you can view real-time air quality updates through our control panel and weekly reports and receive alerts, advice, and insights on managing indoor air quality when issues arise.

There are four current device models: MICA WELL, which measures all the parameters; MICA Plus, which measures all parameters except O₃, NO₂, and CO; MICA, which measures temperature, humidity, CO₂, PM2.5, PM10, and TVOC; and MICA Mini, which measures temperature, humidity, and CO₂.

Each of these models is available in two versions: Desktop, which is designed to sit on a desk or flat surface and connect via USB-C, and the wall version, designed to be installed in a recessed electrical box or directly mounted to the wall and is connected to AC power or PoE (Power over ethernet).



2. Technical specifications



Features

Multifunction touch button.
Customizable status light ring.
USB type C connector.
Wi-Fi Connectivity.*

Dimensions and weight

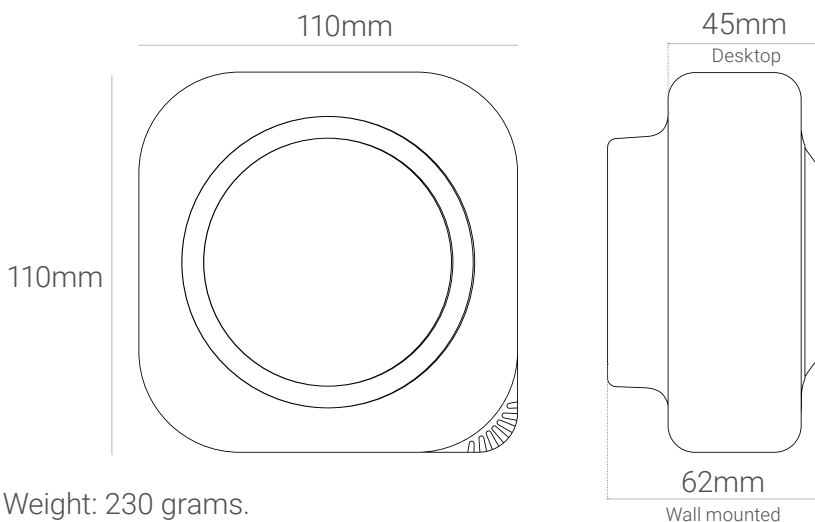

Weight: 230 grams.

Power supply options **

USB type C cable + EU 5V USB power adapter (for desktop only).
Alternating current 110 - 240V 50-60 Hz 0.2A fast connector.
Direct current 8 - 36V 2A 10W fast connector.
PoE (802.3af and above) 54VDC 12.95W RJ45 connector.

Other connectivity options **

LoRaWAN.
Sigfox.
NB-IoT / LTE-M.
Ethernet.

Local communication options **

Modbus RTU (RS-485).
Modbus TCP/IP (wireless) .
BACnet IP
API.
MQTT.

* The device can only connect to 2.4 GHz WiFi networks with 802.11 b/g/n (802.11n up to 150 Mbps) protocols. Supported authentication and security protocols: WPA2 (Personal), WPA2 Enterprise, WPA3 (Personal), and WPA3 Enterprise.

** Connectivity other than Wi-Fi, power supply other than USB type C and any local communication option must be specified and requested by the customer.

3. Sensors



Temperature

Sensor: Silicon bandgap / Unit: °C
Range: -40 - 125 °C / Resolution: 0,1 °C
Accuracy: ± 0,5 °C
Lifespan¹: >10 years
Recommended conditions: 5°C - 60°C and 20%RH - 80%RH
Maximum operating conditions: -40°C - 125°C and 0%RH - 100%RH

Relative Humidity

Sensor: Capacitive / Unit: %RH
Range: 0 - 100 %RH / Resolution: 1 %RH
Accuracy: ± 2 %RH
Lifespan: >10 years
Recommended conditions: 5°C - 60°C and 20%RH - 80%RH
Maximum operating conditions: -40°C - 125°C and 0%RH - 100%RH

CO₂

Sensor: NDIR / Unit: ppm
Range: 400 - 10.000 ppm / Resolution: 1ppm
Accuracy: ±(30 + 3% m.v.) ppm
Lifespan: >10 years
Recommended conditions: 0°C - 50°C and 0 - 85%RH
Maximum operating conditions: -10°C - 50°C and 0 - 95%RH

TVOC

Sensor: MOx / Unit: VOC Index Points (µg/m³ or ppb)*
Range: 0 - 500 VOC Index Points (0 - 1000 ppm) /Resolution: 1 VOC Index Points
Accuracy: ±15 VOC Index points or ±15% m.v., whichever is larger
Lifespan: >10 years
Recommended conditions: 10°C - 40°C and 20 - 80%RH
Maximum operating conditions: -10°C - 50°C and 0 - 90%RH (non-condensing)

PM_{2,5}

Sensor: Particle laser / Unit: µg/m³
Range: 0 - 1.000 µg/m³ / Resolution: 1 µg/m³
Accuracy: ± (5 µg/m³ + 5% m.v.) (0 -100 µg/m³), ±10% m.v. (101-1000 µg/m³)
Lifespan: >10 years
Recommended conditions: 10°C - 40°C and 20 - 80%RH
Maximum operating conditions: -10°C - 50°C and 0 - 90%RH (non-condensing)

PM₁₀

Sensor: Particle laser / Unit: µg/m³
Range: 0 - 1.000 µg/m³ / Resolution: 1 µg/m³
Accuracy: ±25 µg/m³ (0 -100 µg/m³), ±25% m.v. (101 - 1000 µg/m³)
Lifespan¹: >10 years
Recommended conditions: 10°C - 40°C and 20 - 80%RH
Maximum operating conditions: -10°C - 50°C and 0 - 90%RH (non-condensing)

* The measurements can be displayed in either relative Index Points values (recommended) or in µg/m³ or ppb concentrations.

[1] Lifespan is based on the average lifetime of the sensor, at which the specified accuracy is guaranteed. After the indicated years, it is recommended to replace the sensor to guarantee the accuracy of the measurement.

PM_{4,0}

Sensor: Particle laser / Unit: µg/m³

Range: 0 - 1.000 µg/m³ / Resolution: 1 µg/m³

Accuracy: ±25 µg/m³ (0 -100 µg/m³), ±25% m.v. (101 - 1000 µg/m³)

Lifespan¹: >10 years

Recommended conditions: 10°C - 40°C and 20 - 80%RH

Maximum operating conditions: -10°C - 50°C and 0 - 90%RH (non-condensing)

PM_{1,0}

Sensor: Particle laser / Unit: µg/m³

Range: 0 - 1.000 µg/m³ / Resolution: 1 µg/m³

Accuracy: ± (5 µg/m³ + 5% m.v.) (0 -100 µg/m³), ±10% m.v. (101-1000 µg/m³)

Lifespan: >10 years

Recommended conditions: 10°C - 40°C and 20 - 80%RH

Maximum operating conditions: -10°C - 50°C and 0 - 90%RH (non-condensing)

Formaldehyde

Sensor: Electrochemical / Unit: ppb

Range: 0 - 1000 ppb / Resolution: 1 ppb

Accuracy: ±20 ppb or ±20% m.v., whichever is larger

Lifespan: >6 years

Recommended conditions: 10°C - 30°C and 30 - 70%RH

Maximum operating conditions: 0°C - 50°C and 10 - 95%RH (non-condensing)

O₃*

Sensor: Electrochemical / Unit: ppb

Range: 0 - 5.000 ppb / Resolution: 1 ppb

Accuracy: ±10 ppb (0 - 500 ppb), ±2% m.v. (500 - 5000 ppb)

Lifespan¹: >10 years

Recommended conditions: -20°C - 40°C and 15 - 90%RH

Maximum operating conditions: -30°C - 55°C and 10 - 95%RH

NO₂*

Sensor: Electrochemical / Unit: ppb

Range: 0 - 2500 ppb / Resolution: 1 ppb

Accuracy: ±20 ppb (0 - 500 ppb), ±(3% m.v. & 5 ppb) (500 - 2500 ppb)

Lifespan¹: >10 years

Recommended conditions: -20°C - 40°C and 15 - 90%RH

Maximum operating conditions: -30°C - 55°C and 10 - 95%RH

CO*

Sensor: Electrochemical / Unit: ppm

Range: 0 - 1000 ppm / Resolution: 0,1 ppm

Accuracy: ±1 ppm (0 - 100 ppm), ±1% m.v. (100 - 1000 ppm)

Lifespan¹: >10 years

Recommended conditions: -20°C - 40°C and 15 - 90%RH

Maximum operating conditions: -30°C - 55°C and 10 - 95%RH

Noise

Sensor: MEMS Microphone / Unit: dB

Range: 30 - 120 dB / Resolution: 1 dB

Accuracy: ± 5 dB

Recommended conditions: 0°C - 45°C

Maximum operating conditions: -40°C - 100°C

[1] Lifespan is based on the average lifetime of the sensor, at which the specified accuracy is guaranteed. After the indicated years, it is recommended to replace the sensor to guarantee the accuracy of the measurement.

* Due to the cross-sensitivity of electrochemical sensors (CO, NO₂, and O₃) to multiple factors, they may register peaks that do not correspond to the target gas. Electrochemical sensors require a [preheating](#) period.

4. Indicators



MICA LED Indicator

MICA devices feature an LED ring indicator located on the front of the device that indicates the actions to take based on the ventilation needs of the space.

The LED changes color (red, yellow and green) according to the levels of a specific parameter or indicator defined by the user. The default indicator (recommended by inBiot) is the Ventilation Efficacy Indicator, which is based on continuous monitoring of CO₂ and TVOC, and is represented on a scale from 0 to 100.

The Indoor Air Quality (IAQ) Indicator is based on the RESET AIR INDEX and allows for simple It is



No need to ventilate



It is recommended to ventilate



Ventilation is needed

My inBiot Indicators

Indoor Air Quality



Based on the RESET AIR INDEX, it shows the indoor air quality status of a space on a scale of 0 to 100. It enables real-time and straightforward checking of the overall air quality in a specific area. The IAQ indicator also includes improvement recommendations and allows for tracking the evolution of air quality over the selected period.

It is calculated from continuous monitoring data of the most relevant parameters for defining indoor air quality, such as CO₂, TVOC, and PM2.5, and their combined impact.

It takes into account the cumulative effect of exposure over time, evaluating the sum of concentrations of different pollutants and considering the objectives of the RESET AIR Standard, as well as the know-how developed by inBiot regarding the behaviour of specific CO₂, TVOC, and PM2.5 sensors in a monitoring device, and the impact on health of different parameters combined under certain conditions of indoor space use.

The indicator defines 6 impact categories on indoor air quality: poor (0-16%), inadequate (17-32%), fair (33-48%), moderate (49-65%), good (66-83%), and excellent (84-100%), according to the calculation made by an algorithm based on CO₂, TVOC, and PM2.5 concentrations.

1. Poor: Continuously low levels of indoor air quality can endanger the health and well-being of occupants.
2. Inadequate: Prolonged inadequate indoor air quality is a health and well-being alarm situation.
3. Fair: Indoor air quality with a low trend implies the possibility of experiencing adverse health effects.
4. Moderate: Indoor air quality is moderate, and although the general public is unlikely to be affected in this range of the indicator, hypersensitive individuals may experience mild to moderate conditions.
5. Good: Air quality is good, although levels of pollutants may be detected, decreasing the desired indoor air quality and potentially causing specific long-term problems.
6. Excellent: Indoor air quality is excellent, and there is no risk to health.

The Ventilation Efficiency Indicator measures in real-time the effectiveness of ventilation in an indoor space, represented on a scale of 0-100 and based on continuous monitoring of CO₂ and TVOC.

Ventilation Efficiency

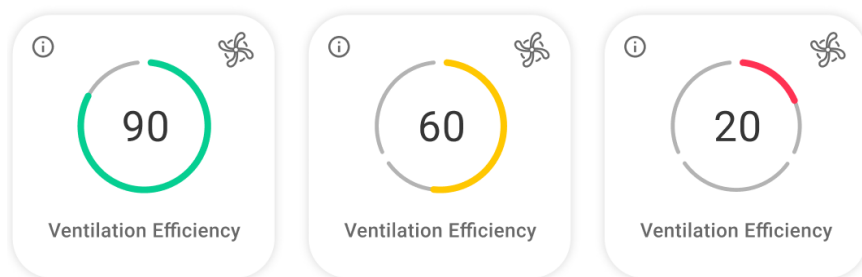

The “Ventilation Efficiency Indicator” in indoor spaces is a tool developed by inBiot to evaluate and control the effectiveness of ventilation and the degree of air renewal. CO₂ and TVOC are two important parameters to determine if ventilation is adequate and sufficient to maintain a healthy and comfortable indoor environment.

Continuous monitoring of CO₂: Carbon dioxide is a gas exhaled in breathing and, therefore, a good indicator of the degree of air renewal in an occupied space. Elevated CO₂ levels can be an indication of inadequate ventilation.

Continuous monitoring of TVOC: Total volatile organic compounds (TVOC) are the set of chemical substances released into indoor air from products and building materials, equipment, or cleaning products, such as paints, furniture, or hygiene products. Exposure to high levels of TVOC can cause discomfort and health problems.

The Ventilation Efficiency Indicator based on continuous monitoring of CO₂ and TVOC allows for evaluating indoor air quality in real-time and provides valuable information on whether the ventilation degree of the space is sufficient to maintain a healthy indoor environment. When CO₂ and TVOC levels exceed certain limits established by regulations or standards, the indicator is negatively affected. This indicator is calculated through an algorithm developed by inBiot, through which the person responsible for the air quality of the space is pro-actively informed so that corrective measures can be taken, such as adjusting, regulating, and controlling the space’s air renewal systems.

The indicator defines 6 impact categories on ventilation effectiveness: poor (0-16%), inadequate (17-32%), fair (33-48%), moderate (49-65%), good (66-83%), and excellent (84-100%), according to the calculation made by the algorithm based on the concentration of CO₂ and TVOC.

The transmission of viruses in indoor spaces is so complex and diverse that it can significantly change depending on the type of virus. There are several key parameters relevant in indoor spaces, such as temperature, relative humidity, ventilation effectiveness calculated from CO₂ concentration, or suspended particles present in indoor air.

Resistance to Virus Spread

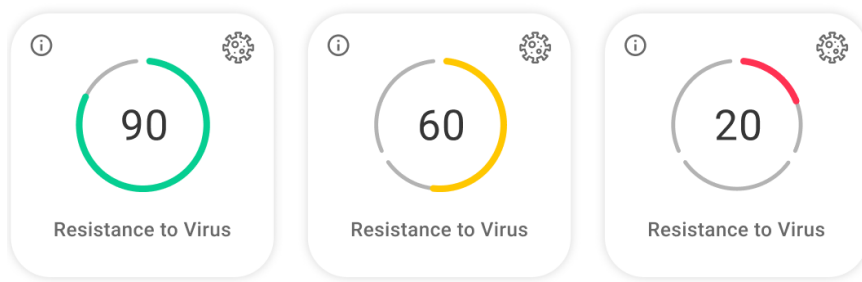

The new Resistance to Virus Spread Indicator from My inBiot indicates the probability of airborne virus propagation in an indoor space. Based on the RESET VIRAL INDEX, it shows on a scale of 0-100 the resistance that the air in a space offers to virus propagation. The indicator calculates the infection potential based on scientifically validated indoor air quality metrics, such as temperature, relative humidity, PM2.5 concentration, and CO₂, evaluated through inBiot monitoring technology.

Although it is currently impossible to measure airborne virus transmission in real-time, continuous monitoring of a building's capacity to minimize the potential for airborne transmission infection is possible through a series of parameters. To do this, it is necessary to combine scientific research with real-time results in a standardized and meaningful way. This has shown the direct impact of humidity, temperature, and suspended particles in the air on the rate of viral infections.

Therefore, to understand the infection risk, it is necessary to know the virus's survival, the impact of different indoor air quality parameters on the immune system, and the dose of such exposure:

$$[\text{Virus Survival}] + [\text{Immune System Impact}] + [\text{Dose}] = [\text{Infection Risk}]$$

From this information, the resulting algorithm from the research work conducted by RESET for obtaining the virus indicator is applied, calculated in real-time in My inBiot from MICA monitoring data:

- VS: Virus Survival
- ISPM: Impact of PM2.5 on the immune system
- ISRH: Impact of relative humidity on the immune system
- PVDr: Potential Viral Dose Risk
- AIP: Airborne Infection Potential
- RVI: RESET Virus Indicator

Impact of different virus indicator parameters:

Temperature

The virus infection rate is significantly reduced at room temperature (20°C) compared to colder temperatures, where viruses have greater persistence. On the other hand, at high temperatures, viruses destabilize and generally reduce their contagion capacity. High temperatures can reduce virus activity, and in some cases, can even inactivate it. Additionally, at low temperatures, the efficiency of our innate respiratory defences is reduced.

Relative Humidity

A relative humidity between 40% and 60% is ideal from the thermohygrometric comfort standpoint, although in terms of virus inactivation, 50% is the optimal level as viruses show less activity. With significantly low relative humidity (below 40%), the mucous membranes of the respiratory tract dry out, reducing their protective capacity against the entry of pathogens into the body. With high relative humidity (above 60%), the proportion of pathogenic germs in the air increases, and there is a higher probability of mold proliferation.

CO₂

Ventilation is the key strategy to reduce the concentration of contaminants in indoor air, whether

chemical compounds or biological agents such as viruses. High CO₂ levels indicate a space with deficient ventilation and, therefore, a higher risk of virus concentration in the air.

PM2.5

Virus transmission and virulence also depend on the size and concentration of inhaled aerosols. With typical breathing, aerosols can continuously deposit in the respiratory system. And in particular, small aerosols (those smaller than 2.5 µm) penetrate deeply into the respiratory tract and have the ability to remain suspended longer than larger particles (PM10), which deposit on surfaces more easily due to gravity.

Thermohygrometric Comfort

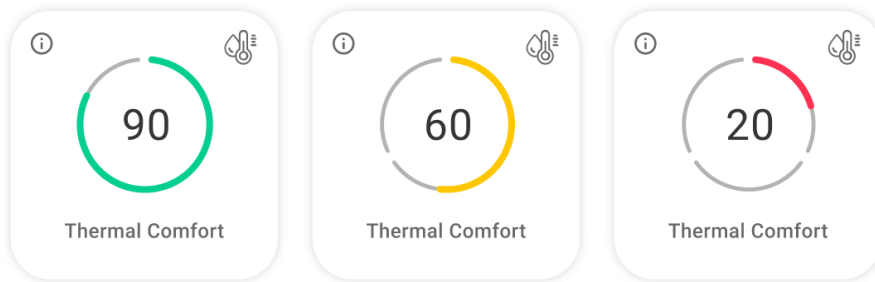

Allows for the easy identification of the temperature and relative humidity range that represents thermal well-being. It helps to objectify the temperature and humidity conditions of an indoor space.

Thermohygrometric comfort can be defined as “the mood state that expresses satisfaction with the thermal environment and is assessed through subjective evaluation”. It greatly influences our experiences in the places where we live and work and is one of the factors that most impact people’s overall satisfaction in buildings since it affects individual levels of motivation, alertness, concentration, and mood. Its influence on the integumentary, endocrine, and respiratory systems also makes thermohygrometric comfort play an important role in our health, well-being, and productivity.

Beyond individual impact, indoor thermohygrometric comfort also influences the energy consumption of buildings. This is due to the impact of heating and cooling systems necessary to maintain the required comfort conditions, which represent approximately half of a building’s energy consumption.

The calculation of comfort conditions is defined in the UNE-EN ISO 7730. However, it is an analytical and interpretive determination of thermal well-being through the calculation of the PMV and PPD indices and local thermal comfort criteria individually, and does not allow for real-time monitoring.

InBiot offers the “Thermohygrometric Comfort Indicator” as an intelligent tool designed to measure and evaluate the level of thermohygrometric comfort in an indoor space. The aim of this indicator is to provide a quantitative measure of people’s satisfaction in terms of temperature and relative humidity, and its impact on well-being conditions.

The indicator defines 6 impact categories on comfort: poor (0-16%), inadequate (17-32%), fair (33-48%), moderate (49-65%), good (66-83%), excellent (84-100%). These categories are determined by the calculation made by an algorithm, based on the real-time measured indoor temperature and relative humidity.

Resistance to Mold Growth

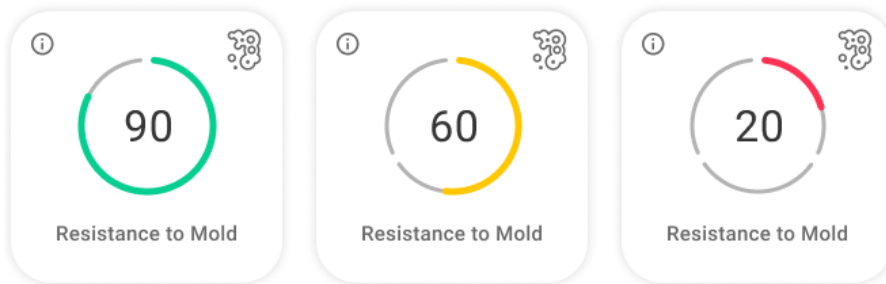

The Mold Growth Resistance Indicator anticipates mold risk by integrating both current conditions and the environmental history of the space. This cumulative approach is essential, as mold does not appear due to a one-off condition, but rather from prolonged exposure to critical humidity.

Mold is a group of microscopic filamentous fungi species, belonging to the Fungi Kingdom, which grow in colonies when environmental conditions; mainly humidity and temperature; are favorable for their proliferation. Mold spores are naturally present in the air and, when deposited on damp surfaces, can begin to grow.

Mold is one of the main microbiological risks in indoor environments. Its presence not only affects the appearance of walls and ceilings, but also compromises occupant health and the durability of building materials. Exposure to mold spores can trigger respiratory, skin, or neurological symptoms, especially in vulnerable individuals such as children, the elderly, and those with asthma or allergies. In this context, having an intelligent indoor mold monitor is key to anticipating and preventing its proliferation.

The indicator classifies the resistance to mold growth into 6 categories: poor (0–16%), inadequate (17–32%), regular (33–48%), moderate (49–65%), good (66–83%) and excellent (84–100%).

5. Levels and Recommendations



Temperature

The comfort temperature range is typically between 21°C and 25°C, according to the RITE (Regulation of Thermal Installations), with 21-23°C recommended in winter and 23-25°C in summer. However, these values may vary based on other factors influencing comfort.

My inBiot Ranges:

MICA establishes an indoor temperature comfort range of 19 to 27 °C only in indoor air quality assessment projects, as it must be analyzed alongside other parameters, such as relative humidity, due to the variability of factors that affect comfort.

Relative Humidity

The ideal relative humidity for a normal indoor temperature ranges between 45% and 50%, with recommended values between 40% and 60%.

My inBiot Ranges:

- 35% - 60%
- 25% - 35% / 60% - 70%
- < 25% or > 70%

Carbon Dioxide (CO₂)

In outdoor environments, the concentration level of CO₂ is approximately 350 - 400 ppm (parts per million). The environment is considered "stale" at values above 800 - 1,000 ppm. Starting at 2,000 ppm, it is considered very stale and symptoms such as headaches, fatigue, and general apathy may occur. More serious effects occur starting at 5,000 ppm, where fainting may happen.

My inBiot Ranges:

- 800 ppm
- 800 - 1,500 ppm
- > 1,500 ppm

Formaldehyde

The limits established in Spain for short-term occupational exposures (VLA-EC) are 0.3 ppm or 370 µg/m³. However, there is no reference value for residential indoor environments.

The technical measurement standard in Bioconstruction SBM2015 provides the following indicative values of formaldehyde concentration in indoor air for rest areas:

- Not significant: <20 µg/m³.
- Weakly significant: 20 - 50 µg/m³.
- Strongly significant: 50 - 100 µg/m³.
- Extremely significant: > 100 µg/m³.

The ranges of values used in the MICA device as indicators are collected taking into account the SBM values for rest areas, as well as the values from which allergic and sensitizing reactions occur.

My inBiot Ranges:

- < 70 µg/m³
- 70 - 120 µg/m³
- > 120 µg/m³

Volatile Organic Compounds (TVOC)

The AGÖEF (German Association for Ecological Research) has been working since 1993 to develop reference values for chemical compounds, both in air and dust samples. The recommended limits are:

- 50th Percentile (normal value): Not considered sufficient evidence for urgent action - TVOC < 360 µg/m³.
- 90th Percentile (attention value): Emission source present - TVOC < 1,572 µg/m³.
- Guidance values: Reference value equivalent to values derived from toxicological risk - TVOC = 1,000 µg/m³.

The indicative values collected in the SBM2015 measurement standard refer to total volatile organic compounds, recommended as precautionary values for rest areas:

- Not significant: <1µg/m³.
- Weakly significant: 100 - 300µg/m³.
- Strongly significant: 300 - 1000 µg/m³.
- Extremely significant: >1000µg/m³.

The ranges of values used in the MICA device as indicators are collected taking into account the values of the German Federal Environmental Agency, from which, depending on the exposure time, allergic and sensitizing reactions, hypersensitivities, or diseases of various pathologies can result.

My inBiot Ranges:

- 204 ppb (< 200 Index Points)*
- 204 - 621 ppb (200 - 400 Index Points)*
- > 621 ppb (> 400 Index Points)*

Particulate Matter (PM1.0, PM2.5 & PM4.0)

PM2.5 particles (with a diameter ≤ 2.5 µm) can remain suspended in the air for weeks and are likely to spread through ventilation systems. The EPA (Environmental Protection Agency of the U.S.) recommends a maximum of 35 µg/m³ for PM2.5, with annual averages limited to 12–15 µg/m³. The EU sets a maximum of 20 µg/m³, with plans to tighten this limit further.

My inBiot Ranges:

- < 12 µg/m³.
- 12- 35 µg/m³.
- > 35 µg/m³.

Particulate Matter (PM10)

Particles larger than 10 µm quickly settle in dust; PM10 particles (with a diameter ≤ 10 µm) can remain suspended for hours.

My inBiot Ranges:

- < 50 µg/m³.
- 50 - 100 µg/m³.
- > 100 µg/m³.

Ozone (O₃)

The importance of ozone as an air pollutant has been recognized since the mid-20th century. The WHO sets a daily maximum exposure limit of 50 ppb based on an 8-hour workday. European and Spanish directives refer only to outdoor air quality and set an exposure limit of 60 ppb for an 8-hour average as well. The daily environmental exposure limit (VLA-ED) establishes these thresholds, which depend on the type of work done during a 40-hour work-week: 50 ppb for heavy work, 80 ppb for moderate work, and 100 ppb for light work.

The ranges used as indicators are based on values recommended by the WHO and European

*The measurements can be displayed in either relative Index Points values (recommended) or in µg/m³ or ppb concentrations.

organizations, as well as levels at which adverse health effects occur.

My inBiot Ranges:

- < 51 ppb.
- 51 - 122 ppb.
- > 122 ppb.

Nitrogen Dioxide (NO₂)

The limits established in Spain for short-term exposures (VLA-EC), referring to 15-minute average periods, are 5 ppm. The daily exposure limits (VLA-ED) for a standard 8-hour workday are 3 ppm. On the other hand, the hourly limit for human health protection is more restrictive and is set at 105 ppb, while the annual limit is 21 ppb. The WHO, on the other hand, sets an annual average exposure limit of 5 ppb and a daily average exposure limit of 13 ppb.

Meanwhile, the EPA sets an annual level of 53 ppb for health protection. All of these are outdoor exposure limits, as there are no regulatory reference values for indoor spaces beyond WHO recommendations or private standards such as WELL certification.

My inBiot Ranges:

- < 21 ppb.
- 21 - 105 ppb
- > 105 ppb.

Carbon Monoxide (O₃)

The WHO sets recommended concentration limits for outdoor spaces. A limit of 25 ppm is set for one-hour exposures and 9 ppm for 8-hour workday exposures. The daily environmental exposure limit (VLA-ED) in Spain sets a maximum of 25 ppm.

The limit for human health protection is also 9 ppm for an 8-hour workday. Regarding indoor exposure limits, LEED certification sets a limit of 9 ppm in an air test prior to the occupancy of a new construction.

My inBiot Ranges:

- < 9 ppm.
- 9 - 25 ppm.
- > 25 ppm.

Noise

Ambient noise is a key parameter for assessing comfort and well-being in indoor environments. Far beyond being a minor nuisance, prolonged exposure to excessive sound can seriously impact health, productivity, and overall quality of life.

With the integration of our smart noise sensor in MICA, buildings can now benefit from real-time, continuous noise detection—enabling preventive action and a data-driven approach to acoustic comfort.

My inBiot Ranges:

- < 45 dB.
- 40 - 80 dB.
- > 80 dB.

6. Installation



To install the MICA on a wall, follow the steps found in the Installation Manual. This manual can be found in our [repository](#).

Before starting the installation, remember to follow these steps:

1. Identify what type of installation you are going to do: on the wall or in an electrical box.
2. Check what communication and connectivity options has your MICA at the bottom of the box.



3. Check that the box contents are correct.
4. Remove the MICA from the box and remove the back cover from the case.



Remove bottom screws (2)



Detach the back cover of the MICA

Note: The recommended height to install the electrical boxes or attach the MICA to the wall is between 120cm and 180cm.

[Download Installation Manual](#)

7. Configuration



Configuring MICA

To configure MICA, you must download the [setup app](#) and follow the steps indicated. If you have questions you can download the Configuration Manual through our [repository](#).

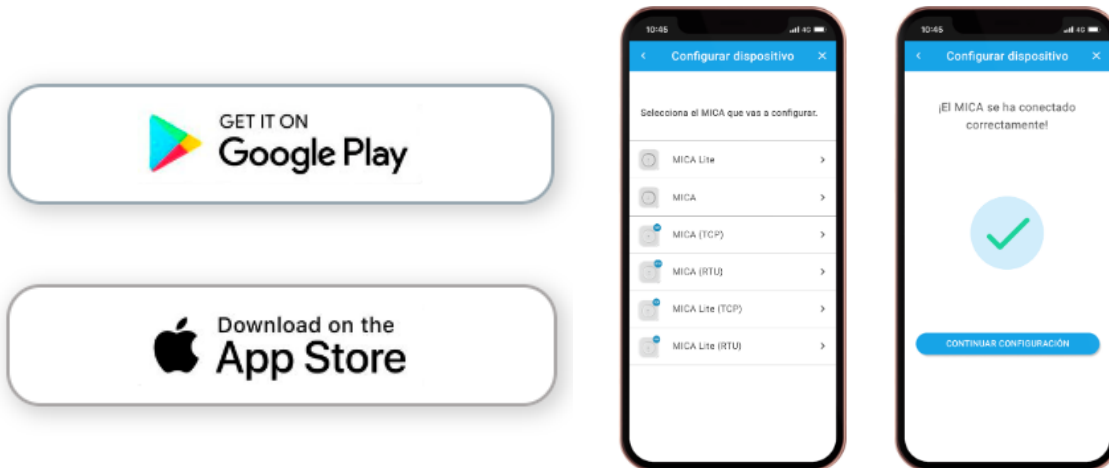

Adding MICA to My inBiot

Once the MICA is configured, it can be added to the My inBiot web platform as follows:

1. First go to myinbiot.com in your browser and log into your account (or create one account if you don't have it yet).

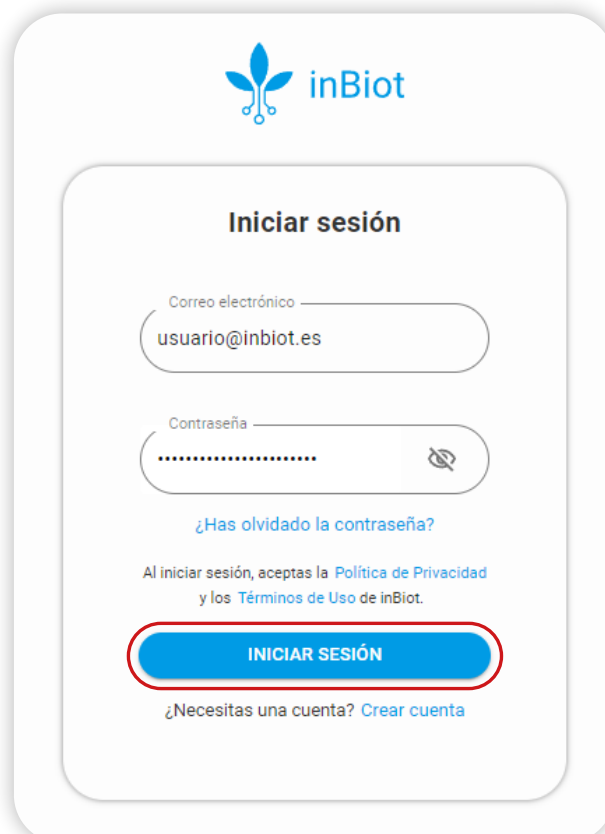

2. Before adding a device to your account, you need to create a project. This can be done the on home page (My Workspace), on the section My Projects.

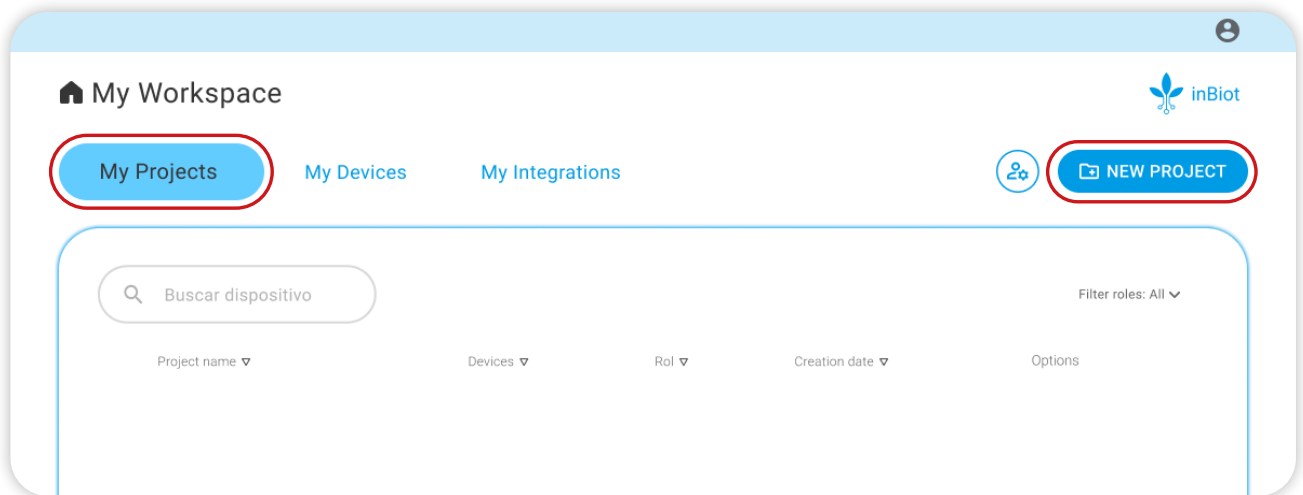

3. Next, to add a device, go to the section My Devices, click on "ADD DEVICE", and fill out the requested device information.

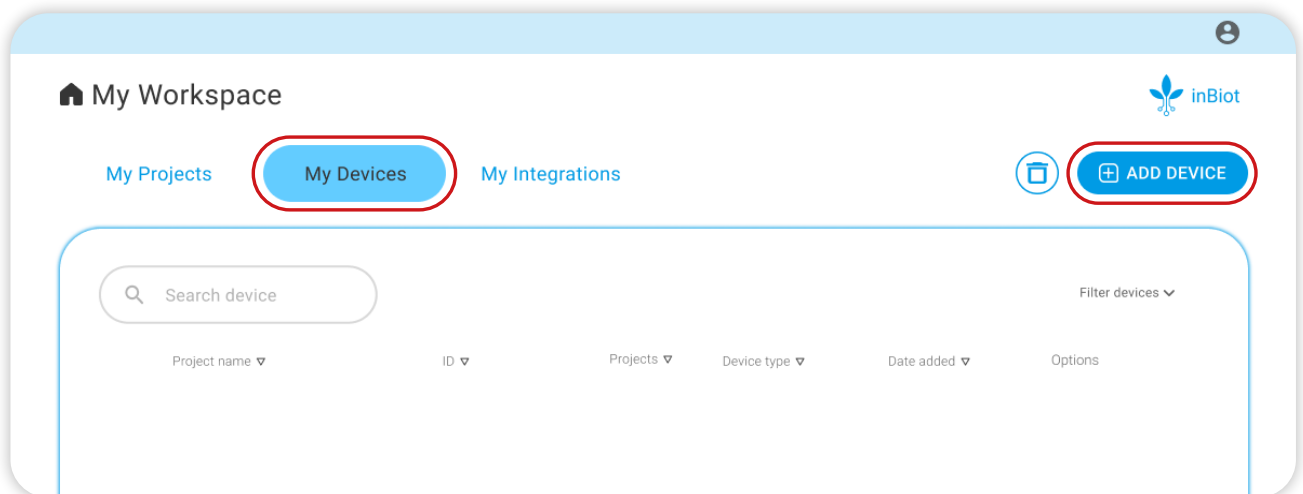

Note: The sensor ID is obtained at the end of the configuration in the inBiot Setup app. You can also check it by pairing your mobile device with MICA and pressing the "INFORMATION & UPDATES" button in the main menu of the setup app.

8. Device operation



Powering MICA

The first time you plug in the device, the white LED ring will light up and start flashing until the following happens:

1. A) If the MICA has been previously configured:
 - If the connection to the Wi-Fi network fails: It goes into Access Point mode for 5 minutes.
 - If the connection to the Wi-Fi network is successful: It flashes green 3 times and then turns white (reading data) until it turns into another color depending on the indoor air quality (green, yellow or red).
- B) If it has never been configured before: It goes into Access Point mode for 5 minutes.
2. If everything went well when the configuration is finished the LED ring will turn white until the device reads the indoor air quality.
3. Once the device reads the indoor air quality, the LED ring will turn to the corresponding color (green, yellow, or red).

Access point

Indicated by the LED ring turning blue, it is used to connect the device to the setup app (via Bluetooth), and it works like this:



- If the connection to the device through the app fails: flashes red 3 times and then returns to the access point.
- If 5 minutes pass and no action is taken: flashes blue 3 times and leaves access point. Then the LED will indicate the connection status and finally display the air quality color (green, yellow, red).
- If the connection to the device through the app is successful: It will stay steady blue until the configuration is finished.

Connection status

To check if the device is connected to the network, press **twice** in succession the touch button located on the MICA logo.



- If connected: The LED ring flashes green 3 times
- If not connected: The LED ring flashes red 3 times.

Note: This light indicates if the device is connected to a network, not to My inBiot platform.

Sending data



- To send data to My inBiot manually, press **once** (shortly) the touch button located on the MICA logo.
- Upon pressing the button, the LED ring will turn white and then return to the previous state.

Remote firmware update.

All devices have the capability to update their firmware remotely, ensuring they are always equipped with the latest improvements and available features. During the update process, the MICA device's LED ring will light up pink to indicate that the process is ongoing. During this period, it is crucial not to disconnect the device from its power source and to wait for it to restart automatically once the update is complete. Additionally, the touch button on the front of the device will be temporarily disabled to prevent any interruption during the process.

Depending on the device model, the process starts in different ways:

1. Most models manage this process automatically, so the user does not need to take any action for their device to update.
2. For the LoRaWAN and SigFox models, there are two options:
 - From the configuration app, in the "Information and Updates" section, you can check the firmware version of the device and see if there is an update available for download. If so, the app will guide you through the update process.
 - If a successful update has been completed previously using the method above, the device will save the Wi-Fi configuration used during that process. This means that, as long as the device is within the range of that network, it will automatically begin the update verification process (the maximum verification time is equal to the configured data upload period).



Taking measurements

The MICA device will record the measured parameters on the web platform at the selected time interval. Depending on the type of account you have, you can select a shorter or longer time interval.

The maximum data upload interval is 60 minutes, regardless of the connectivity type used.

The minimum interval depends on the type of My inBiot account associated with the device and the connectivity technology used (Table 1)

Table 1. Minimum upload interval

Connectivity	Standard Account (min)	Business Account (min)
Wi-Fi	10	1
Ethernet	10	1
LoRaWAN	5	5
NB-IoT/LTE-M	10	10
Sigfox	15	15

There are two options for configuring the data upload frequency:

1. inBiot Setup app: Access "Device Settings" on the main menu.

There, in the "Upload periodicity" section, you can indicate how often (in minutes) the data will be uploaded to My inBiot.

To complete the configuration, select "APPLY CHANGES," and then, remember to select "SAVE AND FINALISE" on the main menu.

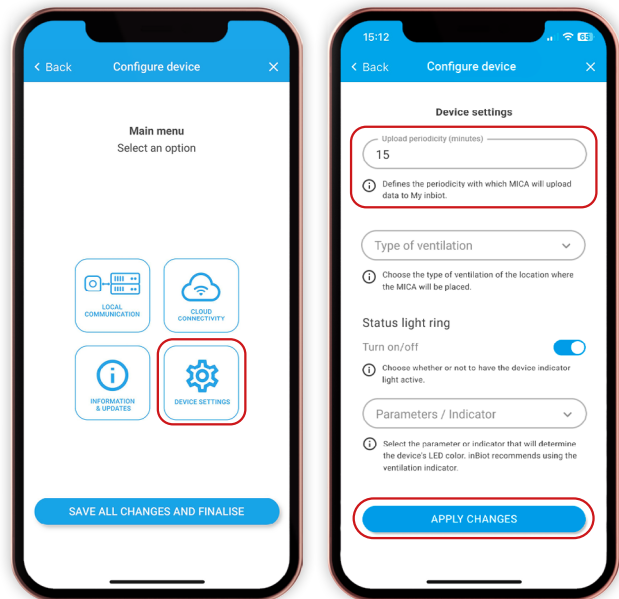

2. My inBiot platform: Access the individual view of the device you want to configure and click on the "OPTIONS" button in the top right corner. There, in the options menu, select the option "Data upload periodicity."

Next, a new window will appear where you can define the time between data uploads and apply this setting to all devices or only to the current one.

To complete the configuration, tap "SAVE CHANGES."

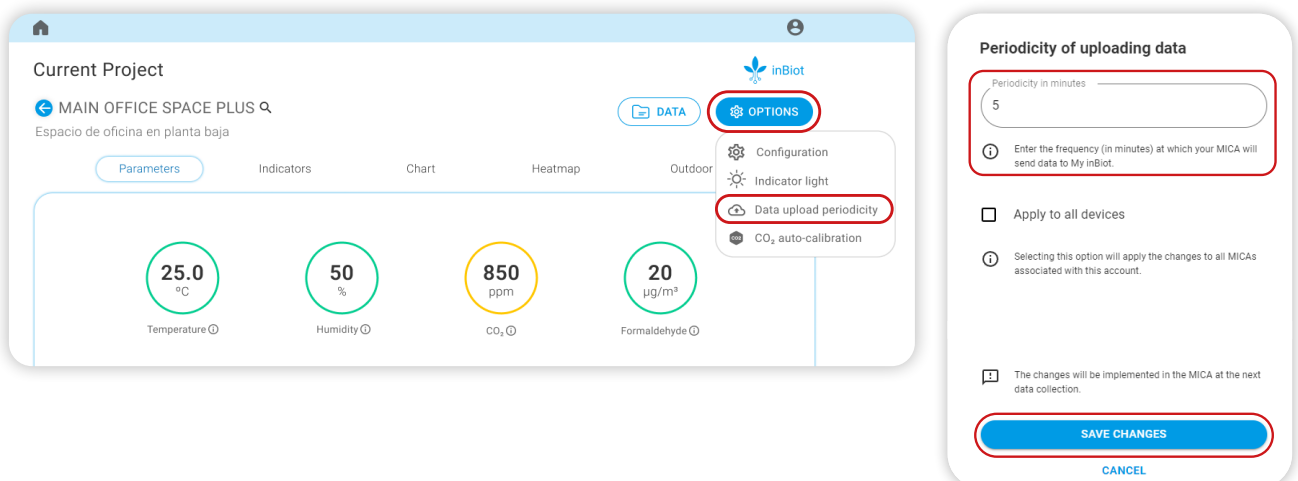

9. My inBiot Platform



You can access My inBiot Web Platform through the following link: www.myinbiot.com/login.

The first time you access the platform, you will need to create an account and password, which you will use to log in each time you access the platform. Within an account, you can have as many devices as you wish.

In the My inBiot web platform you will be able to:

- Consult the parameters in real time.
- View the evolution of the parameters over time: hours, days, and weeks.
- Consult the information on each parameter to know its effects on health, the possible sources of contamination, and recommended ranges.
- Download data for analysis in another application.
- Give access to several clients through a shareable link, which you can also use to display the data on screens for events or offices.

Additionally, My inBiot Business account gives access to more functionalities. This option has an annual subscription fee and it allows you to:

- Configure data collection from 1 minute onwards.
- Download historical data without time limitations.
- Perform multiple downloads of several devices in weekly groups of up to one week.
- Create groups of devices to organize them.
- Create customized alerts when exceeding a certain value previously configured.
- Download statistics, and more.

To learn more about all the features available with a business account, visit our [website](#).

10. Calibration



The calibration process of MICA devices has several phases, from the manufacturer's warranty of the sensors, remote correction of some sensors, and modular design for sensor replacement based on the life span of each specific sensor.

This process allows for:

- Regular maintenance according to the specific requirements of each user.
- The reduction of measurement variations between different devices, both in the short and long term.
- Long-term stability of measurements.

The design of MICA devices includes a curated selection of specific sensors. All sensors are calibrated

Manufacturer's warranty

by the sensor manufacturer itself, with a corresponding warranty.

Additionally, some sensors, such as CO₂ or VOC, have an automatic self-calibration process by software.

The MICA carbon dioxide sensor is an NDIR (non-dispersive infrared) sensor that does not suffer from

Self-calibration of sensors

Carbon dioxide (CO₂)

physical degradation but does require calibration. An automatic baseline calibration (ABC) algorithm is used periodically. The baseline is adjusted to the CO₂ concentration of clean outdoor air once per calibration cycle. For optimal performance, clean outdoor air concentration levels must be reached at least once during each calibration cycle.

Additionally, it's important to note that the first calibration cycle is always around 24 hours, so you should reach clean ambient air concentration levels through proper ventilation during that initial period. The measurements will fluctuate during that time until the first cycle is complete. MICA does not store the baseline adjustment, so this process will repeat in case of power interruptions.

The MICA carbon dioxide sensor is an NDIR (non-dispersive infrared) sensor that does not suffer from physical degradation but does require calibration. An automatic baseline calibration (ABC) algorithm

Volatile Organic Compounds (TVOC)

is used periodically. The baseline is adjusted to the CO₂ concentration of clean outdoor air once per calibration cycle. For optimal performance, clean outdoor air concentration levels must be reached at least once during each calibration cycle.

Additionally, it's important to note that the first calibration cycle is always around 24 hours, so you should reach clean ambient air concentration levels through proper ventilation during that initial period. The measurements will fluctuate during that time until the first cycle is complete. MICA does not store the baseline adjustment, so this process will repeat in case of power interruptions.

11. Safety instructions



Cleaning and storage

- To clean the device, you should use a damp cloth and mild detergent. Do not use solvents or abrasives.
- The device is intended for indoor use only and is not suitable for outdoor use.
- Store it in an area with moderate temperature and humidity: -5 °C to 50 °C (23 °F to 122 °F) and less than 90% relative humidity.
- Do not put the device in water.

Important safety notes

- The MICA device is developed for general-purpose air quality monitoring only and has not been certified for use in accordance with local or state carbon monoxide monitoring or alarm requirements.
- The MICA device has not been tested by an independent laboratory for compliance with UL 2034 or IAS 6-96. CO15-en-EN_v1.0 7/17 3.
- It is the customer's responsibility to obtain and apply current local, state, and national regulations regarding CO alarms, monitoring, and testing.

Indications - Warranty

The device includes a 3-year warranty for products sold in Spain, 2 years for products sold within the EU/UK, and 1 year for those sold in the US/Canada and other countries.

If you find any defect in the device that is the responsibility of inBiot and not due to misuse after purchasing the device, contact our Customer Service team through the support web form and provide the device ID, proof of purchase, date of purchase, and description of the issue. We will contact you as soon as possible to proceed with the repair or replacement of the device.

For devices that are outside the warranty period, you may request a repair or replacement in accordance with inBiot's repair rates. Contact our Customer Service team for more information.

The right to warranty will be revoked in case of:

- Damage caused by failure to comply with the inBiot Usage or Installation Manual.
- The device has been modified by the customer or unauthorized third parties.
- The device has been involved in an accident or misused.
- The device was damaged during installation.
- The device was damaged by the system in which the product is used.
- The device has sustained damage caused by liquids.
- The device was damaged during transport to our facilities.
- The device has damage on the interface or charging connections.
- The device has been counterfeited: The warranty only applies to products with the inBiot brand, serial number, and logo identifying it as such. The warranty does not apply to any product that was not manufactured by or with permission from inBiot.

In the European Union, electronic equipment may not end up in household waste: it must be disposed of properly in accordance with Directive 2002/96/EC OF THE EUROPEAN PARLIAMENT

End of life

AND THE COUNCIL of 27 January 2003 on waste electrical and electronic equipment (WEEE). At the end of its useful life, please dispose of this device in accordance with the legal regulations in force.

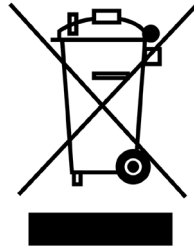



inBiot

Sense your building

www.inbiot.es
support@inbiot.es
Copyright © inBiot Monitoring SL