

MODULAR FORMWORK FOR ROUND AND OVAL COLUMNS

# geotub

reusable system in ABS



- REUSABLE
- LIGHT
- MODULAR



Supplied by



*Making your job easier!*

09 42 68 101  
sales@everitts.co.nz  
www.everitts.co.nz



# GEOTUB VISION

*CONSTRUCTION and RESPECT: This is the vision which characterizes the work of Geoplast. To build buildings respecting the environment. Beginning from the choice of the raw materials. Our plastic formwork perfectly embodies this principle.*

## THE ANNUAL WORLD CONSUMPTION OF WOOD IS EQUAL TO 1,5 BILLION M<sup>3</sup>, OF WHICH 55% IS USED IN CONSTRUCTION

After having exhausted the resources of timber in Southeast Asia and Central Africa, logging is causing the deforestation of the Amazon Rainforest, which is considered the green lungs of our Planet.

In the last three decades 55 million hectares of rainforest have been cleared, an area corresponding to the territory of France.

This is why we decided to make our contribution creating a line of formwork in plastics, a recyclable material that is the only sustainable alternative to wood and cardboard.

We have made them with special attention to their weight to reduce the amount of energy required for their handling: this is yet another form of respect.

Geoplast S.p.A. in Green Building Council Italia,  
The Network of Green Building.





GEOTUB

# THE FIRST FORMWORK IN ABS

**GEOTUB** is the first formwork in technopolymer for the construction of round and oval columns; it is a complete system for the production of columns, both for residential and industrial use.

Extremely light and modular, **GEOTUB** is a new idea of reusable formwork, easy to store and cleanable just with water.



## Why ABS

(Acrylonitrile Butadiene Styrene)

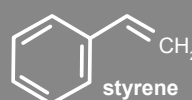
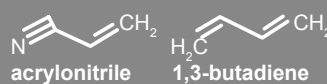

High mechanical strength

Shock resistance

Thermal stability  
(-30°C / +70°C; -22°F / +158°F)

Very high surface quality

Recyclable material

# GEOTUB ADVANTAGES

The only light, reusable and modular system for the production of round and oval columns

## light



Weighting max 10 kg, **GEOTUB** can be handled quickly on site without having to use cranes or other mechanical lifting devices

## fast



Light and easy to assemble, it can be installed and handled by a single person

## modular



All elements are 600 mm long and only the elements necessary for the pour are used

## reusable



**GEOTUB** is cost effective as it can be reused **more than 100 times** when properly used and maintained

## dismantling



Concrete does not stick to plastic: dismantling is extremely easy, the forms can be cleansed using just a little water, avoiding any need of detergents

## storage



**GEOTUB** can be safely and conveniently stored even in damp places

# GEOTUB THE MODULAR FORMWORK

Up to 80 kN/m<sup>2</sup> fresh concrete pressure

**REUSABLE**

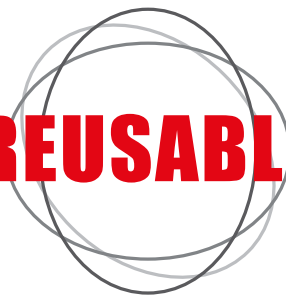

max  
10Kg



## GEOTUB MATERIAL

Acrylonitrile Butadiene Styrene	ABS
Coefficient of thermal expansion	0,05 mm/m/°C

## SIZE

Minimum diameter	250 mm
Maximum diameter	1000 mm
Height	600 mm (actual size 605 mm)

## The handle

The standard fixing item for all Geoplast Formwork

Light and intuitive

Firmly locks with a simple 90 degree turn

Strength (guaranteed by specially engineered materials)

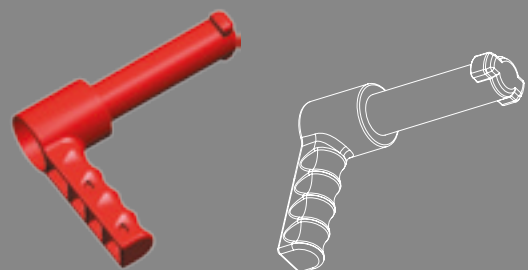

HANDLE MATERIAL: POLYAMIDE - COEFFICIENT OF THERMAL EXPANSION 7-10 (1/K 10<sup>-5</sup>)

Items and accessories

# DIMENSIONAL TABLES



**GEOTUB  
Ø25**

ø250 H605

ABS

2.96

810 x 1210 x H2200

60

6



**GEOTUB  
Ø30**

ø300 H605

ABS

3.69

930 x 1210 x H2450

60

6



**GEOTUB  
Ø35**

ø350 H605

ABS

4.28

1030 x 1210 x H2260

50

7

actual size (mm)

material

weight (kg)

package size (mm)

No. pieces per pallet

No. handles



**GEOTUB  
Ø40**

ø400 H605

ABS

4.78

1140 x 1210 x H1900

40

7



**GEOTUB  
Ø45**

ø450 H605

ABS

5.22

1210 x 1230 x H2330

48

8



**GEOTUB  
Ø50**

ø500 H605

ABS

5.60

770 x 1210 x H2100

20

8

actual size (mm)

material

weight (kg)

package size (mm)

No. pieces per pallet

No. handles



**GEOTUB  
Ø60**

ø600 H605

ABS

6.48

770 x 1210 x H2350

20

9



**GEOTUB  
Ø70**

ø700 H605

ABS

8.21

870 x 1210 x H2380

18

10



**GEOTUB  
Ø80**

ø800 H605

ABS

8.97

970 x 1210 x H2350

16

10

actual size (mm)

material

weight (kg)

package size (mm)

No. pieces per pallet

No. handles

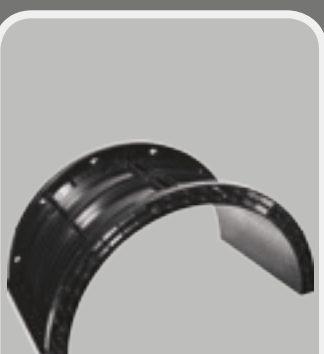

**GEOTUB  
Ø90**

ø900 H605

ABS

9.80

1070 x 1210 x H2530

16

11

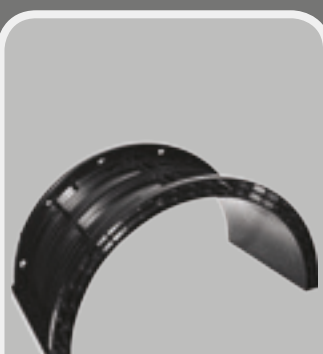

**GEOTUB  
Ø100**

ø1000 H605

ABS

10.70

1170 x 1210 x H2400

14

11



**HANDLE**

NYLON

0.1

200 pcs. (bag)

5000

actual size (mm)

material

weight (kg)

package size (mm)

No. pieces per pallet

No. handles

No. pieces per pallet

No. handles

# GEO TUB INSTALLATION GUIDE

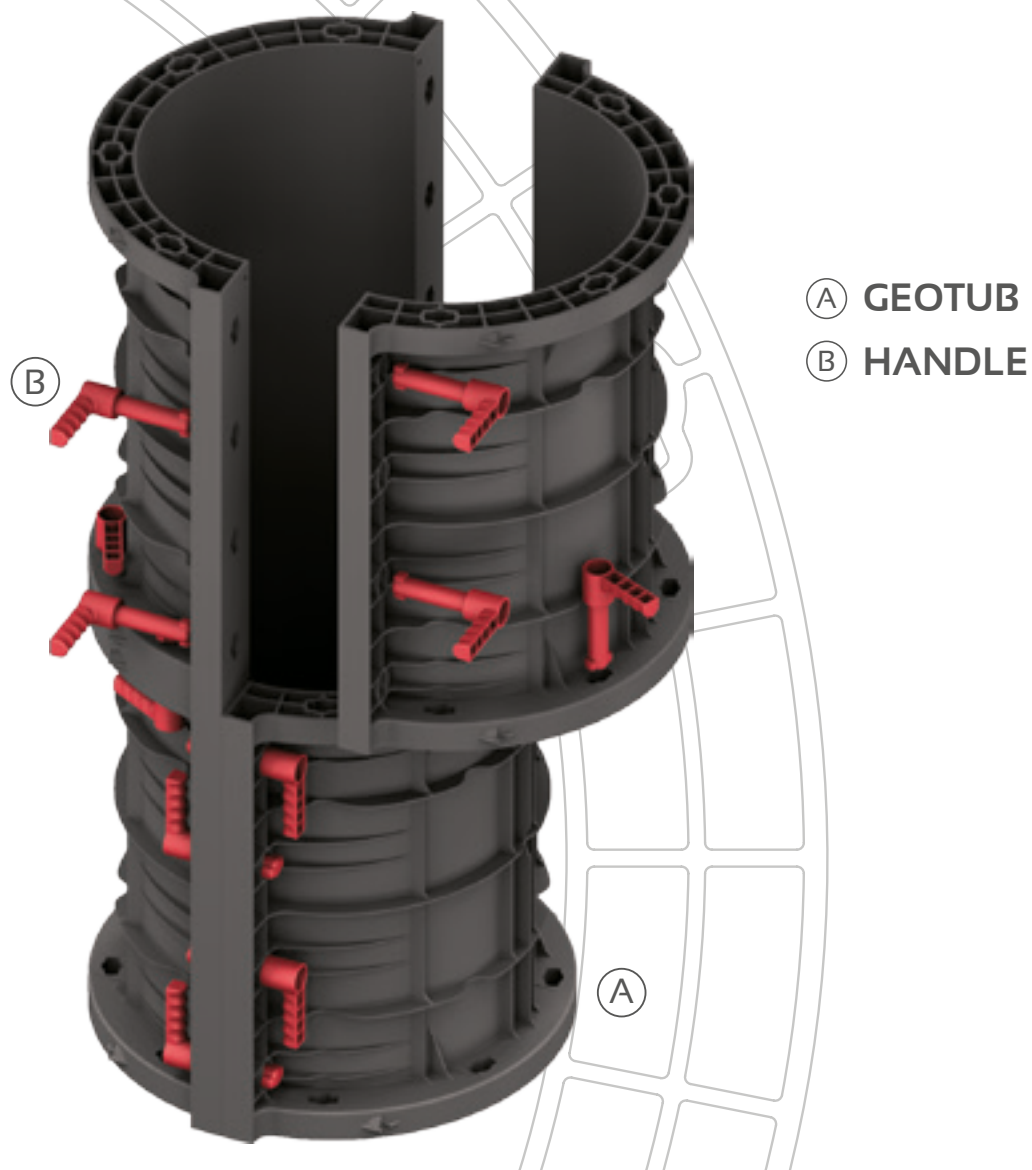

## Handle locking

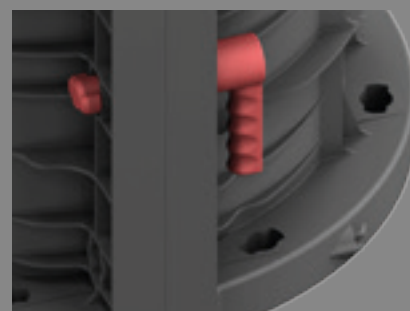
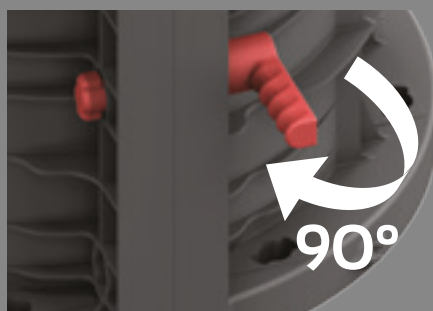
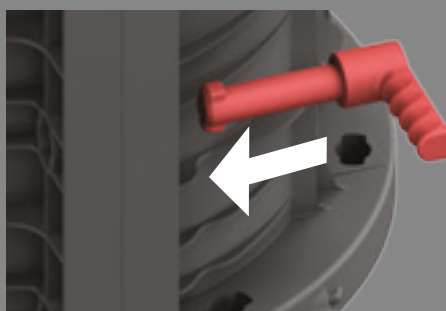

# GEOTUB POUR HEIGHTS

## GEOTUB configuration of a column

	○ ø Nominal diameter (mm)	○ Length of single form (mm)	○ Forms per column of 3 mt (pcs.)	○ No. handles per column of 3 mt (pcs.)	○ Column Length (mm)
ø25	250	605	10	60	300
ø30	300	605	10	60	300
ø35	350	605	10	70	300
ø40	400	605	10	70	300
ø45	450	605	10	80	300
ø50	500	605	10	80	300
ø60	600	605	10	90	300
ø70	700	605	10	100	300
ø80	800	605	10	100	300
ø90	900	605	10	110	300
ø100	1000	605	10	110	300

## Max. pour height (single pour)

ø25 - 40	ø45 - 60	ø70 - 100
6000 mm	4800 mm	3600 mm

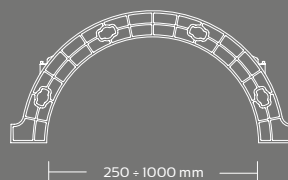
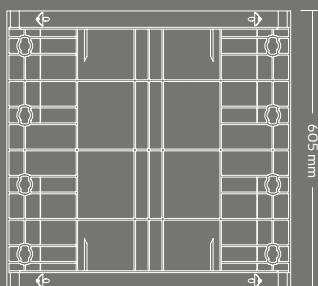
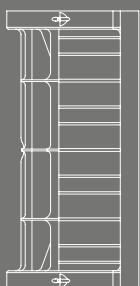

# REUSABLE COLUMNS



## All-round advantages

**GEOTUB** is the first reusable plastic formwork for the construction of round columns. It allows a fast and easy dismantling without using releasing agents. The panels are very light:

they can be handled and installed by a single person. Properly assembled and dismantled, and cleaned just with water, the product can be reused more than 100 times.

Reusable  
Easier handling  
Smooth surface

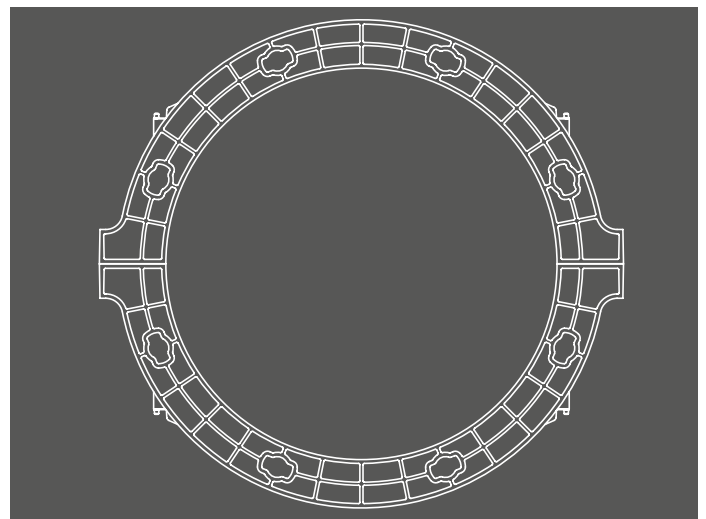



# MARINE SOLUTIONS



## Water resistant

As for all Geoplast formwork, **GEOTUB** is particularly suited to build columns when working in presence of water, which can make the work difficult and complicated. In this case the use of **GEOTUB** is the only possible solution, since it is made of ABS: in fact this material, compared

to cardboard and steel, does not suffer from degradation due to natural weathering. Moreover, thanks to its lightness and modularity, the work of the laborers is much easier even in difficult situations such as those mentioned above.

**Easy to handle**  
**Does not suffer weathering**  
**Reusable 100 times**

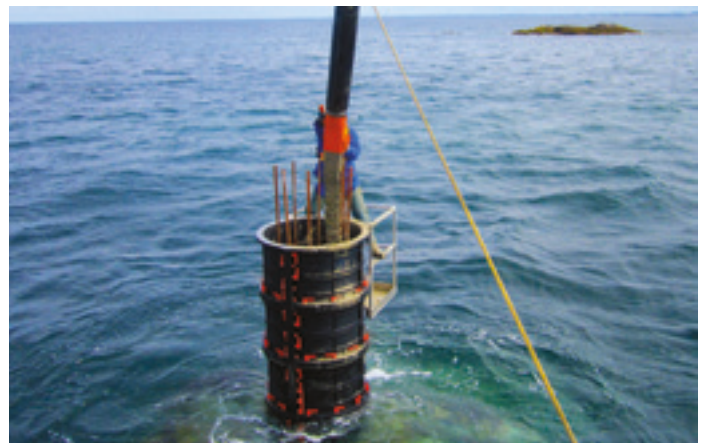



# SEISMIC HAZARD ADJUSTMENT

## Extension of cross section

The size of the columns should be adjusted, extending their cross section, to prevent the hazard of earthquakes. **GEOTUB** modular formwork are easy to handle manually and they allow to work even in narrow spaces,

where steel formwork, too heavy and non-dismantlable, can not be used. Moreover, the handles allow a lateral installation, thus avoiding to insert the formwork from the top, as with cardboard ones.

**Easy to assemble**

**Light panels**

**Easy to handle**

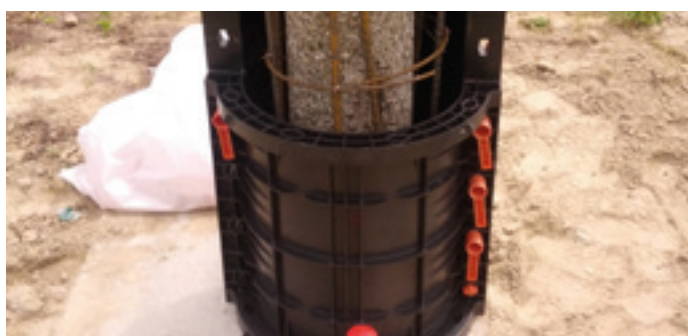

# RENOVATION OF DETERIORATED COLUMNS

## Protection of exposed reinforcement

In the case of deteriorated concrete and exposed rebar it is necessary to repair the columns restoring an adequate concrete cover. **GEOTUB** formwork system is ideally suited for this kind of repair job as it is installed

around the existing columns (unlike cardboard tubes which are hindered by the presence of any structure above the columns). Its lightweight makes it much easier to use than heavy metal forms.

Quick to assemble  
Simple to manage  
Reusable 100 times



# OV AL C O L U M N S



GEOTUB  $\varnothing$ 25/30/35/40/45/50/60 & GEOPANEL

## The ideal solution for car parks

Most of the **GEOPLAST** formwork panels share the same module, so different systems are compatible with one another. **GEOPANEL** and the **GEOTUB** circular column formwork work together very efficiently to produce el-

liptic columns. This is a very useful tool for the production of elliptic columns in multi-storey car-parks, much appreciated for their slender looks and the better maneuvering space given to vehicles.

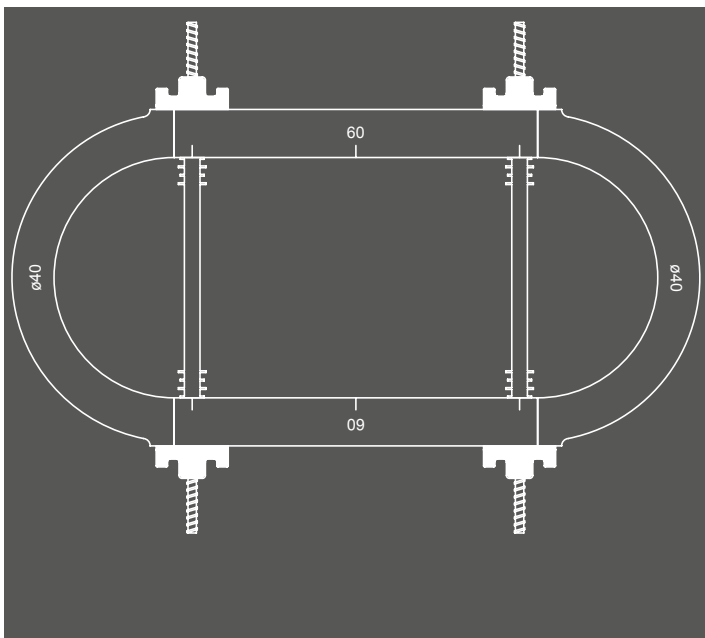

# PRECAST COLUMNS



## Serial production of columns

**GEOTUB** system is highly competitive not just for the construction of in-situ poured columns, but also for the creation of precast columns which can be assembled later. ABS

formwork are ideal for the mass production of serial columns as it is very strong and it produce a very smooth concrete finish. Additionally it can be reused over than 100 times.

**Extreme strength**  
**Easy to handle inside**  
**industrial buildings**  
**No dismantling agent**  
**required**



# ELECTRICAL GRID PYLONS FOUNDATIONS

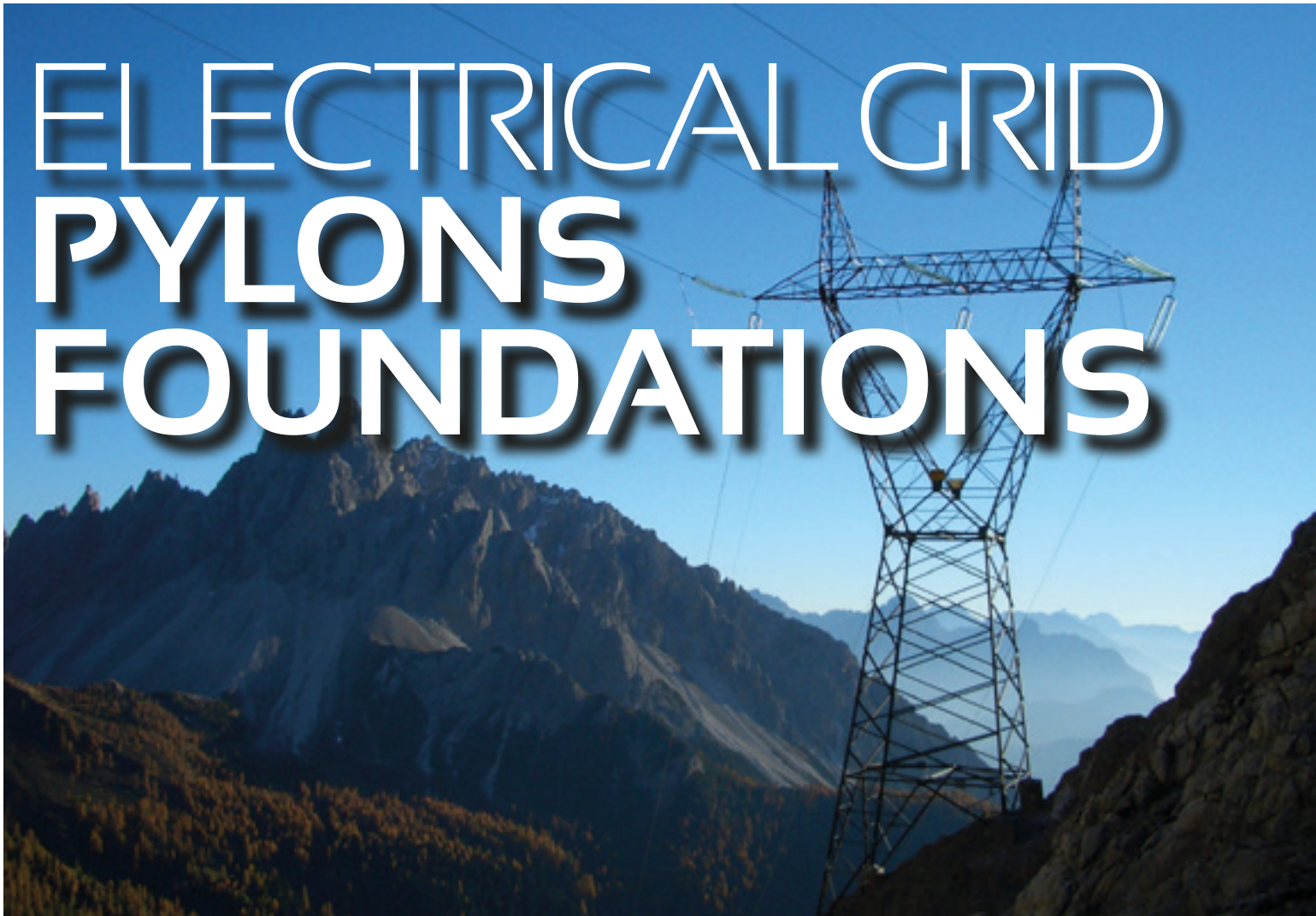

## Foundations for electricity pylons

**GEOTUB** is particularly suited for the construction of new foundations for electricity pylons: this kind of construction site consists of relatively small jobs, often in remote or scarcely accessible locations. The low weight and ease of use make it very simple to han-

dle and transport the **GEOTUB** forms, reducing the production cycle time and improving safety. **GEOTUB** elements are easily assembled around existing foundations, greatly simplifying rebuilding or reinforcing jobs.

- Low weight
- Modular
- Reusable 100 times



# GEOTUB TECHNICAL GUIDELINES

## A) SHORING

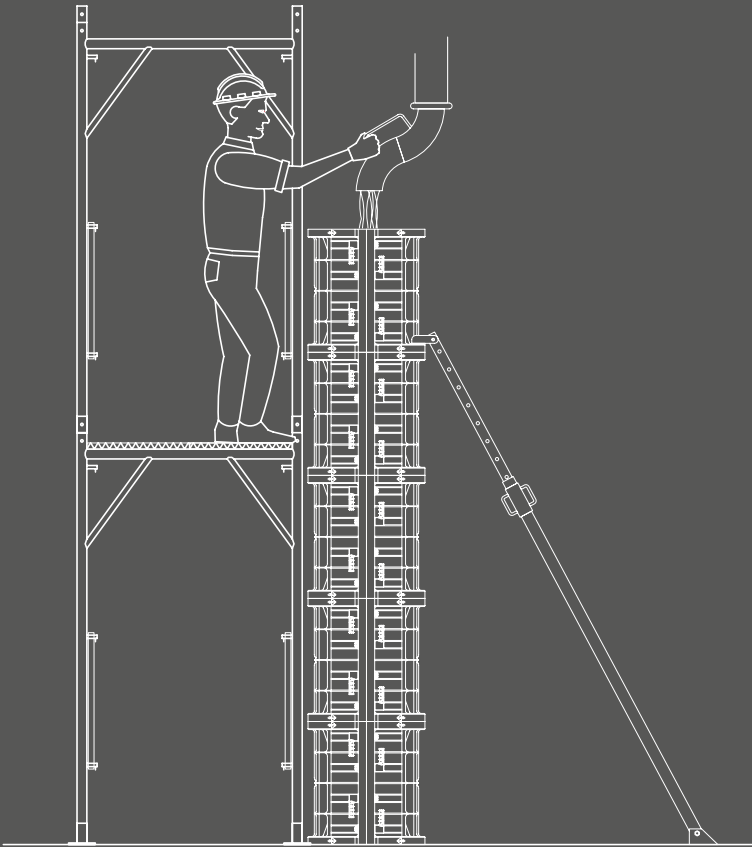

The shoring is performed using a steel bracket to connect push-pull props to the formwork. The brackets are available in various sizes to suit any commercially available props.

## B) GROUND ANCHORING

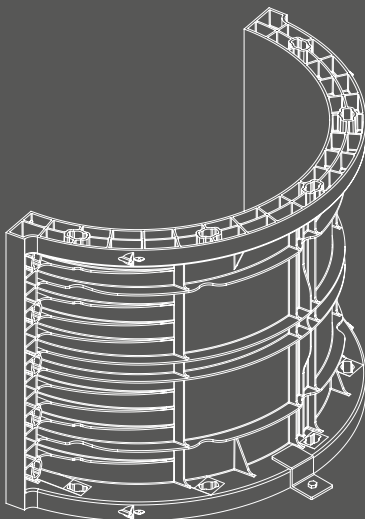

Anchoring to the ground to avoid lifting of the formwork is done using metal brackets or otherwise with timber.

# OPERATION AND MAINTENANCE REQUIREMENTS

## POUR

Only immersion concrete vibrators are allowed. ABS formworks are not fireproof, so do not place them close to hot objects or open flame.

## HANDLING

Use the Geoplast lifting hook to move the assembled elements with a crane. Before lifting make sure that the lifting cables have an uniform draft.

## PANEL CLEANSING

After every use, cleanse the panels with water (preferably with a pressure washer). Any deposit of concrete should be removed with a spatula or a wire brush.

## RELEASING AGENT

As long as the contact surface of the panels shows no signs of wear, no releasing agent is required.

## STORAGE

In order to facilitate the handling and lifting of the panels and all accessories, store them on pallets or battens to keep them off the ground. Although the product does not suffer weathering, it is preferable to store the panels in a dry place away from direct sunlight.

# RATE OF RISE DIAGRAM

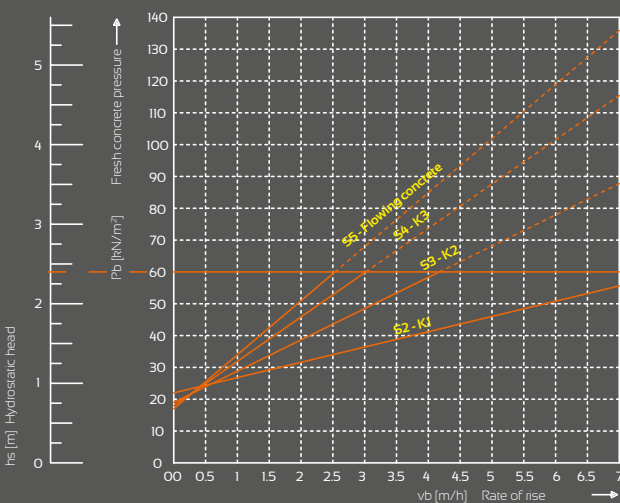

CONSISTENCY CLASS	UNI EN 206:2006		DIN 18218	
	CLASSIFICATION	SLUMP	CLASSIFICATION	SPREADING
Wet	S1	10 ÷ 40 mm		
Stiff	S2	50 ÷ 90 mm	F1 (K1)	≤ 34 cm
Plastic	S3	100 ÷ 150 mm	F2 (K2)	35 ÷ 41 cm
Soft	S4	160 ÷ 210 mm	F3 (K3)	42 ÷ 48 cm
Flowing	S5	≥ 220 mm	F4 (Flowing)	49 ÷ 55 cm

## ABRAMS CONE

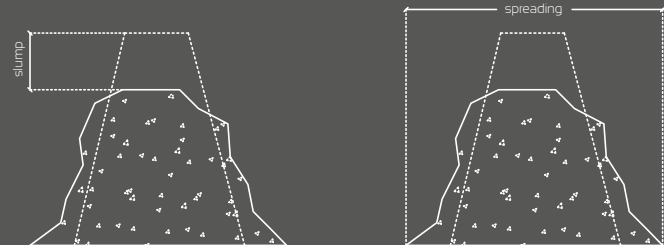

# SAFETY REQUIREMENTS

The operations of positioning, assembling, dismantling, plumbing, handling and cleaning of **GEOTUB** products, as well as the pouring of the concrete, must be carried out by competent and properly trained personal or under supervision of the site manager or a Technician of Geoplast S.p.A., who must ensure that:

- All above mentioned operations are carried out properly,
- Every person working with the formworks is equipped with suitable tools and personal protective equipment to perform all necessary actions in full compliance of the safety standards,
- All panels and the supplied accessories are checked before use, discarding those which should not meet the minimum standard of reliability and safety because of the presence of any breakage and/or deformation,
- The formwork is installed on a perfectly flat surface, so as to work safely and ensure a perfect shoring and plumbing,
- All connection, alignment and plumb accessories of the formworks are properly tightened and secured to the ground before starting the pour.

Geoplast S.p.A. disclaims any liability or responsibility arising from improper use of **GEOTUB** formwork. Any assembly of molds and/or use of accessories otherwise described in these guidelines must first be approved by Geoplast S.p.A.



rev.000 - 02/2015

Supplied by



*Making your job easier!*

09 42 68 101  
sales@everitts.co.nz  
www.everitts.co.nz