

A rustic interior featuring a stone wall, a red-framed glass elevator, a bar, and a fireplace. The scene is warmly lit with a chandelier and pendant lights. The elevator is the central focus, with a red frame and glass doors. To the left, there are stone steps. In the background, a bar with stools and a fireplace with a mounted deer head are visible.

E-MOTION PUBLIC LIFT

ACUTE

ELEVATORS







E-Motion PUBLIC LIFT

Our flagship public lift offers the ultimate in customisation and finishing options. It is unmatched in its category and can be fully customized to meet the specific needs of the client.

SPEED: 0.15 M/S



The e-motion public lift delivers a safe, smooth and comfortable user experience travelling between floors. In compliance with the Machinery Directive 200/42/UKCA

LOW PIT & HEADROOM REQUIREMENTS



With a pit depth requirement of only 130mm* or ramp can be provided. Minimum headroom of only 2250mm* from the top floor level, a market leader.

TRACTION AND HYDRAULIC OPTIONS



Both drive options are available, we work with you to offer the best solution for both the user and the property requirements.

RATED LOAD UP TO 500kg*

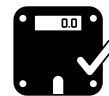

The lifting capacity is determined by the car size, different drive options and finishes allows us to optimise the load for each project.

TRAVEL UP TO 25M



Suitable for most commercial applications, with fast and simple installation.

MEETS ALL LEGISLATION REQUIREMENTS



The e-motion public lift complies with all the latest safety standards, type tested and UKCA marked.



6



FREEDOM OF DESIGN.

Its adaptability that makes the e motion Public Lift unique, not just in its exceptional ride quality, but in the unprecedented collection of material finishes, each tailored to match your design aspirations and the aesthetic of any home. With decades of experience working with Architects and Interior designers we have assembled a variety of finishes that give your property a fashionable, contemporary lift while blending in with its style and individuality.



LOW ENERGY
CONSUMPTION



VAST
SELECTION OF
FINISHES



LEADER IN
PERFORMANCE



CUSTOMISABLE
SIZES

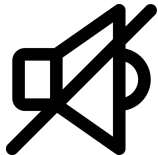

SMOOTH AND
SILENT
OPERATION

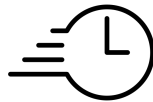

SIMPLE FAST
INSTALLATION

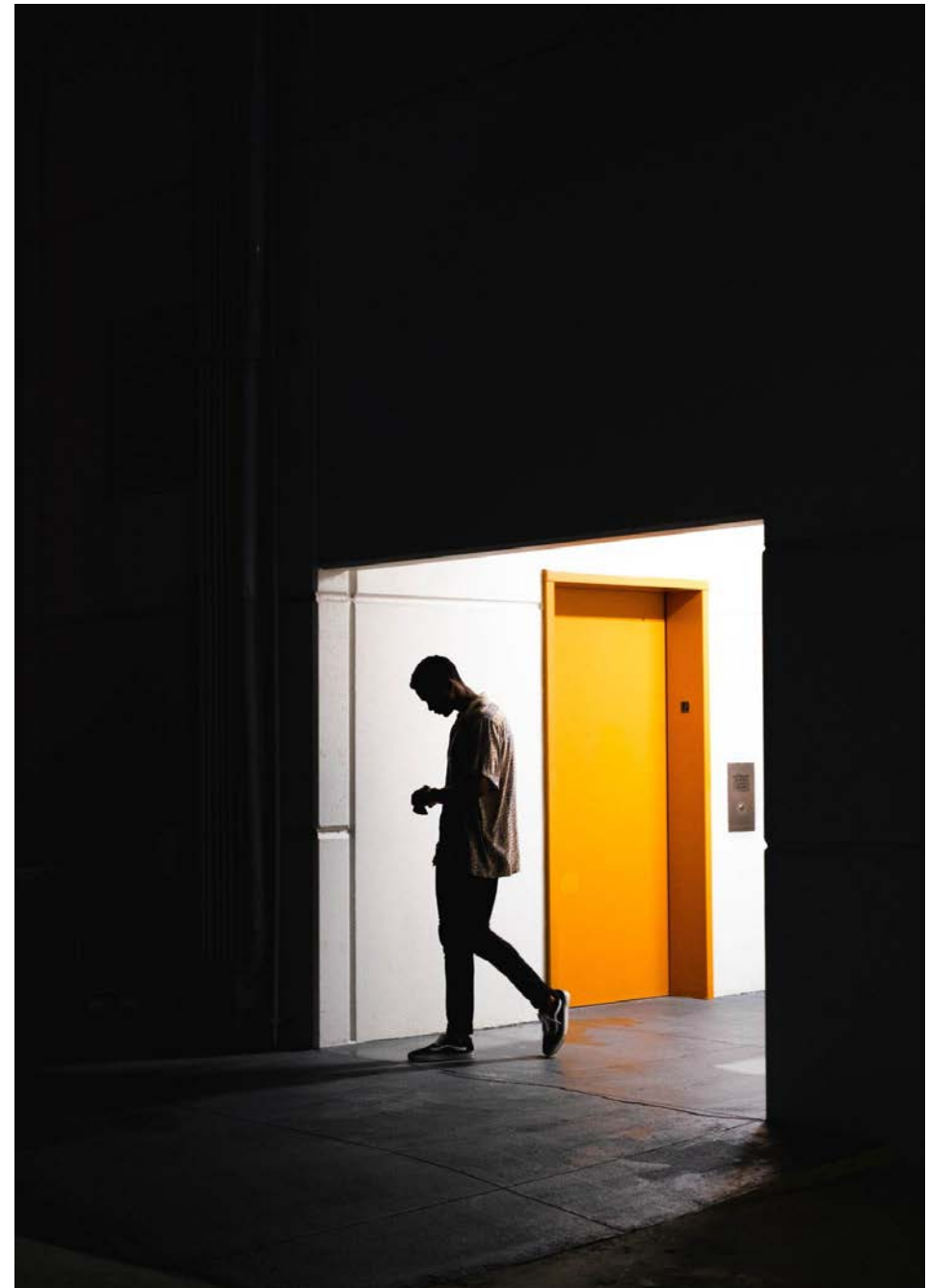

CONTEMPORARY, ELEGANT DESIGN

Starting with a blank canvas we realise your vision using premium material combinations.



SELECTION OF PUSH AND TOUCH CONTROLS

We provide several control panels that can be customised with tactile psychical buttons that have a brushed radial finish. In addition, we can add touch controls to our panels, hidden behind a sheet of superior glass.



INDUSTRY LEADING CONTROL SYSTEM

incorporating low-energy, silent drive technology to assure every trip is as pleasurable and comfortable as possible.





STRUCTURES FOR INDOOR AND OUTDOOR USE

We offer passenger lift structures when brick construction is not accessible, they offer stability and are carefully designed and certified to be structurally compliant with the lift loads, stresses and space requirements of the building. A selection of framing and cladding options including various glass types and finishes are available. Our lift structures can provide 360° panoramic viewing giving an emotional connection to the surrounding architecture. Beside adding a beautiful architectural feature, we ensure your lift is safe and reliable and complies with all current legislations. .

TOWN HOUSE
LUXURY



INSTALLATION

Installation is unintrusive and simple due to the little amount of required building work, the need for only a small pit, and the extremely low headroom requirements. In order to ensure that you can go about your normal business, we aim to complete the installation quickly and with the least possible disruption to your property or the neighbourhood.

NATIONWIDE INSTALLATIONS

We have been installing public lifts of the highest quality to commercial properties across the UK for decades. We take a personal approach to each project and ensure that all your requirements and ideas are reflected in the finished project with a swift and hassle free installation. Always following the UK's strictest quality and safety standards.





SERVICING & WARRANTY

Acute Elevators always include a full comprehensive 12 months warranty with every new lift installation, comprising of cover for all of the parts and 2 service visits annually as standard.

BOOK A CONSULTATION

Contact Acute today, we will evaluate your needs and desires, discuss the available options and start designing the perfect lift package solution.



0203 410 0495 - LONDON

0161 523 6299 - MANCHESTER



info@acute-elevators.co.uk



www.acute-elevators.co.uk



A photograph of a person's hands selecting wood and fabric samples. The scene includes a wooden plank sample board, a color palette with various shades, a roll of fabric, and other design materials on a table. The text 'FINISHES & ACCESSORIES' is overlaid in white on a dark background.

FINISHES & ACCESSORIES

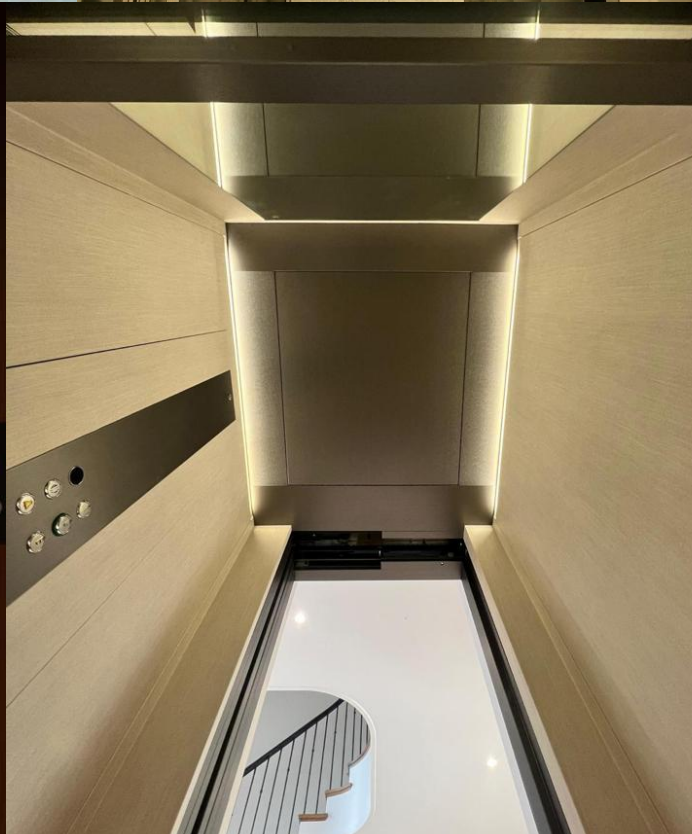



CABIN WALL FINISHES

SKINPLATES & LAMINATES.

We provide robust textured finishes in our skinplate and plastic laminate product lines. They have hygienic, easy-to-clean matte and glossy surfaces. They can offer a premium appearance with surfaces that look strikingly like natural "steel" and "wood."

SKINPLATE (STANDARD)



F12PPS
SIMILINOX



F41PPS
STAINLESS LOOK

A490PP
MATT WHITE



N3S
MATT BLACK

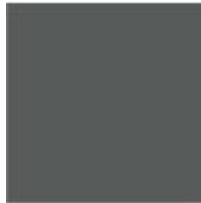

N4SA
MATT DARK
GREY



PPS11
IVORY



D29SMA
BEIGE



N11
GREY



A32PP
GLOSS WHITE



DL36A
DARK WOOD



DL8A
LIGHT WOOD

PREMIUM LAMINATED STEEL



0774
SLATE GREY



3331
CORTEN GREY



3192
COPPERFIELD
GRAY



4515
WHITE PINE



2619
SIXTY



2618
SIXTY GREEN



CABIN WALLS,DOORS & CONTROL PANEL FINISHES

POWDER COATING

The environmental choice, due to the fact that almost no pollutants are emitted into the air. Available on practically every available surface of the lift, we offer electric powder coating when a more specialised finish is required. Our powder coated surfaces are particularly durable since they can be more resistant to chipping, scratching, fading, and wearing than other finishes.





CABIN WALLS, DOORS & CONTROL PANEL FINISHES

STAINLESS STEEL

For our cabins and doors, we only use stainless steel of the greatest quality. Stainless steel is a resilient and sanitary material. Satin, textured, and super mirror surfaces guarantee a classic, high-quality finish.



BRUSHED



LINEN



MIRROR



QUAD



SUPER
MIRROR



LEATHER



STEEL COLOURS

Our stainless steel surfaces, which enhance the splendour and elegance of our cabins and doors, can be offered in traditional colours.



BRONZE
MIRROR

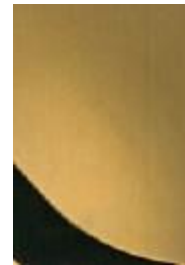

GOLD
MIRROR



GOLD
SATIN



BRUSHED
GOLD



BRONZE
SATIN

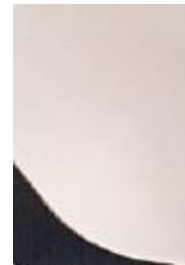

CHAMPAGNE
MIRROR



BLUE SATIN



GOLD
MATT



CHAMPAGNE
SATIN



BRUSHED
BRONZE



BRONZE
MATT



CHAMPAGNE
MATT



CABIN WALL FINISHES

WOOD LAMINATE CABINS

Graceful wood effect veneers that provide a warm appearance and elegant mid-century aesthetic. We offer 6 classic wood types to suit your interior.



4574
ICELAND
OAK



4572
LARIX
AMUR



4521
AMERICAN
ASH



4520
NATURAL
OAK



4611
BRAMBLE

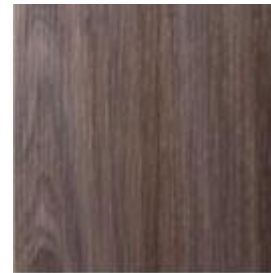

4616
CARYA
DARK

CABIN FLOORING



With amazing close-up details, the cabin flooring can act as a contrasting surface to the walls of the cabin. Our top-notch PVC and linoleum use eco-friendly materials to create vibrant colours and textures. Five different granites that offer a distinctive glitter and set natural stone apart from synthetic surfaces are available.

LINOLEUM



131-081
PRIVATE
BLACK



121-056
FOGGY
BLUE

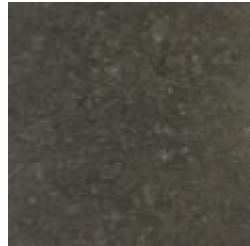

0158
TABAC
GREY



0082
BROKEN
GREY



121-019
SUNSET
ORANGE



**DOTTED
RUBBER
BLACK**

GRANITE



607
POLAR ICE



2402
DOVETAIL



607
POLAR ICE

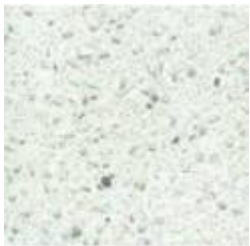

2400
WHITE

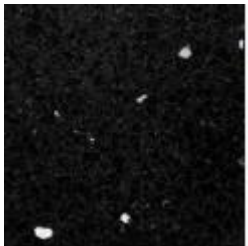

671
BLACK
STAR



**FREEDOM TO CHOOSE
YOUR OWN FLOORING***
The cabin can be provided
with a floor tray so that you
can ensure connection to
the interior space

*Flooring by customer max
20mm thick 50kg



TELESCOPIC (LANDING AND CABIN)

AVAILABLE IN 2, 3 & 4 PANEL OPTIONS, BOTH SIDE AND CENTRE OPENING

LANDING AND CABIN DOORS.

DOOR OPTIONS FOR EVERY BUILDING

We provide a variety of door solutions that allow diverse opening and usage, regardless of whether you have a limited amount of space or a certain aesthetic in mind. They may be RAL painted to match any surroundings and customised with a variety of finishes. According to European standards, our telescopic doors can withstand smoke and fire for up to 120 minutes. Smoke and fire resistance for our common swing door is up to 60 minutes.



FIRE RATED



SMOKE RATED

SWING DOOR HANDLES



QUADRA

SHORT

LONG



SOLID PANELS

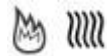

FRAMED GLASS



FULL GLASS

DIAMOND

SWING DOORS (LANDING ONLY)



SOLID C1

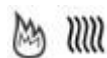

VISION PANEL

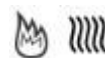

GLASS PANE

VILLA FULL GLASS

HANDRAILS

Three different handrail styles are available from us, and they can be fitted to various cabin walls. They have a natural stainless steel finish, but we also provide bespoke finishes for these designs upon request.



BRUSHED STAINLESS STEEL
(MODEL ROUND)



BRUSHED STAINLESS STEEL
(FOR NO MID RAIL ON PANORAMIC WALL)



POLISHED STAINLESS STEEL
(FOR NO MID RAIL ON PANORAMIC WALL)

MIRRORS

Mirrors have minimal framing and can be positioned on different walls of the cabin. The half height option can also be combined with a handrail.



FULL HEIGHT MIRROR



HALF HEIGHT MIRROR



LIGHTING SOLUTIONS

Energy efficient LEDs, Acute works with skilled lighting designers to develop solutions that satisfy our customers' needs.. Lighting is an essential component of any interior.

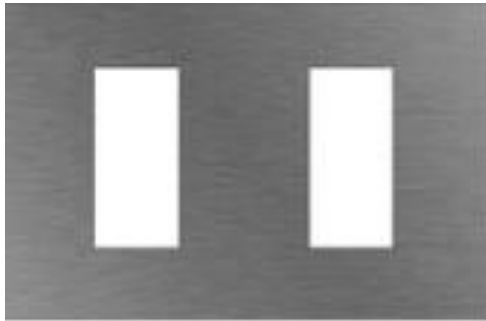

SQUARE



LED SPOTLIGHTS

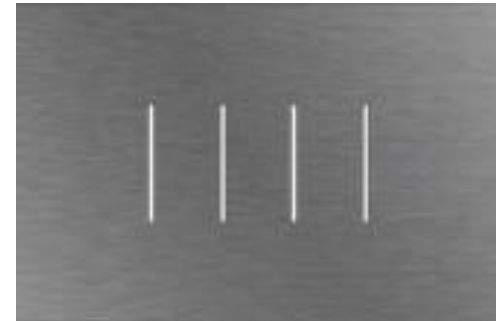

LINE



REGULAR

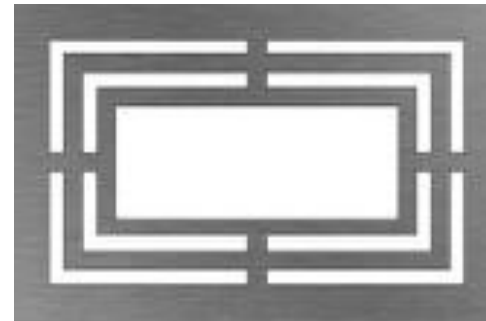

LABIRINT

Standard finishes F41PPS, F12PPS AND A490PP.
Other finishes available, Skinplates, Stainless steel or RAL painted.

A close-up photograph of a person's hand, wearing a light blue long-sleeved shirt, reaching towards a control panel. The panel features several circular buttons: a top row with buttons labeled '3' and '4'; a second row with a green button labeled '1' and a silver button labeled '2'; a third row with three buttons containing left and right arrow symbols and a '0' symbol; and a bottom row with a button containing an upward arrow symbol and a glowing blue button with a four-leaf clover-like symbol. The word 'CONTROLS' is overlaid in white, bold, sans-serif capital letters across the center of the image, partially overlapping the hand and the control panel.

CONTROLS

CABIN CONTROLS

We have a variety of control panels specifically designed for our cabins, but we can also provide an integrated solution that uses the cabin wall, a surface that may be finished in virtually every material we provide.

MODERN



- FLUSH COP
- FULL HEIGHT COP
- FLUSH PROFILES
- NO SKIRTING

CLASSIC



- RAISED PROFILES
- ¾ HEIGHT COP
- SKIRTING

STANDARD CAR OPERATING PANELS

COP



DISPLAYS



ICARO 60X60MM
BLUE



ICARO 60X60MM
BLACK



DEDALO 120X60MM
BLUE



DEDALO 120X60MM
BLACK



IRIS 7" LCD

PUSH BUTTONS



SATIN STAINLESS
STEEL

PUSH BUTTON ILLUMINATION



RED
LIGHT



BLUE
LIGHT



GREEN
LIGHT



WHITE
LIGHT

PUSH BUTTON COLOUR OPTIONS



PVD
BLACK
SATIN



PVD
GOLD
SATIN

CONTROL PANELS

AIDA

Enclosed unit for surface mounting (no need to cut out the wall)

FEATURES

- Suitable for renovation.
- 4 widths available 65, 85, 101, 201mm.
- Fixing wall mounting, without cutting or patching.
- Zamak, chrome or golden head kit.
- Flat end caps (AIDA STANDARD) are available for all types.
- 1.2 mm thick st/st surface mount faceplate for 201 width.
- 1 mm thick st/st surface mount faceplate for 65,85,101mm width.

FINISHING

- Scotch brite inox
- Mirror inox
- Satin pvd gold
- Mirror pvd gold
- Polished black
- Satin black
- Polished blue

AIDA LANDING OPERATING PANELS (LOP)



AIDA WITH 1 OR 2 BUTTONS



AIDA WITH ICARO DISPLAY (BLUE)



AIDA WITH ICARO DISPLAY (BLACK)



AIDA BLACK WITH ICARO DISPLAY (BLACK)

AIDA CABIN OPERATING PANELS (LOP)



AIDA WITH TFT DISPLAY



AIDA WITH PORTRAIT PICTURE DISPLAY



AIDA COLUMN WITH IRIS 7" DISPLAY

CONTROL PANELS

VENICE PANELS

Glass car and landing operating panels.

Available with physical push button or touch sensitive light.

FEATURES

- Glass thickness: 4 mm.
- Glass class 2B2: manufacturing process of plastic protection (Gp-Safe) in compliance with EN-12600:2004.
- Metal back boxes.
- Metal support plate.
- Automatic hidden fixing for Lop's.
- Hidden fixing with opening hinge for Cop's.
- Cop's version suitable for IRIS 7" HD position indicator.
- LOP's version suitable for IRIS 4.3, IRIS 2.8 HD and ICARO position indicators.
- Suitable for ACHILLE push buttons mounting.
- Available panels with individual patterns
- text or logos.

GLASS COLOURS

- Extra - light white
- Float black

DIMENSIONS

- Column: 250 x 1900 mm.
- LOP's with 1 or 2 push-buttons: 80 mm x 210 mm.
- LOP's with vertical tft 4.3 with 1 or 2 push-buttons: 100 x 360 mm.

VENICE LANDING OPERATING PANELS (LOP)



VENICE
1 BUTTON



VENICE
2 BUTTON



VENICE WITH
IRIS DISPLAY
(WHITE)

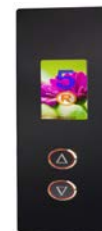

VENICE WITH
IRIS DISPLAY
(BLACK)

VENICE TOUCH LOP'S



VENICE TOUCH
WITH ARROWS



VENICE TOUCH
WITH ICARO
DISPLAY



VENICE TOUCH
WITH IRIS
DISPLAY

CAR OPERATING PANEL (COP)



VENICE COP



VENICE TOUCH COP

STRUCTURE CLADDING & FINISHING.

All of our structures can be finished to suit the surrounding space. The steel frames can be finished in an extensive range of colours or in most of the stainless steel options. Whether transparent glass or solid panels the final design will meet your expectations.

GLASS CLADDING

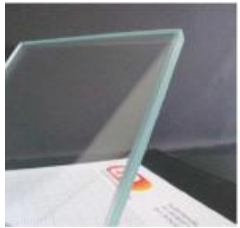

TRANSPARENT



ETCHED



MILK WHITE



SMOKED



STOPSOL
BRONZE



STOPSOL
GREY

STEEL FRAMEWORK FINISHING



BRUSHED
STAINLESS
STEEL

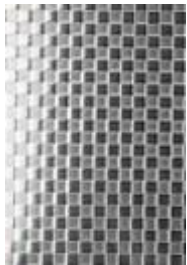

QUAD
STAINLESS
STEEL



RAL PAINTED
ANY CLASSIC
COLOUR



TRACTION DRIVE SPECIFICATION

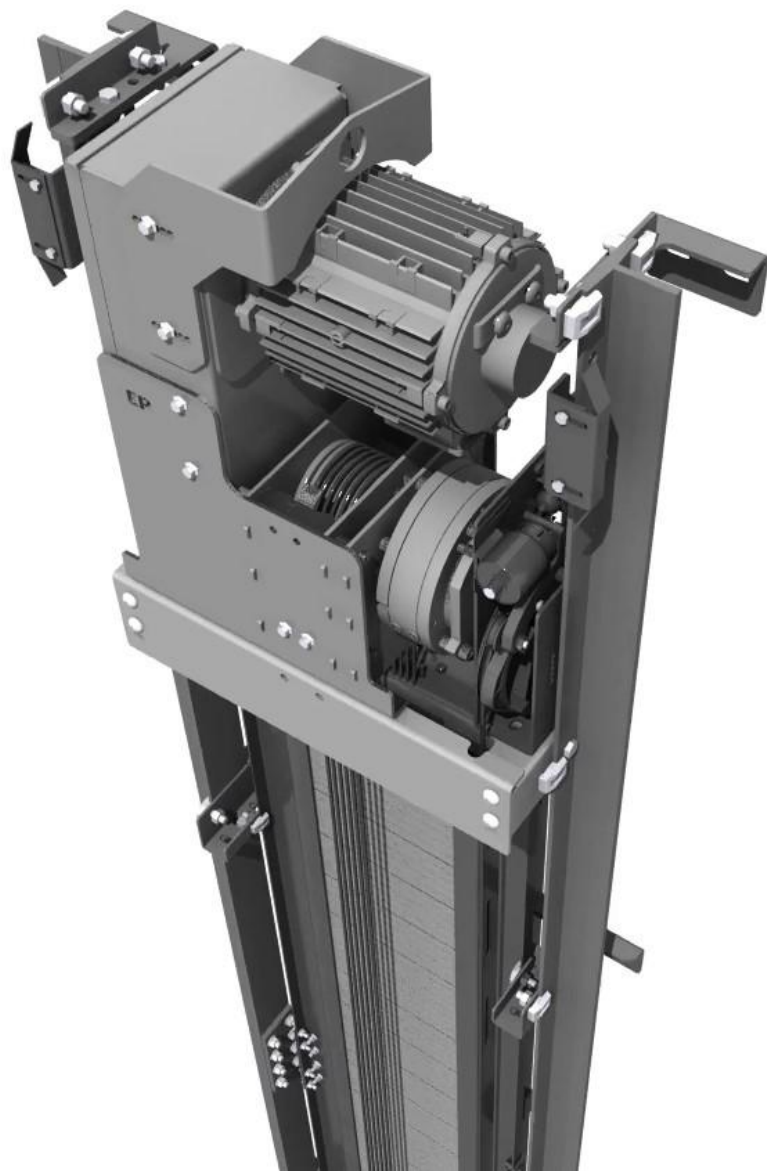

Normative	Machinery Directive 2006/42/UKCA EN-81/41
Certification Body	Bureau Veritas
Power supply	230 v single phase (+/- 5%) 50 to 60 Hz
Starts per hour	30
Duty cycle	33%
Load Capacity	300, 400 & 450kg
Accesses	Single, Through & Adjacent (inc triple entrances)
Travel (max)	25m
No of stops (max)	8
No of services (max)	8
Distance between floors (min)	400mm
Shaftway	Masonry, concrete or metal structure
Control panel	EP, e-prom motherboard.
Emergency manoeuvre	In case of power failure the cabin will rise or descend to the most convenient floor. Available uPS for bringing to defined floor as optional.
Traction	1:1 roped
Sling	Cantilever

HYDRAULIC DRIVE SPECIFICATION

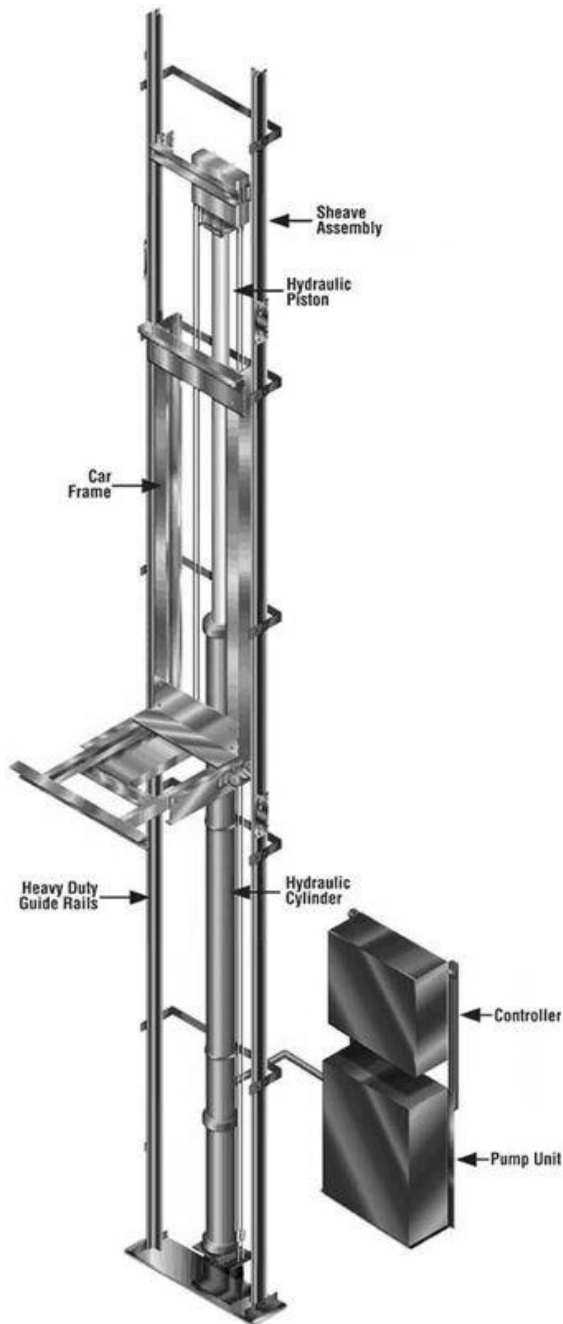

Normative	Machine Directive 2006/42 UKCA
Power Supply	230 v single phase (+/- 5%) - tension 50 or 60 Hz, 400 V three phase.
Starts per hour	30
Duty cycle	33%
Rated load - ELFO XL	300, 400, 500, 750, 1000 & 1200 kg.
Access	Single, Through, Adjacent (inc triple entrance)
Speed	0.15 m/s
Max no of stops	8 (single entry)
Max no of services	8
Minimum travel	500mm
Maximum travel	15m
Shaftway	Masonry, concrete or metal structure
Control panel	EP, e-prom motherboard
Emergency run	in case of power failure, cabin returns to lowest floor and opens the doors.
Acting	Hydraulic 2:1 roped
Sling	Standard Cantilever

ACUTE

NEW ELEVATORS

Contact:

www.acute-elevators.co.uk

info@acute-new-elevators.com

0203 410 0495 - London

0161 523 6299 - Manchester

Unit B1, Black Barns, Upper Nashenden Farm

Stoney Lane, Off Maidstone Road

Rochester, Kent, ME1 3QJ