

NIR-7000

ONLINE MOISTURE ANALYZER



Continuous Online Moisture Measurement in Challenging Industrial Process Environments

Hundreds of manufacturing facilities rely on the Industrial NIR-7000 sensor to deliver reliable non-contact moisture measurements directly in process environments for effective monitoring and control of almost any production line. As the next-generation analyzer to the Sensortech NIR-6000, the NIR-7000 features an updated optical platform designed for high-throughput industrial applications where moisture content directly impacts product quality.

Based on proven near infrared reflectance (NIR) technology for precise moisture measurements, the NIR-7000 is accurate to within +/- 0.1% moisture for many applications.

The NIR-7000 is rated IP65 for years of trouble-free operation and low cost of ownership. Hardened electronics are designed for stable operation over a wide ambient temperature range of 0 °C - 55 °C (32 °F to 131 °F). The temperature range can extend up to 85 °C (185 °F) with air vortex cooling.

EASY IMPLEMENTATION IN INDUSTRIAL ENVIRONMENTS

For many applications, the NIR-7000 can be delivered pre-calibrated based on our extensive database of calibrations for almost turn-key operation. The NIR-7000 can be situated in a variety of ways, such as over a conveyor belt, looking into an auger/screw conveyor, or looking through a sight glass window of a bin or chute.

APPLICATIONS:

- Building and wood products (fiber board, particle board, cement/sand, resin, veneer)
- Minerals and ores (acetate, bauxite, iron ore, granular material)
- Paper and textiles
- Converting (coatings, plastics)
- Chemicals and powders (coke & coal, ceramics, crumb rubber, soap flakes, fertilizer)
- Bio energy products (wood pellets, hog fuel, wood chips & shavings)



NIR-7000 FEATURES

- Entry level moisture analyzer that provides reliable and accurate results
- Improved serviceability, modular architecture, and user-friendly software makes it a significant upgrade to its predecessor, the Sensortech NIR-6000
- Global install base
- Thermal-cooled detector included
- Ready for challenging environments
- Easy integration to factory automation

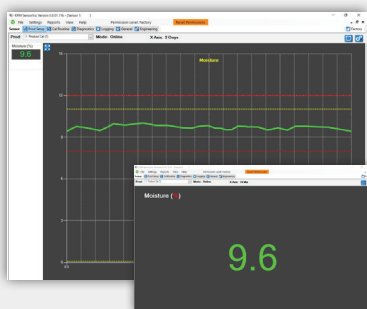

Ready to Optimize Your Production

Direct integration into your plant PLC is easy with up to four (4) 4-20 mA outputs to drive feed forward or backwards control and achieve optimal drying to maximize yield and save energy.

The NIR-7000 uses SensorVu Windows®-based PC software, allowing operators to insert set-up parameters, perform or adjust calibrations, select product codes, examine internal diagnostic values and remotely view moisture and temperature trends. SensorVu can also connect to multiple NIR-7000 analyzers in a single location for multi-system monitoring.



NIR-7000 MOISTURE ANALYZER

All NIR-7000 analyzers have a two year factory warranty for parts and labor and include the following: Powder-coated sheet metal IP65 housing, advanced digital noise filtering hardware, pre-programmed algorithms and calibrations, specialized NIR filtering to application requirements, management software, power and connection cables.

ORDERING INFORMATION

Model	Description
NIR-7000	Moisture analyzer for industrial applications

ACCESSORIES



IR Product Temp Sensor
Part# 240-021A-7000

Enables simultaneous product temperature measurement.



Snorkel Sampler
Part# 250-000A-7000 (Available in 110 VAC, 240 VAC, and 24 VDC)

Designed to measure free falling powders/granules in chutes.



Touch Screen Display
Part# 210-720A-1-7000

IP67-rated 178 mm (7 in) display equipped SensorVu™ Software.



Air Cooling
Part# 240-010A-7000

Vortex cooler attached to the sensor for high-temp applications.



Cal Check Standard
Part# 230-000A-S

Used to verify sensor stability over time and transfer calibrations between sensors.

ADDITIONAL ACCESSORIES

Part Number	Description
240-060-1A-7000	Internal heating panel assembly (110 VAC)
240-060-2A-7000	Internal heating panel assembly (240 VAC)
240-060-3A-7000	Internal heating panel assembly (24 VDC)
240-807A-7000	External product loss
250-050A-G	Insertion probe accessory
300-052-2	One (1) analog output

SPECIFICATIONS

Name	Specification
Moisture accuracy	± 0.10% (subject to application)
Moisture range	0 to 95%
Recommended measurement distance	200-450 mm (8-18 in)
Calibration codes	100
Ambient temperature	0 °C to 55 °C (32 °F to 131 °F), up to 85 °C with cooling option
Standard mount	Top or rear mount for positioning over conveyor belts, augers/screw conveyors, or looking through a sight glass window.
Dimensions W x D x H	215.9 mm x 447.0 mm x 281.9 mm (8.5 in x 17.6 in x 11.1 in)
Sensor weight	9.5 kg (21 lbs)
IP rating	IP65
Input Power	Voltage: 100-240 VAC - 50/60Hz — Power: 42 Watts; 24VDC upon request
Interfaces	Standard: Ethernet TCP/IP; Isolated 4-20mA outputs. Optional: Ethernet IP, EtherCAT, ProfiNet, ProfiBus, Modbus TCP, DeviceNet, OPC-DDE Server
Warranty	Two years parts/labor; Three years lamp replacement

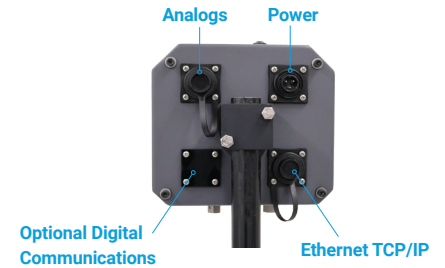

NIR-7000 offers several connection methods to meet your application and facility's unique needs.

Front View

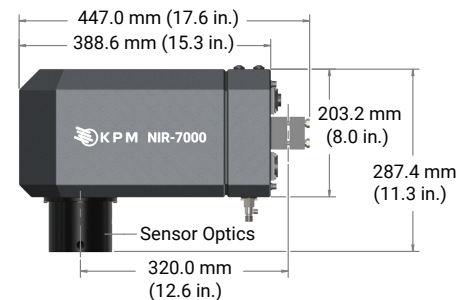

Bottom View

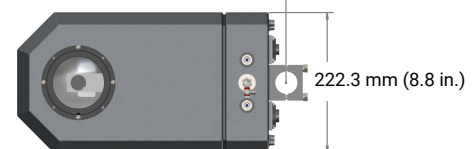

All power and interface connections on rear panel

KPM Analytics

8 Technology Drive | Westborough, MA 01581 USA
Phone: +1 774.399.0500
www.kpmanalytics.com | sales@kpmanalytics.com

©Copyright 2026. All rights reserved. 05.005.0370.EN.v4

