

Jupiter 470 - 850

weight: 126 kg

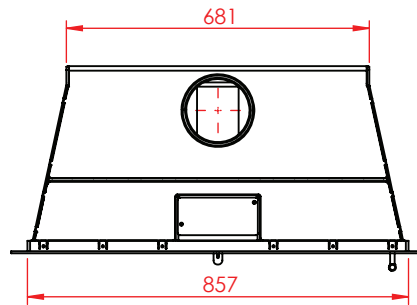

Jupiter 470 - 850

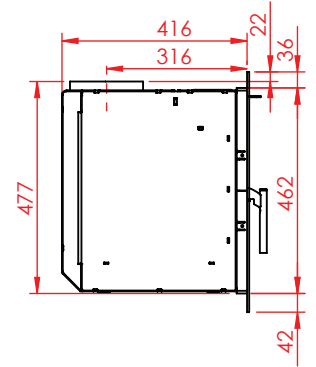
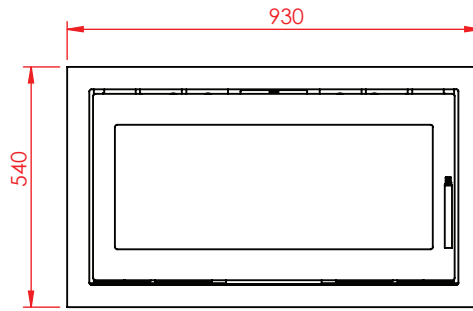
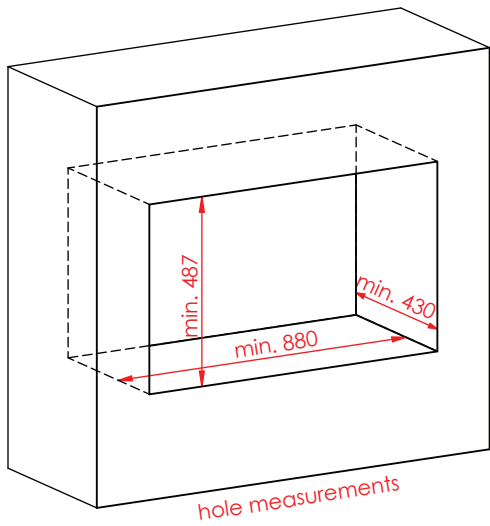
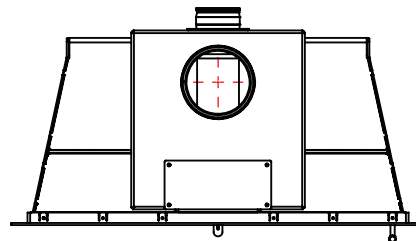
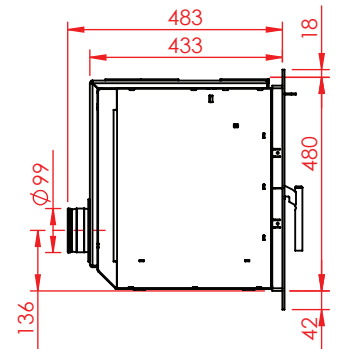
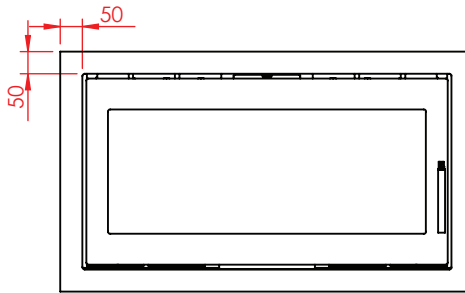
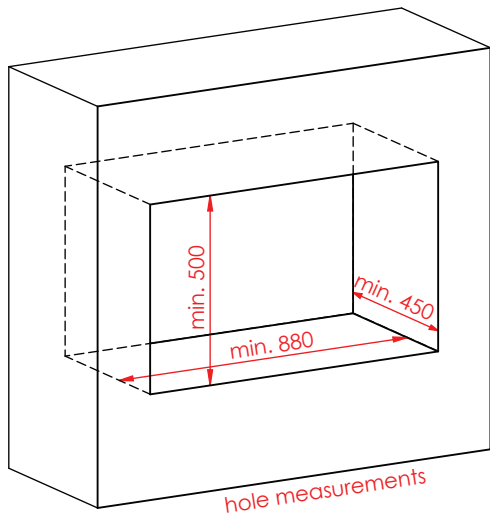

Jupiter 470 - 850, airbox behind

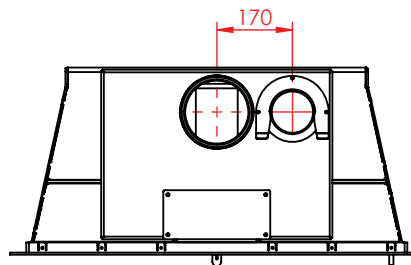
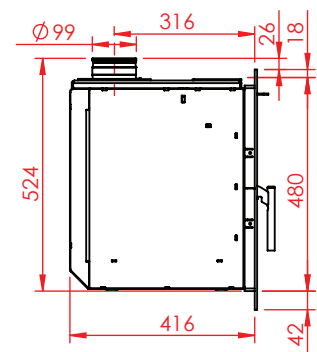
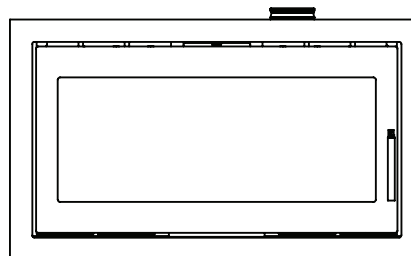
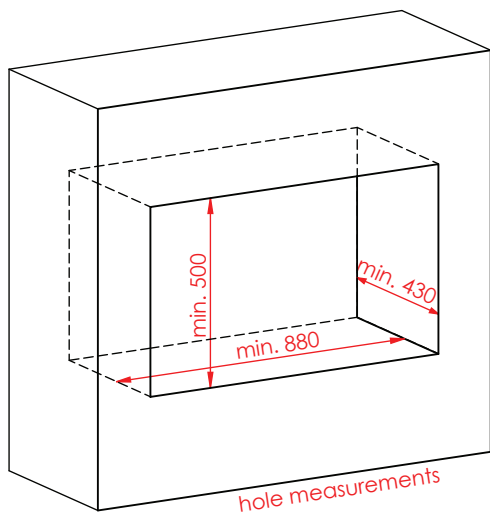

Jupiter 470 - 850, airbox on top

Clearance to combustible materials

Jupiter fireplace inserts standard

	dS	dS ¹ <small>note 1</small>	dB	dP	dL	dC <small>note 3</small>	dR <small>note 4</small>
Jupiter 470-850	400	250	400	1400	700	400	0
Jupiter 500-850	400	250	400	1400	700	400	0
Jupiter 550-850	400	250	400	1400	700	400	0
Jupiter 470 XXL	400	250	400	1400	700	400	0
Jupiter 550 XXL	400	250	400	1400	700	400	0

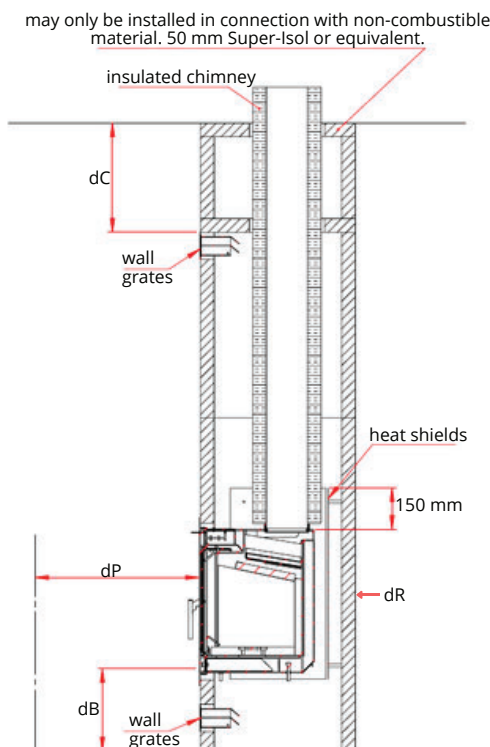
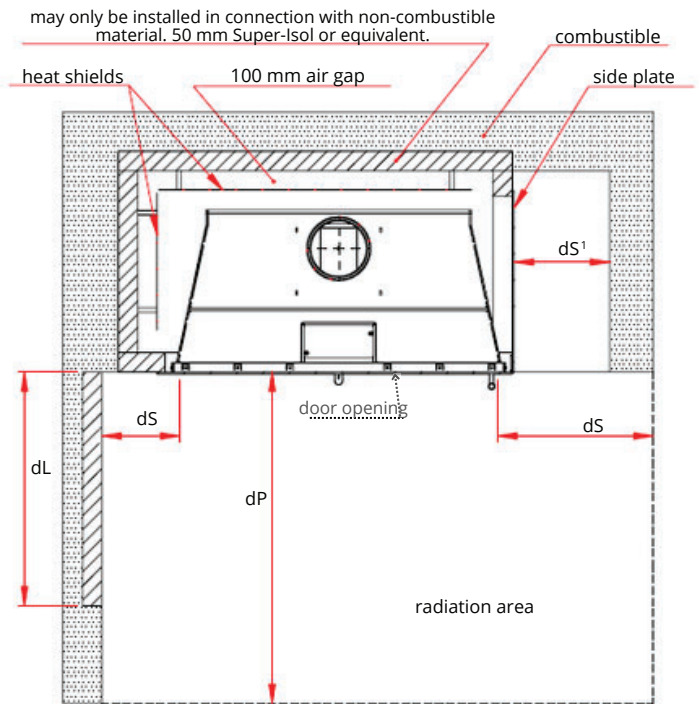
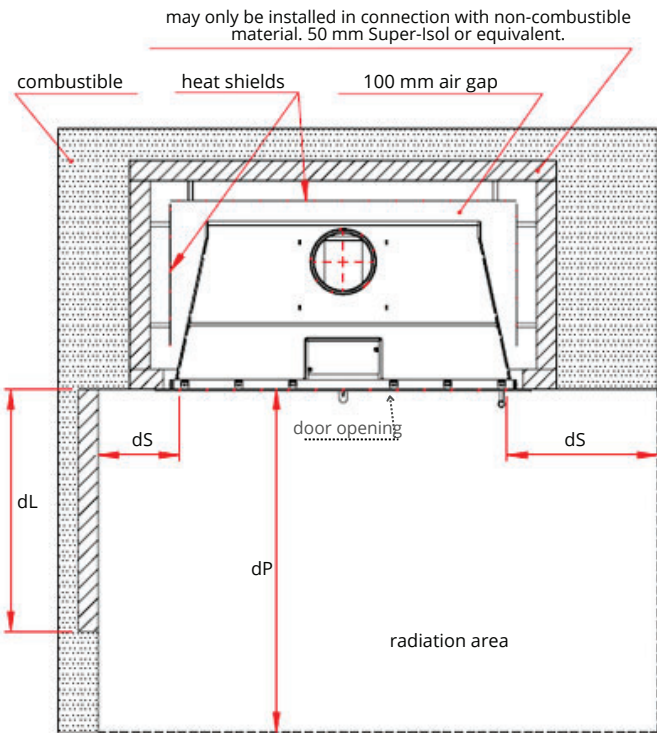

Note 1: dimension measured at a closed side plate
- measured from the edge of the door

*Be aware that the **dS** clearances in front of the insert must still be respected.*

Note 3: measured from the front edge of the door when
dS < 400 mm

Note 4: measured from the top edge of the wall grates

Heat shields: on all three sides, positioned from the bottom of the stove up to 150 mm above the top of the stove

To ensure correct air circulation within the fireplace cavity, at least 470 cm² of ventilation must be provided below and 630 cm² above the insert. The ventilation openings must be positioned as high as possible, but at least 400 mm from the ceiling.

Safety distance to staircase/combustible ceiling

If combustible staircases or a combustible ceiling are located above the fireplace insert – measured from the top edge of the door to the nearest combustible part of the staircase: **dC** min. 600 mm

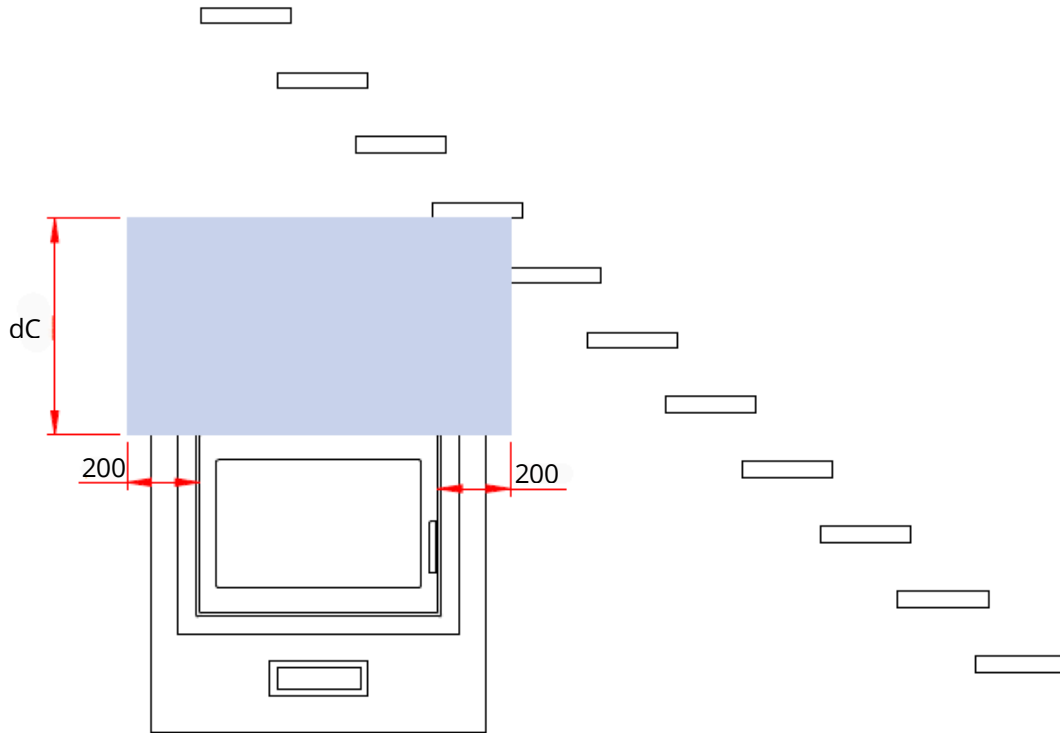

front view example at staircase