

# Jupiter 550 - 850 see through

weight: 207 kg

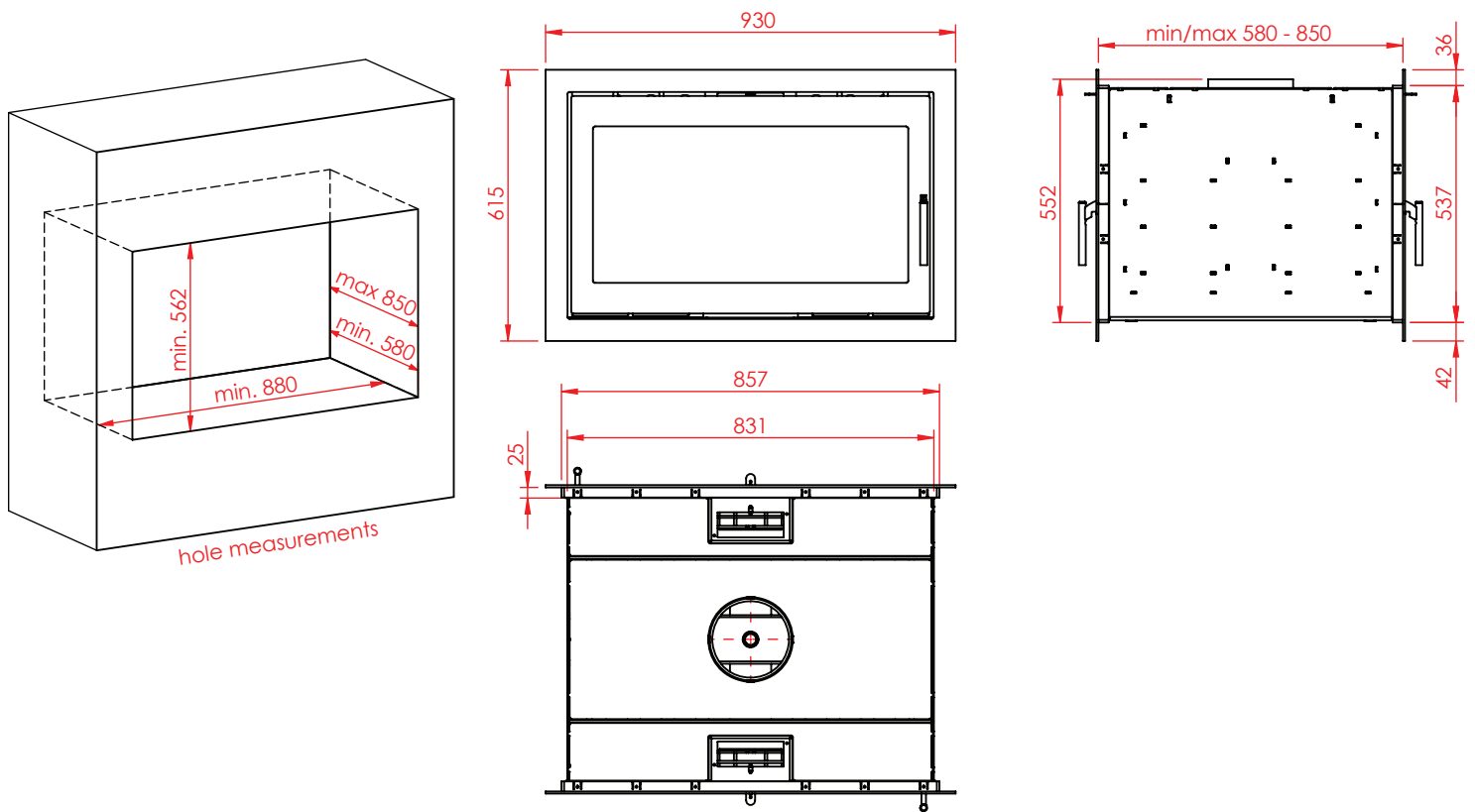

## Jupiter 550 - 850 see through

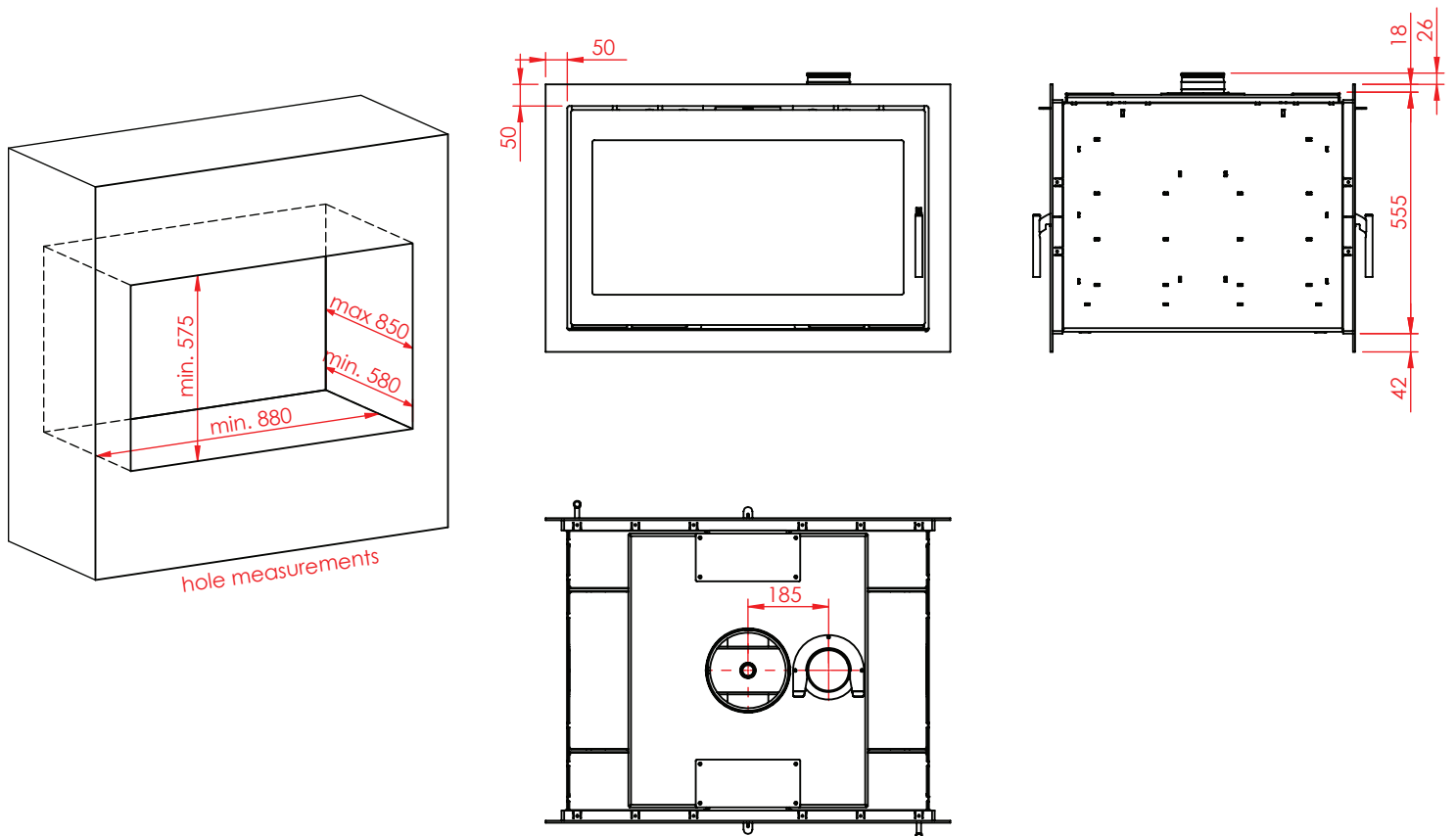

## Jupiter 550 - 850 see through, airbox on top

# Clearance to combustible materials

## Jupiter fireplace inserts see through

	dS	dS <sup>1</sup>	dF	dB	dP	dL	dC
		note 1	note 2	note 2		note 3	note 4
Jupiter 470 XL	350	250	0/650	300	1200	700	400
Jupiter 550 XL	350	250	0/650	300	1200	700	400
Jupiter 470-850	350	250	0/650	300	1200	700	400
Jupiter 500-850	350	250	0/650	300	1200	700	400
Jupiter 550-850	350	250	0/650	300	1200	700	400

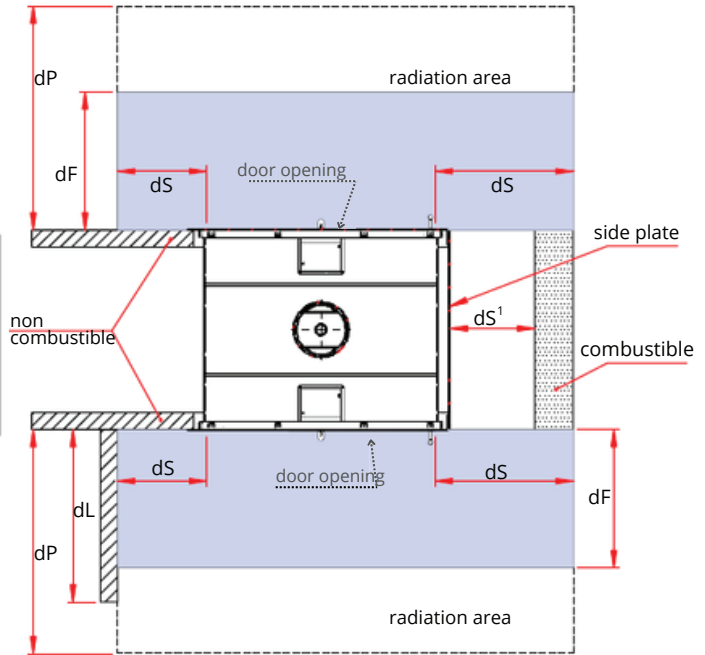
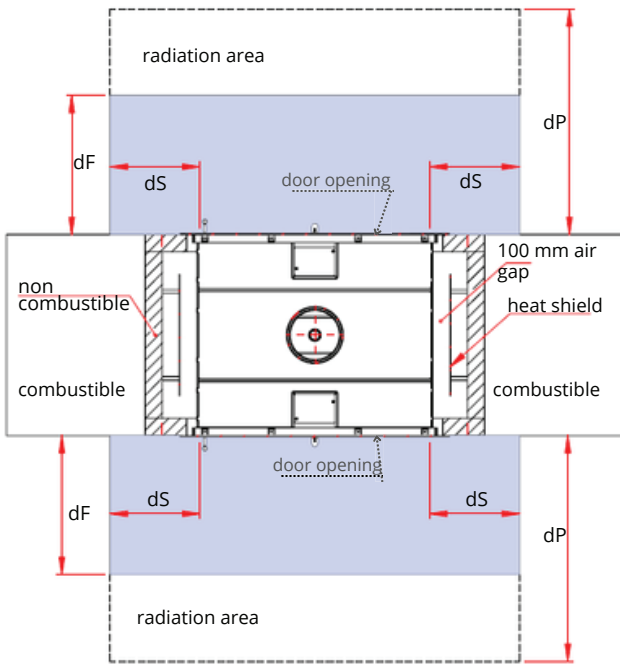

may only be installed in connection with non-combustible material. 50 mm Super-Isol or equivalent

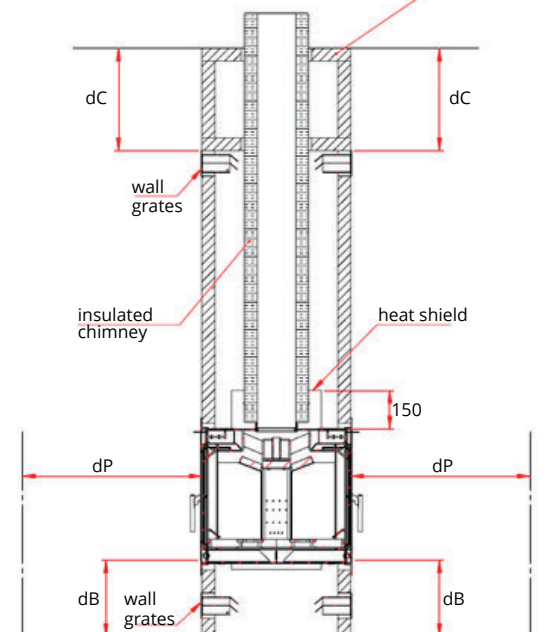

Note 1: dimension measured at a closed side plate  
- measured from the edge of the door

*Be aware that the **dS** clearances in front of the insert must still be respected.*

Note 2: safety distance to non-combustible floor  
- measured from the floor to the underside of the door edge:

**dB** ≥ 300 mm = **dF**: 0 mm

**dB** < 300 mm = **dF**: 650 mm

Note 3: measured from the front edge of the door when  
**dS** < 350 mm

Note 4: measured from the top edge of the wall grates

Heat shields: on all three sides, positioned from the bottom of the stove up to 150 mm above the top of the stove

To ensure correct air circulation within the fireplace cavity, at least 470 cm<sup>2</sup> of ventilation must be provided below and 630 cm<sup>2</sup> above the insert. The ventilation openings must be positioned as high as possible, but at least 400 mm from the ceiling.

## Safety distance to staircase/combustible ceiling

If combustible staircases or a combustible ceiling are located above the fireplace insert – measured from the top edge of the door to the nearest combustible part of the staircase: **dC** min. 600 mm



front view example at staircase