

Empowering Cloud Infrastructure Excellence

Drive Team Excellence With Expert-Led Architecting
With Google Compute Engine Corporate Training.



The Cloud Transformation Paradigm

Old State

Traditional Infrastructure



Static scaling limitations



Resource silos and inefficiencies



Isolated network management

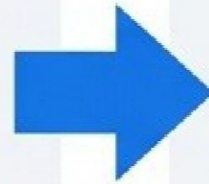

Turning Point

Google Compute Engine Integration



On-demand virtual machines

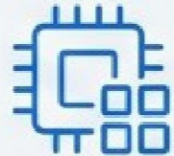

Advanced instance configurations



Integrated Identity and Access Management (IAM)



Outcome

Scalable Enterprise Architecture



Dynamic infrastructure agility



Robust security and compliance



High-performance global connectivity

Program Architecture At-A-Glance



24 - 32 Hrs



Instructor-Led



Virtual /
On-Site /
Off-Site



100+ Countries
& 10+
Languages



Course
Completion
Certificate

The Capability Activation Curve

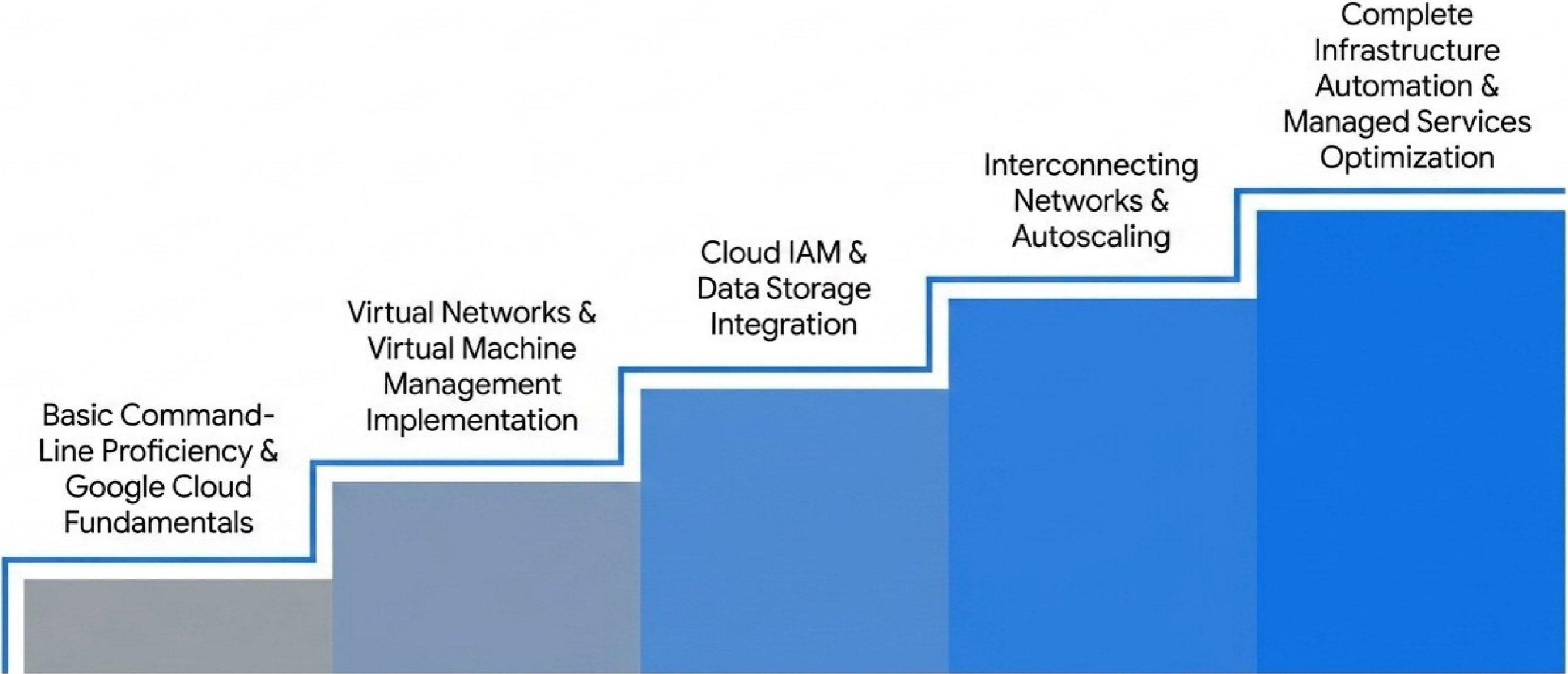

Strategic Curriculum Framework

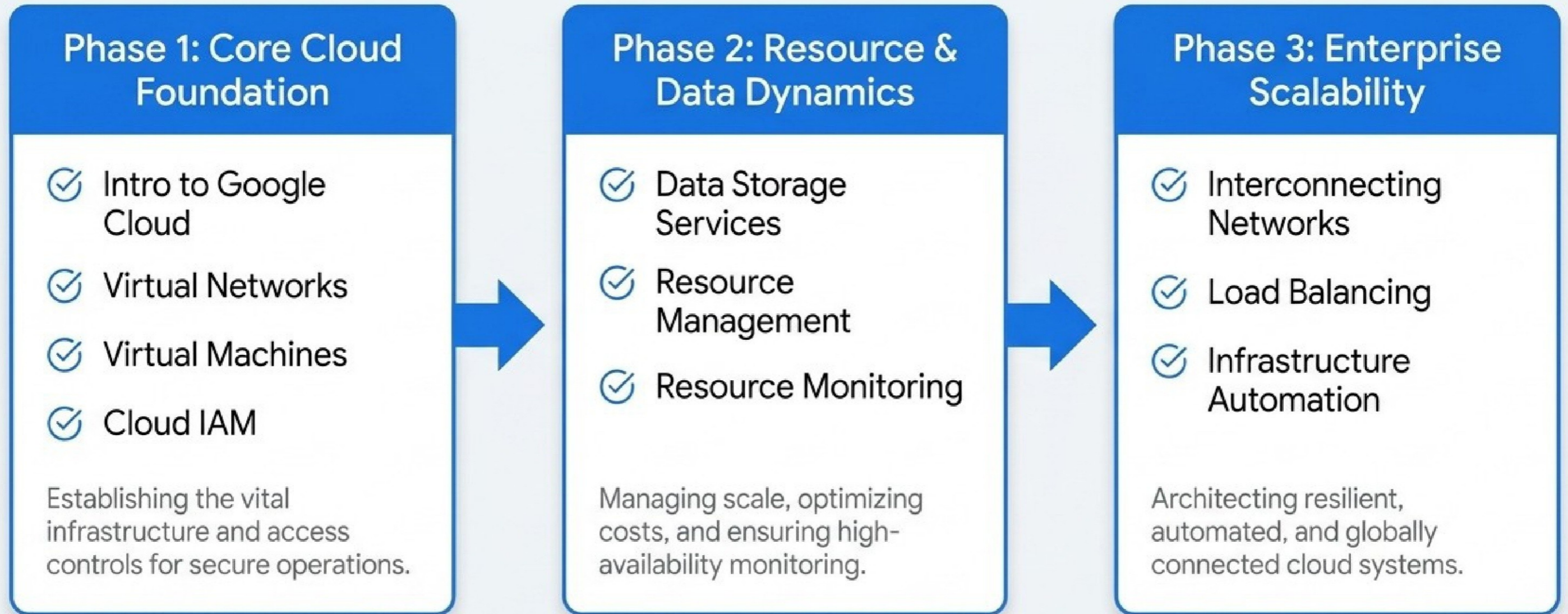

Establishing The Core Foundation

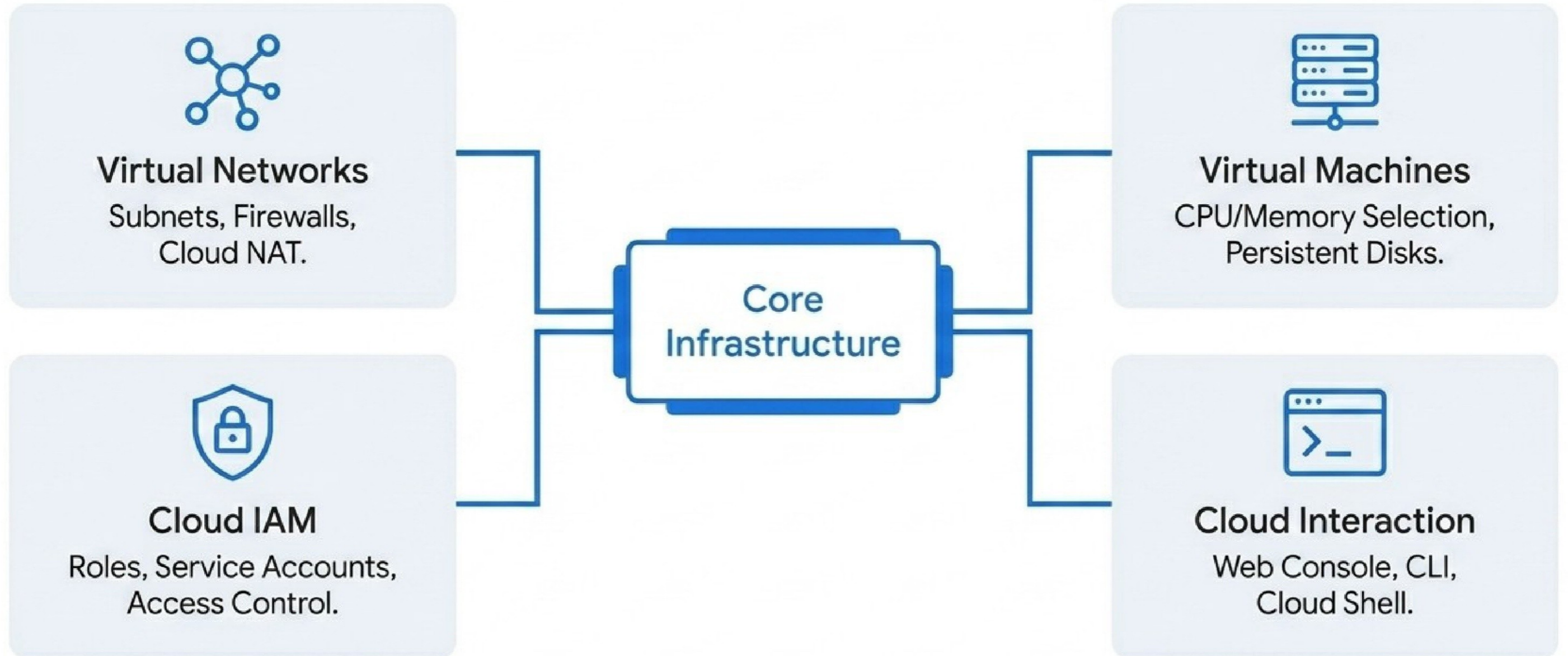

Mastering Resource Dynamics

Traditional Storage:
Static, siloed infrastructure.



Course-Enabled Cloud Storage:
Cloud SQL, Spanner,
Bigtable, Firestore.

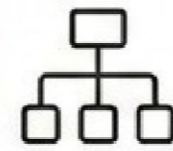

Resource Manager
Hierarchy



Quota & Budget Alerts
Management



BigQuery Billing
Analysis



Cloud Monitoring &
Error Reporting

Scaling Enterprise Operations

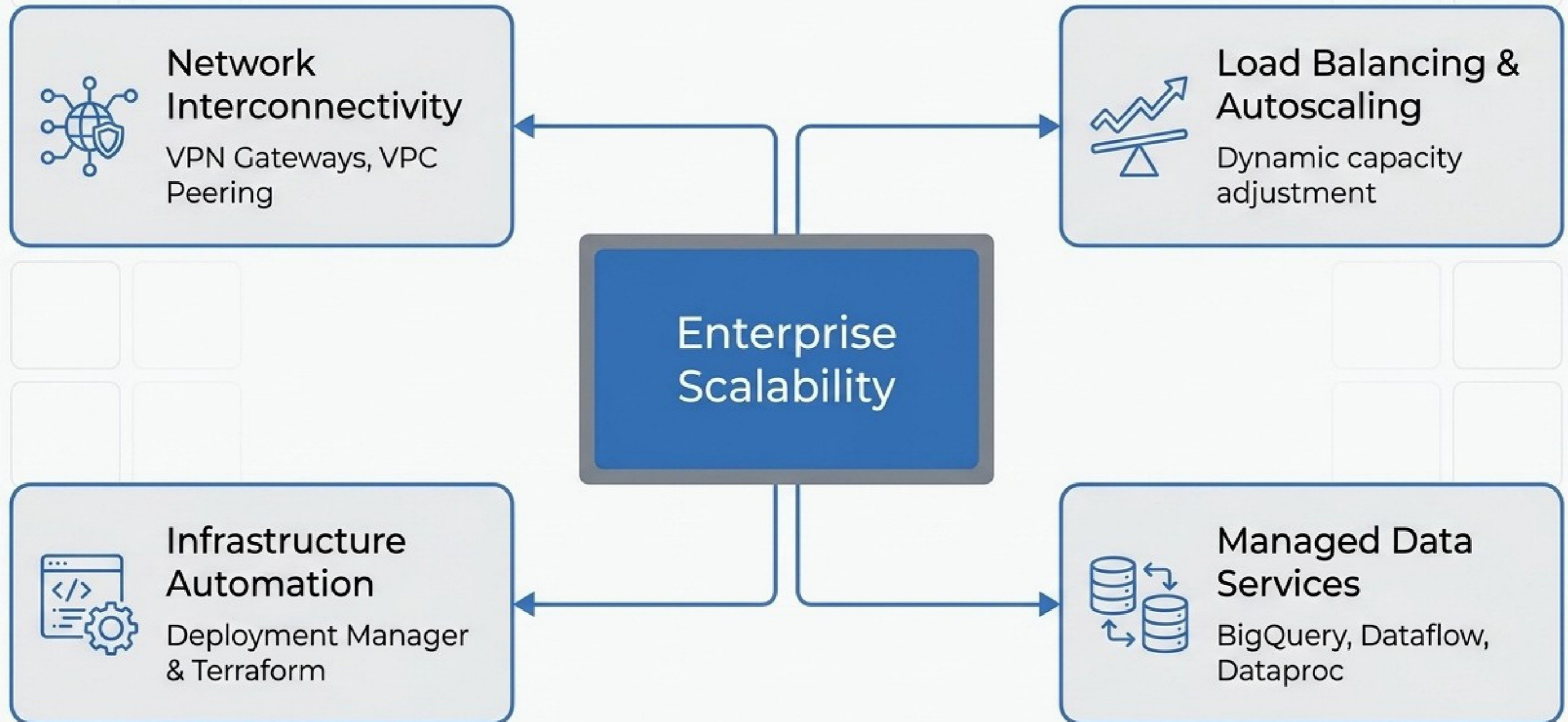

Capability Impact Diagnostic

Role	Skill & Concept	Outcome
Cloud Engineers	<ul style="list-style-type: none">✔ Virtual Machine Management ✔ CPU/Memory Optimization	<ul style="list-style-type: none">✔ Efficient Resource Utilization
System Administrators	<ul style="list-style-type: none">✔ Security Implementation ✔ Cloud IAM & Firewalls	<ul style="list-style-type: none">✔ Data Confidentiality & Compliance
Network Engineers	<ul style="list-style-type: none">✔ Networking Configuration ✔ Interconnect & Load Balancing	<ul style="list-style-type: none">✔ Reliable Connectivity & Seamless Data Transfer

The ROI Transformation Engine

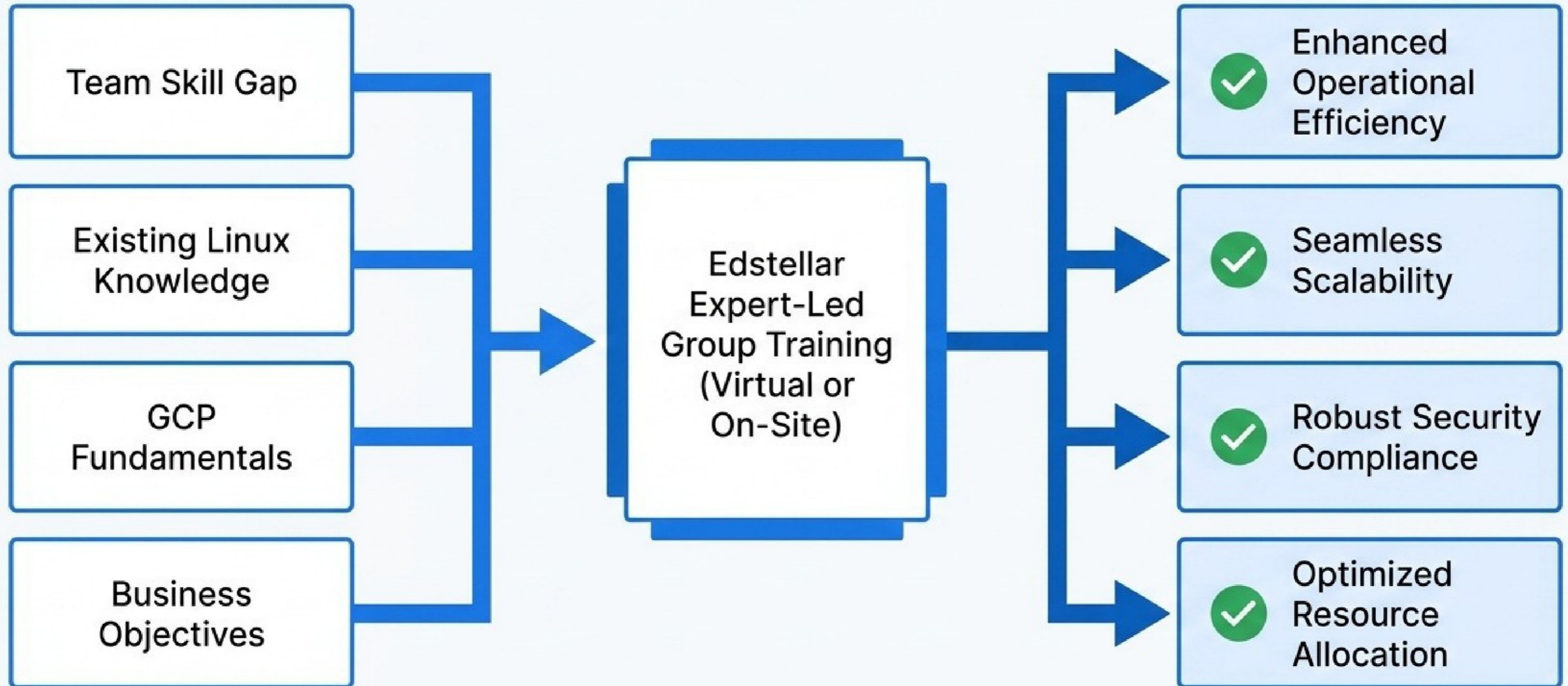

Target Audience Alignment

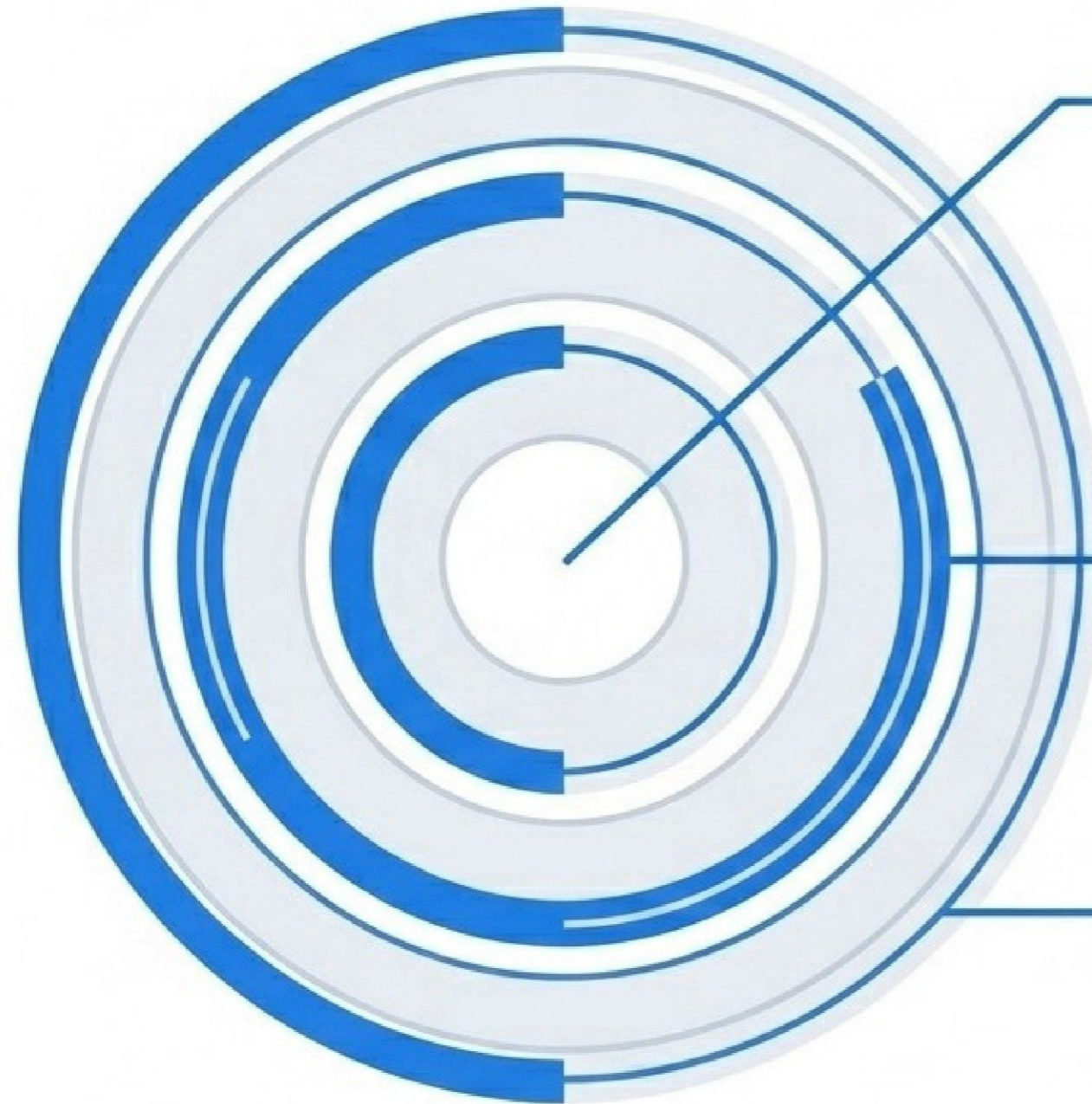

Technical Execution

Cloud Engineers, Software Engineers, Back-End Developers.

Operational Architecture

Infrastructure Engineers, Network Engineers, System Administrators, DevOps.

Strategic Management

Solution Architects, System Architects, IT Managers.

Adaptive Delivery Frameworks



Virtual Live

- Global reach capability
- Consistent training quality
- Scalable for large groups



On-Site Face-To-Face

- High engagement interaction
- Tailored workplace environment
- Improved team collaboration



Off-Site Face-To-Face

- Distraction-free learning
- Boosted employee morale
- Focused schedule

Proof of Impact

“The Architecting with Google Compute Engine training exceeded my expectations in every way... The instructor’s expertise in interactive labs made complex concepts crystal clear and actionable.”

Stewart Palmer

Senior Software Engineer

IT Services and Solutions Provider

Worldwide Delivery Ecosystem



100+
Countries
Delivered



10+
Languages
Supported
(English, Español, 普通话,
Deutsch, etc.)



