

LINSEIS

pushing boundaries

TGA L87 MSB

Magnetic
**Suspension
Balance**



WWW.LINSEIS.COM



Since 1957 LINSEIS Corporation has been delivering outstanding service, know-how and leading innovative products in the field of thermal analysis and thermo-physical properties.

Customer satisfaction, innovation, flexibility, and high quality are what LINSEIS represents. Thanks to these fundamentals, our company enjoys an exceptional reputation among the leading scientific and industrial organizations. LINSEIS has been offering highly innovative benchmark products for many years.

The LINSEIS business unit of thermal analysis is involved in the complete range of thermoanalytical equipment for R&D as well as quality control. We support applications in sectors such as polymers, chemical industry, inorganic building materials, and environmental analytics. In addition, thermophysical properties of solids, liquids, and melts can be analyzed.

Rooted in a strong family tradition, LINSEIS is proudly steered into its third generation, maintaining its core values and commitment to excellence, which have been passed down through the family leadership. This generational continuity strengthens our dedication to innovation and quality, embodying the essence of a true family-run business.

LINSEIS provides technological leadership. We develop and manufacture thermoanalytic and thermophysical testing equipment to the highest standards and precision. Due to our innovative drive and precision, we are a leading manufacturer of thermal analysis equipment.

The development of thermoanalytical testing machines requires significant research and a high degree of precision. LINSEIS Corp. invests in this research to the benefit of our customers.

C L A U S L I N S E I S
C E O D I P L . P H Y S .

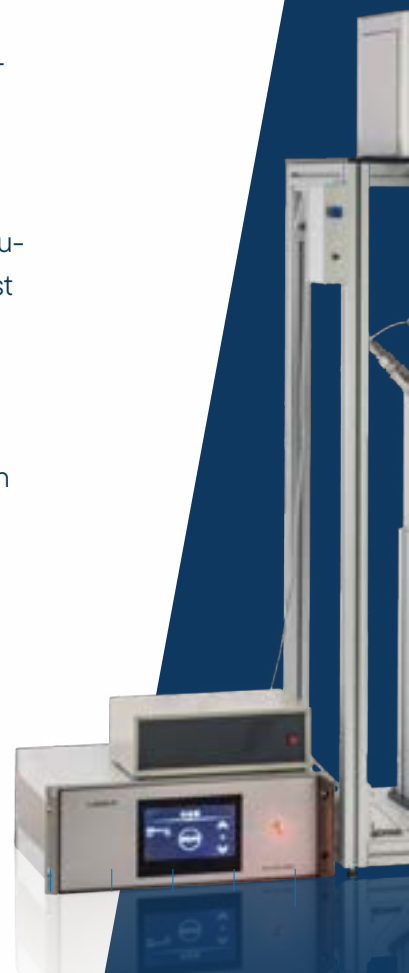

To strive for the best due diligence and accountability is part of our DNA. Our history is affected by German engineering and strict quality control.

We want to deliver the latest and best technology for our customers. LINSEIS continues to innovate and enhance our existing thermal analyzers. Our goal is to constantly develop new technologies to enable continued discovery in Science.



Engineering & Innovation

Linseis Service



Customized Solutions - The Linseis Advantage

At Linseis, we believe that every measurement challenge is unique — and so should be your instrument.

While many suppliers rely on standardized configurations, Linseis distinguishes itself through exceptional flexibility and the capability to deliver customer-specific adaptations in record time.

Our experienced engineering teams work hand in hand with you to design and implement fully customized solutions that meet your precise application requirements — whether that means a unique sensor configuration, an extended temperature range, or a specialized software integration.

With decades of experience and a modular product architecture, we turn customization into a standard service — fast, efficient, and reliable.

Choose Linseis and experience what true flexibility in thermal analysis and material characterization means.

Contact form





Service & Support

Redefining Ownership

When investing in analytical instrumentation, long-term value matters just as much as precision. That's why Linseis systems are engineered to deliver the lowest **Total Cost of Ownership** in their class — combining reliability, efficiency, and flexibility in every detail.

Our instruments are built with robust, high-quality components designed for longevity and minimal maintenance. This means fewer service interventions, shorter downtimes, and reduced operating costs over the entire product lifetime. Intelligent software updates and remote support further ensure that your system remains state-of-the-art, even years after installation.



Thermogravimetric Analysis

LINSEIS TGA analyzers set new standards in performance, precision and reliability. With exceptional sensitivity and automated processes, we ensure dependable results every time. The integrated platinum measurement system guarantees unparalleled accuracy for every measurement.

Our instruments offer the flexibility to perform analyses under a variety of conditions—whether inert, oxidative or reducing atmospheres as well as vacuum.

Trust in our TGA technology to deliver the most precise results for your applications.

Discover the power of precision with **LINSEIS Thermogravimetric Analyzers (TGA)**. These instruments are designed to measure mass changes in materials under controlled temperature conditions, providing critical insights into thermal stability, composition and decomposition behavior.

The Technique

Thermogravimetry (TGA) using a thermobalance is an analytical method in which the mass change of a sample is measured as a function of temperature and time.

This method is used e.g. to determine material compositions and is a widely used analysis method in the chemical and pharmaceutical industry.

The highly sensitive measuring system and the specially developed furnaces allow exceptionally good measurement results at extremely high heating and cooling rates in a temperature range from **-196°C to 2400°C**.

The LINSEIS TGA operate in agreement with national and international standards such as

ASTM E 1131·E 2550

ISO 17225·11358 (Part 1-3)

Magnetic Suspension Balance

LINSEIS TGA L87 MSB

The Magnetic Suspension Balance (MSB) enables precise gravimetric measurements over a wide temperature and pressure range, as well as in chemically reactive or corrosive atmospheres.

The sample holder levitates and is connected to the microbalance via the coupling of a permanent magnet and an electromagnet, allowing the measuring chamber to be hermetically sealed from the sensitive balance, thus enabling measurements under extreme conditions.

An integrated position sensor continuously detects the position of the floating magnet.

A PID (proportional-integral-differential) controller controls the electromagnetic force so that the position of the floating magnet is kept stable.

The magnetic coupling allows the sensitive microbalance to be operated outside the high-temperature or high-pressure environment.

This provides optimum protection against thermal, mechanical and chemical stresses while maintaining consistently high measurement accuracy.



Areas of application

- Gas adsorption
- Gas desorption
- Density determination of solids and liquids
- Catalyst research
- Thermogravimetric analysis under special conditions
- Moisture uptake and release
- Polymers and composites
- Energy storage and fuel technology



MAGNETIC SUSPENSION BALANCE

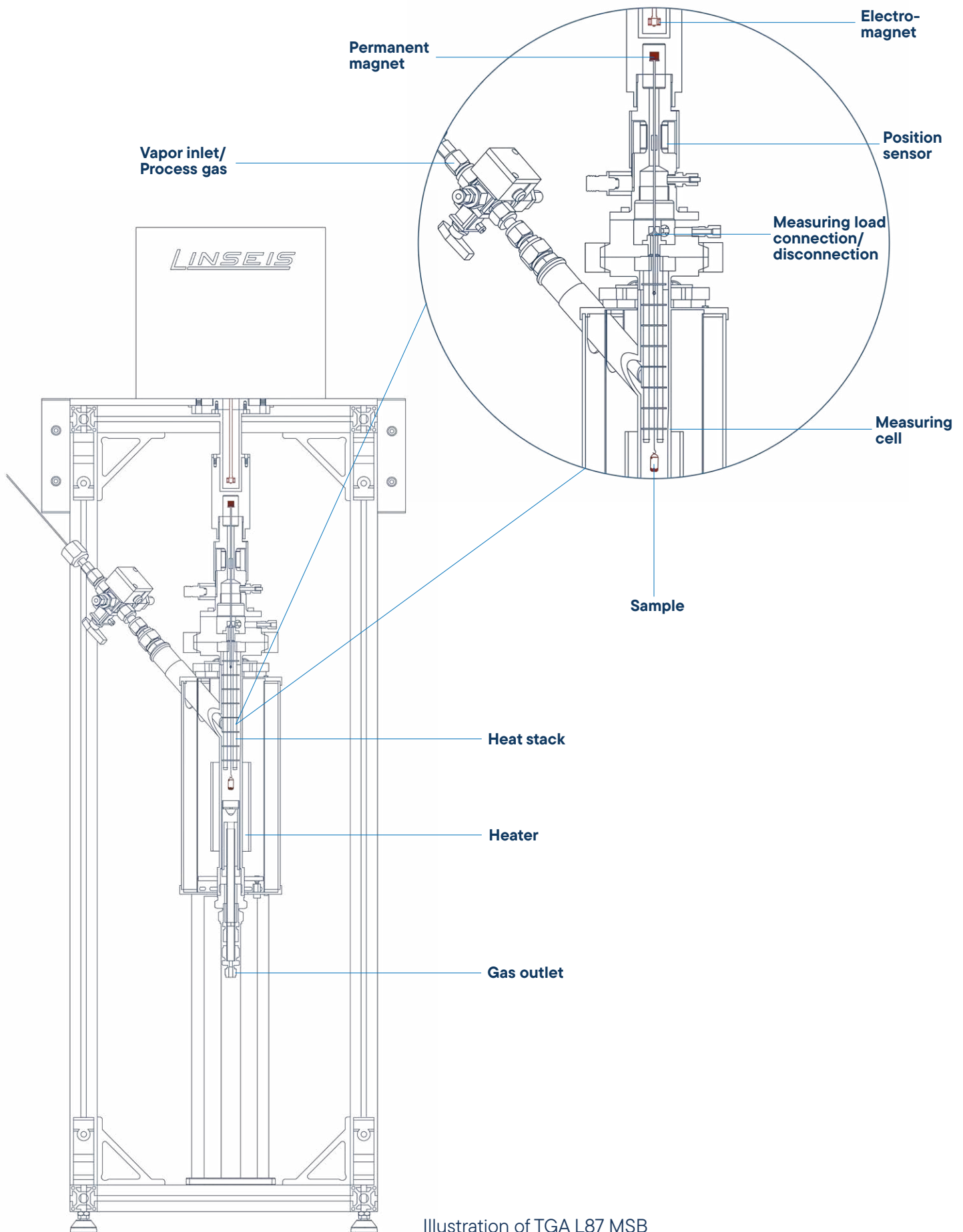
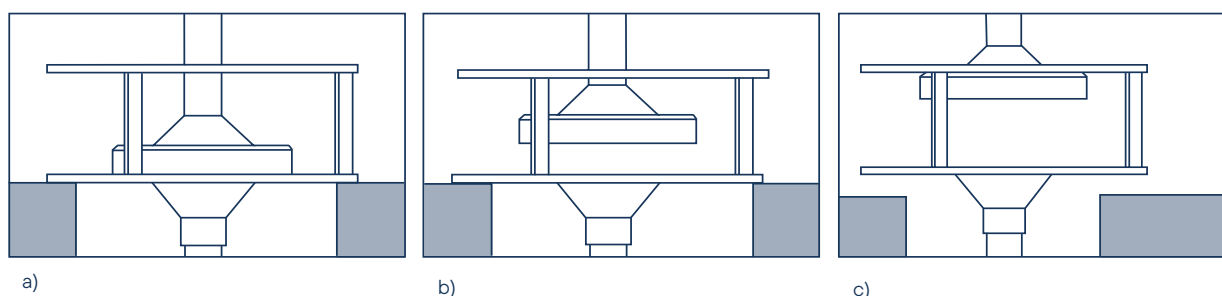

Illustration of TGA L87 MSB

Measuring Principle of the TGA L87 MSB



Default Position

In the standby position, both the lower cage and the upper cone rest on the support of the measuring system. No weighing is performed in this state, ensuring system stability and readiness for operation.

Calibration Position

During calibration, the cone is magnetically coupled and held within the cage, causing only the upper suspension rod to levitate. This allows precise determination and calibration of the balance signal under defined conditions.

Measurement position

In the measurement mode, the magnetic coupling lifts both the cage and the sample holder. The complete sample weight is transmitted to the balance, enabling accurate and reproducible measurement of the sample mass under real experimental conditions.

Forced-flow offers significant advantages in the investigation of gas/solid phase reactions

- 1. Controlled Conditions:** Precise control of reaction conditions for a reproducible environment.
- 2. Faster Reaction Times:** Acceleration of slow reactions through continuous flow.
- 3. Better Mixing:** Uniform distribution of reactants for improved reaction kinetics.
- 4. Scalability:** Easier adaptation to different volumes and flow rates for optimized production.

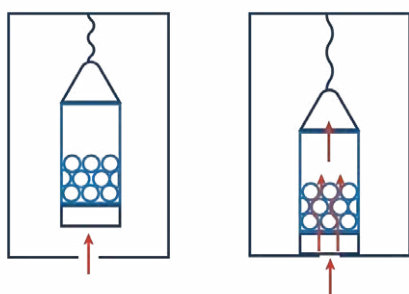

The illustration on the left shows a schematic representation of the weight measurement of a TGA L87 MSB.

The image on the right shows the principle of forced flow operation in a magnetic suspension balance. The sample gas is passed completely through the solid material and exits at the top. This significantly optimises the reproducibility, reaction control and significance of the measurement results.



Inno
solu



*uative
tions*

Unique Features

Evolved Gas Analysis (EGA):

The system can be coupled with gas analysis tools such as GC (Gas Chromatography), MS (Mass Spectrometry) or FTIR (Fourier Transform Infrared Spectroscopy) to analyze gases evolved during decomposition or chemical reactions.

High-speed data acquisition

Modern electronics enable the synchronous recording of temperature, pressure, and mass changes with high temporal resolution. This allows even fast reaction processes and transitions to be recorded and evaluated in detail.

Isolated weighing system

By enabling a hermetic isolation of the balance from the sample chamber, the non-contact weighing design eliminates the risk of damage caused by reactive gases, pressure or temperature effects.

Furnace with optical ports

The integrated optical access points allow in-situ observations during the experiment. This enables, for example, spectroscopic analyses or visual process monitoring under controlled temperature and gas conditions.

Wide temperature range -196 °C up to 2400 °C

Covering measurements from ultra-high vacuum up to 500 bar and temperatures ranging from -196 °C to 2400 °C, Linseis offers the widest range of temperature and pressure capabilities. The TGA L87 MSB is perfectly suited for an extensive variety of applications.

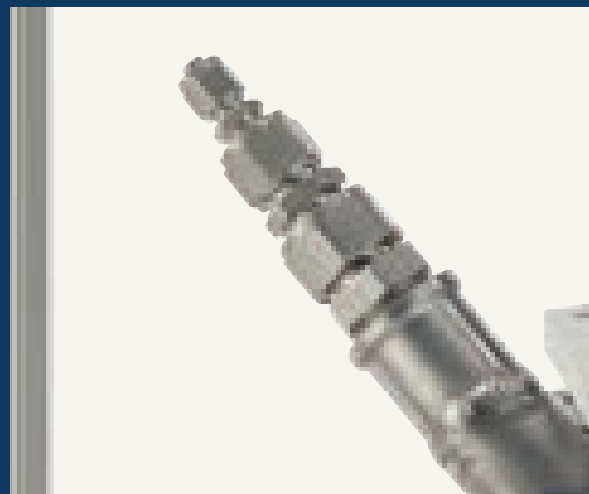



Simultaneous measurement

TGA L87 MSB enables simultaneous determination of sample and gas phase density using a dual sample configuration. Both the reaction gas density and the sample volume are measured in situ in the same chamber, ensuring automatic and highly accurate buoyancy correction. This delivers reliable results even under changing gas atmospheres and across the entire pressure and temperature range.

Gas safety system

The gas safety system is designed to accommodate various gases such as hydrogen or carbon dioxide, ensuring secure operation and user safety.



Controlled humidity and water vapour

Linseis TGA L87 MSB can regulate the humidity and water vapor during the measurement.

Customization

Close collaboration with the customers to tailor unique solutions, leveraging LINSEIS expertise to meet their specific needs.

Service

Our international presence across every continent enables us to deliver the best and fastest service possible. In addition, Linseis systems are designed for maximum reliability and longevity, ensuring a low total cost of ownership. Optimized maintenance concepts, durable components, and long-term software support guarantee sustainable value for your investment.

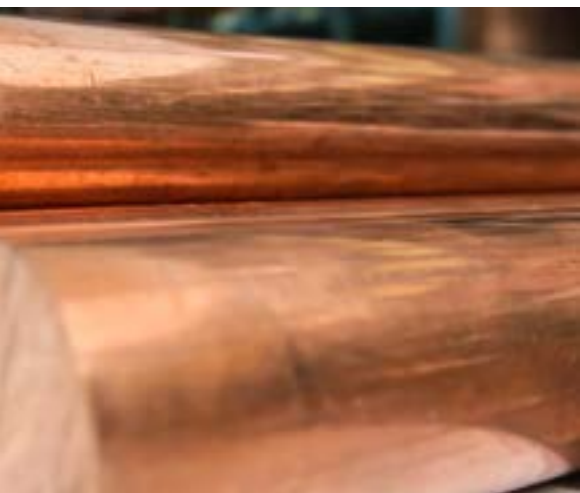



Equipment for gas control and safety (H₂, CO, CO₂, etc...)

All Linseis instruments can be prepared for the use in hydrogen atmosphere with just minor adjustments. The most important thing is a safety system that can ensure that there is no leakage and no explosive atmosphere generated outside of the instrument. Therefore, the Linseis safety system uses hydrogen sensors that are coupled to an automatic gas control panel. If there is a leakage or unwanted hydrogen release, the instrument is automatically flooded with inert gas and the hydrogen valves are closed. This ensures a minimum risk level during operation. Besides that, the system contains an optional burn off unit where the gas outlet is connected to, to ensure that also the used gas of the measurement chamber is not just released into the environment. The system can also be operated with several combinations of inert gases and even water vapor besides hydrogen.

In summary, the Linseis safety system comes with the following benefits:

- Automatic evacuation function
- Gas flow control for multiple gases including water vapor and hydrogen
- Emergency shutdown function
- Gas detector system (H₂, CO, CO₂, etc...)
- optional burn off unit
- Continuous monitoring to ensure safe operating conditions



Linseis equipment for operation under water vapor and controlled relative humidity



For many applications in thermal analysis, the atmosphere plays an important role as it may affect the sample behavior or activate reactions. Humidity influence on building materials, storage time of pharmaceuticals and foods or influence on mechanical properties of polymers are just some of the most common examples. Of course, the Linseis instruments are suitable for such experiments, however there is one fact that is often causing confusing and must be considered carefully: The difference between water vapor and relative humidity.

Relative humidity generators are most commonly used for experiments around room temperature, while water vapor applications are most often at higher temperatures. When water is heated to its boiling point or higher than that, the water changes its physical state from liquid to gaseous. It then exists as water vapor (steam). If this steam is introduced into any kind of reaction chamber or instrument, it is called water vapor application. In contrast, every gas can absorb and contain a certain amount of water at a given temperature. This is called humidity. Considering air as an example, there is always an amount of water contained in the air, even below the boiling point of water, which is defined as grade of humidity or relative humidity.



Temperature Control

The **TGA L87 MSB** offers an exceptional operating range covering measurements from **-196 °C up to 2400 °C** and vacuum conditions up to **350 bar**.

This range enables precise thermogravimetric analysis under almost all atmospheric or process conditions – from cryogenic to high-temperature and high-pressure environments.

The achievable pressure levels extend across the entire temperature range, covering most application needs with standard configurations. For specific requirements, customized setups with extended pressure capabilities or specialized gas-handling systems are available on request.

Through this modular and adaptable design, the TGA L87 MSB system can be individually configured to match your specific research or industrial requirements, ensuring maximum flexibility and long-term value.

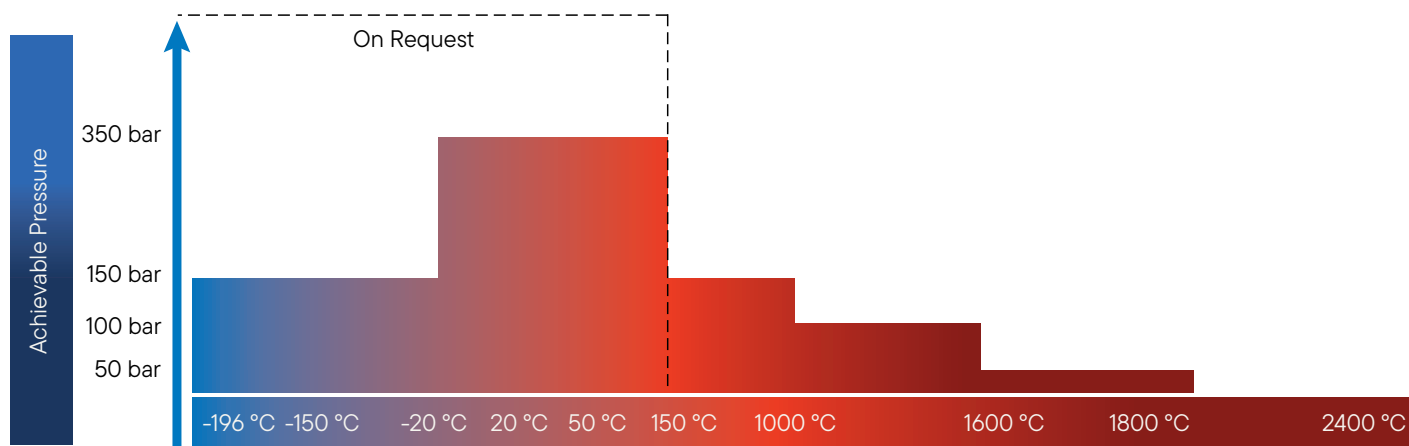

Gas/Vapor Flow Diagram

The optional gas and vapor flow system enables precise control of complex reaction atmospheres.

Multiple gas lines with individual mass flow controllers and valves allow accurate adjustment of flow rates, gas composition and pressure. Integrated safety and cooling components ensure stable operation even under high-pressure and high-temperature conditions.

The modular setup supports the introduction of gases, vapors and liquids, including water vapor via an HPLC pump, providing maximum flexibility for a wide range of experimental applications.

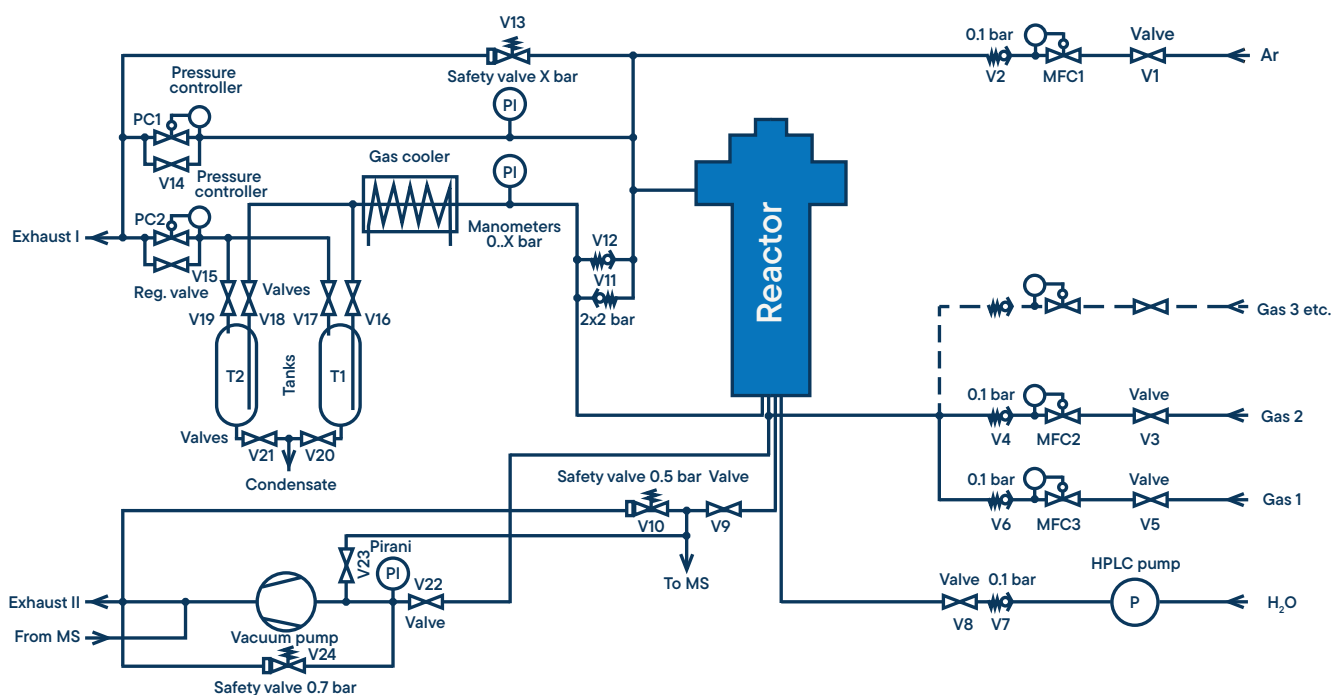

Key features

- Precise atmosphere control
- Flexible configuration
- Wide operating range
- Modular design
- Integrated safety system
- Efficient condensation and cooling
- Vacuum and purge functionality
- Glove box/Hot cell version available

Software

All LINSEIS thermoanalytical instruments are PC-controlled and operated with dedicated software under Microsoft® Windows®. The complete package is structured into three modules: temperature control, data acquisition and data evaluation.

The 32-bit software provides all essential functions for the preparation, execution and analysis of thermogravimetric measurements. Developed in close collaboration with our specialists and application experts, the software combines comprehensive functionality with an intuitive and user-friendly interface.

Software

- Program capable of text editing
- Data security in case of power failure
- Thermocouple break detection
- Repetition measurements with minimum parameter input
- Evaluation of current measurement
- Curve comparison up to 32 curves
- Storage and export of evaluations
- Export and import of data ASCII
- Data export to MS Excel
- Multi-methods analysis (DSC TG, TMA, DIL, etc.)
- Zoom function
- 1st and 2nd derivative
- Programmable gas control
- Statistical evaluation package
- Free scaling
- Automatic calibration
- Optional kinetic and lifetime prediction software packages

Features (TG)

- Mass Change in % and mg
- Rate controlled mass loss
- Evaluation of mass loss
- Residue mass evaluation
- Fully automatic, software-controlled calibration during measurement





The **LINSEIS Thermal Library** is available as an optional extension to the well-established and user-friendly **LINSEIS LiEAP** (Linseis Evaluation and Acquisition Platform) software, which is integrated into almost all of our instruments. With the Thermal Library, sample materials can be identified within just 1–2 seconds by comparing the measurement curve against a comprehensive database containing thousands of references and standard materials.

Multi-Instrument

LINSEIS instruments such as DSC, STA, TGA & LFA can be controlled with the same powerful LiEAP software platform.

Report Generator

Convenient template selection to generate customized measurement reports.

Kinetic software

Kinetic analysis of DSC, DTA, TGA, EGA (TG-MS, TG-FTIR) data for the study of the thermal behavior of raw materials and products.

Multi- Lingual

Our software is available in many different user exchangeable languages, such as: English, Spanish, French, German, Chinese, Korean, Japanese, etc.

Multi-User

The administrator can generate different user levels providing different rights to operate the instrument. An optional Log file is also available.

Database

State of the art database design enables easy data handling.

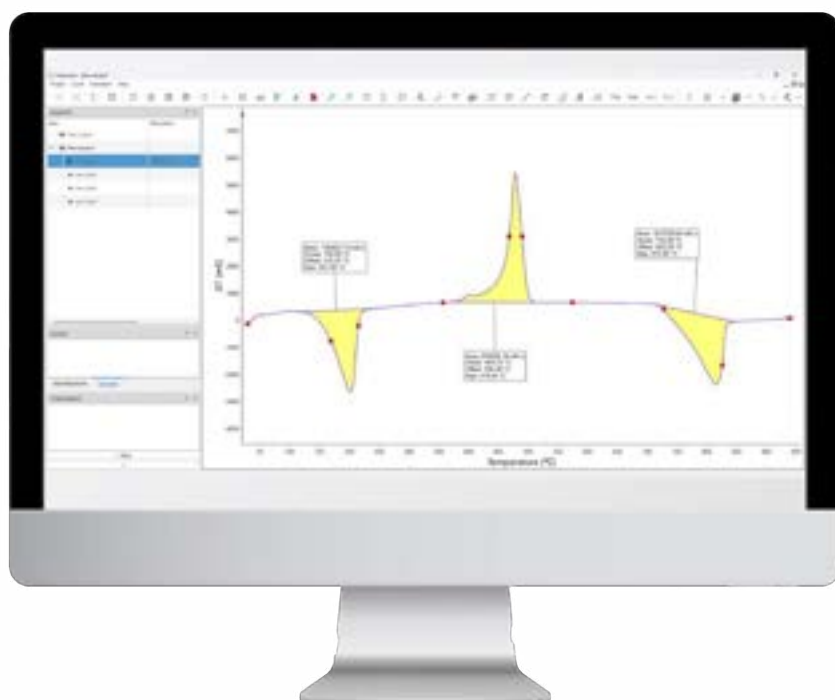



push
beyond

shing
aries

Technical Specifications

Standard MSB L87

Model	Resolution	Range	Vacuum	Pressure max.	Temperature range	Dosing system	Options
MSB-TGA-2400	10 µg/ 1 µg	25g/10g		1bar	-150 °C up to 2400 °C**	static & dynamic	Vapor
MSB-TGA-1600	10 µg/ 1 µg	25g/10g	10E ⁻⁵ mbar*	5bar	-150 °C up to 1000 °C optional: RT up to 1600 °C**	static & dynamic dynamic	Vapor Vapor
MSB-TGA-1800	10 µg/ 1 µg	25g/10g		50bar	RT up to 1800 °C	static & dynamic	
MSB-TGA-1000	10 µg/ 1 µg	25g/10g		150bar	RT up to 1000 °C	static & dynamic	Vapor
MSB-TGA-1500	10 µg/ 1 µg	25g/10g		150bar	RT up to 1500 °C	static & dynamic	Vapor

* level can be controlled ** depends on furnace

This technical specifications provided represent a non-binding exemplary overview. Detailed information tailored to specific applications or individual requirements will be made available upon request.

Contact form





LINSEIS Contract Testing

Thermal Sorption MSB L87

Model	Resolution	Range	Pressure max.	Temperature range	Dosing system	Options
MSB-HP-150-10	10 µg	25g	150bar	RT up to 400 °C Optional: -20 °C	static & dynamic	Vapor with optical ports
MSB-HP-150-1	1 µg	10g	150bar	RT up to 400 °C Optional: -196 °C/-20 °C	static & dynamic	Vapor with optical ports
MSB-HP-350-10	10 µg	25g	350bar	RT up to 400 °C Optional: -20 °C	static & dynamic	Vapor with optical ports
MSB-HP-350-1	1 µg	10g	350bar	RT up to 400 °C Optional: -20 °C	static & dynamic	Vapor with optical ports



Applications

Isothermal adsorption by Zeolite

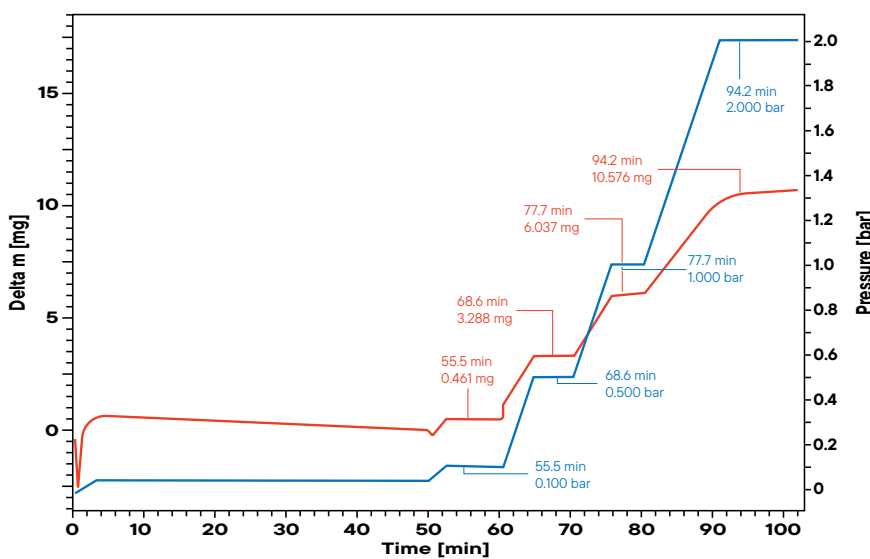

The adsorption behavior of a zeolite sample was investigated under isothermal conditions using the MSB L87. The experiment was performed at room temperature with a stepwise pressure increase from 0.1 to 2.0 bar. At each pressure step, the uptake of gas molecules by the zeolite framework was monitored through the corresponding sample mass increase. The recorded adsorption capacities ranged from 0.461 mg at 0.1 bar up to 10.576 mg at 2.0 bar. The stepwise isotherm clearly demonstrates the high affinity and capacity of zeolite materials for gas adsorption.

Adsorption of Biogas on Zeolite

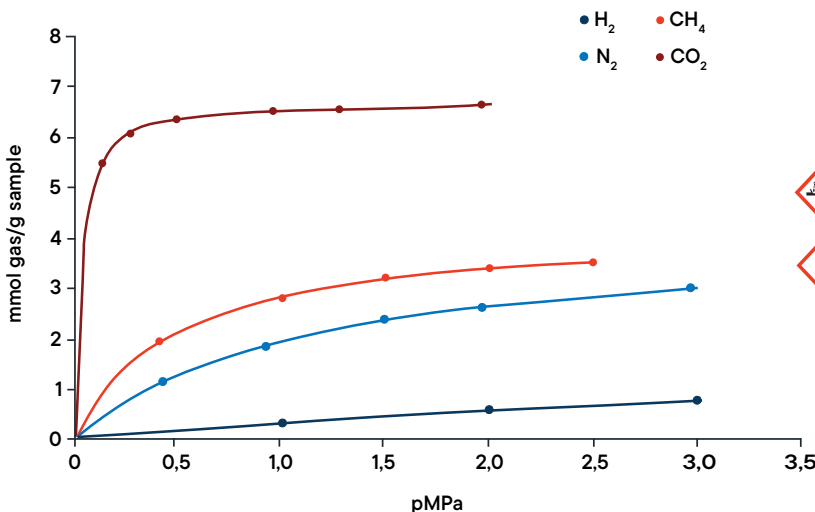

The adsorption behavior of biogas components was investigated using the LINSEIS MSB L87.

Pure gas isotherms of CO₂, CH₄, N₂ and H₂ were measured on zeolite, an industrially relevant sorbent for biogas purification. With increasing importance of biogas as an energy source, the purification of its gas components is gaining significance. In combination with an appropriate dosing system, the instrument also enables the determination of gas mixture adsorption. This experiment demonstrates the capability of the MSB for precise sorption measurements under controlled conditions.





Catalyst coking

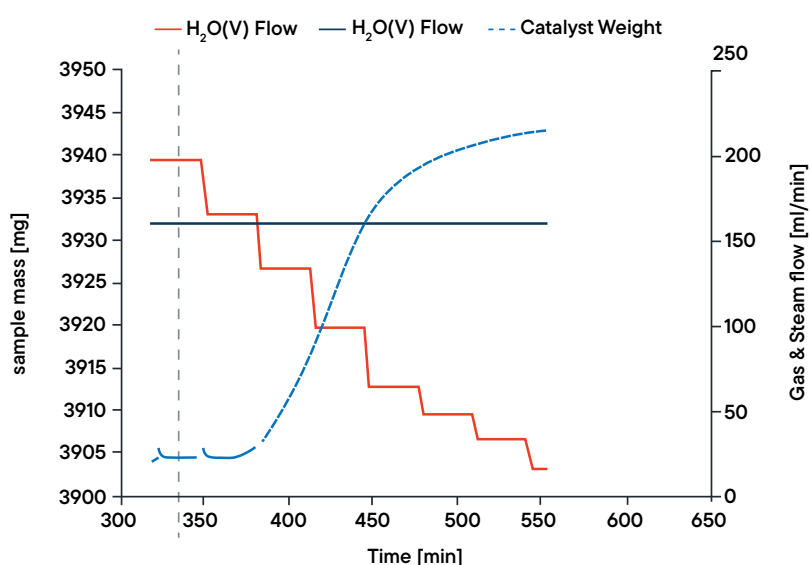

The example illustrates the formation of coke on a catalytic material under process-relevant conditions of 20 bar and 650 °C in a reactive CH₄/H₂O atmosphere. As the steam partial pressure is gradually reduced, the reaction equilibrium shifts toward carbon formation, leading to a continuous mass increase of the catalyst due to coke deposition. The maximum specific coke deposition rate determined from the measurement is 0.32 mg g⁻¹s⁻¹, highlighting the strong influence of steam concentration on the coking behavior of the catalyst.

Application example: Coal gasification

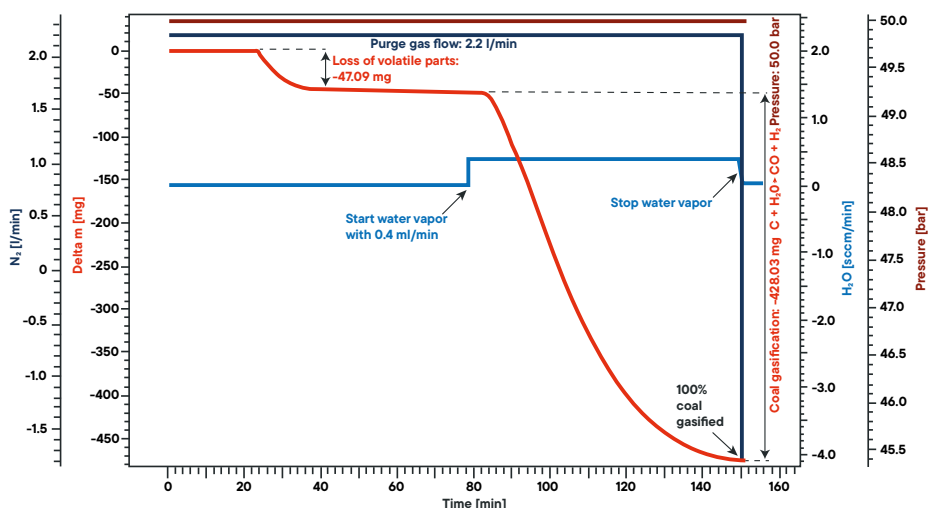

The gasification behavior of coal was studied at 50 bar using the LINSEIS MSB L87 with a purge gas flow of 2.2 l/min. Initially, the release of volatile components caused a mass loss of 47.1 mg. After stabilization, water vapor was introduced at 0.4 ml/min, initiating the coal gasification reaction. The sample showed a continuous mass decrease until complete conversion, resulting in a total mass loss of 428.0 mg. This experiment highlights the suitability of the system for kinetic investigations under high-pressure and reactive conditions.

LINSEIS

pushing boundaries

LINSEIS GmbH Germany

Vielitzerstr. 43
95100 Selb

Tel.: (+49) 9287 880 0
E-mail: info@linseis.de

LINSEIS Inc. USA

109 North Gold Drive
Robbinsville, NJ 08691

Tel.: (+1) 609 223 2070
E-mail: info@linseis.com

LINSEIS China

Kaige Scientific Park
Room 120, Building T3, No.1220
Yuqiao Road, Pudong, Shanghai

Tel.: (+86) 61 90 12 03
Tel.: (+86) 50 55 06 42
E-mail: info@linseis.com.cn

LINSEIS India

Plot 65, 2nd Floor, Sai Enclave,
Sector 23, Dwarka05-800
110077 New Delhi

Tel.: +91-11-42883851
E-mail: sales@linseis.in



WWW.LINSEIS.COM

03/2026