

CRX-K cylindrical Lock with Ligature Resistant Trim-Knob

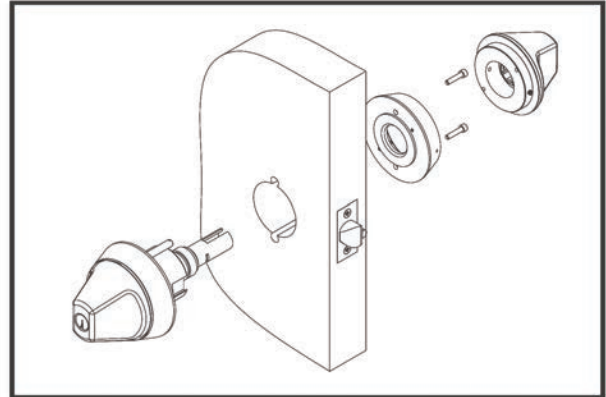

Specifications

- For facilities housing patients at risk
- For door thickness 1-3/4"-2"
- 2-3/4" backset standard, 5" optional
- Non-handed
- Refer to Function Section for available functions
- 630 (US32D) finish
- Stainless steel rose, 4" in diameter
- Stainless steel knob, ligature resistant
- Stainless steel faceplate, 1-1/8" x 2-1/4"
- Stainless steel strike, ASA, 1-1/4" x 4-7/8"
- Through-bolt mounting, tamper resistant mounting screws, for wood and metal door
- Brass cylinder with stainless steel cover, 6 pin, Schlage "C" keyway standard, 2 keys per cylinder
- Small Format IC not available
- High Security Cylinder available, TownSteel "L" keyway, 6 pin
- 10-year limited warranty

Code Compliance

- ANSI/BHMA A156.2: Meet Industry Standard
- UL/ULC: UL 10C Listed 3 Hour Fire Rating
- BAA: Meets requirements of the Buy American Act



Important Note

It is TownSteel's position that if any of our keyed locks are to be used less cylinder, whether I.C. or standard, and another manufacturer's cylinder is to be used in place of the TownSteel original manufacturer's cylinder, that a sample of that product be provided to TownSteel in advance for testing.

How to Order:	
Trim	CRX-K Ligature Resistant Knob Grade 1 Cylindrical Lock
Function	Please refer to function sheet
Cylinder	SC / L6

Example Order: TRX-L-86-SC

Functions Ligature Resistant Cylindrical Series

*Levers rotate up and down freely in the locked or unlocked positions

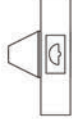
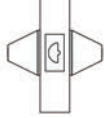
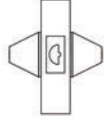
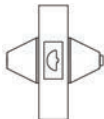
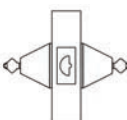
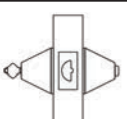
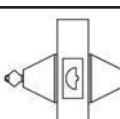
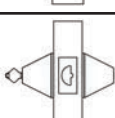
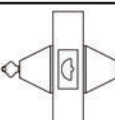
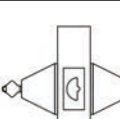
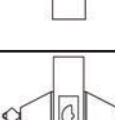
Outside	Inside	Series	Type	ANSI No.	Function Description
		CRXA-41	Single Dummy		Dummy trim on one side, blank plate on the other side.
		CRXA-72 CRXK-72 TRXL-72	Double Dummy	F72	Dummy trim on both sides.
		CRXA-75 CRXK-75 TRXL-75	Passage / Closet	F75	Latch bolt operated by lever or knob from either side at all times.
		CRXA-76 CRXK-76 TRXL-76	Privacy	F76	Latch bolt operated by lever or knob from either side. Outside lever or knob is locked by push button inside and unlocked by emergency release outside, operating inside lever or knob or closing door.
		TRXL-80	Communicating	F80	Deadlocking latchbolt operated by lever from either side. Turning key in either lever or locks or unlocks its own lever independently. Do not use on doors in rooms that have no other entrance.
		CRXA-81 CRXK-81	Entry / Office	F81	Turn/Push button locking. Pushing and turning button locks outside lever or knob requiring use of key until button is manually unlocked. Pushing button locks outside lever or knob until unlocked from outside by key or operating inside lever or knob. Deadlocking latch bolt.
		CRXA-84 CRXK-84 TRXL-84	Classroom	F84	Deadlocking latch bolt operated by lever or knob from either side except when outside lever or knob is locked from outside by key. When outside lever or knob is locked, latch bolt is operated by key in outside lever or knob or operating inside lever or knob
		CRXA-86 CRXK-86 TRXL-86	Storeroom	F86	Deadlocking latch bolt operated by key in outside lever or knob or operating inside lever or knob. Outside lever or knob is always non-active.
		CRXK-87 TRXL-87	Asylum	F87	Deadlocking latch bolt operated by key in lever or knob from either side. Both levers or knobs are always non-active.
		TRXL-109	Entry / Office	F109	Dead locking latch bolt operated by lever from either side except when outside lever is locked by the push or turn button on inside. Key outside or operating inside lever releases push or turn button unlocking outside lever except when push or turn button has been rotated to keep outside lever locked. Inside push or turn button must be manually operated to unlock outside lever. Inside lever always operates latch bolt.
		CRXK-110 TRXL-110	Classroom Intruder	F110	Deadlocking latch bolt operated by knob from either side except when outside knob is locked from the inside or outside by key. When outside knob is locked, latch bolt is operated by inside knob or unlocked by key in outside or inside knob.