

VIVID LIGHTSTRIP: SILICONE - 24V

Indoor & Outdoor Rated Linear Flex Profile - SPI-Pixel

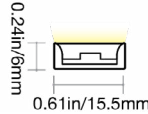

PROFILE CAPABILITIES



LIGHT SURFACE

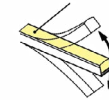

TOP BENDING

MIN BENDING DIAMETER

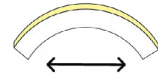

1.97IN (50MM)

CERTIFICATIONS & FEATURES*



TEMPERATURES

AMBIENT OPERATING TEMPERATURE:
2.74W/ft (9W/m): -40°F to 113°F (-40°C to 45°C)
≥3.05W/ft (10W/m): -40°F to 131°F (-40°C to 55°C)
4.57W/ft (15W/m): -40°F to 113°F (-40°C to 45°C)

MAX MOUNTING SURFACE TEMPERATURE:
185°F (85°C)

HUMIDITY (NON-CONDENSING):
0-95%

AMBIENT INSTALLATION TEMPERATURE:
-40°F to ~113°F (-40°C to ~45°C)

THERMAL MANAGEMENT:
Free Air Convection

FIXTURE STORAGE TEMPERATURE:
-40°F to 140°F (-40°C to 60°C)

FIXTURE ORDER CODE

E		A				B		
INPUT CONNECTORS	SERIES	MATERIAL	PROFILE	BENDING	JACKET/BASE + LENS COLOR	LED FUNCTION	LED COLOR	CHIP + CRI
See Page 5 to to select input connector	V = Vivid	1 = Silicone	I = LightStrip	2 = Top	N = Transparent + Transparent	5 = SPI-Pixel 6 = SPI-Pixel- RGBW	E = Red C = Green B = Blue A = Amber H = 2200K J = 2700K L = 3000K M = 3500K N = 4000K Q = 5700K R = 6500K S = RGB V = 2200- 6500K	1 = Epistar SMD LED Chip 2 = Epistar SMD LED Chip + CRI80
C	D	E		F	G			

POWER	VOLTAGE + CIRCUIT TYPE**	ORDER UNIT LENGTH	OUTPUT CONNECTOR	MOUNTING PROFILE	MOUNTING ACCESSORIES	POWER SUPPLIES & CONTROLS:
E = 2.74W/ft (9W/m) RGBW-27K RGBW-65K F = 3.05W/ft (10W/m) Tunable White G = 3.66W/ft (12W/m) Colors Whites RGB I = 4.57W/ft (15W/m) RGBW-30K RGBW-40K	2C = 24V DC CR	G = 3.94in (100mm) Tunable White H = 4.92in (125mm) Colors Whites RGB RGBW	See Page 5 to select output connector	See Page 10 to select mounting profiles	See Page 15 to select accessory	By Others By GLLS

*Maximum IP and IK ratings achievable with appropriate accessories, and cable diameter: silicone direct DMX = 0.27in (6.8mm). ** The Current Regulated (CR) Integrated Circuit extends max run length. Do not use a CC or CR power supply, as it may cause damage.

VIVID LIGHTSTRIP: SILICONE - 24V

Indoor & Outdoor Rated Linear Flex Profile - SPI-Pixel



A

MECHANICAL

ASSEMBLY

Fixtures are carefully assembled using high-quality components to ensure durability and performance. Each unit is built to meet strict specifications, with attention to electrical safety, thermal management, and optical alignment.

OVERALL & CUTTING LENGTHS

Fixtures feature defined overall lengths and specific cutting increments for easy customization. Cutting must be done at marked points to maintain proper function and consistent light output.

JACKET COLOR

The transparent silicone jacket and lens cover provide a sleek look that reveals the internal LEDs, delivering crisp, vibrant light with maximum brightness and color accuracy—ideal for applications where LED visibility enhances visual impact.

BENDING RADIUS

Do not bend smaller than allowed minimum bend diameter, or may cause damage to the light & void warranty.

OPERATION

LIGHT ENGINE

Direct DMX light engines receive DMX512 signals for precise, real-time control of brightness, color, and effects. Each unit is addressable, making them ideal for complex architectural or stage lighting setups.

ELECTRICAL

Designed to meet UL, CE, and RoHS standards, they feature overload, overvoltage, and short-circuit protection, along with low EMI and efficient thermal management for safe, reliable operation.

DIMMING

24V DC SPI systems use digital dimming via SPI-compatible controllers, such as Artnet-to-SPI or DMX-to-SPI. These allow precise, flicker-free control of each pixel's brightness and color, ideal for dynamic and custom lighting effects.

GENERAL

WARRANTY

Limited 10-Year Warranty against defects in materials and manufacturing. Coverage applies to properly installed and maintained products. Damage from misuse or improper installation is not covered. G.L.L.S. may repair, replace, or issue credit for eligible claims.

LUMEN MAINTENANCE

G.L.L.S. static lighting fixtures are tested to IES LM-84 and projected with IES TM-28 to ensure consistent lumen maintenance. Fixtures are designed to retain at least 70% of their initial brightness (L70) over a 10-year lifespan when properly installed and operated.

CERTIFICATION

Tested to UL2108 Class 2 by Underwriters Laboratory for use in the USA and Canada. Exceeds ANSI C78.377A, CE, and RoHS standards. Must be used under Class 2 ratings to maintain certification.

UL Certificate #: E347880

Report Reference #: E347880-20130503

TESTING

OPTICAL TESTING

TEST	RESULTS
Spectrum Analysis	IES LM 79 (Lumen, CCT, CRI, XY, SDCM, Wavelength)
Photometric Distribution	IES LM 79
Lumen Maintenance & Lifetime	IES LM 84 & IES TM28

TEMPERATURE TESTING

TEST	RESULTS
Normal Temperature Test	UL1598 & UL2388 & IEC60598-1 & IEC60598-2-21
Abnormal Operation Test	UL1598 & UL2388 & IEC60598-1 & IEC60598-2-21

ENVIRONMENTAL TESTING

TEST	RESULTS
Salt Water Immersion	IEC60598-1, Saltiness 4%
Salt Spray Test	IEC60068-2-11
Outdoor Exposure	Manufacturer-defined
Flame Resistance	UL94
UV Exposure	ASTMG 154, ISO 4892-3, UVA @ 340nm & 55
IPX8	EN 60598-1: 2015+A1:2018 Clause 9.2.2 & 9.2.8
Temperature Shock(Silicone)	Manufacturer-defined, -40°C - 60°C (typical temperature range)
Constant Temperature	Manufacturer-defined
12mm Needle Flame Test (Silicone)	IEC60695-11-5
650 Glow-wire Test (Silicone)	IEC60695-2-10

DURABILITY TESTING

TEST	RESULTS
Bending Test	Manufacturer-defined, 500 cycles
Tensile Test	Manufacturer-defined, > The weight of light in max.
Twist Test	Manufacturer-defined, >200 cycles
Ball Impact	UL1598 & UL2388 & IEC60598-1 & IEC60598-2-21
IK	IEC62262



VIVID LIGHTSTRIP: SILICONE - 24V

Indoor & Outdoor Rated Linear Flex Profile - SPI-Pixel



B

LED COLORS



FIXTURE SPECIFICATIONS & OPTICAL PARAMETERS

COLOR	LED COUNT	1 CONNECTOR FULL/DYNAMIC*	2 CONNECTORS FULL/DYNAMIC*	UL CLASS 2 MAX RUN**	FIXTURE COLOR TOLERANCE***	WAVELENGTH/ CCT	LED CRI	LED COLOR TOLERANCE	LUMEN COUNT	LEGACY ORDER CODE
RED	17 LEDs/ft (56 LEDs/m)	49.2ft (15m) / Not Recommended	98.4ft (30m) / Not Recommended	26ft (8m)	N/A	618-624nm	N/A	3nm	73lm/ft (240lm/m)	SS15GC153WERED24DC
GREEN	17 LEDs/ft (56 LEDs/m)	49.2ft (15m) / Not Recommended	98.4ft (30m) / Not Recommended	26ft (8m)	N/A	522-530nm	N/A	3nm	171lm/ft (560lm/m)	SS15GC123WEGRE24DC
BLUE	17 LEDs/ft (56 LEDs/m)	49.2ft (15m) / Not Recommended	98.4ft (30m) / Not Recommended	26ft (8m)	N/A	468-474nm	N/A	3nm	41lm/ft (136lm/m)	SS15GC123WEBLU24DC
AMBER	17 LEDs/ft (56 LEDs/m)	49.2ft (15m) / Not Recommended	98.4ft (30m) / Not Recommended	26ft (8m)	N/A	588-594nm	N/A	3nm	73lm/ft (240lm/m)	SS15GC123WEAMB24DC
2200K	17 LEDs/ft (56 LEDs/m)	49.2ft (15m) / Not Recommended	98.4ft (30m) / Not Recommended	26ft (8m)	3 SDCM	2238 ± 102K	82-87	2.3SDCM	171lm/ft (560lm/m)	SS15GC123WE22K24DC
2700K	17 LEDs/ft (56 LEDs/m)	49.2ft (15m) / Not Recommended	98.4ft (30m) / Not Recommended	26ft (8m)	3 SDCM	2725 ± 145K	82-87	2.3SDCM	195lm/ft (640lm/m)	SS15GC123WE27K24DC
3000K	17 LEDs/ft (56 LEDs/m)	49.2ft (15m) / Not Recommended	98.4ft (30m) / Not Recommended	26ft (8m)	3 SDCM	3045 ± 175K	82-87	2.3SDCM	220lm/ft (720lm/m)	SS15GC123WE30K24DC
3500K	17 LEDs/ft (56 LEDs/m)	49.2ft (15m) / Not Recommended	98.4ft (30m) / Not Recommended	26ft (8m)	3 SDCM	3465 ± 245K	82-87	2.3SDCM	220lm/ft (720lm/m)	SS15GC123WE35K24DC
4000K	17 LEDs/ft (56 LEDs/m)	49.2ft (15m) / Not Recommended	98.4ft (30m) / Not Recommended	26ft (8m)	3 SDCM	3985 ± 275K	82-87	2.3SDCM	220lm/ft (720lm/m)	SS15GC123WE40K24DC
5700K	17 LEDs/ft (56 LEDs/m)	49.2ft (15m) / Not Recommended	98.4ft (30m) / Not Recommended	26ft (8m)	3 SDCM	5669 ± 355K	82-87	2.3SDCM	220lm/ft (720lm/m)	SS15GC123WE57K24DC
6500K	17 LEDs/ft (56 LEDs/m)	49.2ft (15m) / Not Recommended	98.4ft (30m) / Not Recommended	26ft (8m)	3 SDCM	6532 ± 510K	82-87	2.3SDCM	220lm/ft (720lm/m)	SS15GC123WE65K24DC
2200K; 6500K; 2200-6500K	18+18 LED/ft (60+60 LEDs/m)	59.1ft (18m) / Not Recommended	118.1ft (36m) / Not Recommended	31ft (10m)	3 SDCM	2238 ± 102K; 6532 ± 510K	82-87; 82-87	2.3SDCM; 2.3SDCM	98lm/ft (320lm/m); 125lm/ft (410lm/m)	SS15GC103WEPDW24DC
R; G; B; R+G+B	17 LEDs/ft (56 LEDs/m)	49.2ft (15m) / Not Recommended	98.4ft (30m) / Not Recommended	26ft (8m)	N/A	618-624nm; 522-530nm; 468-474nm; N/A	N/A	3nm; 3nm; 3nm; N/A	32lm/ft (105lm/m); 85lm/ft (280lm/m); 17lm/ft (55lm/m); 134lm/ft (440lm/m)	SS15GC123WERG24DC
R; G; B; 2700K	17 LEDs/ft (56 LEDs/m)	32.8ft (10m) / 49.2ft (15m)	65.6ft (20m) / 98.4ft (30m)	35ft (11m)	N/A	618-624nm; 522-530nm; 468-474nm; 2725 ± 145K	N/A; N/A; N/A; 82-87	3nm; 3nm; 3nm; 2.3SDCM	32lm/ft (105lm/m); 85lm/ft (280lm/m); 17lm/ft (55lm/m); 85lm/ft (280lm/m)	SS15GC153WER2724DC
R; G; B; 3000K	17 LEDs/ft (56 LEDs/m)	32.8ft (10m) / 49.2ft (15m)	65.6ft (20m) / 98.4ft (30m)	21ft (6m)	N/A	618-624nm; 522-530nm; 468-474nm; 3045 ± 175K	N/A; N/A; N/A; 82-87	3nm; 3nm; 3nm; 2.3SDCM	32lm/ft (105lm/m); 85lm/ft (280lm/m); 17lm/ft (55lm/m); 85lm/ft (280lm/m)	SS15GC153WER3024DC
R; G; B; 4000K	17 LEDs/ft (56 LEDs/m)	32.8ft (10m) / 49.2ft (15m)	65.6ft (20m) / 98.4ft (30m)	21ft (6m)	N/A	618-624nm; 522-530nm; 468-474nm; 3985 ± 275K	N/A; N/A; N/A; 82-87	3nm; 3nm; 3nm; 2.3SDCM	32lm/ft (105lm/m); 85lm/ft (280lm/m); 17lm/ft (55lm/m); 85lm/ft (280lm/m)	SS15GC153WER4024DC
R; G; B; 6500K	17 LEDs/ft (56 LEDs/m)	32.8ft (10m) / 49.2ft (15m)	65.6ft (20m) / 98.4ft (30m)	35ft (11m)	N/A	618-624nm; 522-530nm; 468-474nm; 6532 ± 510K	N/A; N/A; N/A; 82-87	3nm; 3nm; 3nm; 2.3SDCM	32lm/ft (105lm/m); 85lm/ft (280lm/m); 17lm/ft (55lm/m); 85lm/ft (280lm/m)	SS15GC153WER6524DC

*Run length is based on a static full load with voltage drop calculated using a 0.3 m (0.98 ft) cable with silicone seamless connectors, excluding connector length—refer to specifications for details. **For UL Class 2 calculations, GLLS uses a maximum output of 96 W / 96 VA for 24 V circuits, unless otherwise confirmed by the listed driver. All runs are assumed to be single-feed from one Class 2 output. Dual-feeding from separate drivers does not qualify as Class 2 unless the run is electrically split into isolated sections. ***Silicone products maintain ≤3 SDCM within a single production run and <5 SDCM between production runs.



VIVID LIGHTSTRIP: SILICONE - 24V

Indoor & Outdoor Rated Linear Flex Profile - SPI-Pixel



C

POWER & VOLTAGE

COLOR	VOLTAGE + CIRCUIT TYPE*	POWER CONSUMPTION
RED	24V DC CR	3.66W/ft (12W/m)
GREEN		3.66W/ft (12W/m)
BLUE		3.66W/ft (12W/m)
AMBER		3.66W/ft (12W/m)
2200K		3.66W/ft (12W/m)
2700K		3.66W/ft (12W/m)
3000K		3.66W/ft (12W/m)
3500K		3.66W/ft (12W/m)
4000K		3.66W/ft (12W/m)
5700K		3.66W/ft (12W/m)
RGBW-65K		3.66W/ft (12W/m)
6500K		3.05W/ft (10W/m)
RGB		3.66W/ft (12W/m)
RGBW-27K		2.74W/ft (9W/m)
RGBW-30K		4.57W/ft (15W/m)
RGBW-40K		4.57W/ft (15W/m)
RGBW-65K		2.74W/ft (9W/m)

* The Current Regulated (CR) Integrated Circuit extends max run length. Do not use a CC or CR power supply, as it may cause damage.

D

CUTTING INSTRUCTIONS

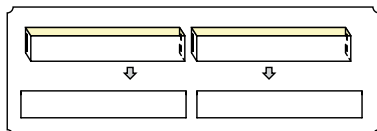
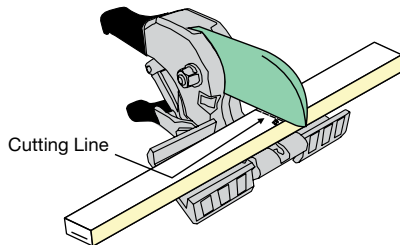
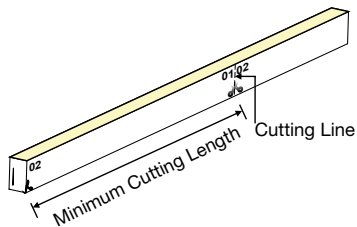

COLOR	ORDER UNIT (CUTTING UNIT)
RED	4.92in (125mm) (7 LEDs)
GREEN	4.92in (125mm) (7 LEDs)
BLUE	4.92in (125mm) (7 LEDs)
AMBER	4.92in (125mm) (7 LEDs)
2200K	4.92in (125mm) (7 LEDs)
2700K	4.92in (125mm) (7 LEDs)
3000K	4.92in (125mm) (7 LEDs)
3500K	4.92in (125mm) (7 LEDs)
4000K	4.92in (125mm) (7 LEDs)
5700K	4.92in (125mm) (7 LEDs)
6500K	4.92in (125mm) (7 LEDs)
2200-6500K	3.94in (100mm) (12 LEDs (6+6))
RGB	4.92in (125mm) (7 LEDs)
RGBW-27K	4.92in (125mm) (7 LEDs)
RGBW-30K	4.92in (125mm) (7 LEDs)
RGBW-40K	4.92in (125mm) (7 LEDs)
RGBW-65K	4.92in (125mm) (7 LEDs)



VIVID LIGHTSTRIP: SILICONE - 24V

Indoor & Outdoor Rated Linear Flex Profile - SPI-Pixel



E

COMPATIBLE CONNECTORS

PROFILE	BENDING	WIRING	INPUT CONNECTOR TYPE	INPUT ORIENTATION + TYPE	INPUT CABLE LENGTH (LEAD WIRE)
---------	---------	--------	----------------------	--------------------------	--------------------------------

OUTPUT - 02

PROFILE	BENDING	WIRING	OUTPUT CONNECTOR TYPE	OUTPUT ORIENTATION + TYPE	OUTPUT CABLE LENGTH (LEAD WIRE)
I = LightStrip	2 = Top	2 = 3 Wire (SPI Pixel) 3 = 3 Wire (SPI-Pixel Power Feed) 0 = N/A (End Cap)	7 = Snap	A = End Exit B = Bottom Exit C = Side Left Exit D = Side Right Exit E = End Jumper G = Side Jumper H = Power T-Feed Y = Middle Connector I = End Cap	1 = 0.98ft (0.3m) 2 = 3.28ft (1m) 3 = 9.84ft (3m) 4 = 16ft (5m) 5 = 32.81ft (10m) 6 = 49.21ft (15m) 7 = 65.62ft (20m) 8 = N/A
			2 = Silicone Seamless	A = End Exit B = Bottom Exit C = Side Left Exit D = Side Right Exit E = End Jumper H = Power T-Feed I = End Cap	1 = 0.98ft (0.3m) 2 = 3.28ft (1m) 3 = 9.84ft (3m) 4 = 16ft (5m) 5 = 32.81ft (10m) 6 = 49.21ft (15m) 7 = 65.62ft (20m) 8 = N/A

LEGACY CONNECTOR ORDER CODE

XX	15G	1	00	XX	XX	X	XX	XXX	X
PRODUCT TYPE	PROFILE	BENDING	LIGHT EMITTING	FUNCTIONALITY	CONNECTOR TYPE	FIXTURE END	EXIT TYPE	LENGTH	
NA = DIY Accessories FA = Factory Accessories	15G = LightStrip	1 = Top	00 = 15G	2W = Static 3W = Tunable White/SPI-Pixel 4W = RGB 5W = RGBW 0W = For End Cap	SC = Snap SE = Seamless	1 = Input Side 2 = Output Side 0 = Jumpers/T-feeds/Seamless Bottom/Seamless End 3 = Input/Output	EN = End BO = Bottom SL = Side Left SR = Side Right EJ = End Jumper BJ = Bottom Jumper TF = Power Feed EC = End Cap	0M3 = 0.98ft (30cm) 01M = 3.28ft (1m) 03M = 9.84ft (3m) 05M = 16ft (5m) 10M = 32.81ft (10m) 000 = For End Cap	P = Power or For End Cap S = Signal & Power



GLLS.COM | 1-888-580-6366

GLLS reserves the right to make any design changes for continuous improvement which will not affect the overall appearance or performance. REV. 20260602

VIVID LIGHTSTRIP: SILICONE - 24V

Indoor & Outdoor Rated Linear Flex Profile - SPI-Pixel



E

SNAP CONNECTOR

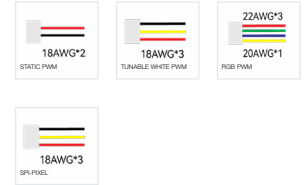

NOTES:

1. Connector Tolerance ± 0.02 in (0.5mm)
2. Cable diameter: Static, Tunable, RGB & SPI Silicone = 0.26in (6.5mm)
3. Do not apply force to the feed cable
4. Ensure Max. Cable Lengths are followed according to wire gage to avoid voltage drop

IP67, tool-less; good solution for protection from water ingress; larger connector & anti-wicking ferrule. Recommended for wet environments and on-site length adjustments. To seal the end of light and ensure the waterproof in case of any cutting or extension on site, Insufit technology prevents the water or vapor ingress from the end of the light. DryWire technology applied on the cable eliminates the capillary phenomenon through wires, which secured the long-term reliability in any wading environments. DIY or custom factory assembly.

END EXIT: I2#7A#

END CAP: I20718

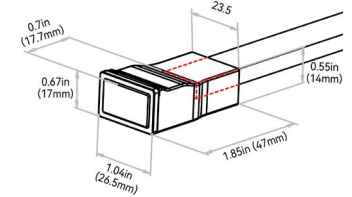
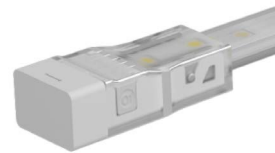
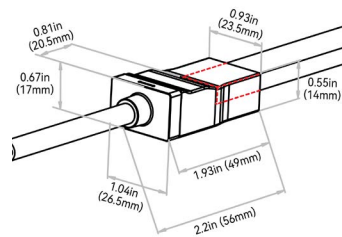

SCREW LOCK CONNECTOR ACCESSORY - IP67

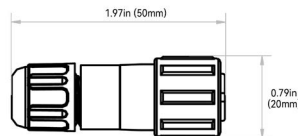

NOTE: The tolerance is ± 0.08 in (2mm).

ANTI-WICKING FERRULE:

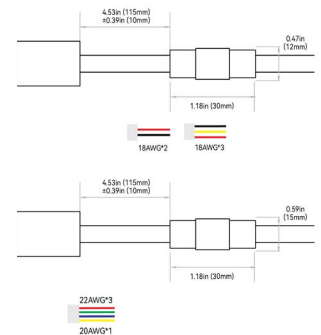

NOTES:

1. The anti-wicking ferrule is located at 4.53in (115mm) (± 0.39 in ± 10 mm) tolerance) from the connector on the cable. For protection against water ingress.
2. The removal of anti-wicking ferrule will void the warranty if any water ingress caused by it.



VIVID LIGHTSTRIP: SILICONE - 24V

Indoor & Outdoor Rated Linear Flex Profile - SPI-Pixel



E

BOTTOM EXIT: I2#7B#

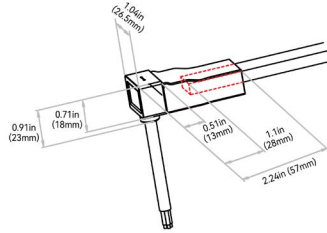
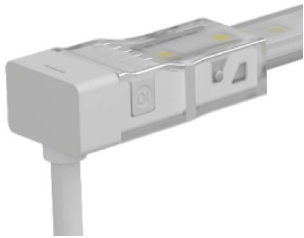

END JUMPER: I2#7E1

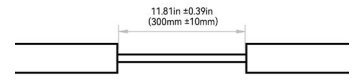

SIDE LEFT EXIT: I2#7C#

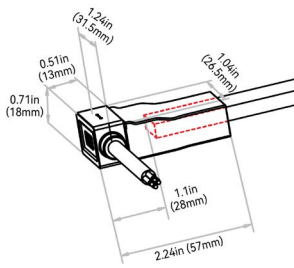
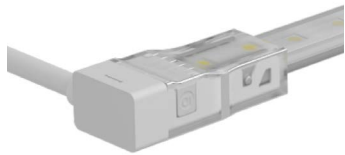

POWER T-FEED: I2#7H#

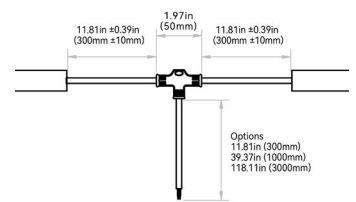

SIDE RIGHT EXIT: I2#7D#

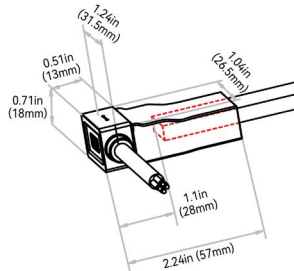
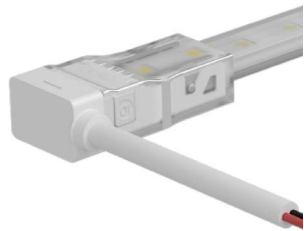

SIDE JUMPER: I2#7G#

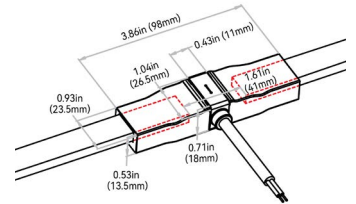

MIDDLE CONNECTOR : I2#7Y#

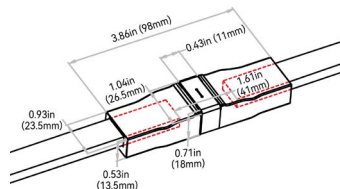

VIVID LIGHTSTRIP: SILICONE - 24V

Indoor & Outdoor Rated Linear Flex Profile - SPI-Pixel



E

SILICONE SEAMLESS CONNECTOR



NOTES:

1. Connector Tolerance ± 0.02 in (0.5mm)
2. Cable diameter: Static, Tunable, RGB, RGBW & SPI Silicone = 0.26in (6.5mm)
3. Do not apply force to the feed cable
4. Ensure Max. Cable Lengths are followed according to wire gage to avoid voltage drop

IP67; seamless; precise low profile dimension; high grade quality silicone & anti-wicking ferrule. Recommended for; wet environments; custom predetermined lengths; high/ low temperatures; increased humidity; direct UV exposure; harsh working conditions & increased handling forces during installation. Precision milling and special glue Silicone liquid injection-moulded workmanship enables an almost consistent size between connectors and lightbody, and the transparent terminal of the connector allows the seamless effects spliced end by end. DryWire technology applied on the cable eliminates the capillary phenomenon through wires, which secured the long-term reliability in outdoor or any wet environments. Custom factory assembly.

END EXIT: I2#2A#

END CAP: I20218

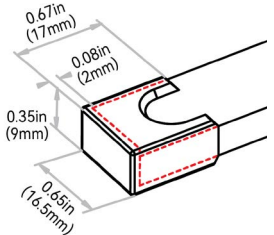
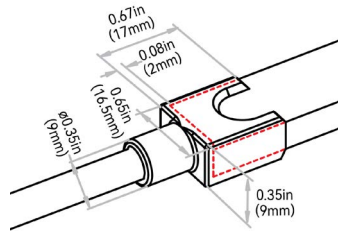

SCREW LOCK CONNECTOR ACCESSORY - IP67

ANTI-WICKING FERRULE:

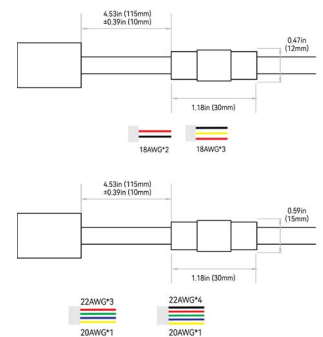
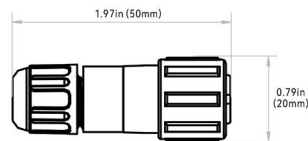

NOTE: The tolerance is ± 0.08 in (2mm).

NOTES:

1. The anti-wicking ferrule is located at 4.53in (115mm) (± 0.39 in [± 10 mm] tolerance) from the connector on the cable. For protection against water ingress.
2. The removal of anti-wicking ferrule will void the warranty if any water ingress caused by it.



VIVID LIGHTSTRIP: SILICONE - 24V

Indoor & Outdoor Rated Linear Flex Profile - SPI-Pixel



E

BOTTOM EXIT: I2#2B#

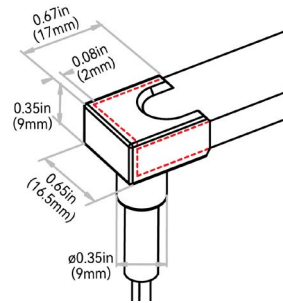

END JUMPER: I2#2E1

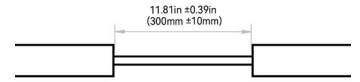

SIDE LEFT EXIT: I2#2C#

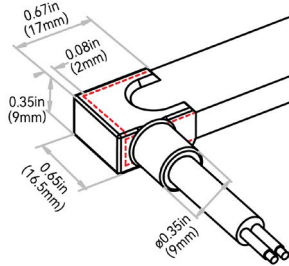

POWER T-FEED: I2#2H#

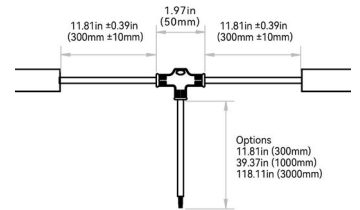

SIDE RIGHT EXIT: I2#2D#

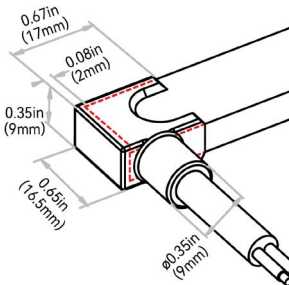

VIVID LIGHTSTRIP: SILICONE - 24V

Indoor & Outdoor Rated Linear Flex Profile - SPI-Pixel



F

MOUNTING PROFILES

MOUNTING PROFILE TYPE	STANDARD LENGTH	PROFILE	COLOR	BEND
A1 = Aluminum Basic	2 = 1.38in (35mm) 3 = 19.68in (500mm) 5 = 39.37in (1000mm) 6 = 78.74in (2000mm)	I = LightStrip	1 = Standard	2 = Top
A12 = Aluminum Transparent Cover	3 = 19.68in (500mm) 5 = 39.37in (1000mm) 6 = 78.74in (2000mm)			
A13 = Aluminum Transparent Cover Compact	3 = 19.68in (500mm) 5 = 39.37in (1000mm) 6 = 78.74in (2000mm)			
A14 = Aluminum Diffused Cover	3 = 19.68in (500mm) 5 = 39.37in (1000mm) 6 = 78.74in (2000mm)			
A15 = Aluminum Diffused Cover Compact	3 = 19.68in (500mm) 5 = 39.37in (1000mm) 6 = 78.74in (2000mm)			
A8 = Aluminum Raceway	3 = 19.68in (500mm) 5 = 39.37in (1000mm) 6 = 78.74in (2000mm)			
A9 = Aluminum Raceway Suspended	3 = 19.68in (500mm) 5 = 39.37in (1000mm) 6 = 78.74in (2000mm)			



VIVID LIGHTSTRIP: SILICONE - 24V

Indoor & Outdoor Rated Linear Flex Profile - SPI-Pixel



F

ALUMINUM PROFILE - BASIC

High-quality 6063 aluminum with thin-wall, light-weight design to fit the fixture tightly. It is deformation and rust resistant, and cost-effective. Please refer to install manual for proper installation practices..

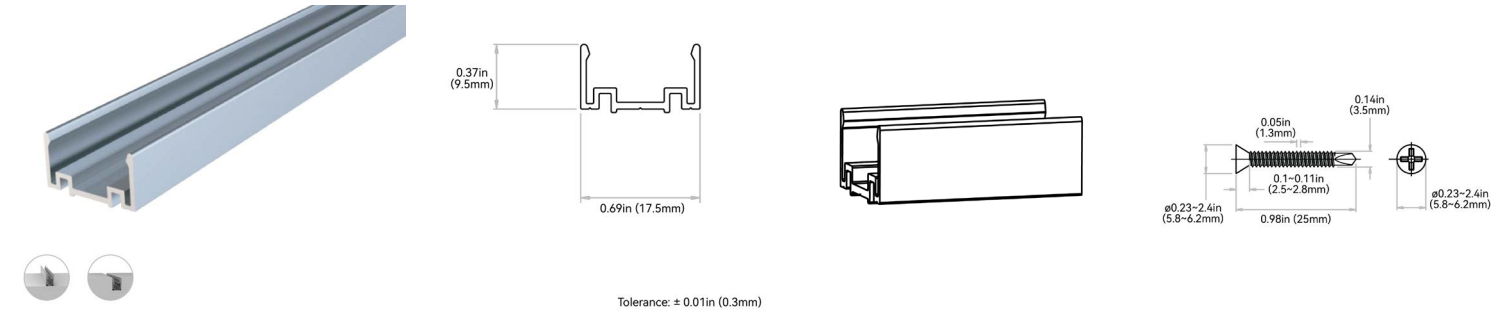

NOTES: 1. 2-L1 refers to two of symmetric L1 in each piece of profile.
2. (N-1)-L2 refers to (N minus one) of symmetric L2 in each piece of profile.
"N" hereby stands for its corresponding "Hole Number" in the below table

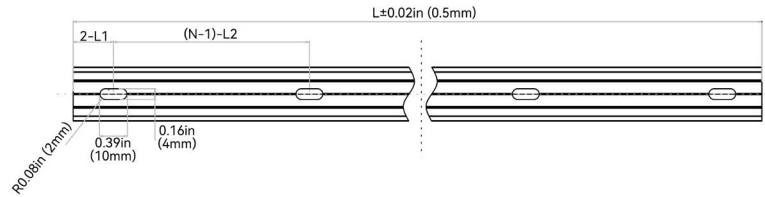

ORDER CODE	LEGACY CODE	STANDARD LENGTH	L1	L2	SLOTTED HOLE	HOLE #
A12112	CL15RAL3C5SD	1.38in (35mm)	0.69in (17.5mm)	N/A	0.16"×0.39in (4"×10mm)	1
A13112	CH15RAL0M5SD	19.68in (500mm)	1.97in (50mm)	7.87in (200mm)	0.16"×0.39in (4"×10mm)	3
A15112	CH15RAL01MSD	39.37in (1000mm)	3.93in (100mm)	7.87in (200mm)	0.16"×0.39in (4"×10mm)	5
A16112	CH15RAL02MSD	78.74in (2000mm)	3.93in (100mm)	7.87in (200mm)	0.16"×0.39in (4"×10mm)	10

ALUMINUM PROFILE - TRANSPARENT COVER

It is composed of 6063 aluminum profile and transparent cover with different light transmittance, and caters for various scenarios with special demands on brightness and light diffusion. The transparent cover effectively decreases the glare, avoids the direct impact on the light surface from an external force, and blocks dust to reduce the influence on the brightness and color, prolonging the light lifespan. Please refer to install manual for proper installation practices.

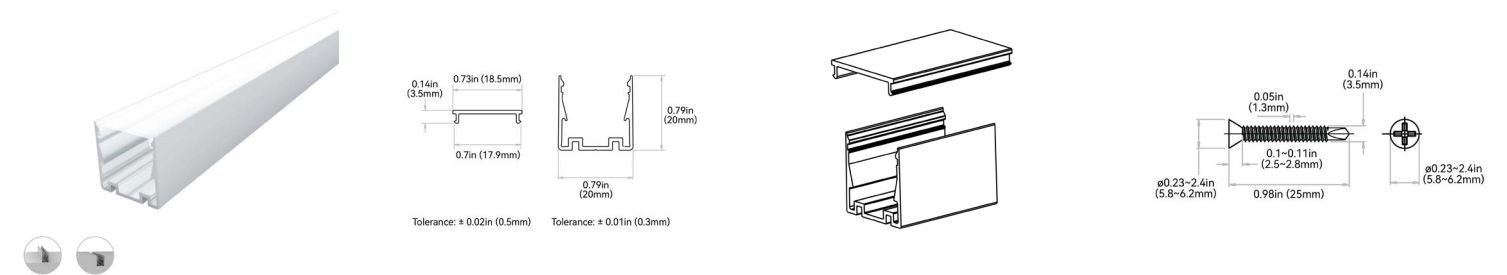

NOTES: 1. 2-L1 refers to two of symmetric L1 in each piece of profile.
2. (N-1)-L2 refers to (N minus one) of symmetric L2 in each piece of profile.
"N" hereby stands for its corresponding "Hole Number" in the below table

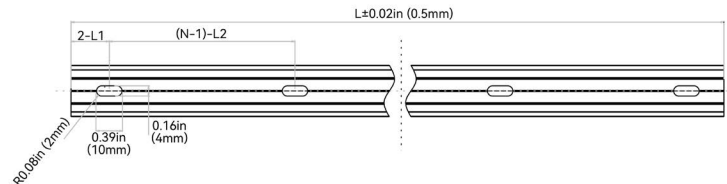

ORDER CODE	LEGACY ORDER CODE	STANDARD LENGTH	L1	L2	SLOTTED HOLE	HOLE #
A123112	CH15CCA0M520	19.68in (500mm)	1.97in (50mm)	7.87in (200mm)	0.16"×0.39in (4"×10mm)	3
A125112	CH15CCA01M20	39.37in (1000mm)	3.93in (100mm)	7.87in (200mm)	0.16"×0.39in (4"×10mm)	5
A126112	CH15CCA02M20	78.74in (2000mm)	3.93in (100mm)	7.87in (200mm)	0.16"×0.39in (4"×10mm)	10



VIVID LIGHTSTRIP: SILICONE - 24V

Indoor & Outdoor Rated Linear Flex Profile - SPI-Pixel



F

ALUMINUM PROFILE - TRANSPARENT COVER - COMPACT

It is composed of 6063 aluminum profile in a compact height and transparent cover with different light transmittance, and caters for various scenarios with special demands on brightness and light diffusion. The transparent cover effectively decreases the glare, avoids the direct impact on the light surface from an external force, and blocks dust to reduce the influence on the brightness and color, prolonging the light lifespan. Please refer to install manual for proper installation practices.

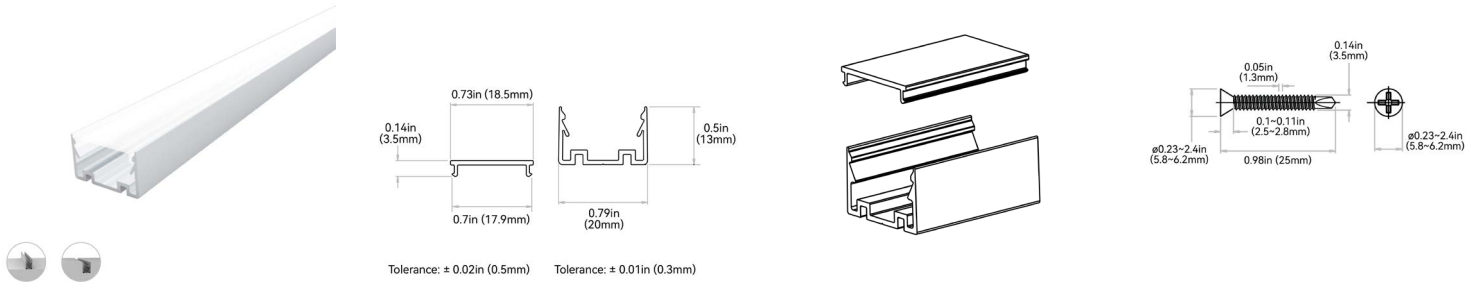

NOTES: 1. 2-L1 refers to two of symmetric L1 in each piece of profile.
2. (N-1)-L2 refers to (N minus one) of symmetric L2 in each piece of profile.
"N" hereby stands for its corresponding "Hole Number" in the below table

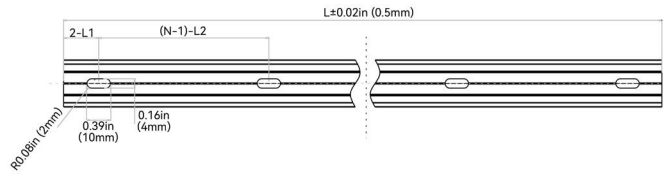

ORDER CODE	LEGACY ORDER CODE	STANDARD LENGTH	L1	L2	SLOTTED HOLE	HOLE #
A133I12	CH15CCA0M513	19.68in (500mm)	1.97in (50mm)	7.87in (200mm)	0.16*0.39in (4*10mm)	3
A135I12	CH15CCA01M13	39.37in (1000mm)	3.93in (100mm)	7.87in (200mm)	0.16*0.39in (4*10mm)	5
A136I12	CH15CCA02M13	78.74in (2000mm)	3.93in (100mm)	7.87in (200mm)	0.16*0.39in (4*10mm)	10

ALUMINUM PROFILE - DIFFUSED COVER

It is composed of 6063 aluminum profile and diffused cover with different light transmittance, and caters for various scenarios with special demands on brightness and light diffusion. The diffused cover effectively decreases the glare, avoids the direct impact on the light surface from an external force, and blocks dust to reduce the influence on the brightness and color, prolonging the light lifespan. Please refer to install manual for proper installation practices.

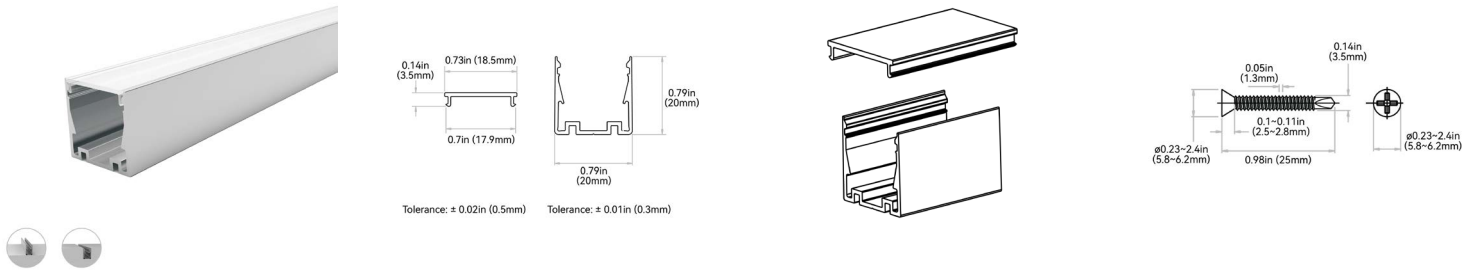

NOTES: 1. 2-L1 refers to two of symmetric L1 in each piece of profile.
2. (N-1)-L2 refers to (N minus one) of symmetric L2 in each piece of profile.
"N" hereby stands for its corresponding "Hole Number" in the below table

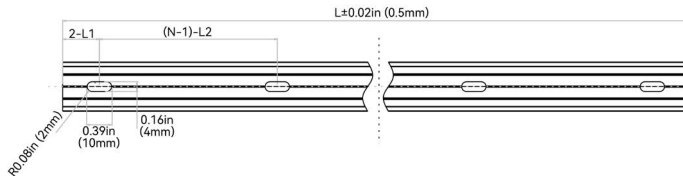

ORDER CODE	LEGACY ORDER CODE	STANDARD LENGTH	L1	L2	SLOTTED HOLE	HOLE #
A143I12	CH15WCA0M520	19.68in (500mm)	1.97in (50mm)	7.87in (200mm)	0.16*0.39in (4*10mm)	3
A145I12	CH15WCA01M20	39.37in (1000mm)	3.93in (100mm)	7.87in (200mm)	0.16*0.39in (4*10mm)	5
A146I12	CH15WCA02M20	78.74in (2000mm)	3.93in (100mm)	7.87in (200mm)	0.16*0.39in (4*10mm)	10



VIVID LIGHTSTRIP: SILICONE - 24V

Indoor & Outdoor Rated Linear Flex Profile - SPI-Pixel



F

ALUMINUM PROFILE - DIFFUSED COVER - COMPACT

It is composed of 6063 aluminum profile in a compact height and diffused cover with different light transmittance, and caters for various scenarios with special demands on brightness and light diffusion. The diffused cover effectively decreases the glare, avoids the direct impact on the light surface from an external force, and blocks dust to reduce the influence on the brightness and color, prolonging the light lifespan. Please refer to install manual for proper installation practices.

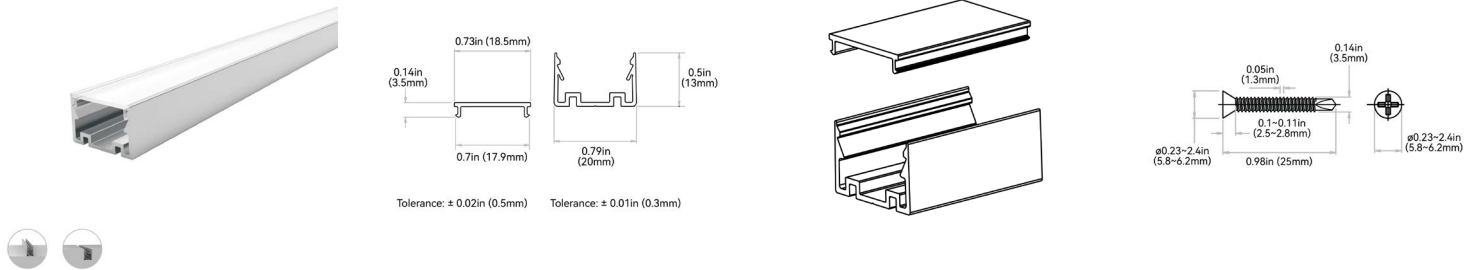

NOTES: 1. 2-L1 refers to two of symmetric L1 in each piece of profile.
2. (N-1)-L2 refers to (N minus one) of symmetric L2 in each piece of profile.
"N" hereby stands for its corresponding "Hole Number" in the below table

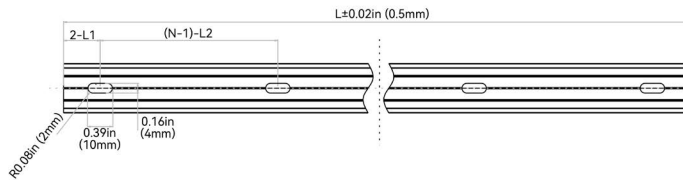

ORDER CODE	LEGACY ORDER CODE	STANDARD LENGTH	L1	L2	SLOTTED HOLE	HOLE #
A153I12	CH15WCA0M513	19.68in (500mm)	1.97in (50mm)	7.87in (200mm)	0.16*0.39in (4*10mm)	3
A155I12	CH15WCA01M13	39.37in (1000mm)	3.93in (100mm)	7.87in (200mm)	0.16*0.39in (4*10mm)	5
A156I12	CH15WCA02M13	78.74in (2000mm)	3.93in (100mm)	7.87in (200mm)	0.16*0.39in (4*10mm)	10

ALUMINUM PROFILE - RACEWAY

High-quality 6063 thin-wall aluminum, light-weight design featuring hidden cables. The raceway space is enough to conceal seamless connectors with bottom feed and the general male/female connectors. It is superb for the facade where tidiness is required and the scenarios that lack of space for wiring. Please refer to install manual for proper installation practices.

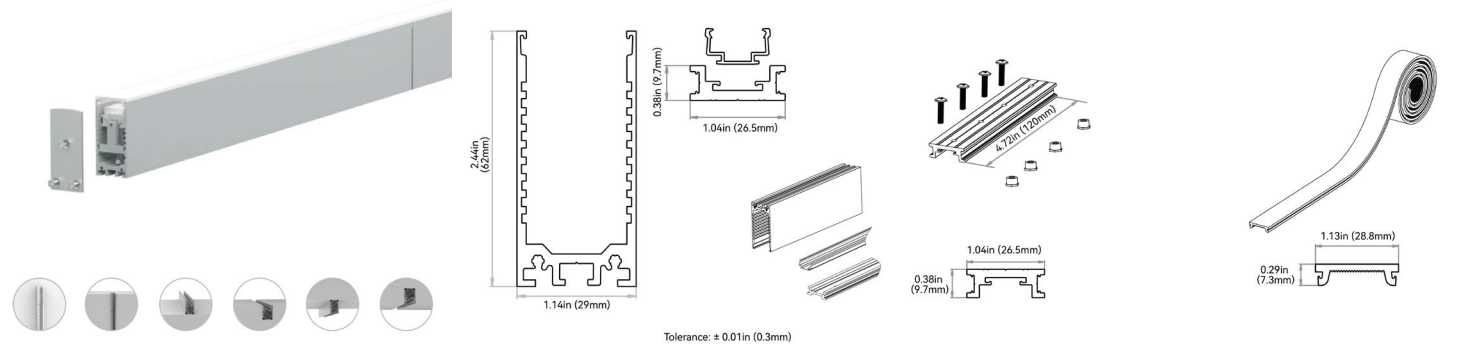

NOTES: 1. 2-L1 refers to two of symmetric L1 in each piece of profile.
2. (N-1)-L2 refers to (N minus one) of symmetric L2 in each piece of profile.
"N" hereby stands for its corresponding "Hole Number" in the below table

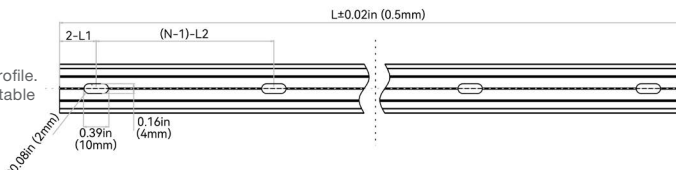

ORDER CODE	LEGACY ORDER CODE	STANDARD LENGTH	L1	L2	SLOTTED HOLE	HOLE #
A83I12	CH15RAL0M5RS	19.68in (500mm)	1.97in (50mm)	7.87in (200mm)	0.18*0.47in (4.5*12mm)	3
A85I12	CH15RAL01MRS	39.37in (1000mm)	3.93in (100mm)	7.87in (200mm)	0.18*0.47in (4.5*12mm)	5
A86I12	CH15RAL02MRS	78.74in (2000mm)	3.93in (100mm)	7.87in (200mm)	0.18*0.47in (4.5*12mm)	10



VIVID LIGHTSTRIP: SILICONE - 24V

Indoor & Outdoor Rated Linear Flex Profile - SPI-Pixel



F

ALUMINUM PROFILE - RACEWAY - SUSPENDED

High-quality 6063 thin-wall aluminum, light-weight design featuring hidden cables and suspended by cables from the ceiling. The raceway space is enough to conceal seamless connectors with bottom feed and the general male/female connectors. It is superb for the facade where tidiness is required and the scenarios that lack of space for wiring. Please refer to install manual for proper installation practices.

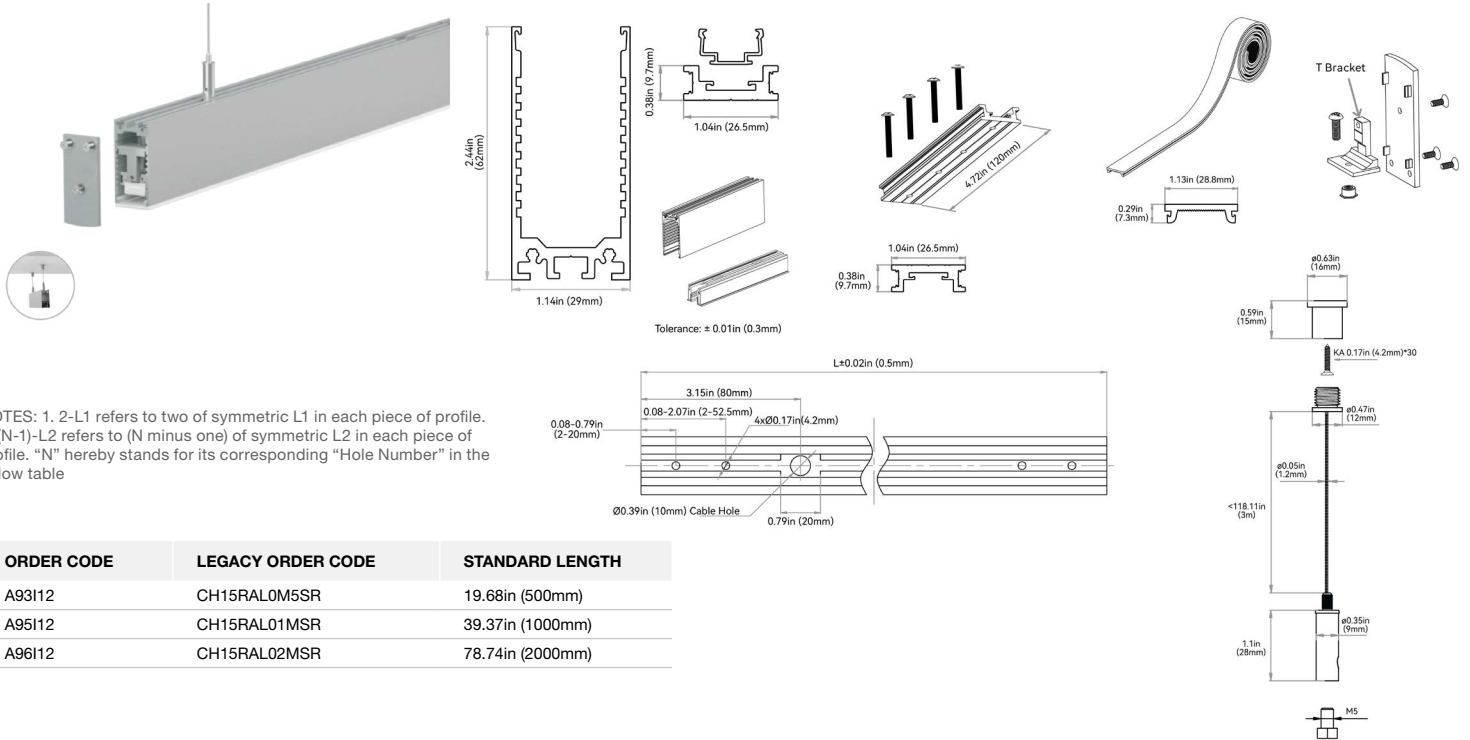

NOTES: 1. 2-L1 refers to two of symmetric L1 in each piece of profile.
 2. (N-1)-L2 refers to (N minus one) of symmetric L2 in each piece of profile. "N" hereby stands for its corresponding "Hole Number" in the below table

ORDER CODE	LEGACY ORDER CODE	STANDARD LENGTH
A93112	CH15RAL0M5SR	19.68in (500mm)
A95112	CH15RAL01MSR	39.37in (1000mm)
A96112	CH15RAL02MSR	78.74in (2000mm)



VIVID LIGHTSTRIP: SILICONE - 24V

Indoor & Outdoor Rated Linear Flex Profile - SPI-Pixel



G

MOUNTING ACCESSORIES

MOUNTING ACCESSORY TYPE	PROFILE
MA1 = Pivot Bracket	O = All Profiles
MA2 = Rotary Bracket	
MA3 = Side Bracket	

PIVOT BRACKET: MA10 | MA00PMB00000

Applicable to all mounting profiles.

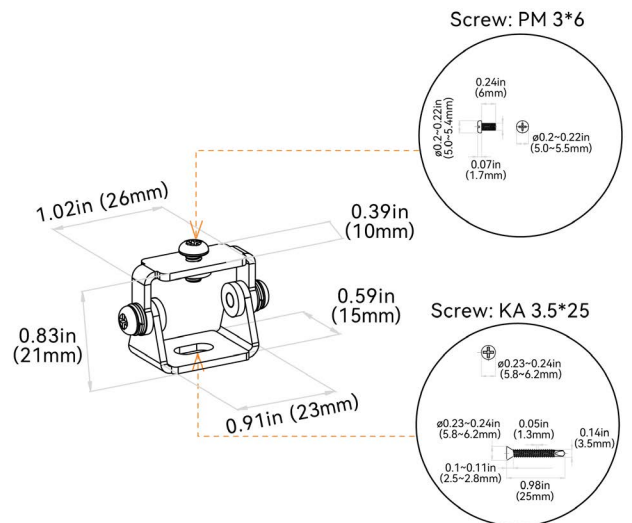
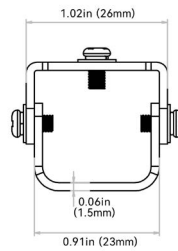

VIVID LIGHTSTRIP: SILICONE - 24V

Indoor & Outdoor Rated Linear Flex Profile - SPI-Pixel



G

ROTARY BRACKET: MA20 | MA00BRL00000

Applicable to all mounting profiles.

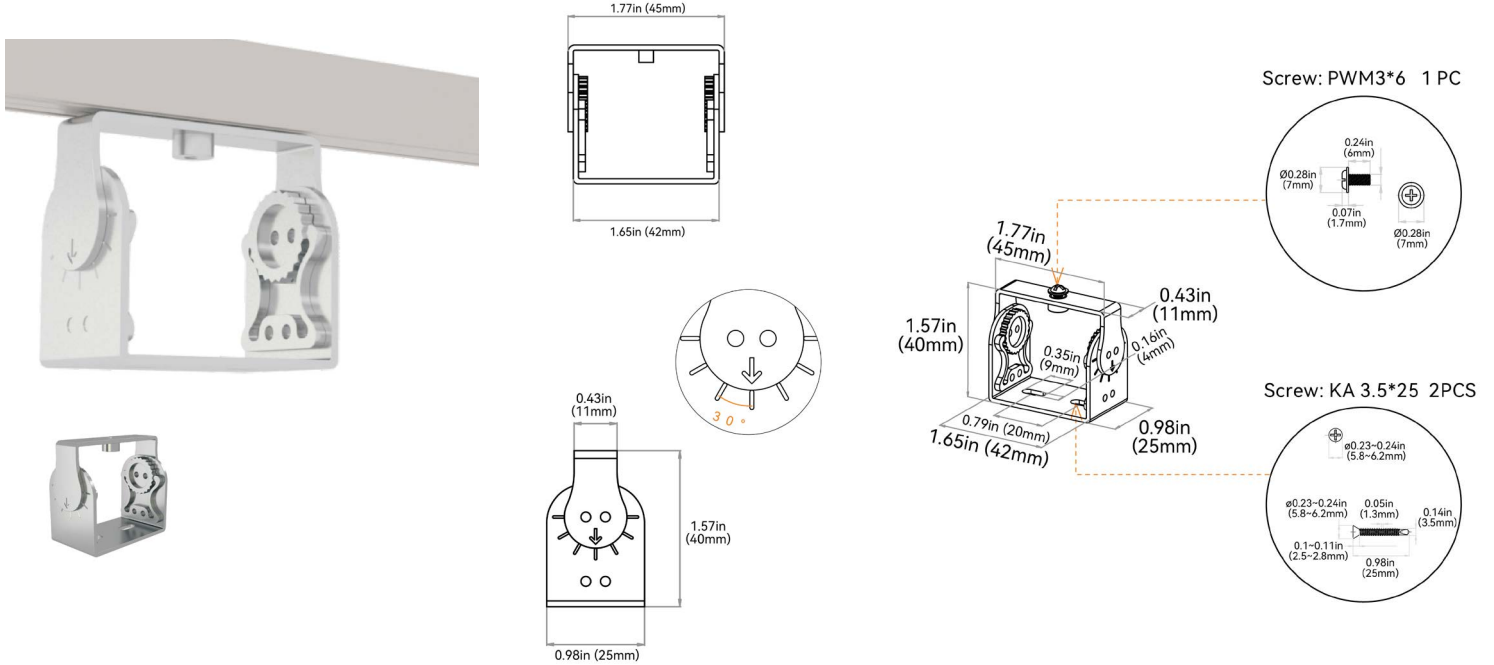

SIDE MOUNTING BRACKET: MA30 | MA00SMB00000

Applicable to all mounting profiles.

