



VIVID LIGHTSTRIP: SILICONE - 24V

Indoor & Outdoor Rated Linear Flex Profile - Tunable White



PROFILE CAPABILITIES

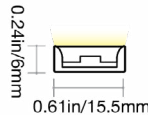

LIGHT SURFACE

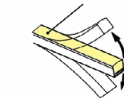

TOP BENDING

MIN BENDING DIAMETER

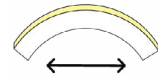

1.97IN (50MM)

CERTIFICATIONS & FEATURES*



TEMPERATURES

AMBIENT OPERATING TEMPERATURE:

-40°F to 131°F (-40°C to 55°C)

AMBIENT INSTALLATION TEMPERATURE:

-40°F to 131°F (-40°C to 55°C)

FIXTURE STORAGE TEMPERATURE:

-40°F to 140°F (-40°C to 60°C)

MAX MOUNTING SURFACE TEMPERATURE:

185°F (85°C)

HUMIDITY (NON-CONDENSING):

0-95%

THERMAL MANAGEMENT:

Free Air Convection

FIXTURE ORDER CODE

E		A				B		
INPUT CONNECTORS	SERIES	MATERIAL	PROFILE	BENDING	JACKET/BASE + LENS COLOR	LED FUNCTION	LED COLOR	CHIP + CRI
See Page 5 to select input connector	V = Vivid	1 = Silicone	I = LightStrip	2 = Top	N = Transparent + Transparent	2 = Tunable White	V = 2200K -6500K	2 = Epistar SMD LED Chip + CRI80

C		D	E		F	G	
POWER	VOLTAGE + CIRCUIT TYPE	ORDER UNIT LENGTH	OUTPUT CONNECTOR		MOUNTING PROFILE	MOUNTING ACCESSORIES	POWER SUPPLIES & CONTROLS:
G = 3.66W/ft (12W/m)	3V = 24V DC CV	F = 3.28in (83.3mm)	See Page 5 to select output connector		See Page 10 to select mounting profiles	See Page 15 to select accessory	By Others By GLLS

*Maximum IP and IK ratings achievable with appropriate accessories, and cable diameter: silicone tunable white = 0.26in (6.5mm).

VIVID LIGHTSTRIP: SILICONE - 24V

Indoor & Outdoor Rated Linear Flex Profile - Tunable White



A

MECHANICAL

ASSEMBLY

Fixtures are carefully assembled using high-quality components to ensure durability and performance. Each unit is built to meet strict specifications, with attention to electrical safety, thermal management, and optical alignment.

OVERALL & CUTTING LENGTHS

Fixtures feature defined overall lengths and specific cutting increments for easy customization. Cutting must be done at marked points to maintain proper function and consistent light output.

JACKET COLOR

The transparent silicone jacket and lens cover provide a sleek look that reveals the internal LEDs, delivering crisp, vibrant light with maximum brightness and color accuracy—ideal for applications where LED visibility enhances visual impact.

BENDING RADIUS

Do not bend smaller than allowed minimum bend diameter, or may cause damage to the light & void warranty.

TESTING

OPTICAL TESTING

TEST	RESULTS
Spectrum Analysis	IES LM 79 (Lumen, CCT, CRI, XY, SDCM, Wavelength)
Photometric Distribution	IES LM 79
Lumen Maintenance & Lifetime	IES LM 84 & IES TM28

ENVIRONMENTAL TESTING

TEST	RESULTS
Salt Water Immersion	IEC60598-1, Saltinity 4%
Salt Spray Test	IEC60068-2-11
Outdoor Exposure	Manufacturer-defined
Flame Resistance	UL94
UV Exposure	ASTMG 154, ISO 4892-3, UVA @ 340nm & 55
IPX8	EN 60598-1: 2015+A1:2018 Clause 9.2.2 & 9.2.8
Temperature Shock(Silicone)	Manufacturer-defined, -40°C - 60°C (typical temperature range)
Constant Temperature	Manufacturer-defined
12mm Needle Flame Test (Silicone)	IEC60695-11-5
650 Glow-wire Test (Silicone)	IEC60695-2-10

OPERATION

LIGHT ENGINE

Tunable White Pulse Width Modulation (PWM) light engines deliver stable, flicker-free light at a fixed brightness. They offer consistent color and reliable performance for long-term applications.

ELECTRICAL

Designed to meet UL, CE, and RoHS standards, they feature overload, overvoltage, and short-circuit protection, along with low EMI and efficient thermal management for safe, reliable operation.

DIMMING

Dimming of 24V PWM fixtures is achieved via the driver or decoder used in the system. Depending on the selected driver/decoder, control options can include 0–10V, DMX, or DALI, enabling smooth, flicker-free dimming while maintaining consistent color and performance. Note: DMX and DALI are supported at the system level, not natively by the fixture.

GENERAL

WARRANTY

Limited 10-Year Warranty against defects in materials and manufacturing. Coverage applies to properly installed and maintained products. Damage from misuse or improper installation is not covered. G.L.L.S. may repair, replace, or issue credit for eligible claims.

LUMEN MAINTENANCE

G.L.L.S. static lighting fixtures are tested to IES LM-84 and projected with IES TM-28 to ensure consistent lumen maintenance. Fixtures are designed to retain at least 70% of their initial brightness (L70) over a 10-year lifespan when properly installed and operated.

CERTIFICATION

Tested to UL2108 Class 2 by Underwriters Laboratory for use in the USA and Canada. Exceeds ANSI C78.377A, CE, and RoHS standards. Must be used under Class 2 ratings to maintain certification.

UL Certificate #: E347880

Report Reference #: E347880-20130503

TEMPERATURE TESTING

TEST	RESULTS
Normal Temperature Test	UL1598 & UL2388 & IEC60598-1 & IEC60598-2-21
Abnormal Operation Test	UL1598 & UL2388 & IEC60598-1 & IEC60598-2-21

DURABILITY TESTING

TEST	RESULTS
Bending Test	Manufacturer-defined, 500 cycles
Tensile Test	Manufacturer-defined, > The weight of light in max.
Twist Test	Manufacturer-defined, >200 cycles
Ball Impact	UL1598 & UL2388 & IEC60598-1 & IEC60598-2-21
IK	IEC62262



VIVID LIGHTSTRIP: SILICONE - 24V

Indoor & Outdoor Rated Linear Flex Profile - Tunable White



B

LED COLORS



2200K-
6500K

FIXTURE SPECIFICATIONS & OPTICAL PARAMETERS

COLOR	LED COUNT	1 CONNECTOR FULL/DYNAMIC*	2 CONNECTORS FULL/DYNAMIC*	UL CLASS 2 MAX RUN**	FIXTURE COLOR TOLERANCE***	WAVELENGTH/ CCT	LED CRI	LED COLOR TOLERANCE	LUMEN COUNT	LEGACY ORDER CODE
2200K;	43 LEDs/ft	49.2ft (15m) /	98.4ft (30m) /	26ft (8m)	3 SDCM	2238 ± 66K;	82-87	2.3SDCM	98lm/ft	SS15GC153WEDWH24DC
6500K;	(144 LEDs/m)	Not Recommended	Not Recommended			6532 ± 340K			(320lm/m);	
2200-6500K									125lm/ft (410lm/m)	

*Run length is based on a voltage drop calculated using a 0.3 m (0.98 ft) cable with silicone seamless connectors, excluding connector length—refer to specifications for details. Max Run: Dynamic = white channels <100%; Full Load = white channels at 100%. For runs over 65.62ft (20m), recommended to limit each to 65.62ft (20m) for easier handling. **For UL Class 2 calculations, GLLS uses a maximum output of 96 W / 96 VA for 24 V circuits, unless otherwise confirmed by the listed driver. All runs are assumed to be single-feed from one Class 2 output. Dual-feeding from separate drivers does not qualify as Class 2 unless the run is electrically split into isolated sections. ***Silicone products maintain ≤3 SDCM within a single production run and <5 SDCM between production runs.



VIVID LIGHTSTRIP: SILICONE - 24V

Indoor & Outdoor Rated Linear Flex Profile - Tunable White



C

POWER & VOLTAGE

COLOR	VOLTAGE + CIRCUIT TYPE	POWER CONSUMPTION
2200-6500K	24V DC CV	3.66W/ft (12W/m)

D

CUTTING INSTRUCTIONS

COLOR	ORDER UNIT (CUTTING UNIT)
2200-6500K	3.28in (83.3mm)

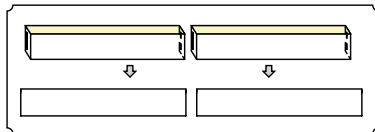
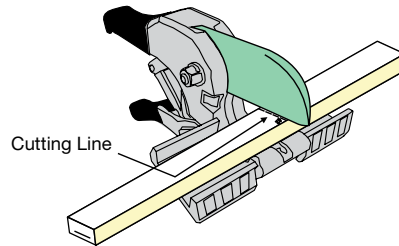
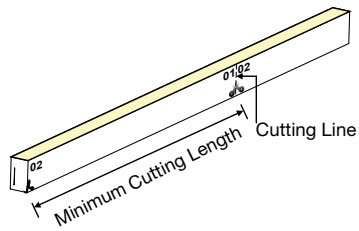

VIVID LIGHTSTRIP: SILICONE - 24V

Indoor & Outdoor Rated Linear Flex Profile - Tunable White



E

COMPATIBLE CONNECTORS

INPUT - 01

PROFILE	BENDING	WIRING	INPUT CONNECTOR TYPE	INPUT ORIENTATION + TYPE	INPUT CABLE LENGTH (LEAD WIRE)
---------	---------	--------	----------------------	--------------------------	--------------------------------

OUTPUT - 02

PROFILE	BENDING	WIRING	OUTPUT CONNECTOR TYPE	OUTPUT ORIENTATION + TYPE	OUTPUT CABLE LENGTH (LEAD WIRE)
I = LightStrip	2 = Top	2 = 3 Wire (Tunable White PWM) 0 = N/A (End Cap)	7 = Snap	A = End Exit B = Bottom Exit C = Side Left Exit D = Side Right Exit E = End Jumper G = Side Jumper H = Power T-Feed Y = Middle Connector I = End Cap	1 = 0.98ft (0.3m) 2 = 3.28ft (1m) 3 = 9.84ft (3m) 4 = 16ft (5m) 5 = 32.81ft (10m) 6 = 49.21ft (15m) 7 = 65.62ft (20m) 8 = N/A
			2 = Silicone Seamless	A = End Exit B = Bottom Exit C = Side Left Exit D = Side Right Exit E = End Jumper H = Power T-Feed I = End Cap	1 = 0.98ft (0.3m) 2 = 3.28ft (1m) 3 = 9.84ft (3m) 4 = 16ft (5m) 5 = 32.81ft (10m) 6 = 49.21ft (15m) 7 = 65.62ft (20m) 8 = N/A

LEGACY CONNECTOR ORDER CODE

XX	15G	1	00	XX	XX	X	XX	XXX	X
PRODUCT TYPE	PROFILE	BENDING	LIGHT EMITTING	FUNCTIONALITY	CONNECTOR TYPE	FIXTURE END	EXIT TYPE	LENGTH	
NA = DIY Accessories FA = Factory Accessories	15G = LightStrip	1 = Top	00 = 15G	2W = Static 3W = Tunable White/SPI-Pixel 4W = RGB 5W = RGBW 0W = For End Cap	SC = Snap SE = Seamless	1 = Input Side 2 = Output Side 0 = Jumpers/T-feeds/ Seamless Bottom/ Seamless End 3 = Input/Output	EN = End BO = Bottom SL = Side Left SR = Side Right EJ = End Jumper BJ = Bottom Jumper TF = Power Feed EC = End Cap	0M3 = 0.98ft (30cm) 01M = 3.28ft (1m) 03M = 9.84ft (3m) 05M = 16ft (5m) 10M = 32.81ft (10m) 000 = For End Cap	P = Power or For End Cap S = Signal & Power



GLLS.COM | 1-888-580-6366

GLLS reserves the right to make any design changes for continuous improvement which will not affect the overall appearance or performance. REV. 20260624

VIVID LIGHTSTRIP: SILICONE - 24V

Indoor & Outdoor Rated Linear Flex Profile - Tunable White



E

SNAP CONNECTOR

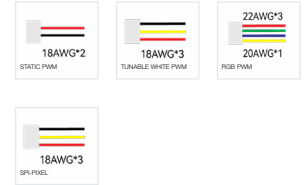

NOTES:

1. Connector Tolerance ± 0.02 in (0.5mm)
2. Cable diameter: Static, Tunable, RGB & SPI Silicone = 0.26in (6.5mm)
3. Do not apply force to the feed cable
4. Ensure Max. Cable Lengths are followed according to wire gage to avoid voltage drop

IP67, tool-less; good solution for protection from water ingress; larger connector & anti-wicking ferrule. Recommended for wet environments and on-site length adjustments. To seal the end of light and ensure the waterproof in case of any cutting or extension on site, Insufit technology prevents the water or vapor ingress from the end of the light. DryWire technology applied on the cable eliminates the capillary phenomenon through wires, which secured the long-term reliability in any wading environments. DIY or custom factory assembly.

END EXIT: I227A#

END CAP: I207I8

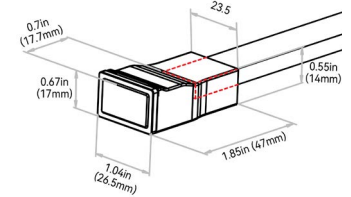
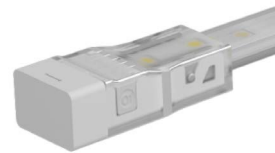
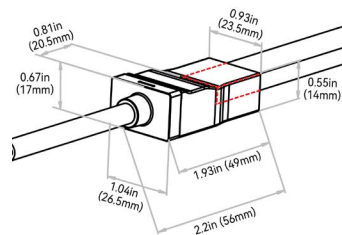

SCREW LOCK CONNECTOR ACCESSORY - IP67

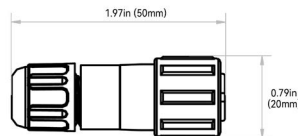

NOTE: The tolerance is ± 0.08 in (2mm).

ANTI-WICKING FERRULE:

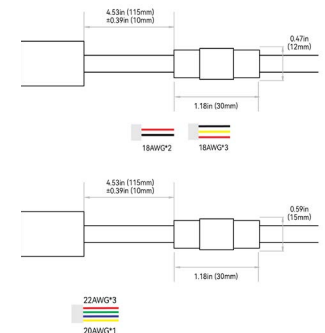

NOTES:

1. The anti-wicking ferrule is located at 4.53in (115mm) (± 0.39 in ± 10 mm) tolerance) from the connector on the cable. For protection against water ingress.
2. The removal of anti-wicking ferrule will void the warranty if any water ingress caused by it.



GLLS.COM | 1-888-580-6366

GLLS reserves the right to make any design changes for continuous improvement which will not affect the overall appearance or performance. REV. 20260624

VIVID LIGHTSTRIP: SILICONE - 24V

Indoor & Outdoor Rated Linear Flex Profile - Tunable White



E

BOTTOM EXIT: I227B#

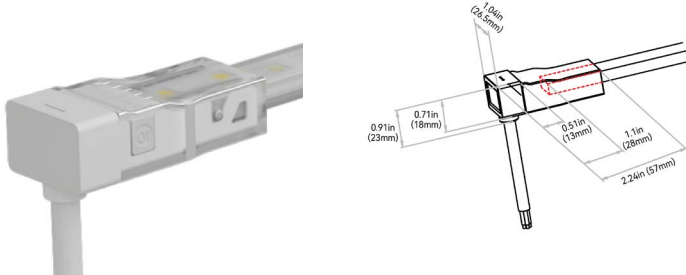

END JUMPER: I227E1

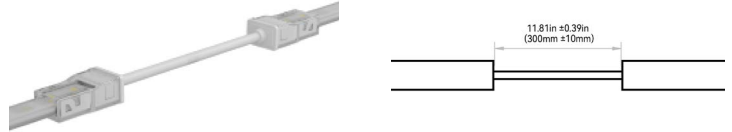

SIDE LEFT EXIT: I227C#

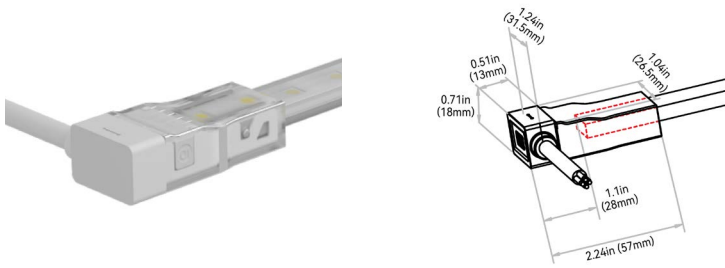

POWER T-FEED: I227H#

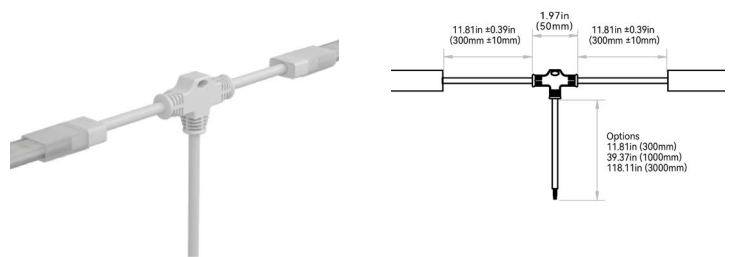

SIDE RIGHT EXIT: I227D#

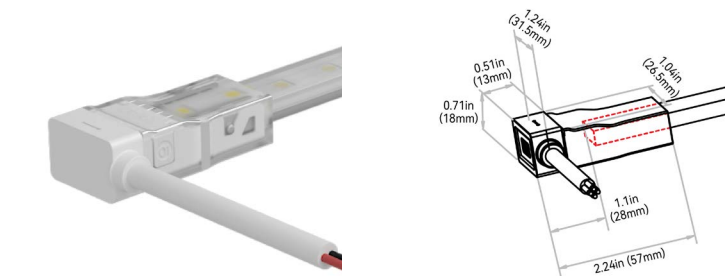

SIDE JUMPER: I227G#

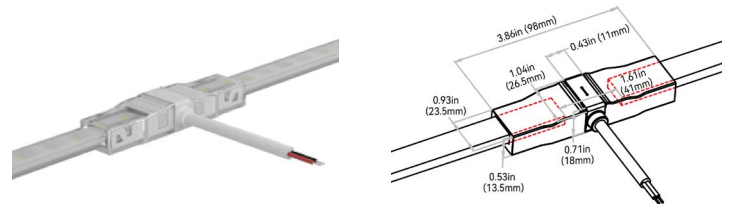

MIDDLE CONNECTOR : I227Y#

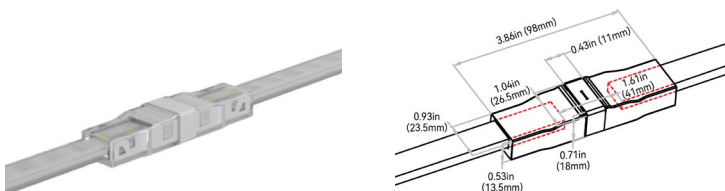

VIVID LIGHTSTRIP: SILICONE - 24V

Indoor & Outdoor Rated Linear Flex Profile - Tunable White



E

SILICONE SEAMLESS CONNECTOR



NOTES:

1. Connector Tolerance ± 0.02 in (0.5mm)
2. Cable diameter: Static, Tunable, RGB, RGBW & SPI Silicone = 0.26in (6.5mm)
3. Do not apply force to the feed cable
4. Ensure Max. Cable Lengths are followed according to wire gage to avoid voltage drop

IP67; seamless; precise low profile dimension; high grade quality silicone & anti-wicking ferrule. Recommended for; wet environments; custom predetermined lengths; high/ low temperatures; increased humidity; direct UV exposure; harsh working conditions & increased handling forces during installation. Precision milling and special glue Silicone liquid injection-moulded workmanship enables an almost consistent size between connectors and lightbody, and the transparent terminal of the connector allows the seamless effects spliced end by end. DryWire technology applied on the cable eliminates the capillary phenomenon through wires, which secured the long-term reliability in outdoor or any wet environments. Custom factory assembly.

END EXIT: I222A#

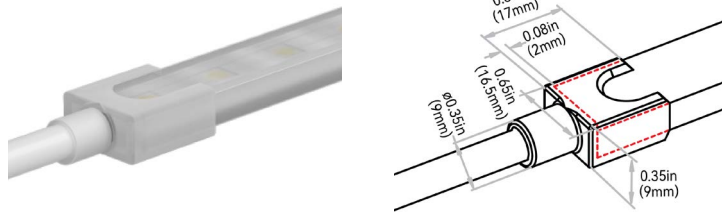

END CAP: I222I8

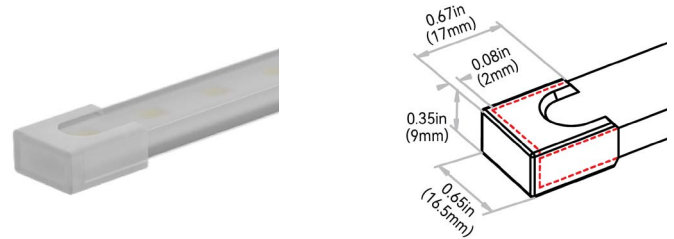

SCREW LOCK CONNECTOR ACCESSORY - IP67

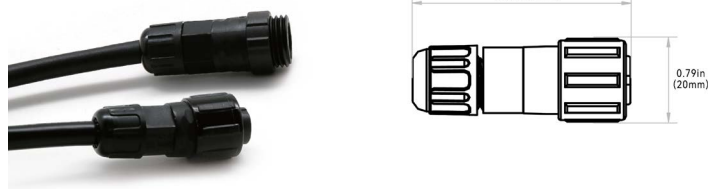

NOTE: The tolerance is ± 0.08 in (2mm).

ANTI-WICKING FERRULE:

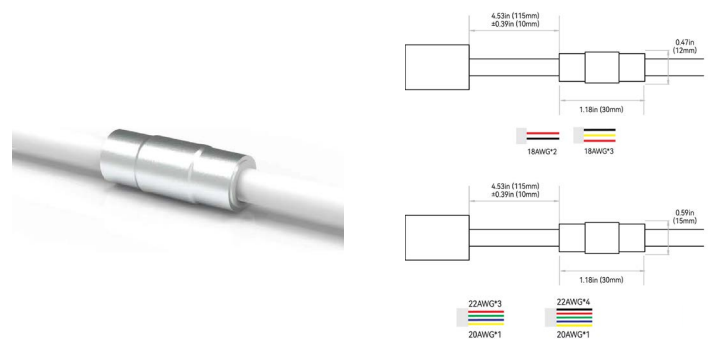

NOTES:

1. The anti-wicking ferrule is located at 4.53in (115mm) (± 0.39 in [± 10 mm] tolerance) from the connector on the cable. For protection against water ingress.
2. The removal of anti-wicking ferrule will void the warranty if any water ingress caused by it.



VIVID LIGHTSTRIP: SILICONE - 24V

Indoor & Outdoor Rated Linear Flex Profile - Tunable White



E

BOTTOM EXIT: I222B#

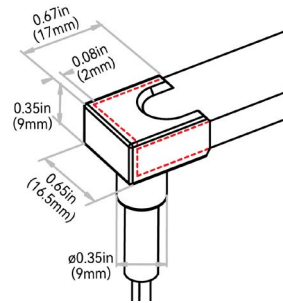

END JUMPER: I222E1

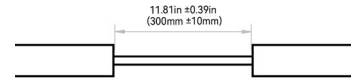

SIDE LEFT EXIT: I222C#

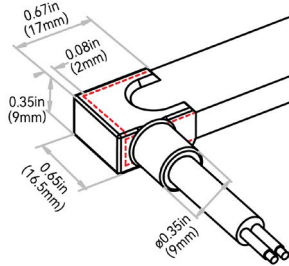

POWER T-FEED: I222H#

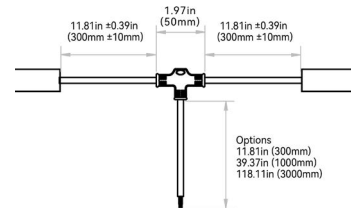

SIDE RIGHT EXIT: I222D#

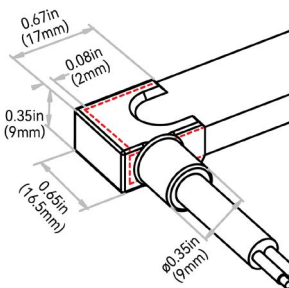

VIVID LIGHTSTRIP: SILICONE - 24V

Indoor & Outdoor Rated Linear Flex Profile - Tunable White



F

MOUNTING PROFILES

MOUNTING PROFILE TYPE	STANDARD LENGTH	PROFILE	COLOR	BEND
A1 = Aluminum Basic	2 = 1.38in (35mm) 3 = 19.68in (500mm) 5 = 39.37in (1000mm) 6 = 78.74in (2000mm)	I = LightStrip	1 = Standard	2 = Top
A12 = Aluminum Transparent Cover	3 = 19.68in (500mm) 5 = 39.37in (1000mm) 6 = 78.74in (2000mm)			
A13 = Aluminum Transparent Cover Compact	3 = 19.68in (500mm) 5 = 39.37in (1000mm) 6 = 78.74in (2000mm)			
A14 = Aluminum Diffused Cover	3 = 19.68in (500mm) 5 = 39.37in (1000mm) 6 = 78.74in (2000mm)			
A15 = Aluminum Diffused Cover Compact	3 = 19.68in (500mm) 5 = 39.37in (1000mm) 6 = 78.74in (2000mm)			
A8 = Aluminum Raceway	3 = 19.68in (500mm) 5 = 39.37in (1000mm) 6 = 78.74in (2000mm)			
A9 = Aluminum Raceway Suspended	3 = 19.68in (500mm) 5 = 39.37in (1000mm) 6 = 78.74in (2000mm)			



VIVID LIGHTSTRIP: SILICONE - 24V

Indoor & Outdoor Rated Linear Flex Profile - Tunable White



F

ALUMINUM PROFILE - BASIC

High-quality 6063 aluminum with thin-wall, light-weight design to fit the fixture tightly. It is deformation and rust resistant, and cost-effective. Please refer to install manual for proper installation practices..

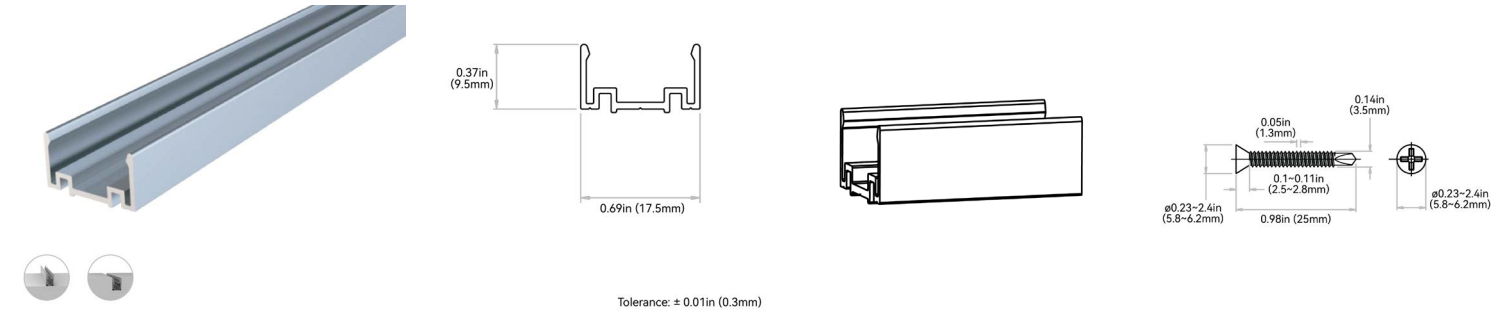

NOTES: 1. 2-L1 refers to two of symmetric L1 in each piece of profile.
2. (N-1)-L2 refers to (N minus one) of symmetric L2 in each piece of profile.
"N" hereby stands for its corresponding "Hole Number" in the below table

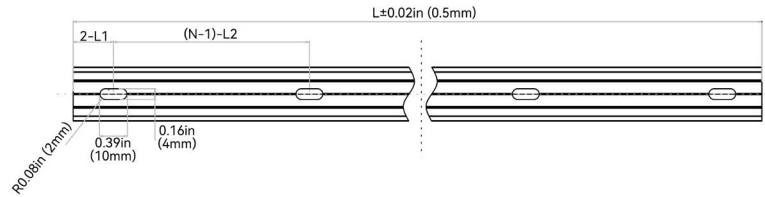

ORDER CODE	LEGACY CODE	STANDARD LENGTH	L1	L2	SLOTTED HOLE	HOLE #
A12112	CL15RAL3C5SD	1.38in (35mm)	0.69in (17.5mm)	N/A	0.16"×0.39in (4"×10mm)	1
A13112	CH15RAL0M5SD	19.68in (500mm)	1.97in (50mm)	7.87in (200mm)	0.16"×0.39in (4"×10mm)	3
A15112	CH15RAL01MSD	39.37in (1000mm)	3.93in (100mm)	7.87in (200mm)	0.16"×0.39in (4"×10mm)	5
A16112	CH15RAL02MSD	78.74in (2000mm)	3.93in (100mm)	7.87in (200mm)	0.16"×0.39in (4"×10mm)	10

ALUMINUM PROFILE - TRANSPARENT COVER

It is composed of 6063 aluminum profile and transparent cover with different light transmittance, and caters for various scenarios with special demands on brightness and light diffusion. The transparent cover effectively decreases the glare, avoids the direct impact on the light surface from an external force, and blocks dust to reduce the influence on the brightness and color, prolonging the light lifespan. Please refer to install manual for proper installation practices.

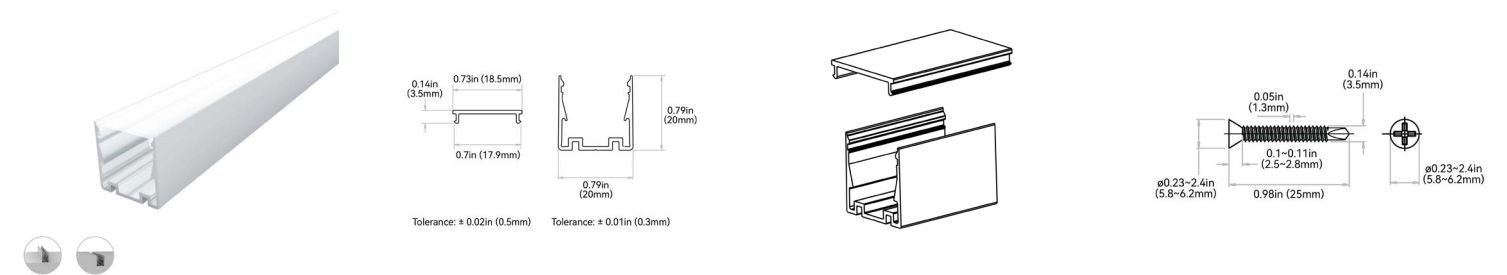

NOTES: 1. 2-L1 refers to two of symmetric L1 in each piece of profile.
2. (N-1)-L2 refers to (N minus one) of symmetric L2 in each piece of profile.
"N" hereby stands for its corresponding "Hole Number" in the below table

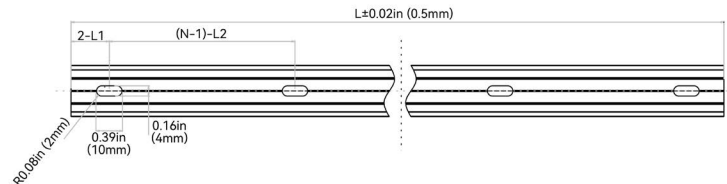

ORDER CODE	LEGACY ORDER CODE	STANDARD LENGTH	L1	L2	SLOTTED HOLE	HOLE #
A123112	CH15CCA0M520	19.68in (500mm)	1.97in (50mm)	7.87in (200mm)	0.16"×0.39in (4"×10mm)	3
A125112	CH15CCA01M20	39.37in (1000mm)	3.93in (100mm)	7.87in (200mm)	0.16"×0.39in (4"×10mm)	5
A126112	CH15CCA02M20	78.74in (2000mm)	3.93in (100mm)	7.87in (200mm)	0.16"×0.39in (4"×10mm)	10



VIVID LIGHTSTRIP: SILICONE - 24V

Indoor & Outdoor Rated Linear Flex Profile - Tunable White



F

ALUMINUM PROFILE - TRANSPARENT COVER - COMPACT

It is composed of 6063 aluminum profile in a compact height and transparent cover with different light transmittance, and caters for various scenarios with special demands on brightness and light diffusion. The transparent cover effectively decreases the glare, avoids the direct impact on the light surface from an external force, and blocks dust to reduce the influence on the brightness and color, prolonging the light lifespan. Please refer to install manual for proper installation practices.

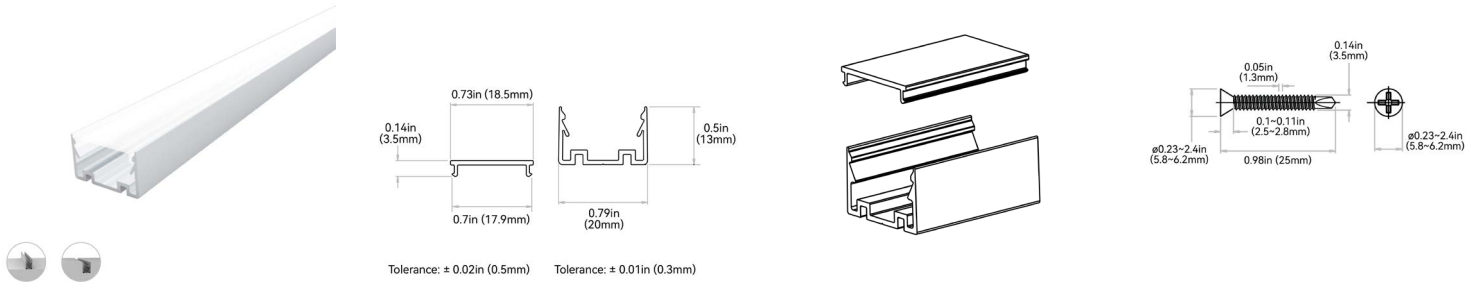

NOTES: 1. 2-L1 refers to two of symmetric L1 in each piece of profile.
 2. (N-1)-L2 refers to (N minus one) of symmetric L2 in each piece of profile.
 "N" hereby stands for its corresponding "Hole Number" in the below table

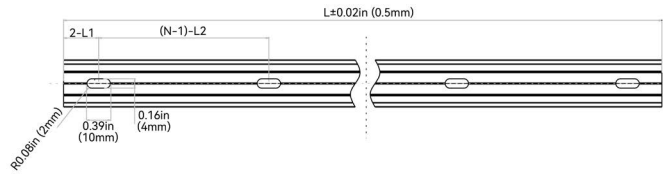

ORDER CODE	LEGACY ORDER CODE	STANDARD LENGTH	L1	L2	SLOTTED HOLE	HOLE #
A133I12	CH15CCA0M513	19.68in (500mm)	1.97in (50mm)	7.87in (200mm)	0.16*0.39in (4*10mm)	3
A135I12	CH15CCA01M13	39.37in (1000mm)	3.93in (100mm)	7.87in (200mm)	0.16*0.39in (4*10mm)	5
A136I12	CH15CCA02M13	78.74in (2000mm)	3.93in (100mm)	7.87in (200mm)	0.16*0.39in (4*10mm)	10

ALUMINUM PROFILE - DIFFUSED COVER

It is composed of 6063 aluminum profile and diffused cover with different light transmittance, and caters for various scenarios with special demands on brightness and light diffusion. The diffused cover effectively decreases the glare, avoids the direct impact on the light surface from an external force, and blocks dust to reduce the influence on the brightness and color, prolonging the light lifespan. Please refer to install manual for proper installation practices.

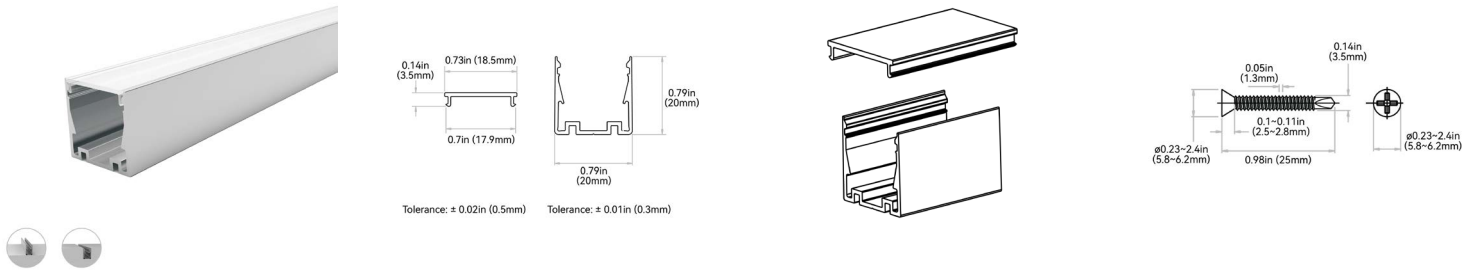

NOTES: 1. 2-L1 refers to two of symmetric L1 in each piece of profile.
 2. (N-1)-L2 refers to (N minus one) of symmetric L2 in each piece of profile.
 "N" hereby stands for its corresponding "Hole Number" in the below table

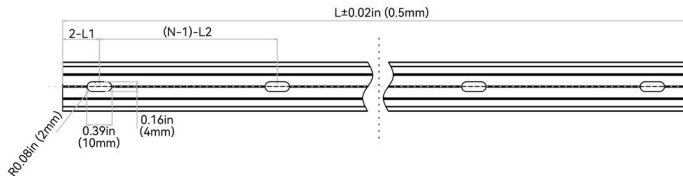

ORDER CODE	LEGACY ORDER CODE	STANDARD LENGTH	L1	L2	SLOTTED HOLE	HOLE #
A143I12	CH15WCA0M520	19.68in (500mm)	1.97in (50mm)	7.87in (200mm)	0.16*0.39in (4*10mm)	3
A145I12	CH15WCA01M20	39.37in (1000mm)	3.93in (100mm)	7.87in (200mm)	0.16*0.39in (4*10mm)	5
A146I12	CH15WCA02M20	78.74in (2000mm)	3.93in (100mm)	7.87in (200mm)	0.16*0.39in (4*10mm)	10



VIVID LIGHTSTRIP: SILICONE - 24V

Indoor & Outdoor Rated Linear Flex Profile - Tunable White



F

ALUMINUM PROFILE - DIFFUSED COVER - COMPACT

It is composed of 6063 aluminum profile in a compact height and diffused cover with different light transmittance, and caters for various scenarios with special demands on brightness and light diffusion. The diffused cover effectively decreases the glare, avoids the direct impact on the light surface from an external force, and blocks dust to reduce the influence on the brightness and color, prolonging the light lifespan. Please refer to install manual for proper installation practices.

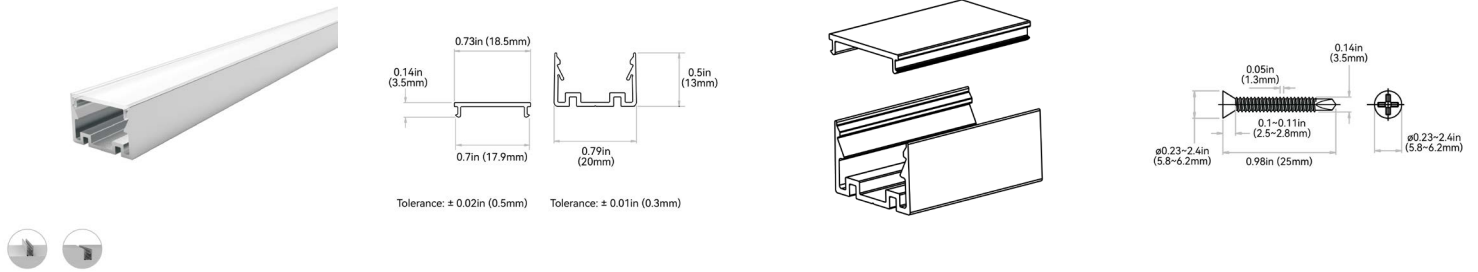

NOTES: 1. 2-L1 refers to two of symmetric L1 in each piece of profile.
2. (N-1)-L2 refers to (N minus one) of symmetric L2 in each piece of profile.
"N" hereby stands for its corresponding "Hole Number" in the below table

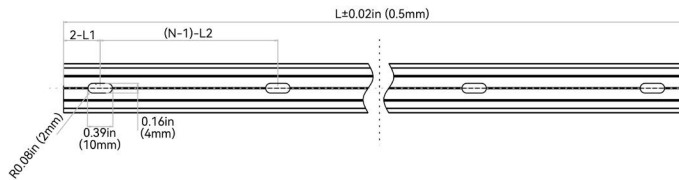

ORDER CODE	LEGACY ORDER CODE	STANDARD LENGTH	L1	L2	SLOTTED HOLE	HOLE #
A15312	CH15WCA0M513	19.68in (500mm)	1.97in (50mm)	7.87in (200mm)	0.16*0.39in (4*10mm)	3
A15512	CH15WCA01M13	39.37in (1000mm)	3.93in (100mm)	7.87in (200mm)	0.16*0.39in (4*10mm)	5
A15612	CH15WCA02M13	78.74in (2000mm)	3.93in (100mm)	7.87in (200mm)	0.16*0.39in (4*10mm)	10

ALUMINUM PROFILE - RACEWAY

High-quality 6063 thin-wall aluminum, light-weight design featuring hidden cables. The raceway space is enough to conceal seamless connectors with bottom feed and the general male/female connectors. It is superb for the facade where tidiness is required and the scenarios that lack of space for wiring. Please refer to install manual for proper installation practices.

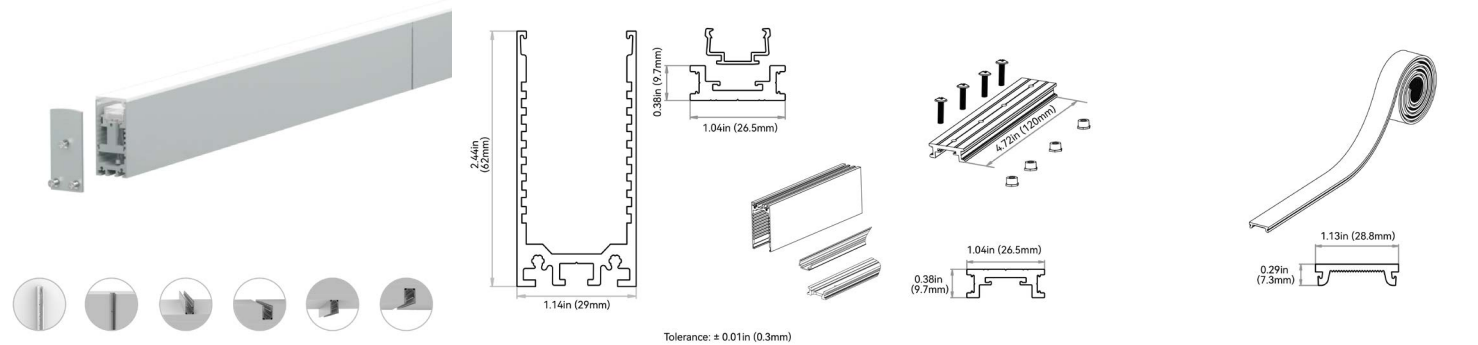

NOTES: 1. 2-L1 refers to two of symmetric L1 in each piece of profile.
2. (N-1)-L2 refers to (N minus one) of symmetric L2 in each piece of profile.
"N" hereby stands for its corresponding "Hole Number" in the below table

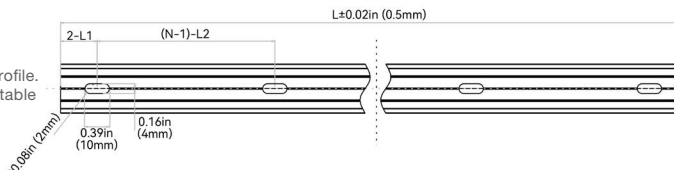

ORDER CODE	LEGACY ORDER CODE	STANDARD LENGTH	L1	L2	SLOTTED HOLE	HOLE #
A8312	CH15RAL0M5RS	19.68in (500mm)	1.97in (50mm)	7.87in (200mm)	0.18*0.47in (4.5*12mm)	3
A8512	CH15RAL01MRS	39.37in (1000mm)	3.93in (100mm)	7.87in (200mm)	0.18*0.47in (4.5*12mm)	5
A8612	CH15RAL02MRS	78.74in (2000mm)	3.93in (100mm)	7.87in (200mm)	0.18*0.47in (4.5*12mm)	10



VIVID LIGHTSTRIP: SILICONE - 24V

Indoor & Outdoor Rated Linear Flex Profile - Tunable White



G

MOUNTING ACCESSORIES

MOUNTING ACCESSORY TYPE	PROFILE
MA1 = Pivot Bracket	O = All Profiles
MA2 = Rotary Bracket	
MA3 = Side Bracket	

PIVOT BRACKET: MA10 | MA00PMB00000

Applicable to all mounting profiles.

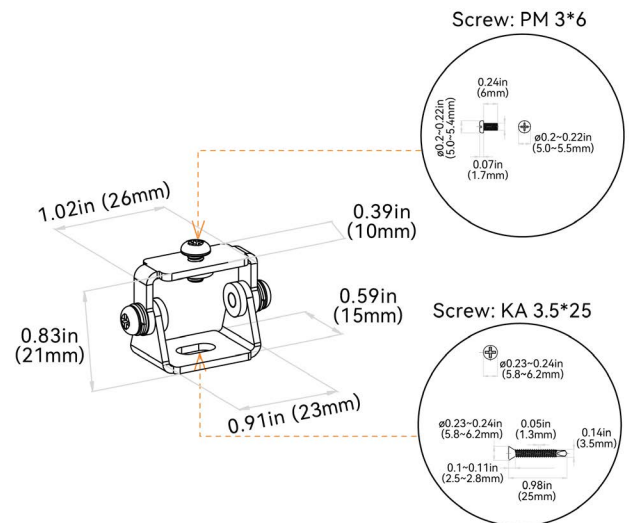
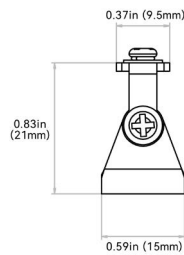
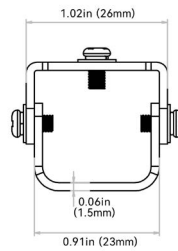

VIVID LIGHTSTRIP: SILICONE - 24V

Indoor & Outdoor Rated Linear Flex Profile - Tunable White



G

ROTARY BRACKET: MA20 | MA00BRL00000

Applicable to all mounting profiles.

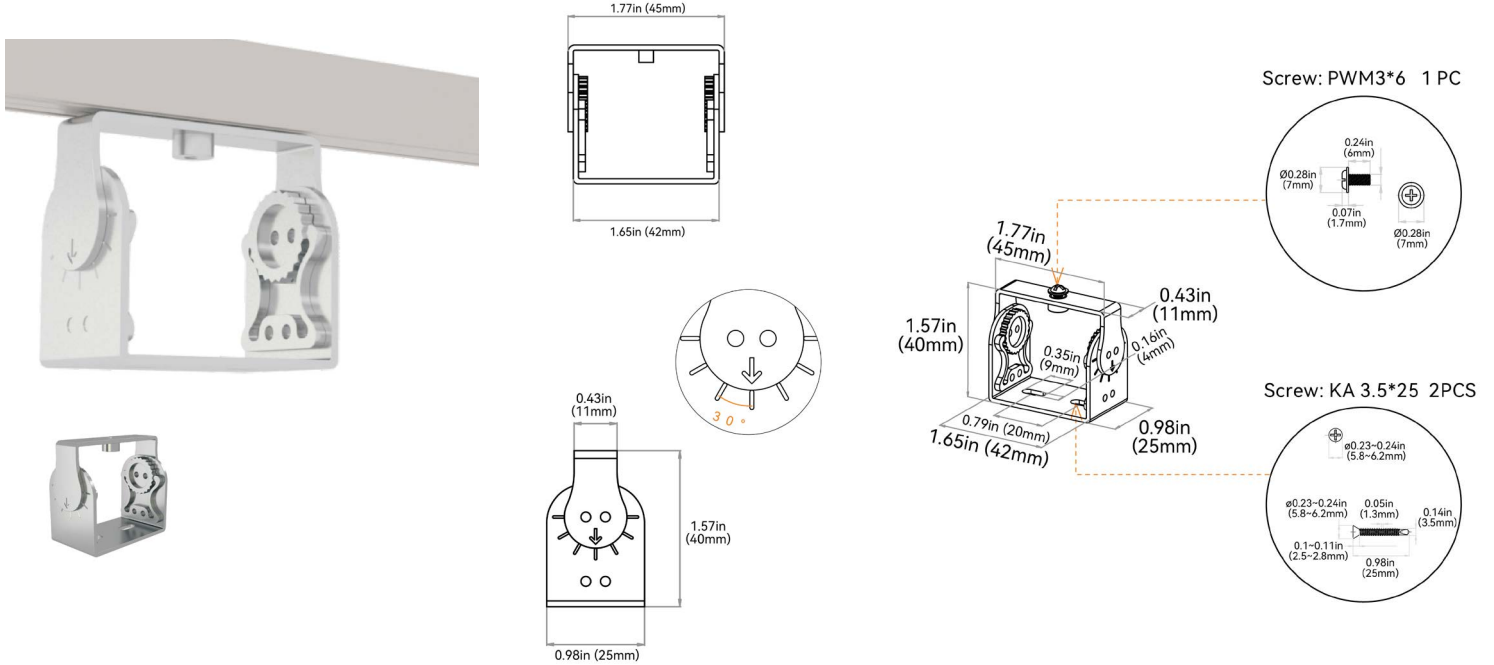

SIDE MOUNTING BRACKET: MA30 | MA00SMB00000

Applicable to all mounting profiles.

