

SYNER JET^{PRO}

USER MANUAL

PRODUCT	Electrosurgical System
MODEL	SYNERJET PRO™



TABLE OF CONTENTS

Introduction	Copyright	3
	Intellectual Property Rights / Purpose of Use	3
	Caution / Contraindications	4,5
	Precautions for Treatment	6
	Restrictions for Use / Side Effects	7
	General Precautions	8
	Precautions for Prevention of Safety Accidents / Interactions / Precautions for Infections and Side Effects	9
	Definitions of Symbols and Labels	10
	<hr/>	
1. Product Overview and Components	1.1 Overview of SYNERJET PRO™	12
	1.2 Product Performance	13
	1.3 Product Components and Functions	14
<hr/>		
2. General Safety	2.1 Precautions before Use	27
	2.2 Power Connection	28
<hr/>		
3. How to Use	3.1 Preparations before Use	29
	3.2 Instructions for Use and Handling	29
	3.3 Using the Screen	39
<hr/>		
4. Maintenance and Storage	4.1 Storing and Maintaining the Product	58
	4.2 Precautions for Storage	58
	4.3 Preparations for Transportation	59
	4.4 Cleaning	59
<hr/>		
5. Troubleshooting	5.1 Steps to Take in Emergency Situations	60
	5.2 Troubleshooting by Symptom	61
	5.3 Cybersecurity response method	62
<hr/>		
6. Warranty	6.1 Overview	62
	6.2 Warranty coverage	62
	6.3 Exceptions to the warranty	63
<hr/>		
Warranty Certificate	Warranty Certificate	55

Copyright

Copyright © Hironic Co., Ltd. (henceforth "Hironic")

The product referred to herein is protected by the Industrial Property Act and other domestic and international intellectual property rights, including copyrights. Unauthorized duplication or use of this product without prior written consent by Hironic is prohibited.

Intellectual Property Rights

SYNERJET PRO™ related intellectual property rights referred to herein include all of the patent, trademark and design rights applied for or registered in Korea and other countries. All of the rights related to this product are protected by the relevant intellectual property rights.

The product referred to herein is protected by Hironic Co., Ltd.'s intellectual property rights, including the patent rights and their patent family, as well as the trademark rights and design rights. Unauthorized use of this product is an infringement of Hironic Co., Ltd.'s intellectual property rights and may be subject to civil and/or criminal penalties.

Purpose of Use

SYNERJET PRO™ is a medical combined device with 'Electrosurgical System, general purpose', 'Injector system, jet, needleless' and 'Stimulator system, transcutaneous electrical'.

(1) Electrosurgical System, general purpose (Handpiece - PS)

Used in the removal and destruction of skin lesions and coagulation of tissue.

(2) Injector system, jet, needleless (Handpiece - SJ)

Indicated for delivery of various medications to the body.

(3) Stimulator system, transcutaneous electrical (Handpiece - SJ)

Indicated for skin stimulation, pain relief, reduction of muscle spasms



Caution

Manipulation, control, and procedural implementation of the equipment in a way that is inconsistent with the instructions for normal use stated in the manual can cause a serious danger.

Caution

- (1) Use of this device for purposes other than its intended purpose is prohibited, and it should not be used by anyone other than an authorized user (doctor).
- (2) Never use on eyes, wounds, or other areas where serious damage to human tissue may occur.
- (3) If a device malfunction occurs, do not disassemble or manipulate the equipment. Attach a malfunction sign to the device and contact the manufacturer.
- (4) Equipment and tips must not be forged or used. Service must be performed by a designated professional technician and only standard accessories must be used.
- (5) If the Hand piece is dropped, impacted, or bumped, serious damage may occur, so be careful. We are not responsible for damage caused by careless use, such as dropping, abuse, or misuse.
- (6) Before use, be sure to read the user manual to understand how to use the device, and always check whether it is operating properly before use.
- (7) Research results on use with body-embedded medical electronic devices and life-support electronic devices have revealed. Therefore, do not use this product and other devices together.
- (8) Do not disassemble or modify the device on your own.
- (9) Since the device generally generates high-frequency voltage and current, do not locate devices sensitive to electric or magnetic fields nearby.
- (10) When the device is operating, do not use it in parallel with an induction heater.
- (11) Be sure to keep the area where the device will be located electrically insulated.
- (12) The user must be able to prevent contact between the patient's skin during treatment, so wear medical gloves before using the device on the skin to avoid the risk of burns to the user and the patient.
- (13) Before use, check the patient's skin condition and the cleanliness of equipment, Hand pieces, consumables, etc., and remove foreign substances such as alcohol or Please use a soft cloth to wipe it.
- (14) If the humidity is too high, blisters may form on the device parts and surfaces, which can cause damage to important parts. Therefore, maintain appropriate humidity and do not locate the product outdoors where there are large temperature changes.
- (15) Always be careful of fire and do not place flammable gases or ignitable substances in the treatment area.
- (16) Do not move the device when it is operating.
- (17) Even a minor impact to the main body may cause serious damage to the machine, so be especially careful when moving it.
- (18) Do not use in environments with rapid temperature or pressure changes.

Contraindications

- (1) If the patient falls under any of the following conditions, use of SYNERJET PRO™ is prohibited.
 - Patients with open wounds at the treatment site
 - Patients with severe acne or follicular acne in the treatment area
 - Patients with metal stents or implants in the treatment area
 - Patients with implants with built-in electrical devices
 - Patients with systemic or localized skin diseases that may affect the wound healing process

- (2) Before use, the doctor must check whether the patient falls under the following conditions and determine whether to perform the procedure through sufficient prior consultation.
 - Patients with acute illness
 - Patients using electronic medical devices equipped with an electrocardiogram system
 - Patients with cardiovascular disease or other physical diseases
 - Patients currently suffering from active acute or chronic diseases, including skin diseases
 - Patients with high blood pressure, diabetes, cancer
 - Those who have dermatological lesions or sensory abnormalities in the treatment area
 - Those with keloid or hypertrophic scar constitution
 - Those who continuously use steroid drugs or undergo anti-immunotherapy
 - Patients taking medications with high sensitivity to sunlight or those with sensitivity to sunlight
 - People with infections such as AIDS and HIV, people with autoimmune diseases, people with experience of immunosuppression or taking immunosuppressants
 - Patients with diseases related to blood coagulation disorders such as hemostasis or blood clots
 - Have taken or plan to take antiplatelet agents, anticoagulants, thrombolytic agents, or anti-inflammatory agents within 2 weeks of starting treatment case
 - Those taking aspirin or drugs containing aspirin ingredients
 - Pregnant women, breastfeeding women and infants (For women who are expected to become pregnant, the decision is made after taking a pregnancy test before the procedure and prior consultation with a specialist)
 - People who are menstruating
 - Those whose skin has been tanned by sunlight, those who need to tan with an artificial tanning machine, within a week (7 days) before or after treatment, those who may be exposed to strong sunlight
 - Those with skin diseases such as herpes simplex, wounds, psoriasis, eczema, and rash in the treatment area
 - Those who have experience with dermabrasion or liposuction in the treatment area

Precautions for Treatment

- (1) Always monitor the overall device and patient for any abnormalities.
- (2) If an abnormality is found in the device or patient, take appropriate measures such as stopping the device operation while maintaining a safe condition for the patient.
- (3) Before using the device, be sure to check if there is flammable gas around it.
- (4) Please use in a place where air circulation is possible, and do not place the device in a corner or on a shelf.
- (5) Be careful when performing treatment on curved areas of the skin.
- (6) Do not operate by pointing it at your eyes during treatment. If an injury occurs inside the eye, stop the device immediately and seek immediate medical attention.
- (7) If severe redness or pain occurs in the area where energy is irradiated during use, check for abnormalities and adjust the energy or appropriate action must be taken.

1) General-purpose electrosurgical device

- (1) During the procedure, use the irradiation unit in close contact with the skin horizontally.
- (2) Do not use in enclosed spaces.

2) Injector, Jet, Mechanical-Powered

- (1) Only designated nozzles must be used.
- (2) SJ nozzles are sterilized and packaged, and you must check the packaging condition and expiration date before use. If the packaging is damaged or the expiration date has expired, do not use and replace with a new nozzle.
- (3) To prevent secondary contamination, SJ nozzles must be opened immediately before use.
- (4) If foreign substances are found in the product before use, do not use it.
- (5) Do not use on wounded or blood vessel areas.
- (6) Do not reuse the chemical liquid inside the injector, including the syringe.
- (7) Once the SJ nozzle has been opened, it must be discarded even if it has not been used.
- (8) Since the SJ nozzle is disposable, it must be disposed of according to the designated method after use.
- (9) When using, be careful when spraying over one area of the skin as side effects may occur due to accumulation.
- (10) When using, be careful to avoid skin injection site infection and exposure to blood, and be careful to prevent the injection solution and syringe from becoming infected.
- (11) Excessive pain, tenderness, swelling, abnormal skin sensation, and infection symptoms may occur at the injection site. Patients should be notified in advance so that they are aware of these facts, and caution should be exercised during the procedure.

3) Low frequency electric stimulator

- (1) When in contact with the body, use as close as possible.
- (2) Be sure to use the EP tip in conjunction with the SJ nozzle.

Restrictions for Use

There are no age restrictions when applying this device to patients, but depending on the user's problem, the patient's health status must be determined to determine whether to use it and the appropriate results.

Side Effects

When performing a procedure with this medical device, the following symptoms may occur, so it must be used with caution.

- Erythema, tenderness, edema, swelling, pain, bruising, numbness, blisters, ulcers, skin burns, itchiness, hyperpigmentation, hypopigmentation, irregular skin contour, dull sensation, indentation, necrosis (apoptosis), hardness. Skin, stiffness, nodules, changes in skin laxity, nerve paralysis symptoms, asymmetry (caused by unbalanced treatment or unbalanced anatomy of the treatment area)
- It may cause swelling, redness and discomfort, but this is only temporary and will not last longer than a week.
- Rarely, temporary small skin-colored papules, such as white heads, may be visible for several weeks (1-2 months).
- If the main nerve is affected, temporary muscle weakness may occur.
- If sensory nerves are affected, sensation may be temporarily dulled.
- There may be temporary pain and numbness or stinging in the hands and feet.
- If a burn occurs on the skin surface during treatment, stop treatment immediately and proceed with treatment for the burn first.

General Precautions

- 1) Before operating the equipment, read and understand the user manual and then accept relevant professional training.
- 2) Users must take appropriate measures and always be prepared for risks.
- 3) This product is protected from disposal/modification.
- 4) You can handle and repair the product based on what you want.
- 5) Do not use anything outside of the supplied parts.
- 6) Do not apply independent or additional shock to the main body.
- 7) Connect the power cord and device to ensure secure integration.
- 8) If you want to use the device without using it, check whether the device is working and please use it.
- 9) Turn on the switch before using the device, and turn off the power switch when not in use.
- 10) Avoid direct sunlight and can be located on the same site as equipment that generates high heat.
- 11) In a well-ventilated area where air can circulate to prevent damage from itching, dust, and pressure. Please use it.
- 12) Check the grounding condition and do not touch the power plug with your hands.
- 13) In the event of a cybersecurity-related accident, do not disassemble or disassemble the equipment, but attach a separate mark to the equipment and please contact the manufacturer.

Precautions for Prevention of Safety Accidents

- 1) The heat generated when using electrodes can be a source of ignition in the presence of flammable substances, so completely remove these substances. It must be evaporated before use.
- 2) No flammable materials should be placed near this equipment.
- 3) Use in locations where there is no adverse effect from atmospheric pressure, temperature, humidity, ventilation, dust, air containing salt, sulfur, or liquids such as water.
- 4) Avoid use in places where chemicals are stored, where gases are generated, or where flammable substances are generated.
- 5) Use according to the power frequency, voltage, and allowable current (or power consumption) used.
- 6) Carry out periodic inspection and maintenance.
- 7) A fire extinguisher must be located in the area where the equipment is used.
- 8) Do not place near flammable substances such as anesthetics or solvents that can easily ignite.
- 9) locate at least 10cm away from the wall to allow for ventilation.
- 10) When using, do not use shots in duplicate locations.
- 11) This device should not be located outdoors where there are large temperature changes.
- 12) If severe redness or pain occurs in the area where energy is irradiated during use, check for abnormalities and adjust the energy or appropriate action must be taken.

Interactions

- (1) There have been no research results regarding use with body-embedded medical electronic devices or life-support electronic devices, so do not use this product with other devices.
- (2) Portable and mobile communication devices are prohibited from being used during procedures as they may affect medical electrical equipment.











Precautions for Infections and Side Effects

Please be careful as infection or side effects may occur if you do not follow the instructions below.







- (1) The nozzle is disposable, so please discard it after use.
- (2) Never reuse medicines, cosmetics, ampoules, etc. in the nozzle and syringe as this may cause serious infections and side effects.

Definitions of Symbols and Labels

Symbols that can be found on the components, accessories, or the packaging that come with the system are as follows:

Symbol / Label	Description
	Indicates a potential threat that may result in death or serious injuries to the practitioner if the instruction is neglected.
	Provides important information on using the system.
	Indicates the address of the product manufacturer.
	Indicates the manufacture date of the product.
	Indicates a type BF applied part; this is in accordance with the regulation for protection against electric shocks (IEC 60417-5333).
	This mark indicates that the product cannot be disposed of as general waste, according to the Directive on Waste Electrical and Electronic Equipment (Directive 2002/96/EC and EN50419). The product should be collected separately and recycled. For more information on disposal, contact Hironic Co., Ltd.
ON / OFF	Indicates turning the product power on/off switch.
	Serial number.
	Indicates the possibility of electromagnetic interference.
	Sterilized using ethylene oxide.
	Batch code.
	Indicates that instructions in the user manual must be followed.

Introduction

Symbol / Label	Description
	Single Use only
	Use by Date
	Do not use if package is damaged
	Keep away from sunlight
	Keep dry
	Unique Device Identifier (UDI)
	Medical Device

- ※ It is recommended that the descriptions of signs and indications displayed on the screen be thoroughly read and understood before using the system.

1. Product Overview and Components

1.1 Overview of SYNERJET PRO™

This device is an instrument used for tissue coagulation by means of high-frequency current. It consists of the main unit, Hand pieces (SJ, PS Handpiece), foot switch, other accessories and power cable.

This device is designed on the basis of the principle that as high-frequency energy (RF) flows, the heat generated from the load or contact resistance causes the coagulation of cellular tissues.

1.1.1 Electric specifications

- A) Rated voltage / frequency: 100-240 V~ / 50-60 Hz
- B) Power consumption: 700 VA
- C) Display part: 12.1 TFT LCD

1.1.2 Form and degree of protection for rating

- A) Form and degree of protection against electric shock: Class 1 device, Type BF device

1.1.3. Safety devices

No.	Device	Description
1	Equipment fixing device	There is a device to fix the wheels to prevent physical shock and shaking
2	Foot switch	Prevent abnormal operation by setting the user to operate by pressing the footswitch directly
3	STANDBY /READY button	After the user sets each hand piece, set it to operate by pressing it directly to prevent abnormal operation (not output in standby state, output only in ready state)
4	USB / Wi-Fi	- When upgrading S/W and F/W, Md5Hash authentication method is used. - WiFi uses WPA2 + AES, WPA + AES, WPA + TKIP/AES, WPA + TKIP, and WEP authentication methods.
5	Power Protection for inputs	Since the circuit protective fuse is attached to the power input, power is cut off when power exceeding the rated power is applied. (Fuse capacity: 250V, 3.15A)
6	Emergency stop button	In case of an emergency, press the button on the front of the product to turn off the power and stop the product operation.
7	Prevent simultaneous operation of hand pieces	SJ and PS hand pieces are designed to prevent simultaneous operation, preventing abnormal operation.
8	Prevent hand piece operation errors	When connecting a different type of hand piece to the hand piece connection terminal, terminal connection errors are notified by the LED warning light and alarm sound on the main unit to prevent abnormal operation.

1.1.4. Mechanical specifications

- A) Main Body [W × D × H]: 653 x 482 x 1311 mm
- B) SJ Hand piece [W × D × H]: 36 x 36 x 162 mm
- C) PS Hand piece [W × D × H]: 46 x 50 x 180 mm
- D) SJ Nozzle – SJN 130, SJN 180, SJN 230 [W × D × H]: 48 x 37 x 45 mm
- E) EP Tip
 - EPT 5 [W × D × H]: 34 x 34 x 29 mm
 - EPT 10 [W × D × H]: 34 x 34 x 34 mm
 - EPT 15 [W × D × H]: 34 x 34 x 39 mm
- F) PS Tip [W × D × H]: 32.3 x 32.6 x 20.7 mm
- G) PS Brush Tip [W × D × H]: 32.3 x 32.6 x 28.6 mm
- H) Foot Switch [W × D × H]: 148 x 160 x 140 mm
- I) Hand piece Cable Holder: 300 mm
- J) EP Tip Holder [W × D × H]: 93 x 93 x 47 mm
- K) Cup [W × D × H]: 83 x 83 x 94 mm
- L) Power Cable: 3 m

1.2 Product performance

The product specifications are as below:

No.	HP	Type	Item	Details
1	SJ HP	Nozzle	Power	100 ~ 200 V (10 Step)
2			Speed	1~25 Hz (1 Step)
3			Volume	1.0 ~ 3.0 Lv (0.1 Lv step)
4			Nozzle-based spray amount	Within 0.1 ml ±30%
5			Nozzle chemical spray hole size	SJN 130: 0.13 mm ±10% SJN 180: 0.18 mm ±10% SJN 230: 0.23 mm ±10%
6	EP Tip		Outer Power	1 ~ 4 Lv (1Lv step)
7			Operating Frequency	760 Hz
8	PS HP	PS Tip	Operating Frequency	41 kHz
9			Outer Power	1 ~ 5 Lv (1Lv step)
10		PS Brush Tip	Operating Frequency	41 kHz
11	Outer Power		1 ~ 4 Lv (1Lv step)	

1.3 Product Components and Functions

1.3.1 Product configuration

SYNERJET PRO™ consists of the following components

No.	Component	Quantity	Note
1	Main unit	1 EA	-
2	SJ Hand piece	1 EA	-
3	PS Hand piece	1 EA	Option
4	Hand piece Cable Holder	2 EA	-
5	Power Cable	1 EA	-
6	Foot Switch	1 EA	-
7	EP Tip Holder	1 EA	-
8	Cup	1 EA	-

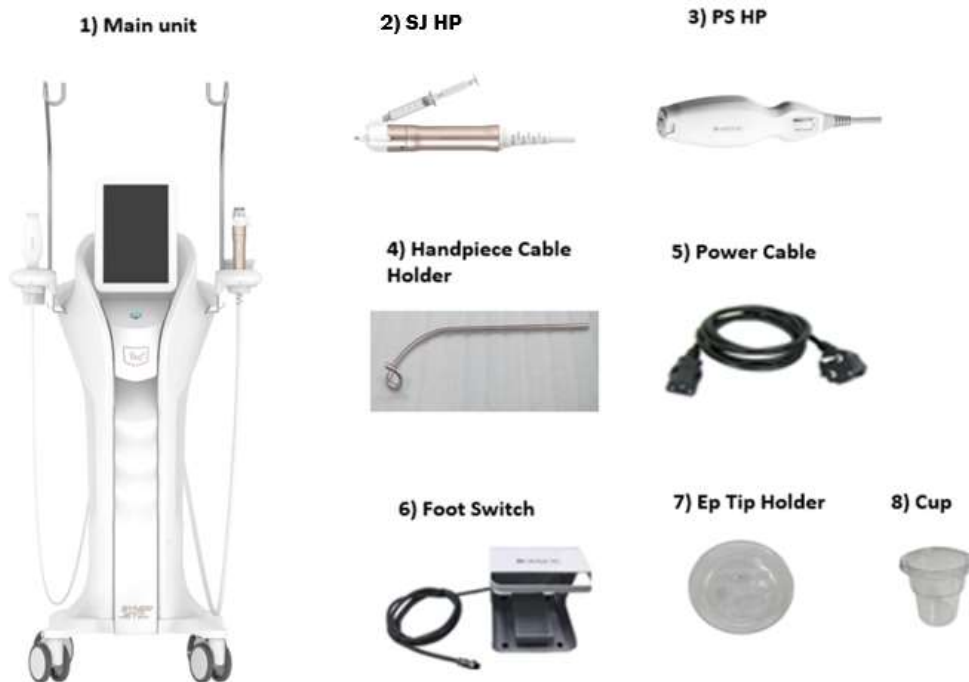

1.3.2 Additional components

No.	Component	Quantity	Note
9	SJ Nozzle – SJN 130, SJN 180, SJN 230	1 SET	Option
10	EP Tip - EPT 5, EPT 10, EPT 15	1 SET	Option
11	PS Tip	1 SET	Option
12	PS Brush tip	1 SET	Option
13	User Manual	1 EA	-

9) SJ Nozzle



10) EP Tip



11) PS Tip



12) PS Brush Tip



13) User Manual



1.3.3 Names and functions of components

1.3.3.1 Main body—Front view

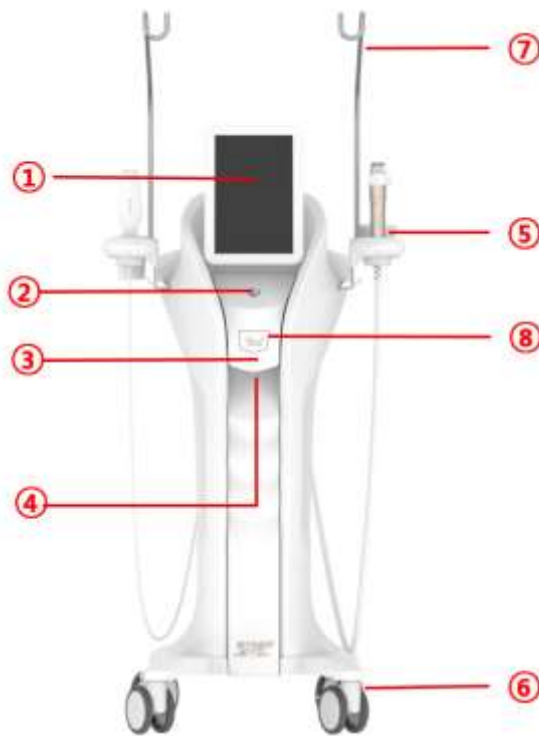

No.	Item name	Description
1	Touch Display	A touch display shows the device status so that a user can set up energy values, etc.
2	Power switch	A switch used to control equipment operation
3	Handle(Front)	Front handle for carrying the device.
4	LED	This indicates the product's operation status in LED color.
5	Hand piece holder	This holder is exclusively for a Hand piece. When a Hand piece is attached, the main unit sensor recognizes it automatically.
6	Caster	There are 4 casters used to transport the device. As each has a locking unit, these can be fixed while the device is used.
7	Hand piece Cable Holder	Holder for holding the Hand piece cable
8	RFID TAG	Prevent counterfeit nozzle information and counterfeit products through RFID TAG

1.3.3.2 Main Body-Rear view

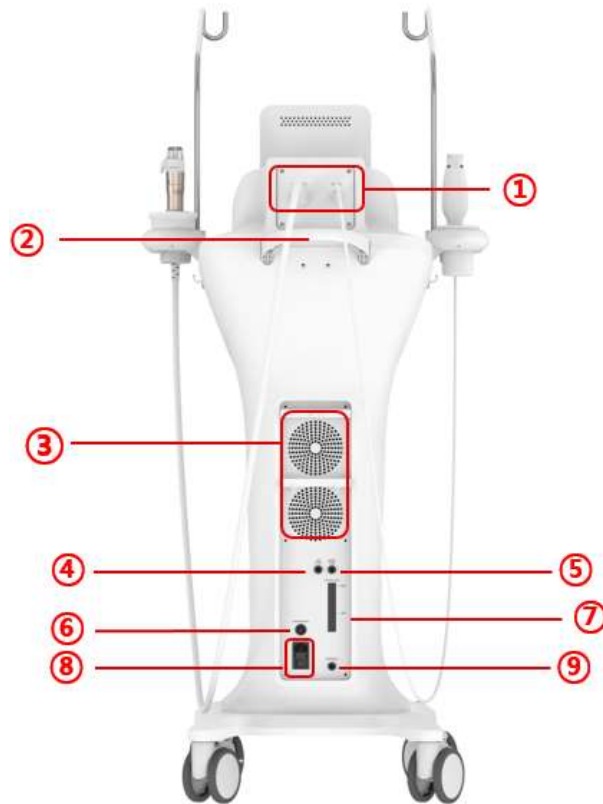

No.	Item name	Description
1	Hand piece connector	Port to connect the Hand piece to the main unit
2	Handle for transportation	Handle for carrying the device
3	Discharger	Heat inside the system is discharged through this hole to the outside.
4	Air Tube	Tube connector for air outlet
5	Water Tube	Tube connector for distilled water inlet
6	Foot switch socket	A port to connect the foot switch to the main unit for system operation
7	Water Level	Distilled water level check
8	Power switch	Use this switch to connect/disconnect the external power supply.
9	Drainage	Distilled water outlet

1.3.3.3 Handpiece connector



No.	Item name	Description
1	SJ HP Connector	Connector of the SJ HP
2	PS HP Connector	Connector of the PS HP

1.3.3.4 SJ Handpiece (SJ HP)

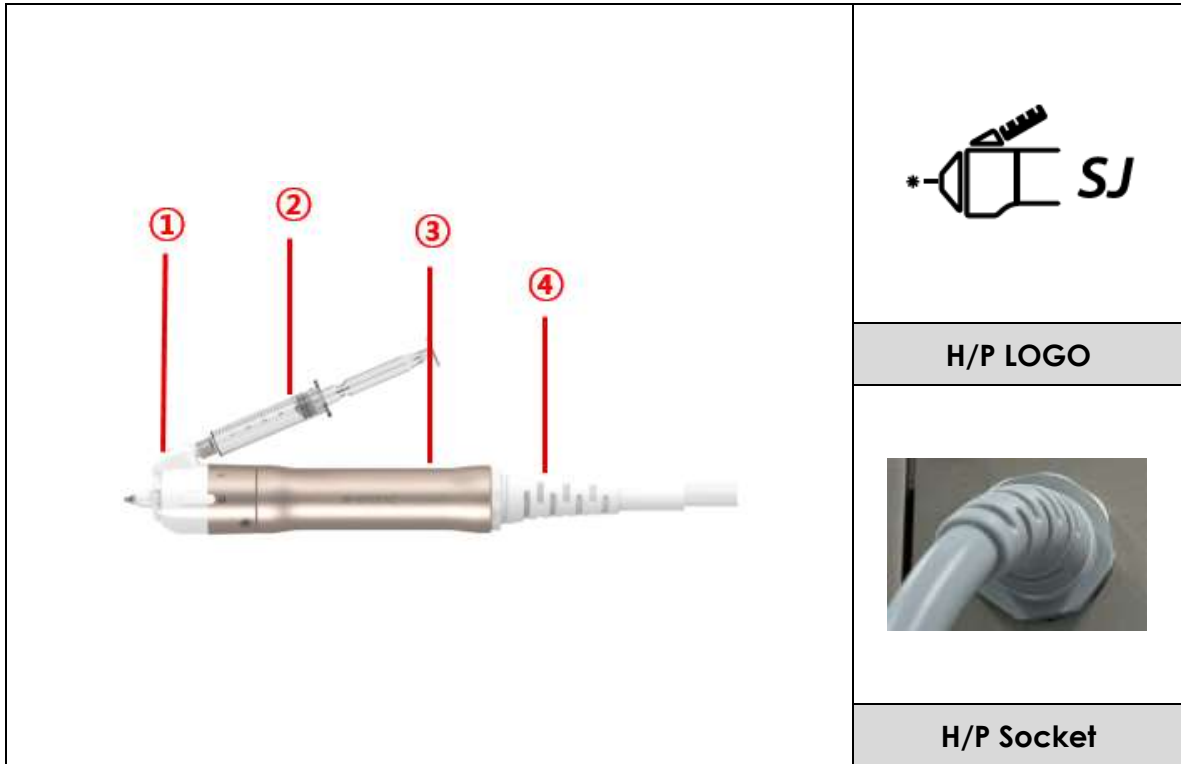

No.	Item name	Description
1	SJ nozzle connection	Connecting Hand piece and SJ nozzle
2	Syringe	Ejecting solution to the nozzle
3	Hand piece handle	Used as a handle during surgery
4	Cable	Connect to the Hand piece connection terminal on the back of the main body (The Hand piece cable is connected to the connection terminal on the back of the main body)

※ SJ Hand pieces must be used in conjunction with SJ nozzles.

1.3.3.5 PS Handpiece (PS HP)

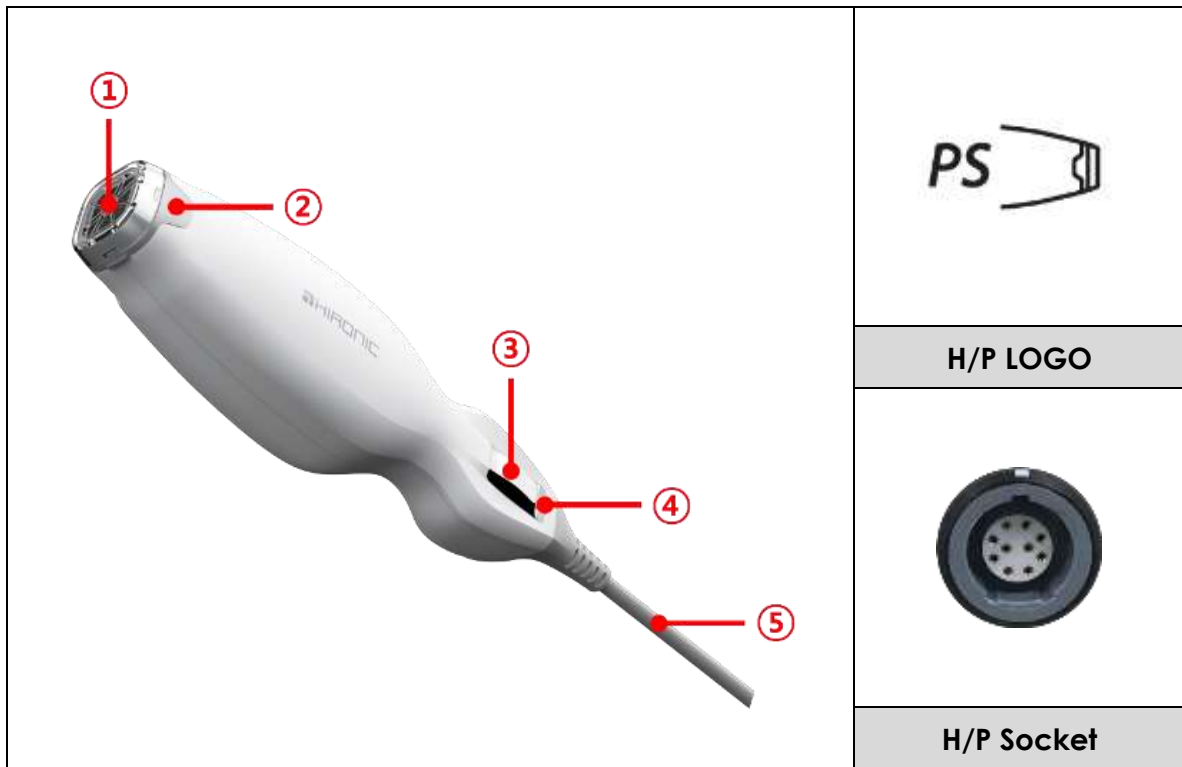

No.	Item name	Description
1	PS tip connection	Connecting the Hand piece and PS tip
2	Hand piece handle	Used as a handle during surgery
3	Hand switch	Control radio frequency (RF) output by pressing
4	Status display LED	Displays the operating status of the Hand piece
5	Cable	Connected to the Hand piece terminal on the back of the main body

※ PS Hand pieces must be used in conjunction with PS Tip (or PS Brush Tip).

1.3.3.6 SJ Nozzle (SJN 130, SJN 180, SJN 230)



No.	Item name	Description
1	Injection part	Exit where chemical liquid is sprayed
2	Syringe connection	Chemical liquid injection passage
3	Hand piece connection	Connecting nozzle and Hand piece

1.3.3.7 EP Tip (EPT 5, EPT 10, EPT 15)

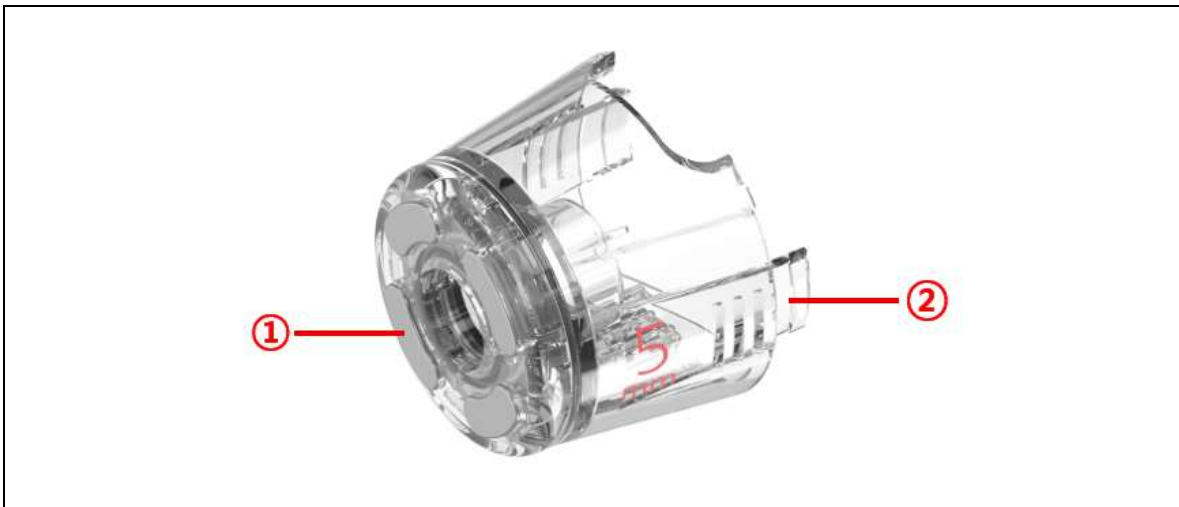

No.	Item name	Description
1	EP irradiation part	The part where low-frequency current is irradiated
2	Hand piece connection	Connecting the tip to the Hand piece

1.3.3.8 PS Tip



No.	Item name	Description
1	PS Tip Protective Cap	Guide used for accurate plasma treatment, Instrument used to prevent damage to the plasma tip
2	Radiation Part	Area where RF radiates
3	Hand piece connection	Connecting the tip to the Hand piece

1.3.3.9 PS Brush Tip



No.	Item name	Description
1	PS irradiation part	The part where RF is irradiated
2	Hand piece connection	Connecting the tip to the Hand piece

1.3.3.10 Handpiece Cable Holder



No.	Item name	Description
1	Hand piece Cable Holder	Holder for holding the Hand piece cable

1.3.3.11 Foot Switch



No.	Item name	Description
1	Exterior cover	This cover/guide prevents the foot switch from being pressed when it has overturned.
2	Foot switch	This switch is equipped with an embedded contact switch, which causes energy irradiation when the foot switch is pressed.
3	Connection cable	This cable transmits foot switch position signals to the main unit.
4	Foot switch connector	This connector connects to the foot switch port in the bottom rear of the system.

1.3.3.12 Power Cable



No.	Item name	Description
1	Power cable	This cable is fixed onto the rear bottom of the main unit to supply external power to the main unit.

1.3.3.13 Cup



No.	Item name	Description
1	Cup	Container provided for multi-purpose use

1.3.3.14 EP Tip Holder

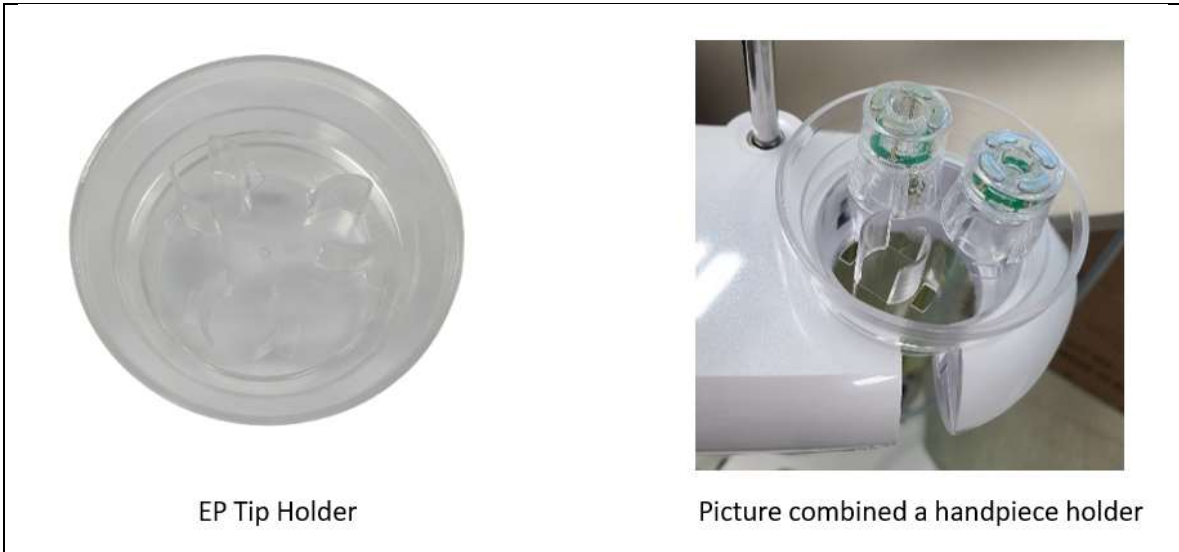

EP Tip Holder

Picture combined a handpiece holder

No.	Item name	Description
1	EP Tip Holder	Holder provided to hold the EP tip

1.3.3.15 User Manual



No.	Item name	Description
1	User manual	Product user's manual

1.3.3.16 Software

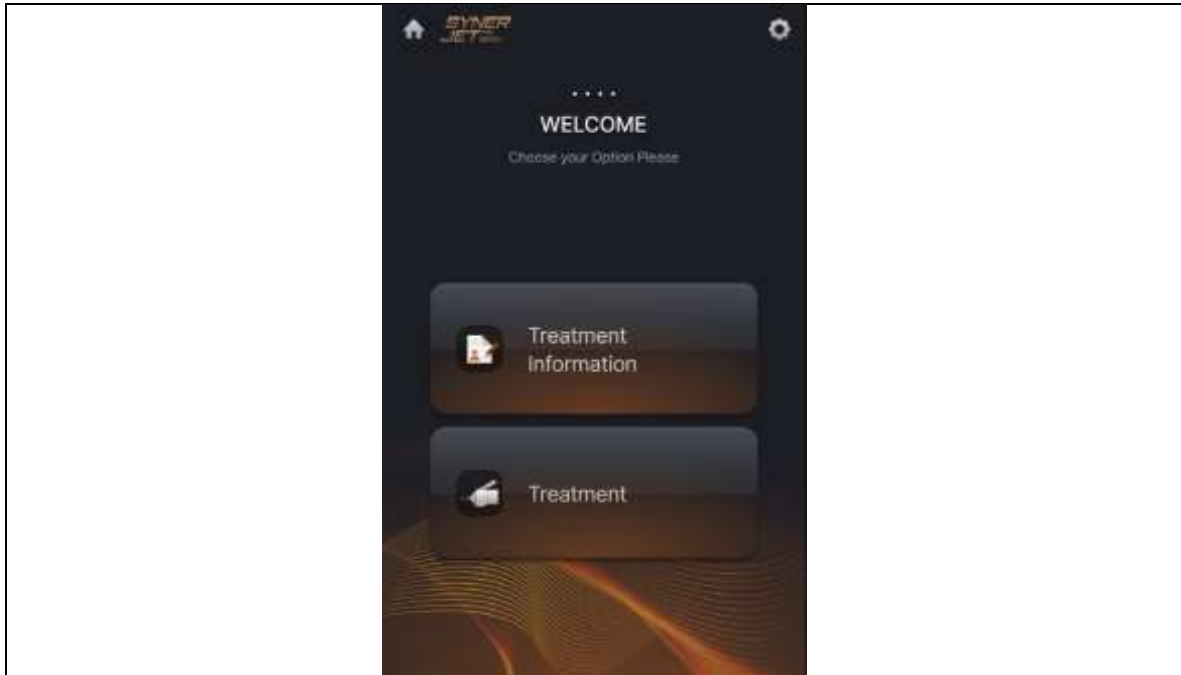

No.	Item name	Description
1	Operation Software	Function: The software is used to configure/manipulate functions and view the system status and settings.

2. General Safety

2.1 Precautions before Use

2.1.1. Check the following before initial locating the product.

- Avoid a location that is humid or exposed to water.
- Locate the device in a location where the device will not be damaged by excessive air pressure, temperature extremes, humidity, lack of ventilation, direct sunlight, dust, salt, or air containing ions.
- Locate the product in a safe location with no slope, vibration and impact.
- Avoid a location where chemicals are stored or gases are generated.
- Pay attention to the power frequency, voltage and allowable current (or power consumption).
- Use a power socket with a grounding terminal. Failing to do so may result in malfunction as this product is affected electrically.

2.1.2. To move the product to another place, follow the steps below.

- First turn off the system and remove the power cable socket.
- In order to ensure that the Hand piece does not fall off while being transported, mount it on the rack securely or hold it separately while carrying it.
- Unlock the brakes on the wheels so that the wheels can roll.
- Hold the handle on the main unit and move the product slowly.
- Be careful so that the Hand piece cable does not bump into other objects during transportation.
- After the moving is finished, lock the brakes on the wheels to anchor the product.
- For a long-distance transportation, separate it from the Hand piece main unit and pack it securely. Pack it securely in order to prevent the main unit from being hit or damaged during the transportation.



Caution

Use caution to minimize impact applied to the product when moving it.

2.2 Power Connection

2.2.1 Checking the grounding status

- Make sure that the power plug is correctly connected. Do not attempt to connect the power cord to the product wet hands. There is a risk of electric shock.

Checking the power cable grounding status



[Cable grounding position]



[Electrical outlet
grounding position]



[Correctly connected]

- Plug the power cable all the way into the electrical outlet to ensure proper grounding. Incorrect connection may cause incorrect grounding on the connector. As a result, the LCD touch panel input may not work properly or the product may malfunction.

How to replace the fuse of the main power switch at the back of the device.



Click the fuse box



Separate the fuse box



Replace the fuse

- The product system is equipped with 2 fuses that automatically cut off current if the allowable current is exceeded.
- To replace the fuse, check the fuse box and press with a finger the indicated part. The fuse box will then be separated. As the fuse box is separated, replace the fuse.



NOTE

The system may not turn on if the power cable is not fully plugged in.
The system may malfunction if it is used in an environment where grounding is not possible

3. How to Use

3.1. Preparations before use

- To use the system, first secure an location space.
 - Avoid locations where strong electricity or a magnetic field is running, as well as locations that can be exposed to heat or moisture. The system may malfunction or break down.
 - Locate the system where proper temperature and humidity can be maintained. Ensure that the interior temperature and humidity of the place where the system is located are maintained between 10 and 30°C and between 30 and 70%.
 - Ensure that the system's vent is at least 30 cm away from the walls.
 - Locate the system on a stable and flat surface.
- Be sure that the handpiece has properly been cleaned using an antiseptic solution (use dedicated cleaning tools) before use.
 - Be sure that the outside of the handpiece is not damaged.
(If there is a damaged part, please consult with Hironic Co., Ltd..)
- Check all components necessary for treatment are properly connected to the main unit before use.
 - Connect every component of the system.
 - Connect the power cable to a grounded outlet.

3.2 Instructions for Use and Handling

- After all the components are connected, use the following steps to apply power to the system.
 - Turn the power switch on the rear side of the device to ON.
 - Position the switch in the front of the device to ON.
- Checking for system failure
 - Turn on and off the switch at the front side of the device and check if it operates properly.
 - Put each hand piece on the main unit's rack and check that they are recognized properly.
- Device booting and initialization
 - If all components, including the hand piece, are properly connected and power is applied, the system performs initialization and checks the connection of the components.



Caution

This product is very sensitive. Please read the user manual thoroughly before using the product. Be careful while using the product and handpiece in order to prevent any problems on them.

- 1) Before turning on the power, read the manual and check the following items in order before use.
 - Check whether the power cable on the rear left panel of the main unit is connected.
 - Check that the power switch on the back of the main unit is on.
 - Check whether the power supplied to the product is the rated power.
 - Check whether the foot switch on the rear right panel of the main unit is connected.
 - Check that the power switch on the front of the main unit is on.

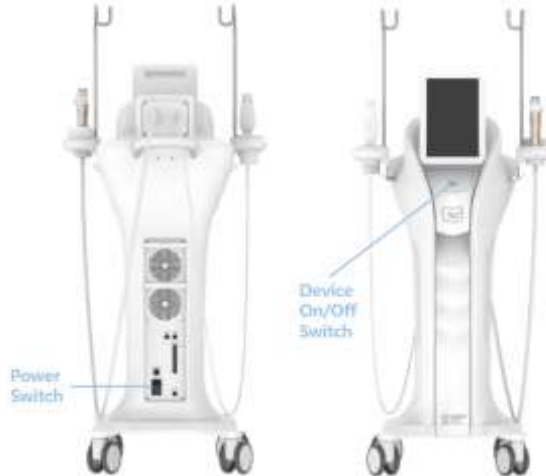

[Power switch and foot switch connection on the back of the main body] [Power switch on the front of the main body]

- 2) Nozzle confirmation before use
 - (1) This product is packaged in complete sterilization, so check whether the packaging is damaged.
 - (2) Check whether the expiration date has elapsed and whether the packaging is damaged.
 - (3) Be familiar with how to use the product.
 - (4) Prepare a dedicated syringe to be used in the nozzle.
 - (5) After all preparation is completed, it is ready for operation.
- 3) Nozzle preparation
 - (1) Open the package after checking the packaged nozzle and the syringe injected with the chemical solution. (The syringe is licensed and certified as a medical device and is sold on the market, and the appropriate dosage is used.)
 - (2) Insert the syringe filled with chemical solution into the hand piece nozzle of the main body in the direction of engagement, then turn counterclockwise and fasten the syringe so that it faces upward.

- (3) Insert the nozzle as shown in the diagram below, aligning it with the Hand piece unlock indication on the main unit, then turn it clockwise towards the lock indication to secure it. (When using SJ Nozzle only)



- (4) After attaching the nozzle to the Hand piece, insert the EP Tip into the SJ Nozzle slot as shown in the diagram below to secure it. (When using SJ Nozzle and EP Tip)



- (5) Turn the nozzle upwards so that the chemical liquid fills the inside of the chamber, and then lightly tap the nozzle about 5 times.
- (6) Since about 0.3 ml of chemical solution remains on average in the chamber, depending on the syringe capacity, the actual amount injected may be 0.3 ml less than the volume filled in the syringe. Therefore, when using a syringe filled with a capacity of 3ml, the actual injection amount is approximately 2.7ml.

- 4) Prepare a PS tip or PS brush tip.
- PS brush tip is used on the scalp.



- 5) Use the PS tip or PS brush tip combined with the PS Hand piece.

Power ON / OFF & Operation

The power switch is located on the back side of the main unit.

For proper operation of the product, turn on the power switch on the back side and use the On/Off switch on the front.







The Device On / Off switch is located on the front side.

For proper operation of the product, press the Device On / Off Switch button and turn it on. While the device is operated, keep the Device On / Off Switch button pressed for 5 seconds to turn off the product.







Device On: White LED Color On
Device Off: White LED Color Off



[SJ Nozzle] How to Connect

<p>(1) Prepare a Hand piece to connect the SJ Nozzle.</p>		
<p>(2) Connect the SJ Nozzle to the Hand piece towards the unlock mark.</p>		
<p>(3) Then turn the SJ nozzle connection clockwise towards the lock mark.</p>		
<p>(4) Check that the connection part between the SJ Nozzle and the Hand piece is aligned and the nozzle is completely fixed to the Hand piece.</p>		

[EP Tip] How to Connect

<p>(1) Prepare a Hand piece to connect the tip.</p>		
	<p>SJ HP (SJ Nozzle connection status)</p>	<p>EP Tip</p>
<p>(2) Check the connection locations of the SJ Nozzle and EP tip.</p>		
	<p>SJ Nozzle connection location</p>	<p>EP Tip connection location</p>
<p>(3) Insert it vertically into the groove of the nozzle.</p>		
<p>(4) The EP Tip, the nozzle and the connection of the nozzle and Hand piece are set in a straight line, so the tip is completely fixed.</p>		

How to replace the PS TIP

※ The connection method for PS Tip and PS Brush Tip is the same.

The PS Tip is a consumable part that can be replaced.

If the Hand piece lens is discolored, blurry or damaged, please contact the Hironic Co., Ltd. after-sales service center.

1. Check the location of the PS TIP where the PS Hand piece is attached.



2. Slightly lift the PS TIP connecting part using the TIP of the Hand piece to detach the TIP.
3. Replace the old tip with the new one.



4. The contact part on the PS TIP is separated from the device as shown in the figure on the right.
5. When connecting the PS TIP to the PS Hand piece, make sure to check the figure on the right.



PS TIP contacting part



PS handpiece contacting part

How to replace the PS TIP protective cap

The PS TIP and PS TIP protective cap are consumable parts that can be replaced.

1. Check for the groove on both sides of the protective cap for the PS TIP as shown in the figure on the right.



Groove of the PS TIP protective cap

2. Grab the connecting part of the PS TIP by hand as shown in the figure on the right.



Handle of the PS TIP protective cap

3. Push the groove part on the PS TIP protective cap where the arrow is pointing using your fingers to detach it from the device.

4. When it is detached from the device completely, replace it with a new PS TIP protective cap.



How to separate the PS TIP protective cap

Locking/unlocking the wheels

The main unit of the product is equipped with four wheels that have locks.

These wheels are designed to stop rolling if the locks are engaged.

Make sure to engage the wheel locks before using the system to prevent the system from moving during radiation treatment.

[Engaging locks]

Step on each lock. The lock lever will descend to lock and prevent the wheel from rolling.

[Disengaging locks]

Raise each lock lever. The wheel will be unlocked, and can roll.



[Locked]



[Unlocked]



Caution

Make sure you lock the wheels before using the system to prevent the system from moving during treatment.



Caution

If wheel locks are engaged with excessive force or engaged in an incorrect direction, the locks may become damaged.

3.3 Using the Screen

- **Initialization screen**

- As soon as power is supplied to the system, the system automatically starts initialization.
- The screen displays the manufacturer's logo and the product's model name.



[Initialization screen – 1]

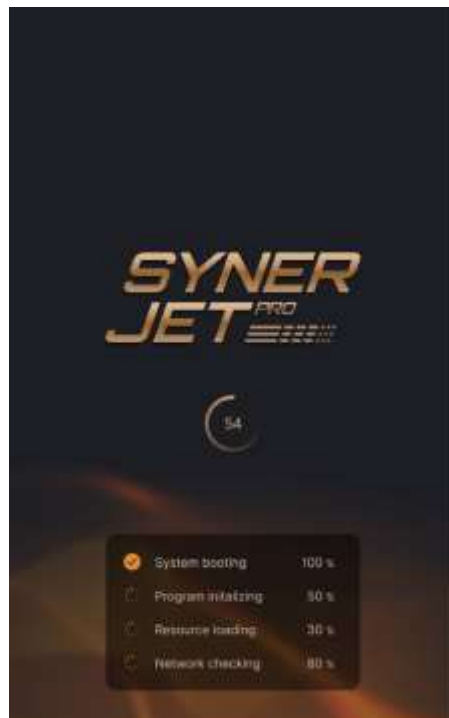

[Initialization screen – 2]

Main Screen

- When Patient Information is selected, a popup window will appear and show patient information.
- When a treatment is to be selected, the screen will lead to the hand piece selection page.

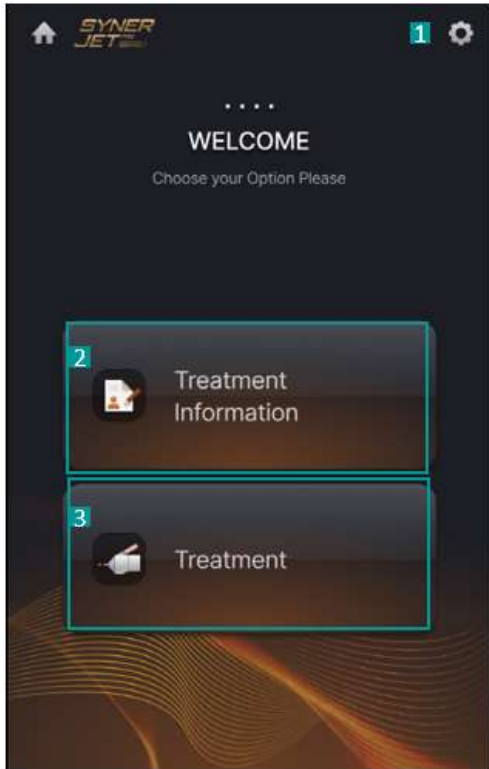

[Main Screen]

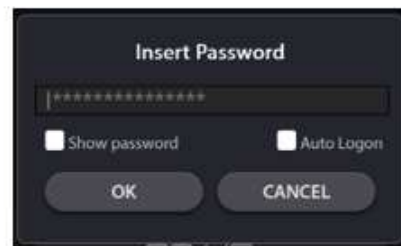

[Insert Password]

No.	Symptom	Steps to take
1		Clicking on the Settings leads to the settings page.
2	Treatment Information	The patient information entry page will appear. - When selected, the 'Insert Password' window will appear.
3	Treatment	This takes the user to the hand piece selection screen.



Caution

Cybersecurity Caution: The set-up is only for administration mode.

- **Patient Information (Treatment History)**

- When **Treatment history** is selected, a popup window will appear and show patient history.



[Screen of Treatment history]



[Screen of Treatment history (Statistics)]

No.	Symptom	Steps to take
1	Treatment history	The Treatment history menu is displayed.
2	Patients information	Patients information menu is displayed.
3	SJ / PS HP	You can check the treatment history by type of hand piece.
4	Information Sorting (Nozzle Size, Period, Mode, Feedback)	You can sorting the treatment history by type of Nozzle type, Period, Part, Feedback
5	Treatment history	You can check and choose from the treatment records by information Sorting
6	STATISTICS	You can see a statistical history graph of the hand piece.
7	TREATMENT	This takes the user to the hand piece selection screen.
8	Statics Information Sorting (Period)	You can sorting the treatment statistics history by type of Day, Week, Month, Year
9	Treatment statistics history screen	You can check and choose from the treatment statistics records of a selected patient. You can check the treatment history by type of hand piece.
10	BACK	Move to the previous page.

• Patient Information

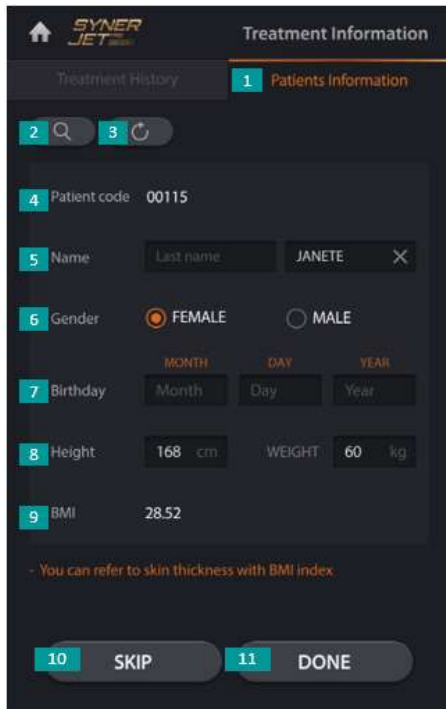

- Upon completion of device initializing, you can save patient information by using the window below. Even if the entry is not completed yet, pressing the "DONE" button will lead to the next page.

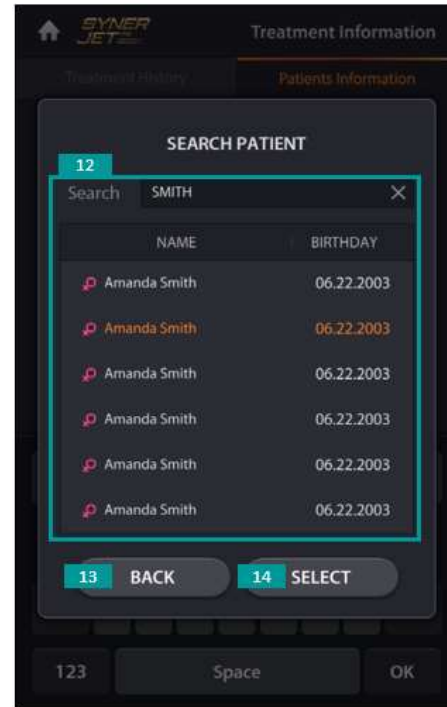

[Screen of patient information entry]

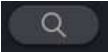

[Screen of the Search patient]

No.	Symptom	Steps to take
1	Patient Information	Patient information is displayed.
2		This menu is used to search patient names. (The Search patient popup page will appear when this menu is selected)
3		Resets input values.
4	Patient code	This shows patient information codes.
5	Name	This is to enter a patient's name.
6	Gender	This is to enter a patient's sex.
7	Birthday	This is to enter a patient's date of birth.
8	Height / WEIGHT	This is to enter a patient's height and weight.
9	BMI	This shows the BMI. (When the height and weight are entered, the value is calculated automatically and displayed) BMI: (weight (kg) ÷ (height (m) x height (m)))
10	SKIP	Skipping the entry of patient information, leads to the treatment page.
11	SAVE	With the entered values saved, the screen moves on to the next page.
12	Search	This is used to search patients.
13	BACK	Move to the previous page.
14	SELECT	Show the selected patient information

- **Selected Patient Information**

- When **Patient Information** is selected, a popup window will appear and show patient Information and Feedback Survey.

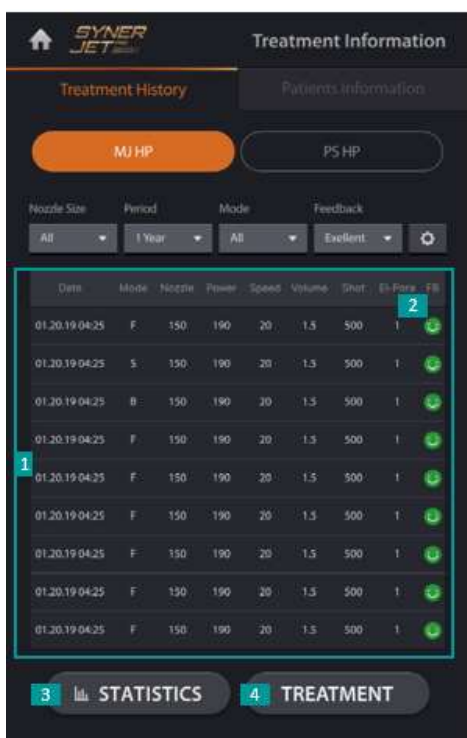

[Patient information]

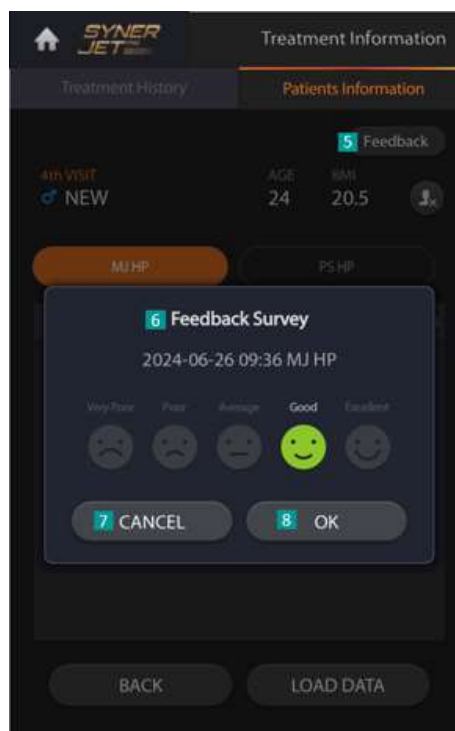

[Feedback Survey]

No.	Symptom	Steps to take
1	Treatment History	Check and select the procedure history of the selected patient. User can check the details of the procedure for each Hand piece.
2	FB	Displays patient's treatment satisfaction.
3	BACK	Move to the previous page.
4	LOAD DATA	Loads patient information.
5	Feedback	The Feedback Survey screen appears.
6	Feedback Survey	The patient's treatment satisfaction is displayed in a 5-level rating scale. <div style="text-align: center;"> Very Poor Poor Average Good Excellent  </div>
7	CANCEL	Cancels a selected feedback.
8	OK	With a patient selected, the screen returns to HOME.

• Treatment History – LOAD DATA



[LOAD DATA screen]



[Patient Treatment Information Pop-up]

No.	Symptom	Steps to take
1	 NEW	Display patient treatment information. When clicked, the patient treatment information pop-up screen appears.
2	Patient treatment information Pop-up	User can check the pop -up screen of the patient treatment information.

• **TREATMENT – Hand piece Selection**

- The GUI screen appears differently depending on how to connect the handpiece connector.



[Main Screen]

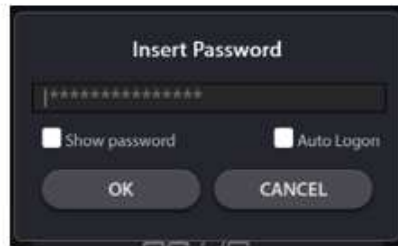

[Insert Password]



No.	Symptom	Steps to take
1		Clicking on the Settings leads to the settings page. - When selected, the 'Insert Password' window will appear.
2	SJ HP	Select SJ H/P icon, leads to the SJ Hand piece settings page.
3	PS HP	Select PS H/P icon, leads to the PS Hand piece settings page.

- **SJ Hand piece Treatment**

- Select the Treatment screen to display the connected Hand piece on the GUI.



[SJ Hand piece Main Screen]

No.	Symptom	Steps to take
1		Goes to the screen where you can select the Hand piece.
2	SJ HP	The mode of the Hand piece is displayed.
3		This icon is displayed on the screen when patient information is skipped in the patient information entry page.
4		Clicking on the Settings leads to the settings page.



• SJ Handpiece Treatment



[Treatment Main Screen]



[Settings screen]

No.	Symptom	Steps to take
1	F / S / B MODE	Set irradiation mode - F mode: Recommended settings mode for use on the face - S mode: Recommended settings mode for use on the scalp - B mode: Recommended settings mode for use on the body (Body image changes when you select the mode.)
2	POWER (V)	Set the output value. - 100 to 200 V (unit: 10 V)
3	SPEED (Hz)	Set the spray speed. - 1~25 Hz (unit: 1 Hz)
4	VOLUME	Set the spray amount. - 1.0 ~ 3.0 (unit: 0.1)
5	EL-PORA (Lv)	Set the output value. - OFF - 1 Lv: 0.95 Vrms - 2 Lv: 1.11 Vrms - 3 Lv: 1.42 Vrms - 4 Lv: 1.59 Vrms
6		F/S/B MODE can access 9 memories each. (The disk shape is recorded.)
7		Wash the nozzle. - 60 Sec (Wash with distilled water.)
8		If the parameter value is changed to a fixed value rather than in the settings screen, it automatically enters the ready state.
9	AUTO / SINGLE	Set the injection mode. - Auto: Continuous mode - Single: Single Mode
10	SHOT COUNT	Displays the total number of shots. (When clicking alarm button, you can set the shots.)
11	STANDBY	It represents the standby status before irradiation. Click Standby to switch to Ready.
	READY	Press the foot switch without the investigation and the shot is irradiated. Click on Ready to switch to standby
12	NOZZLE TYPE	The Nozzle Type recognized through the RFID tag is displayed. - SJN 130: 130 μm - SJN 180: 180 μm - SJN 230: 230 μm

• **SJ Hand piece Treatment (S MODE/ B MODE)**

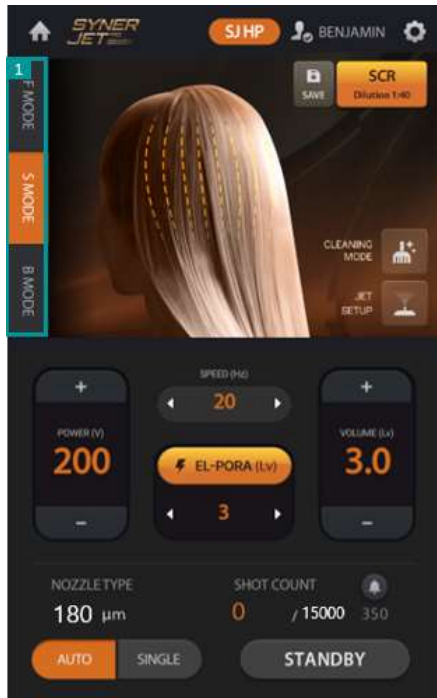

[S MODE Treatment Screen]



[B MODE Treatment Screen]

No.	Symptom	Steps to take
1	F / S / B MODE	Set irradiation mode - F mode: Recommended settings mode for use on the face - S mode: Recommended settings mode for use on the scalp - B mode: Recommended settings mode for use on the body (Body image changes when you select the mode.)

• SJ Hand piece -Operation screen



[EL-PORA (ON)]



[EL-PORA (OFF)]

No.	Symptom	Steps to take
1	Operation status screen	The treatment screen is displayed according to the ON/OFF setting of EL-PORA.

• PS Hand piece (When Using PS Tip)



[Treatment Main screen]



[Tip is not connected]

No.	Symptom	Steps to take
1	POWER (Lv)	The power is adjustable between levels 1 and 5. - 1 Lv : 6 kV - 2 Lv : 7.2 kV - 3 Lv : 8.4 kV - 4 Lv : 9.6 kV - 5 Lv : 10.8 kV
2	CONTINUOUS	Plasma is continuously generated from the Hand piece when the setting is applied.
	SENSITIVE	The mode for sensitive skin
	SOFT	The mode for soft skins
	NORMAL	The mode for normal skin
	AGGRESSIVE	The mode for rough skin
3	ON TIME (s)	When this menu is selected, you can adjust the time of PS operation. (ON – continued repetition, SINGLE- one-time repetition) (0.5 – 5 sec / interval: 0.5 sec.)
4	REPETITION (s)	When this menu is selected, you can adjust the time of the ON Time plasma repetition. (OFF – no repetition / Single - one-time repetition) (0.5 – 5 sec / interval: 0.5 sec.)
5	TREATMENT TIME (m:s)	Displays the treatment time needed for the handpiece. (Minute : Second)
6	TIP REMAINING (h:m)	This shows the remaining time of the tip. (Hour: Minute) If the remaining time is indicated as 0, the tip should be replaced with a new one.
7	STANDBY	The 'STANDBY' button will be changed to the 'READY' button if clicked.
	READY	When a procedure is ready, and energy can be radiated by stepping on the foot switch.

• PS Hand piece (When Using PS Brush Tip)



[Treatment Main screen]



[Tip is not connected]

No.	Symptom	Steps to take
1	POWER (Lv)	The power is adjustable between levels 1 and 5. - 1 Lv : 5.4 kV - 2 Lv : 5.7 kV - 3 Lv : 5.9 kV - 4 Lv : 6.2 kV
2	CONTINUOUS	Plasma is continuously generated from the hand piece when the setting is applied.
	SENSITIVE	The mode for sensitive skin
	SOFT	The mode for soft skins
	NORMAL	The mode for normal skin
	AGGRESSIVE	The mode for rough skin
3	ON TIME (s)	When this menu is selected, you can adjust the time of PS operation. (ON – continued repetition, SINGLE- one-time repetition) (0.5 – 5 sec / interval: 0.5 sec.)
4	REPETITION (s)	When this menu is selected, you can adjust the time of the ON Time plasma repetition. (OFF – no repetition / Single - one-time repetition) (0.5 – 5 sec / interval: 0.5 sec.)
5	TREATMENT TIME (m:s)	Displays the treatment time needed for the hand piece. (Minute : Second)
6	TIP REMAINING (h:m)	This shows the remaining time of the tip. (Hour: Minute) If the remaining time is indicated as 0, the tip should be replaced with a new one.
7	STANDBY	The 'STANDBY' button will be changed to the 'READY' button if clicked.
	READY	When a procedure is ready, and energy can be radiated by stepping on the foot switch.

- **Setting Information**

- Displays the device's Information.



[INFORMATION MENU]





No.	Symptom	Steps to take
1	HOME 	The screen will lead to the Hand piece selection page.
2	INFORMATION	Displays the information.
3	SETTINGS	Displays the settings information.
4	DEVICE S/N	Displays the device's serial number.
5	SOFTWARE VERSION	Displays SYNERJET PRO™ serial No.
6	FIRMWARE VERSION	Displays SYNERJET PRO™ firmware version.
7	COUNTRY CODE	Display the country code of the device.
8	PS HP TOTAL SHOT	Displays the total shot count the PS Hand pieces have been used.
9	SJ HP TOTAL SHOT	Displays the total shot count the SJ Hand pieces have been used.
10	BACK	Returns to the previous page.
11	SAVE	Saves the settings.

- **Setting Information**

- Used to show the device's version and adjust the volume, and confirm / select audio guides.



[Settings Menu]

No.	Symptom	Steps to take	
1		Leads to the Hand piece selection page.	
2	INFORMATION	Displays the information.	
3	SETTINGS	Displays the settings information.	
4	AUDIO GUIDE	Audio language selection of product announcements. (English, Chinese, Korean, Espana, Arabic).	
5		Adjust the volume of the spoken language of the initial message.	
6	BUZZER	Adjusts the Buzzer volume in 4 levels (mute, min, medium, max).	
7	TIME SETTING		When this menu is selected, you can move to the Time Setting screen.
8	Wi-Fi SETTING		When this menu is selected, you can move to the Wi-Fi Setting screen.
9	PASSWORD SETTING		Set ADMIN Setting Password
10	ERROR LOG	Displays error code	
11	BACK	Goes to the Treatment Menu screen.	
12	SAVE	This menu is to save modified information.	

- **TIME SETTING**
 - Sets up the device time



[TIME SETTING MENU]

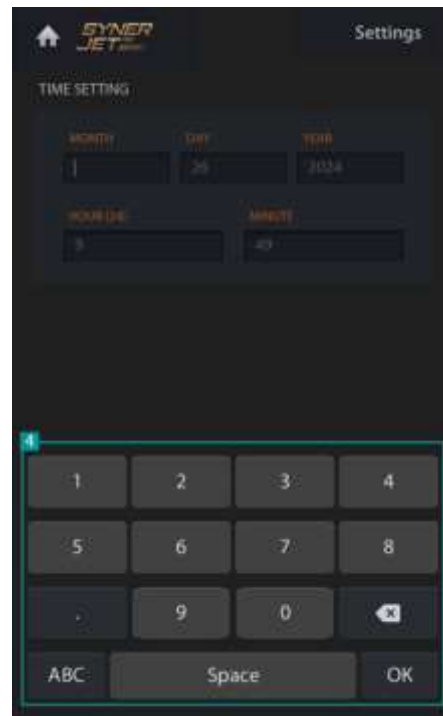

[TIME SETTINGS Menu (KEY PAD)]

No.	Symptom	Steps to take
1	TIME SETTING	Sets up the device time.
2	BACK	Returns to the previous page.
3	SAVE	Save the settings.
4	KEY PAD	Used to select the number to be entered.

- **Wi-Fi Setting screen**



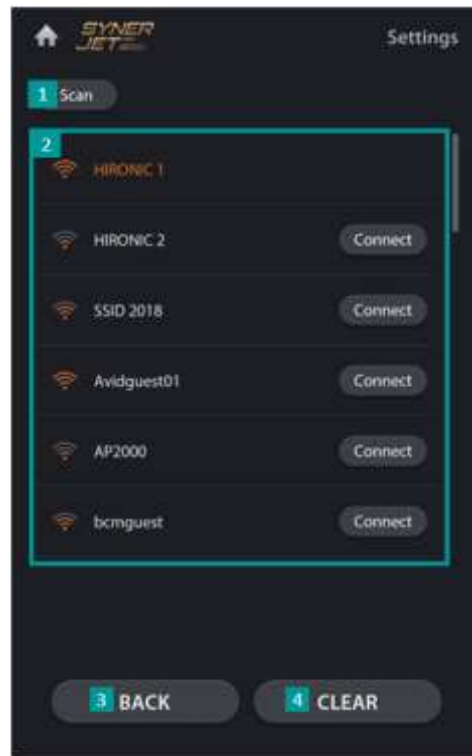





- This menu is used to select the Wi-Fi connection of the device

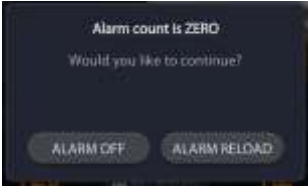

[Wi-Fi Connect Screen]

No.	Symptom	Steps to take
1	Scan	Scans for accessible Wi-Fi signals.
2	Connect	Connects to the selected Wi-Fi signal.
3	BACK	Goes to the Treatment Main screen.
4	CLEAR	This menu used is to reset the information.

[Pop-up messages]

Symptom	Steps to take
	 "Alarm Count Setting" This message will appear when the Alarm button is clicked. ※ Select the desired number of shots and save the setting. The alarm will then be set up. ※ This is to turn the alarm on or off.
	"Please scan RFID" When the SJ Handpiece treatment is clicked, no RFID is scanned. ※ Please SCAN the Nozzle to the RFID TAG of Main Body
	"Alarm count is ZERO" This will appear when the maximum shot counter has been reached. - Replace the Nozzle or Tip with a new one. - When the memory of Nozzle or Tip has been deformed. (When the number of shots used has changed)
	"WARNING – Foot Switch is not connected" This message appears when no Foot Switch has been connected. - Please connect a Foot Switch
	"Check error H/P Connect" This message appears when no Handpiece has been connected. - Please connect SJ Handpiece or PS Handpiece
	"Nozzle Cleaning – Start nozzle cleaning. Fill the syringe with at least 2 ml of distilled water. It takes about 30 seconds" This message appears when the icon () has been clicked. - If there is no need for the nozzle cleaning, click the 'CANCEL' button - If there is a need for the nozzle cleaning, fill the syringe with at least 2 ml of distilled and click the 'OK' button.
	"Nozzle Cleaning-Remaining nozzle cleaning time" This message appears when the 'OK' button of Nozzle Cleaning has been clicked. The message presents time for cleaning (End time: 30 seconds). - If there is no need for the nozzle cleaning, click the 'CANCEL' button.

4. Maintenance and Storage

4.1 Storage and Maintenance after Use

- The system and components should be inspected on a regular basis.
- If an impact is applied to the main unit and components, the device may come to be damaged.
- If it is deemed that the system does not operate properly or has broken down, please contact the manufacturer for assistance. Do not arbitrarily disassemble the system.
- To use the system after it has been unused for an extended period of time, first check that the system is clean, safe and working properly.
- The nozzle used in this product is a disposable product, so user has to discard it without reusing.

(1) Electrosurgical System

- PS Tips and PS Brush Tips - check if there are contaminants or foreign substances after use and wash with gauze and 70% alcohol.

(2) Injector, Jet, Mechanical-Powered

- SJ Nozzles are disposable and discarded according to the hospital procedure without reuse.

(3) Low frequency electric stimulator

- The EP Tip checks for contaminants or foreign objects after use and washes with gauze and 70% alcohol.

4.2 Precautions for Storage

- Store the system in a place that is not affected by direct sunlight, moisture, atmospheric pressure, temperature, humidity, ventilation, sun rays, dust, or air containing salt.
- Do not store the system in a bathroom or other places that are highly humid.
- Ensure that the system is maintained in a safe state under any conditions, including when the system is transported, to ensure protection against slopes, vibration or excessive force.
- The product should be stored in a clean state so that it does not interfere when using it next time.



NOTE

	Operating conditions	Transport and Storage conditions
Temperature	10°C ~ 30°C	10°C ~ 40°C (SJ Nozzle: 10°C ~ 25°C)
Relative humidity	30% ~ 70%	30% ~ 70%
Atmospheric pressure	80 ~ 106 kPa	80 ~ 106 kPa

4.3 Preparations for Transportation

Follow these procedures before transporting the device:

- Detach the handpiece, foot switch, and other components.
- Seal the handpiece and accessories safely before transport so that they are not damaged.
- Put the system in a dedicated transport box. Exercise caution to ensure that the system does not collide with other objects during transportation.
- If a dedicated storage box is not available, pack the system with other material that can prevent excessive force or scratches.

4.4 Cleaning

- Use a soft brush to remove dust and other foreign materials off the electrical outlet.
- Always check that there is no foreign material found in or on the electrical outlet before connecting the power cable.
- Use a soft cloth to wipe the main unit.
- Do not use water or oils such as benzene or thinner, to clean the system.
- Use exclusive cleaning tools (lens cleaning tissue, proper cleaning tools, etc.) to clean the handpiece and dry thoroughly for storage.
- After using the system, make sure you turn it off and use a dry cloth or soft brush to wipe the system.
- Do not touch the front of the system with wet hands.



Caution

Never dip a Hand piece into solution since it can be damaged. After each use, clean the Hand piece.





NOTE

If it is deemed that the system does not operate properly or has broken down, please contact the manufacturer for assistance. Do not arbitrarily disassemble the system. If the product has been disassembled arbitrarily and the product malfunctions, the issue will not be covered by our paid or free-of-charge repair service. We hereby notify that we will not and shall not be held accountable for any and all legal problems caused by disassembly at your discretion.

5. Troubleshooting

5.1 Steps to Take in Emergency Situations

Symptom	Steps to take
Burning smell is coming from the product Abnormal noise is coming from the product	<ul style="list-style-type: none"> * Use the power button on the rear side of the system to turn it off. * Unplug the power cable from the electrical outlet. * Contact the original distributor or our after-sales service center. <div style="border: 1px solid black; padding: 5px; margin-top: 10px;">  Caution If the product is used continuously, internal modules may become damaged one after another and fire or safety accidents may occur. </div>
The display screen is broken or damaged	<ul style="list-style-type: none"> * Immediately stop the treatment and use of the product. * Turn off the system and remove the power cable from the electrical outlet. * Contact the original distributor or our after-sales service center. <div style="border: 1px solid black; padding: 5px; margin-top: 10px;">  Caution If the touch screen is broken and the system is used continuously, energy will not be irradiated uniformly and the patient's skin may become damaged. </div>
Blisters or burns are present in the treated area	<ul style="list-style-type: none"> * Immediately cool the affected area. Apply burn ointment to the area to hasten skin regeneration, if necessary. * Contact the original distributor or our after-sales service center.

5.2 Troubleshooting by Symptom

Symptom	Steps to take
The system cannot be turned on	<ul style="list-style-type: none"> • Check if power is applied to the electrical outlet and the plug is inserted properly. • Confirm that the power cable is firmly connected to the system. • Confirm that the power switch (circuit breaker) on the rear of the system works properly. (If over current enters the system, the circuit breaker may not work properly.) • If the main unit still does not operate properly after checking the above, contact the original distributor or our after-sales service center.
The main power switch (circuit breaker) on the rear of the system does not work properly	<ul style="list-style-type: none"> • Turn off the power switch (circuit breaker) on the rear of the main unit. • Check the power cable connection and confirm that the system can be turned on/off. Turn the Device On / Off switch on the front of the system on and off 2 or 3 times repeatedly. If the main unit does not respond, contact the original distributor or our after-sales service center.
Loud noise is audible	<ul style="list-style-type: none"> • Check if the product is placed on a flat and stable surface. • Check if the product is located at least 30 cm away from the wall. • Contact the service center if the device makes a loud or irregular noise.

5.3 Cybersecurity Response Method

Symptom	Steps to take
When the RMS server does not work	<ul style="list-style-type: none"> • If an error occurs when updating S/W after turning on the RMS server while connected to WIFI, contact the service center. • If an error occurs when updating F/W after turning on the RMS server while connected to WIFI, contact the service center.
If an error occurs after RMS update	<ul style="list-style-type: none"> • If an error occurs or the device is stopped after RMS update, it is caused by failure to verify the sterility of the file. Please contact the service center.

6. Warranty

6.1 Overview

This section describes the warranty coverage for normal use of the product and exceptions to the warranty.

6.2 Warranty Coverage

- If the product has been used for intended purposes, Hironic Co., Ltd. provides a warranty for one year after delivered.
- Free-of-charge warranty covers the main unit and applicator. Consumable components are excluded.
- If you request repairs that fall within the required conditions for the warranty coverage, repair or replacement will be performed at either the head office of Hironic Co., Ltd. or the location where the product is delivered, depending on the target component for repair and the period of time required for the repair.
- When making a warranty claim, the user should provide Hironic Co., Ltd. with materials, video or photos that show details of the problem.



NOTE

- **To maintain free-of-charge warranty, repair or modification shall be performed by service personnel officially appointed by Hironic Co., Ltd. If the product was not used for the intended purpose or the instructions herein were not followed and the product malfunctions, the issue will not be covered by the warranty. Make sure you thoroughly read and understand the user manual. Hironic Co., Ltd. shall be responsible and entitled to make a decision regarding details and the cause of a damage in the product; the decision is final and subject to no change.**



NOTE

- **If the system has been disassembled or modified arbitrarily and the system malfunctions, the issue will not be covered by the warranty.**

6.3 Exceptions to the Warranty

Problems caused by failure to follow the instructions and safety precautions suggested in this manual will not be covered by the warranty. The following instructions need to be followed with extra caution when using the product.

- Damage to the main unit or Hand piece, caused due to the user's negligence when using or moving the product, is not covered by the warranty.
- The warranty is void if the product has been used for unintended purposes or it has been altered or disassembled.
- Consumables are not covered by the warranty.
- Damage or loss due to the user's carelessness is not covered by the warranty.
- The warranty is void if a damage has occurred due to disassembly of or shock to the system or applicator (including the cables), the applicator has been removed from the main unit with an excessive force and damaged, or the system has been disassembled or repaired by someone that is not a service technician authorized by Hironic Co., Ltd.
- The warranty is void if a seal on the product has been damaged without permission by Hironic Co., Ltd.

**NOTE**

Use only genuine components and consumable parts supplied by the manufacturer. Do not modify or alter the product. Damage caused by unauthorized tampering is not covered by the warranty.

Warranty Certificate

This warranty certificate supersedes any explicit or implied warranties. The seller cannot guarantee the warranty or the conditions of the product.

Hospital name	
Name	
Address	
Contact info.	
Mobile	
Email	
Product name	SYNERJET PRO™
Serial No.	
Delivery date	
Warranty expiration date	
Seller/Company	
Seller contact information	
Others	

Important!

To take full advantage of your warranty, please send the details above via email.

You can send the details via fax, but you will need to notify a contact person at Hironic Co., Ltd. in advance.



Hironic Co., Ltd.

19F, U-TOWER, 767, Sinsu-ro, Suji-gu, Yongin-si,
Gyeonggi-do, 16827, Republic of Korea

Tel. +82-31-525-7000

Fax. +82-31-525-7010

www.hironic.com

Customer Support Center

Tel. +82-31-525-7600

E-mail: ocs@hironic.com

SYNER™ **JET^{PRO}**

USER MANUAL



Hironic Co., Ltd.
19F, U-TOWER, 767, Sinsu-ro, Suji-gu,
Yongin-si, Gyeonggi-do, 16827,
Republic of Korea
Tel. +82-31-525-7000
Fax. +82-31-525-7010
www.hironic.com

Customer Service Center
Tel. +82-31-525-7600
E-Mail: ocs@hironic.com

HIRONIC