

# PICOHI™ 300

## USER MANUAL

<b>PRODUCT</b>	Q-Switched Nd:YAG Laser
<b>MODEL</b>	PICOHI™ 300



# TABLE OF CONTENTS

Introduction	Copyright	3
	Intellectual Property Rights / Purpose of Use	3
	Uses of Product / Safety Precautions	4
	Contraindications	5
	Warning	6
	Precautions for Use / Restrictions for Use	7
	Electrical Hazards	7
	General Precautions	8
	Interaction / Precautions for Use	9
	Safety Precautions to Prevent Accidents	9
	Side Effects	10
	Definitions of Symbols and Labels	11
	Locations of Labels	13
	<hr/>	
1. Product Overview & Components	1.1 Overview of PICOHI™	16
	1.2 Product Performance	18
	1.3 Components and Functions	21
<hr/>		
2. General Safety	2.1 Checklist before Use	40
	2.2 Power Connection	41
<hr/>		
3. How to Use	3.1 Preparations before Use	43
	3.2 Using the Product	43
	3.3 Using the Product Screen	54
<hr/>		
4. Maintenance & Storage	4.1 Storage and Maintenance after Use	74
	4.2 Precautions for Storage	74
	4.3 Preparations for Transportation	75
	4.4 Cleaning the Product	75
<hr/>		
5. Troubleshooting	5.1 Steps to Take in Emergency Situations	79
	5.2 Steps to Take by Symptom	80
	5.3 Error Message	81
<hr/>		
6. Warranty	6.1 Overview	82
	6.2 Warranty Coverage	82
	6.3 Exceptions to the Warranty	83
<hr/>		
Warranty Certificate	Warranty Certificate	84

### Copyright

---

Copyright 2023. Hironic Co., Ltd. All rights reserved.

The product referred to herein is protected by the Industrial Property Act and other domestic and international intellectual property rights, including copyrights. Unauthorized duplication or use of this product without prior written consent by Hironic Co., Ltd. is prohibited.

### Intellectual Property Rights

---

PICOHI™ 300-related intellectual property rights referred to herein include all of the patent, trademark and design rights applied for or registered in Korea and other countries. All of the rights related to this product are protected by relevant intellectual property rights.

The product referred to herein is protected by Hironic Co., Ltd.'s intellectual property rights, including the patent rights and their patent family, as well as trademark rights and design rights. Unauthorized use of this product is an infringement of Hironic Co., Ltd.'s intellectual property rights and may be subject to civil and/or criminal penalties.

### Purpose of Use

---

#### Laser, Surgical, Nd:YAG

PICOHI™ 300 uses Nd:YAG as the medium for purposes of incision, destruction and removal of body tissues.

#### Laser, surgical, dye

Laser surgery using pigment as a medium for incision, destruction and removal of tissue

#### Laser protective goggles

These goggles are worn by the operator who uses the Laser, Surgical, Nd:YAG to prevent a laser beam, reflecting off an object, from adversely affecting their eyes.

### Uses of Product

---

This product is an "Laser, Surgical, Nd:YAG" and composed of Nd:YAG which is a 1064 nm medium and solid-state laser and of KTP which is a 532 nm medium. The energy with wavelengths of 1064 nm and 532 nm, generated by a laser, is irradiated into cells or tissues of skin to increase temperature of the tissues due to the selective photothermolysis theory. Thermal energy is produced during this process, and the "Laser, Surgical, Nd:YAG" uses this thermal energy to incise, destruct and remove tissues. Dye laser surgery using a solid pigment as a medium is a laser surgery for cutting, destroying, and removing the tissue by the heat effect selectively absorbed into the tissue by using the characteristics of different absorption rate in the biological tissue.

### Safety Precautions

---

#### **Precautions to follow to prevent safety accidents when using PICOHI™ 300 are as follows.**

- \* Make sure that both the operator and the patient wear protective goggles before using the system. Direct eye exposure to laser beam may cause loss of sight.
- \* Remove any objects that may reflect laser beam, such as mirrors and glasses, out of the treatment room.

#### **Precautions to follow when using PICOHI™ 300 based on prescription by a medical specialist are as follows.**

- \* Do not use the system on burn patients.
- \* If the patient has herpes simplex, reduce the laser output power when treating an area where herpes appears frequently.
- \* Before treating a patient with eczema, consult a medical expert and check the skin condition.
- \* Use caution and check the skin reaction when treating patients with severe skin allergies.

### Contraindications

---

**PICOHI™ 300 must not be used on patients with the following symptoms.**

- \* Patients who suffer from skin allergies or burns
- \* Patients with surgical wounds
- \* Patients with fillers or implants
- \* Patients with a history of suffering from skin rash sensitive to sunlight
- \* Pregnant women
- \* Infants, children or adolescents
- \* Patients who took oral isotretinoin, such as Accutane, for six months
- \* Patients who suffer from a local or systemic infection or have wounds on the target area of their body for irradiation
- \* Patients with a local or systemic disease or patients who are being checked for a disease
- \* Patients with lupus (tuberculoderm)
- \* Patients with general acquired nevi that may develop into malignant melanoma
- \* Patients with herpes simplex on the target area of their body for irradiation
- \* Those who took prescription medication or non-prescription medication, including medicinal herbs or medicine made with natural ingredients (Photosensitivity may occur)
- \* Those who take anticoagulant
- \* Those who are allergic to medicine, latex or other materials used before, during or after treatment
- \* Those with malignant lesions on the target area of their body for treatment
- \* Those with herpes simplex on the target area of their body for treatment
- \* Those with a risk of epileptic seizures during treatment with laser radiation
- \* Those with wounds on the target area of their body for treatment
- \* Those with excessively tanned skin
- \* Patients with keloids (It is highly likely that using the system on a patient with skin injury, including injury caused by treatment with laser radiation, may leave a scar.)
- \* Those who suffer from active infection or immunological inhibition
- \* (Active infection and immunological inhibition reduces regenerative capability. Treatment should be given after infection disappears.)

### Warning

---

- \* Using this system for other purposes than the intended use is prohibited. Ensure that the system is not used by someone that is not a permitted user (doctor).
- \* Do not look directly/indirectly at the system when in use. Emitted or irradiated laser beam may damage your retina and result in loss of sight.
- \* Make sure the radiographer, assistant radiographer, operating surgeon and any other staff who are directly exposed to the laser system wear laser protective goggles.
- \* Before using this laser system, first establish an environment where the interlock function can be used.
- \* Do not use this product and other electric devices at the same time. There are no research results in regard to using this product together with an implanted electronic medical device or electronic life-support system.
- \* Make sure the system is neither pointed at nor used on a body part of the patient that may cause damage to their eye or body tissues.
- \* Make sure the radiographer, assistant radiographer, operating surgeon and any other staff engaged in laser irradiation wear appropriate protective goggles.
- \* Make sure you remove any metal or jewelry from the target area of the patient's body prior to irradiation.
- \* Make sure you wear protective goggles appropriate for the Nd:YAG wavelength (wavelength: 532 nm / 1064 nm) when using the system.
- \* Make sure no inflammables, e.g. anesthetic or solvent, are placed close to the system.
- \* Irradiation to an absorbent object within the range of this laser system's absorption wavelength or infrared wavelength may cause ignition. Use extra caution when using the system.
- \* Make sure an activated laser beam is only pointed at the target body part for irradiation.
- \* Keep the system in standby mode when laser is not in use. Laser is not activated by itself while in standby mode.
- \* Ensure that all staff know how to turn off the laser system in an emergency situation.
- \* Do not use this system in a location exposed to a lot of oxygen.
- \* Only use the system on healthy skin. There may be particles of survived tissues included in laser plume. If you are not sure how good skin condition is, use an appropriate medical smoke evacuator.
- \* Make sure the spot identification cable is properly connected to ensure automatic spot recognition.
- \* After use, remove the key switch to prevent the system from being used by unauthorized staff.
- \* Patients who recently got a tan should be given treatment after 2 to 3 months.
- \* This system must be used on intact skin free of damage.
- \* Do not use the system on an area near the outer canthus of eye.

### Precautions for Use

---

- \* Continuously monitor the system and patient to make sure that there is no problem during the treatment process.
- \* If a problem is found with the system or patient, stop operation of the system and take other adequate measures while keeping the patient safe.
- \* Be careful to ensure that the patient does not come into contact with any part of the system during treatment.
- \* If the product is used on the same body part for an extended period of time, there is a risk of "burn" injury. Use extra caution.
- \* If an emergency situation occurs when using the system, immediately press the emergency switch key. Then contact a specialist for assistance and take adequate measures.
- \* Do not immerse the system in liquids. Optical devices inside the system may become damaged.
- \* Do not use a scouring agent, steel wool or other inappropriate cleaning tools, e.g. metal brush which may cause damage to the system.
- \* Do not use strongly alkaline or acid solution on the product.
- \* Make sure the patient and any third parties use accessories and components specified by the manufacturer, so as to ensure user safety. If accessories or components made by other manufacturers are used, the system's durability may decrease due to interference by or increase in emission of electromagnetic wave.

### Restrictions for Use

---

- \* The patient's health condition should be checked before deciding whether to use the system on them and selecting the laser output level. There is no age or gender restriction on use of the system..

### Electrical Hazards

---

- \* This laser system uses high voltage. Ensure that the protective cover is not opened by anyone that is not a qualified technician.
- \* Do not use this laser system close to other electric devices. Do not attach the system to other electric devices for use. If the laser system has been attached to or placed close to another electric device for any reason, monitor the system to make sure the laser irradiation works properly.
- \* A portable mobile radio frequency (RF) communication device may affect laser irradiation.
- \* When this system is operating, turn off your cell phone and any other electric devices.



#### Caution

**Use of controls or adjustments or performance of procedures other than those specified herein may result in hazardous radiation exposure**

### General Precautions

---

- \* To use the laser system, first make sure you are thoroughly familiar with the user manual. Then receive all necessary technical training and check to make sure that the system is working properly before.
- \* Make sure a laser warning label is posted at the entrance to the room where laser radiation is emitted.
- \* This laser system is medical equipment and must be used for medical purposes only.
- \* The operator should make themselves thoroughly familiar with the instructions specified in the user manual, take proper safety actions and be on guard against possible dangers at all times.
- \* Do not arbitrarily disassemble or modify this system.
- \* Only the manufacturer or authorized personnel for repairs may handle/fix the system.
- \* Before use, make sure you get familiar with the safety instructions specified by a professional technician and the manufacturer and receive related technical training.
- \* Make sure you ground the main unit.
- \* Only use components that have been supplied with the system.
- \* Do not apply an arbitrary or excessive impact to the main unit.
- \* This system falls under the category of laser safety class 4 devices. Use extra caution when using the system.
- \* Do not use an electric generator or x-ray system, which uses large current in a short moment of time, in the vicinity of the system. Do not use the system in a location exposed to excessive electromagnetic wave.
- \* Use non-flammable materials for anesthesia, skin preparation, and cleaning and sterilization of the system.
- \* Minimize use of inflammables, e.g. alcohol, in the treatment room. To use a gauze pad during treatment, first wet the pad with water.
- \* Make sure the treatment room is furnished with fire extinguishers and water all the time.
- \* To locate or remove the arm, contact an aorized technician. Do not attempt to locate or remove it by yourself.



#### Caution

**Control, adjustment or execution of procedures that are not specified here may cause exposure to hazardous radiation.**



#### Caution

**Handpieces are consumable items. If PICOHI™ 300 is used for a long period of time, the handpiece lens may become damaged. Use caution to ensure that the lens is not damaged.**

### Interaction

---

- \* Do not use the system and other electric devices at the same time. There are no research results in regard to using the system together with other devices.
- \* Do not use an electric generator or x-ray system, which uses large current in a short moment of time, in the vicinity of the system. Do not use the system in a location exposed to excessive electromagnetic wave.

### Precautions for Use

---

- \* Use caution to ensure that the emitted laser beam does not leak to the outside of the irradiation room during irradiation.
- \* Exercise caution to ensure that the laser beam is not emitted toward a glass, mirror or other materials that can easily reflect light.
- \* Make sure the radiographer, assistant radiographer, operating surgeon and any other staff who are directly exposed to the laser system wear laser protective goggles.
- \* Before using the system, make sure the articulated arm, handpiece, foot switch and other accessories are attached to the system correctly.
- \* Before using the system, make sure all power cords are connected correctly.
- \* If the system has not been used for an extended period of time, make sure that the system operates properly before use.
- \* Use this system in a well-ventilated place.
- \* If the system malfunctions, do not arbitrarily disassemble or use the system. Make sure the system is repaired by a technician authorized by the manufacturer.
- \* High voltage runs inside the system. Do not arbitrarily modify or disassemble the system.

### Safety Precautions to Prevent Accidents

---

- \* Do not place any inflammable material near this laser system.
- \* Do not use the system in a place where adverse effects are expected due to atmospheric pressure, temperature, humidity, ventilation, dust, salt, air containing sulfur, or liquid such as water.
- \* Avoid using the system in a location where chemicals are stored or gas is generated. Avoid using the system around inflammable material.
- \* Use standard power frequency, voltage and permitted electric current (or power consumption).
- \* Perform inspection and maintenance regularly.
- \* Make sure a fire extinguisher is located in the location where the system is used.
- \* Do not place the system near inflammable materials, such as anesthetic or solvent.













### Side Effects

---









- \* If an excessive energy level is used, blisters, hypopigmentation, hyperpigmentation or other side effects may occur.
- \* Make sure no salt, acidity or other cauterants are included in the air. These pollutants may damage electric wires or the surfaces of optical components.
- \* Minimize the presence of dust or hair particles. Shaving of the patient should be performed in a separate location. Particles of dust or hairs may cause permanent damage to optical components.
- \* Hypopigmentation
- \* Pains during treatment (Local anesthesia is not necessary)
- \* Red spots or edema immediately after treatment (These symptoms disappear within several hours or days)
- \* Raw skin or scabs
- \* Blisters (Formed on the outer layer of skin and usually get healed without scarring)
- \* Temporary pigment variation, tissue variation and scars
- \* Purpura and hemotelangiosis
- \* Bruise, numbness, continuous burning sensation
- \* Hemorrhagic blister
- \* Melasma
- \* Swelling
- \* Superficial thrombosis, thrombophlebitis
- \* Cold urticaria
- \* Petechial hemorrhage
- \* Atrophy
- \* Paradoxical hirsutism
- \* Immunoreactivity
- \* Canities
- \* Low clinical response

## Definitions of Symbols and Labels

Symbols that can be found on the components, accessories, or the packaging that come with the system are as follows:

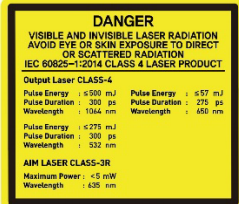
Symbol / Label	Description
	Indicates a potential threat that may result in death or serious injuries to the practitioner if the instruction is neglected.
	Provides important information on using the system.
	Indicates the address of the product manufacturer.
	Indicates the manufacture date of the product.
	Indicates that the product belongs to Type B Applied Part, based on the standards of protection against electric shock (IEC 60601-1 5840).
	Indicates a type BF applied part; this is in accordance with the regulation for protection against electric shocks (IEC 60417-5333).
	Indicates that the product cannot be disposed as general waste, according to the EU Waste Electrical and Electronic Equipment Directive (Directive 2002/96/EC & EN50419). A waste product must be collected separately for recycling. For information about disposing of the product, contact Hironic Co., Ltd.
<b>ON / OFF</b>	Indicates turning on/off of the product.
	Indicates the serial number of the product.
	Indicates "Warning, laser beam"
	Indicates possibility of electromagnetic interference.
	Indicates that instructions in the user manual must be followed.
	This ON message indicates the key switch which is used to turn on the product. Located next to the key switch,
	This OFF message indicates the key switch which is used to turn off the product. Located next to the key switch,

## Introduction

Symbol / Label	Description
	To prohibit pushing against an object.
	this symbol indicates the location of the remote interlock circuit which can connect to the door switch if the door is opened during laser irradiation.
	<b>[LABEL 1]</b> Indicates the emergency button. The emergency button is used to immediately stop the system if the system malfunctions or an emergency situation occurs during operation of the system.
	<b>[LABEL 2]</b> Indicates the following warning: Class 4 device, Avoid exposure of eyes or skin to laser beam radiation
	<b>[LABEL 3]</b> Indicates the following warning: Class 4 device, Avoid exposure of eyes or skin to direct or scattered radiation if the interlock or laser radiation is off.
	<b>[LABEL 4]</b> Indicates the following warning: Class 4 device, Avoid exposure of eyes or skin to laser beam radiation or scattered light IEC 60825-1:2014 Class 4 Laser
	<b>[LABEL 5]</b> Product Label Product Name : Laser, surgical, Nd:YAG Model : PICOHI™ 300 Dimension (WxHxL) : 457mm x 990mm x 1045mm Weight : 150Kg
	<b>[LABEL 6]</b> Indicates the spot on the PICOHI™ 300 through which a laser beam is irradiated.
	<b>[LABEL 7]</b> Articulated arm Label
	Package Box Label

※ It is recommended that the descriptions of signs and indications displayed on the screen be thoroughly read and understood before using the PICOHI™ 300.

## Locations of Labels

Labels are located on front or the rear of the Main unit.

### [Labels on the front]

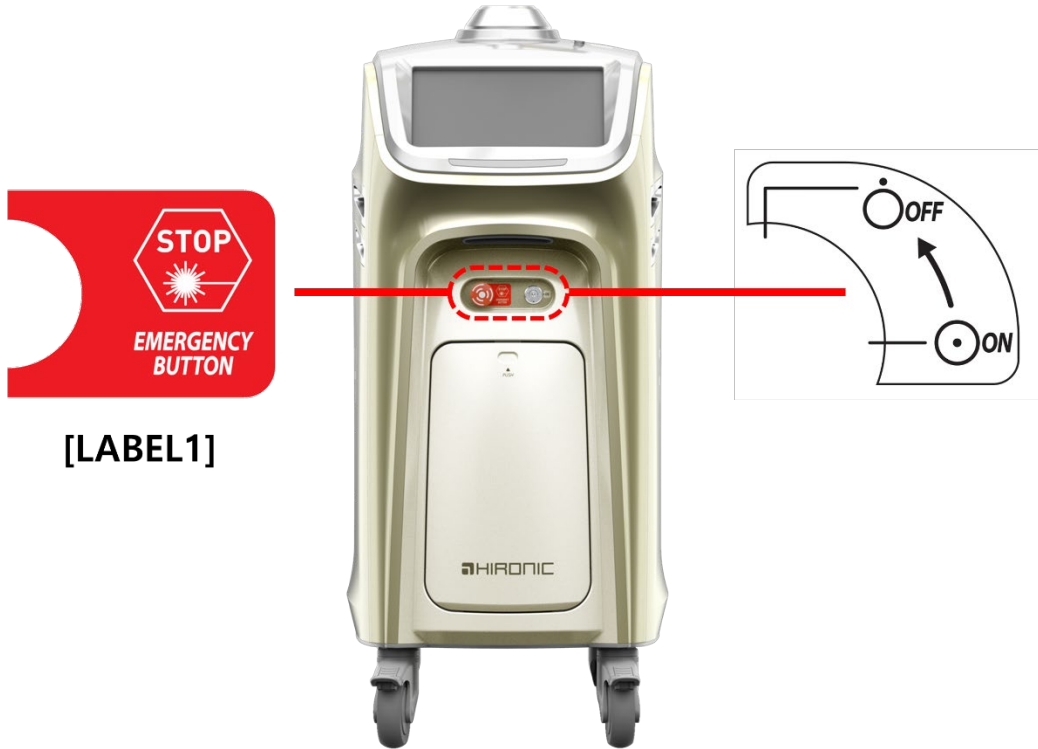

[LABEL 1]

### [Labels on the rear]

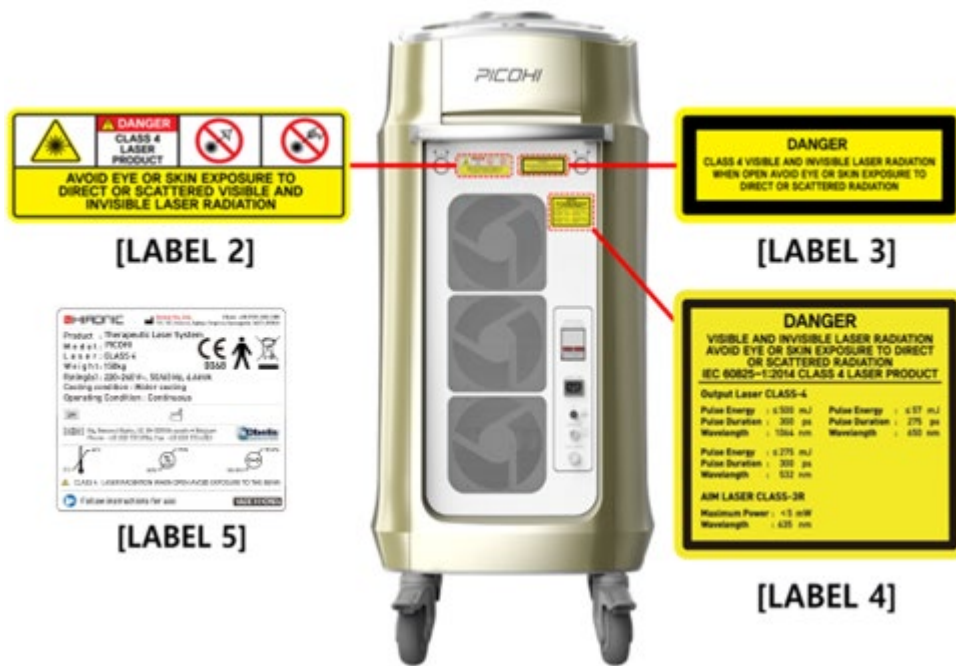

[LABEL 2]

[LABEL 3]

[LABEL 5]

[LABEL 4]

# Introduction

## [Laser output Label]

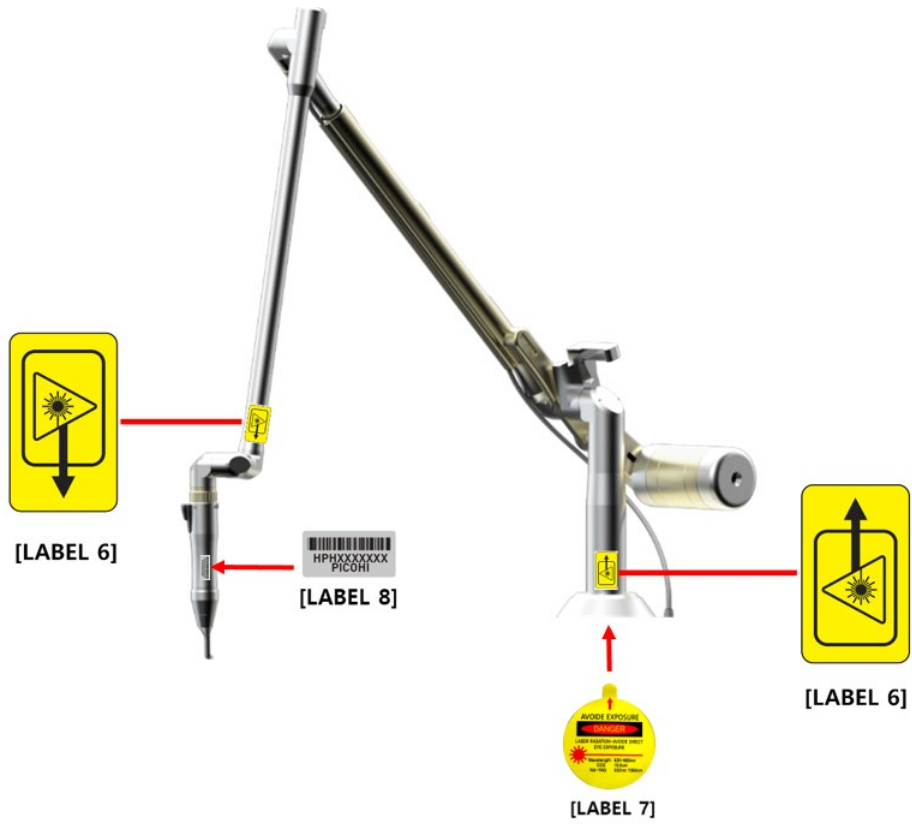

## [Upper side Label]



# Introduction

[BOX Label]



MODEL	
SN	
	<b>Hironic Co.,Ltd.</b> 19F U-TOWER, 767, Sinsu-ro, Suji-gu, Yongin-si, Gyeonggi-do, Korea TEL +82-31-525-7000 / FAX +82-31-525-7010 <a href="http://www.hironic.com">www.hironic.com</a>
etc.	

# 1. Product Overview & Components

## 1.1 Overview of PICOHI™

This product is an "Laser, Surgical, Nd:YAG" and composed of Nd:YAG which is a 1064 nm medium and solid-state laser and of KTP which is a 532 nm medium. The energy with wavelengths of 1064 nm and 532 nm, generated by a laser, is irradiated into cells or tissues of skin to increase temperature of the tissues due to the selective photothermolysis theory. Thermal energy is produced during this process, and the "Laser, Surgical, Nd:YAG" uses this thermal energy to incise, destruct and remove tissues. Dye laser surgery using a solid pigment as a medium is a laser surgery for cutting, destroying, and removing the tissue by the heat effect selectively absorbed into the tissue by using the characteristics of different absorption rate in the biological tissue.

### 1.1.1 Overview of PICOHI™ 300

#### 1.1.1.1 Electrical specifications

- A) Rated voltage/ frequency: 220-240 V ~, 20 A, 50/60 Hz
- B) Power consumption: < 4.4kVA

#### 1.1.1.2 Form and degree of protection for rating

- A) Form and degree of protection against electric shock: Class 1 device, Type B device
- B) Laser class based on IEC60825-1: Class 4

#### 1.1.1.3 Safety devices

No.	Device	Description
1	System lock	The wheel locks prevent physical impact on the system as well as vibration of the system.
2	Emergency switch	The user can use the emergency switch to cut off power to the system in an emergency situation.
3	Foot switch	The user can manually press the foot switch to prevent unusual operation.
4	READY and STANDBY buttons	These buttons are used to prevent unusual operation of the system. The user can configure settings so that these buttons become activated immediately before the foot switch is activated after configuring required settings.
5	Laser protective goggles	The user should wear laser protective goggles to prevent damage to their eyes.
6	Interlock	The system does not work if the interlock switch is not connected to the main unit.
7	Over current breaker	The over current breaker automatically cuts off current if over current occurs during operation of the system. To restart the system, simply raise the breaker handle.

#### 1.1.1.4. Mechanical specifications

##### Standard Component

- A) Main unit [W×D×H]: 457 x 1022 x 847 mm, 150Kg
- B) Articulated arm [H]: 892 mm
- C) Zoom Handpiece [D×H] : 203 mm x 45.5 mm
- D) Foot switch case [W×D×H]: 148 x 160 x 140 mm
- E) Foot switch [W×D×H]: 68 x 120 x 37 mm
- F) Interlock [D×H]: 28.6 x 14.5 mm
- G) User Goggles 1064 / 532 nm (for operator) [W×D×H]: 155 x 170 x 55 mm
- H) Patient goggles [W×H]: 117 x 30 mm
- I) Key switch [W×D]: 21 x 38 mm
- J) Power cable: 2 m

##### Optional Component

- A) Collimated Handpiece [D×H] : 195 mm x 45.5 mm
- B) VMLA Handpiece [D×H] : 164 mm x 45.5 mm
- C) ZMLA Handpiece [D×H] : 177 mm x 45.5 mm
- D) DOE 532 Handpiece [D×H] : 180 mm x 45.5 mm
- E) DOE 1064 Handpiece [D×H] : 180 mm x 45.5 mm
- F) DYE 650 Handpiece [D×H] : 230 mm x 45.5 mm
- G) User Goggles 650 nm (for operator) [W×D×H]: 146 x 145 x 50 mm

## 1.2 Product Performance

### 1.2.1 Performance of PICOHI™ 300 in detail (Basic Zoon / VMLA / Collimated Handpiece)

No.	Item	Details					
1	Irradiated beam	Medium	Nd:YAG (Neodymium-doped yttrium aluminum garnet)				
2		Beam profile	Super Hive Flat mode (top hat mode)				
3		Handpiece	ZOOM		VMLA		Collimated
4		Wavelength [nm]	1064	532	1064	532	1064
5		Output [mJ]	10~508	4~255	13~464	13~252	7~471
		※ Setting value of each spot size is different due to 0.01~1.0J/cm <sup>2</sup> step table of fluence for accuracy of laser output. Please refer to step table of fluence for details.					
6		Pulse width [ps]	300	275	300	275	300
7		Diameter of irradiation area (spot / mm)	2 ~ 10	1.5 ~ 7.5	13	13	10
8		Pulse repetition Rate [Hz]	1, 2, 5, 10 Hz				
9		Laser class	Class 4 laser				
10	Aiming beam	Medium	AlGaInP				
11		Wavelength	635 nm				
12		Output	Below 5 mW				
13		Laser class	Class 3R laser				
14	Cooling method	Water cooling					
15	NOHD	Spot size : 10 mm / Max 500 mJ	: 0.035m				
		Spot size : 2 mm / Max 500 mJ	: 31.68m				

※ The diameter area of the Zoom Handpiece can manually be adjusted.



#### NOTE

**Nominal Ocular Hazard Distance (N.O.H.D.)** This is the distance from the source at which the intensity or the energy per surface unit becomes lower than the Maximum Permissible Exposure (M.P.E.) on the cornea and on the skin.

### 1.2.2 Performance of PICOHI™ 300 in detail (ZMLA / DOE / DYE Handpiece)

No.	Item	Details					
1	Irradiated beam	Medium	Nd:YAG (Neodymium-doped yttrium aluminum garnet)				
2		Beam profile	Super Hive Flat mode (top hat mode)				
3		Handpiece	ZMLA		DOE		DYE
4		Wavelength [nm]	1064	532	1064	532	650
5		Output [mJ]	2~508	5~255	10~500	10~250	7~56
			※ Setting value of each spot size is different due to 0.01~1.0J/cm <sup>2</sup> step table of fluence for accuracy of laser output. Please refer to step table of fluence for details.				
6		Pulse width [ps]	300	275	300	275	300
7		Diameter of irradiation area (spot / mm)	4~12	4~12	10 x 10	10 x 10	3
8		Pulse repetition Rate [Hz]	Single 1, 2, 5, 10				
9	Laser class	Class 4 laser					
10	Aiming beam	Medium	AlGaInP				
11		Wavelength	635 nm				
12		Output	Below 5 mW				
13		Laser class	Class 3R laser				
14	Cooling method	Water cooling					
15	NOHD	Spot size : 10 mm / Max 500 mJ : 0.035m					
		Spot size : 2 mm / Max 500 mJ : 31.68m					

※ The diameter area of the ZMLA handpiece can manually be adjusted.



**NOTE**

**Nominal Ocular Hazard Distance (N.O.H.D.)** This is the distance from the source at which the intensity or the energy per surface unit becomes lower than the Maximum Permissible Exposure (M.P.E.) on the cornea and on the skin.

### 1.2.3 Step Table of Fluence

No.	Item	Details				
1	Medium	Nd:YAG (Neodymium-doped yttrium aluminum garnet)				
2	Beam profile	Super Hive Flat mode (top hat mode)				
3	Handpiece	ZOOM		VMLA		Collimated
4	Wavelength [nm]	1064	532	1064	532	1064
5	Irradiated beam Step Table of Fluence [J/cm <sup>2</sup> ]	0.02~0.20 (0.01)	0.01~0.20 (0.01) 0.20~1.00 (0.05)	0.01~0.20 (0.01) 0.20~0.35 (0.05)	0.01~0.19 (0.01)	0.01~0.20 (0.01) 0.20~0.60 (0.02)
		0.20~2.00 (0.1)	1.00~3.00 (0.1)			
		2.00~5.00 (0.2)	3.00~5.00 (0.2)			
		5.00~7.00 (0.5)	5.00~8.00 (1.0)			
		7.00~16.00 (1.0)	8.00~12.00 (0.5) 12.00~14.00 (1.0)			
6	Handpiece	ZMLA		DOE		DYE
7	Wavelength [nm]	1064	532	1064	532	650
8	Step Table of Fluence [J/cm <sup>2</sup> ]	0.01~0.20 (0.01) 0.20~3.00 (0.1)	0.01~0.20 (0.01) 0.20~1.00 (0.05) 1.00~2.00 (0.1)	0.01~0.20(0.01) 0.20~0.50(0.05)	0.01~0.25(0.01)	0.10~0.80 (0.1)

## 1.3 Components and Functions

### 1.3.1 Standard components of the product

PICOHI™ 300 is composed of the following components.

No.	Component	Quantity	Note
1	Main unit	1 EA	-
2	Articulated arm	1 EA	-
3	Zoom Handpiece	1 EA	-
4	Foot switch	1 EA	-
5	Interlock	1 EA	-
6	User Goggles	1 EA	-
7	Patient goggles	1 EA	-
8	Power cable	1 EA	-
9	User Manual	1 EA	-
10	Key switch	1 SET	-
11	Service Key	1 SET	-

1) Main Unit

2) Articulated arm



3) ZOOM Handpiece



4) Foot Switch



5) Interlock



6) User Goggles (532 nm, 1064 nm)



7) Patient Goggles



8) Power Cable



9) User Manual



10) Key Switch



11) Service Key



No.	Component	Quantity	Note
12	<b>User Goggles (650 nm)</b>		Optional
13	<b>Collimated Handpiece</b>		Optional
14	<b>VMLA Handpiece</b>		Optional
15	<b>Zmla Handpiece</b>		Optional
16	<b>DYE 650 HAndpiece</b>		Optional
17	<b>DOE 532 Handpiece</b>		Optional
18	<b>DOE 1064 HAndpiece</b>		Optional

**12) User Goggles (650 nm)**



**13) Collimated Handpiece**



**14) VMLA Handpiece**



**15) ZMLA Handpiece**



**16) DYE 650 Handpiece**



**17) DOE 532 Handpiece**



**18) DOE 1064 Handpiece**



## 1.3.2 Names and functions of components

### 1.3.2.1 Main unit—front view

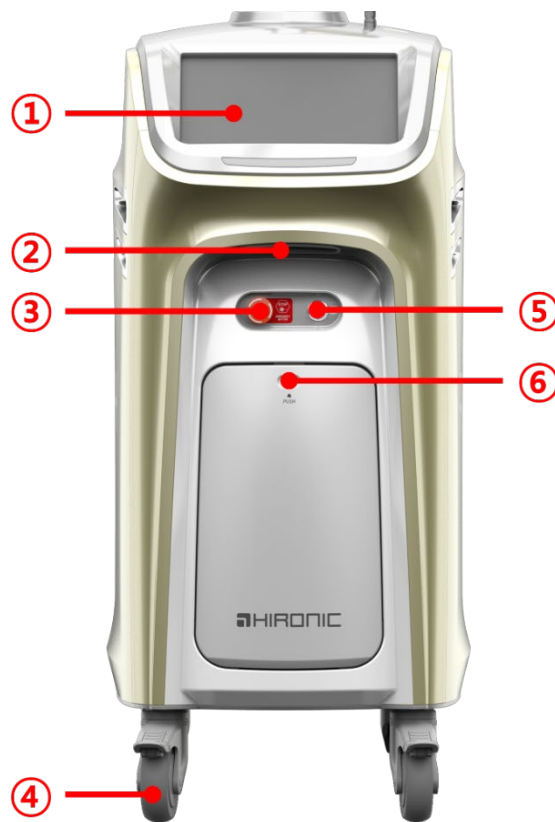

No.	Item name	Description
1	<b>Display unit (Touch Screen)</b>	Use the display unit to view the system status and configure parameter values.
2	<b>Handle (on the front)</b>	Hold this handle when moving the system.
3	<b>Emergency switch</b>	Press this stop button to immediately stop operation of the system if necessary for any reason, e.g. incorrect operation of the system.
4	<b>Wheels</b>	The wheels allow you to easily move the system. Use the locks on the wheels to anchor or store the system in a stable position.
5	<b>Key switch</b>	The system can only operate when the key switch is on. The key cannot be removed when the system is operating.
6	<b>Locker Push Button</b>	Press the button to open the handpiece locker and use distilled water inlet.

### 1.3.2.2 Main unit—rear view

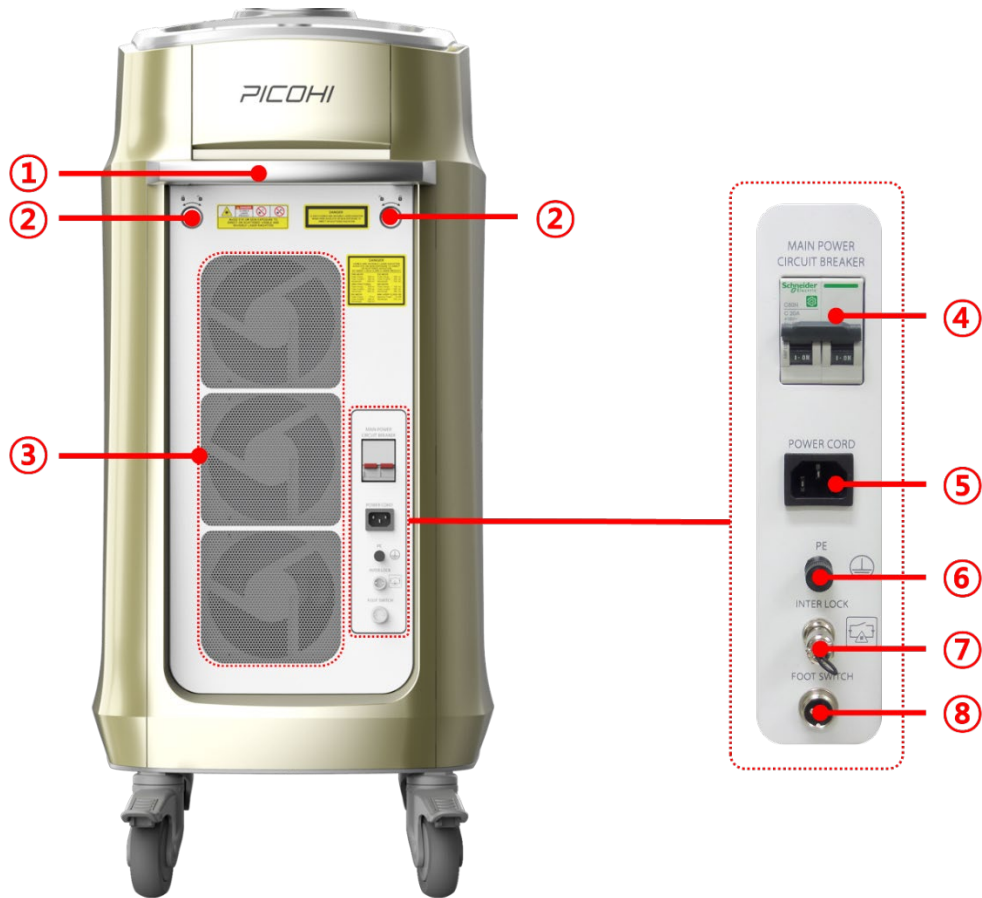

No.	Item name	Description
1	Handle (on the rear)	Hold this handle when moving the system.
2	Service lock	The rear/side covers of the system can be removed for servicing of the interior of the system. To remove the covers, first use the key to turn off the system.
3	Air vent	Heat inside the system is discharged through this hole to the outside.
4	Power switch	Use this switch to connect/disconnect the external power supply.
5	Power port	Use this port to connect an external power cable to the main unit.
6	Ground port	This port on the system is provided for external grounding.
7	Interlock port	The system does not work if the interlock switch is not connected to the main unit.
8	Foot switch port	Use this port to connect the foot switch to the main unit for system operation

### 1.3.2.3 Main unit—top view

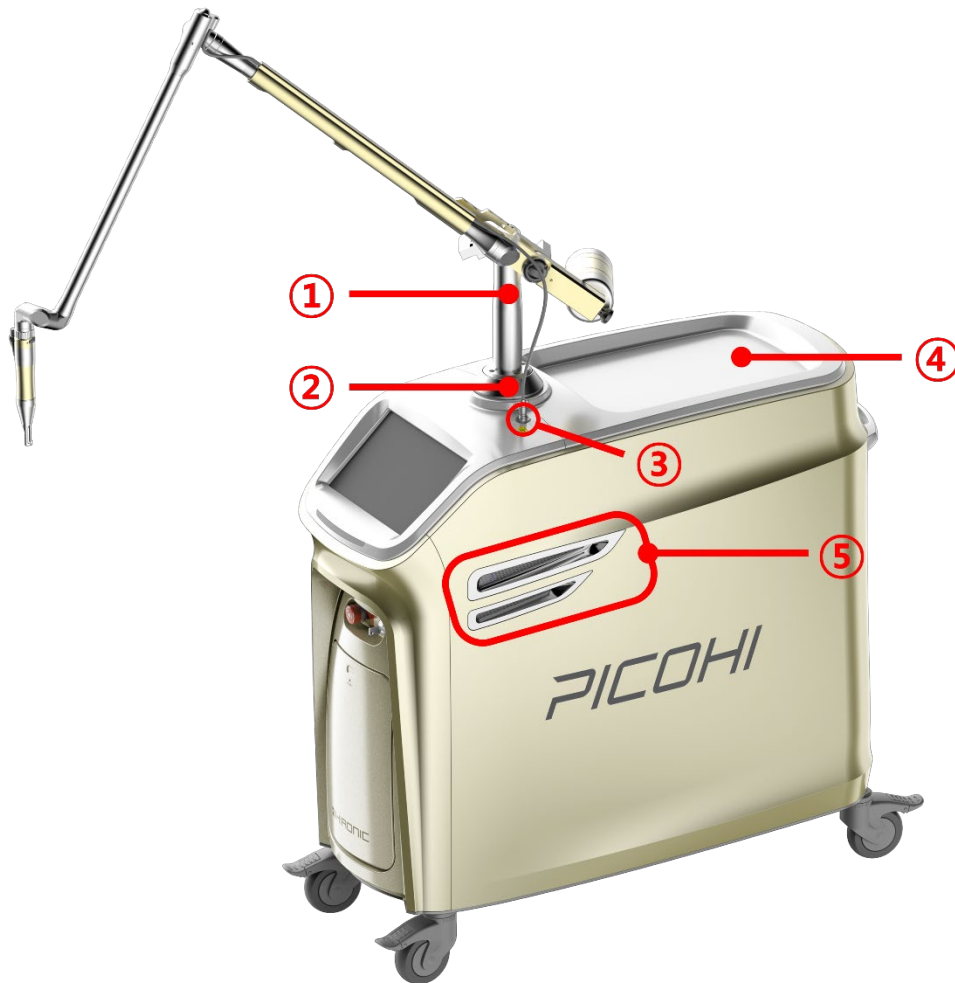

No.	Item name	Description
1	<b>Articulated arm unit stand</b>	This pole props up the articulated arm.
2	<b>Articulated arm unit connector</b>	The articulated arm connects to the main unit via this connector.
3	<b>Aiming beam and spot size adjustment cable connector</b>	The laser handpiece cable connects to the main unit via this connector.
4	<b>Storage tray on top</b>	Store components not in use or the user manual in this tray.
5	<b>Air intake</b>	Intake part to suck air



**Caution**

**The air intake is not a handle. Please be careful.**

### 1.3.2.4 Articulated arm and handpiece

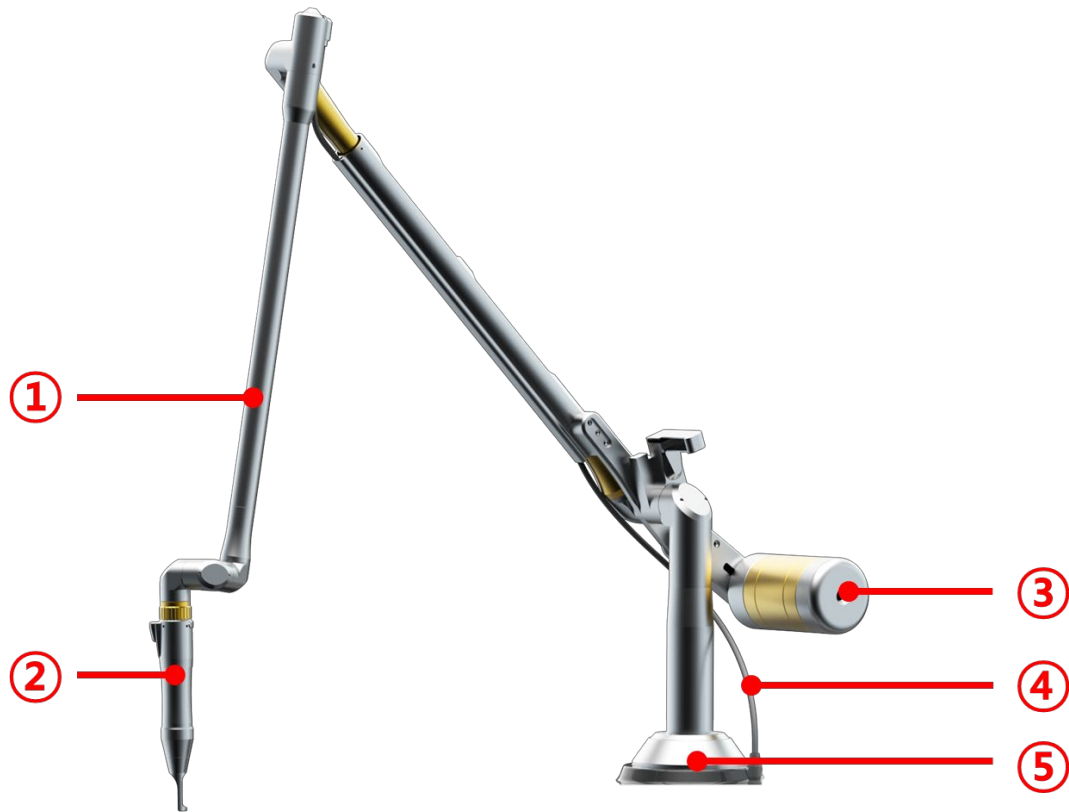

No.	Item name	Description
1	<b>Articulated arm connection pipe</b>	This laser beam passage connects between the optical head and the handpiece.
2	<b>Handpiece</b>	This handpiece is used with PICOHI™ 300 and can be connected to the articulated arm.
3	<b>Balance weight</b>	This instrument keeps the articulated arm balanced.
4	<b>Aiming beam and spot size adjustment cable</b>	Used to supply power to the aiming beam of the handpiece and recognize the spot size of the handpiece.
5	<b>Main unit connector</b>	The main unit connects to the articulated arm via this connector.

### 1.3.2.5 Zoom Handpiece

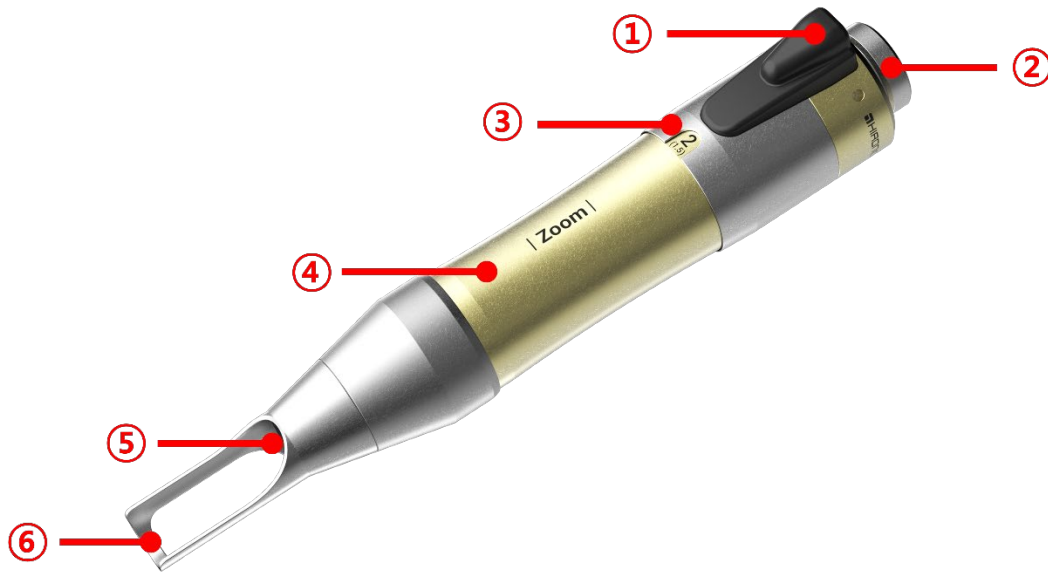

No.	Item name	Description
1	<b>Aiming beam and spot size adjustment cable connector</b>	Used to supply power to the aiming beam of the handpiece and recognize the spot size of the handpiece.
2	<b>Handpiece connector</b>	The handpiece connects to the articulated arm via this connector.
3	<b>Spot size adjuster</b>	Use this adjuster to adjust spot size. (Spot size can be adjusted by pulling the adjuster with hand.)
4	<b>Handpiece body</b>	Give treatment by gripping this handpiece body.
5	<b>Output port</b>	Aiming beam or laser beam is irradiated through this port.
6	<b>Handpiece tip</b>	This tip is used as a guide for accurate treatment with laser radiation.

### 1.3.2.6 Foot switch (IPX Level : IP 54)



No.	Item name	Description
1	<b>Exterior cover</b>	This cover/guide prevents the foot switch from being pressed when it has overturned.
2	<b>Foot switch</b>	This switch is equipped with an embedded contact switch which causes energy irradiation when the foot switch is pressed.
3	<b>Connection cable</b>	This cable transmits foot switch position signals to the main unit.
4	<b>Foot switch connector</b>	This connector connects to the foot switch port in the bottom rear of the system.

### 1.3.2.7 Interlock

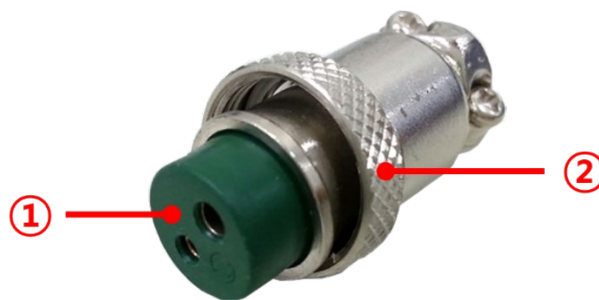

No.	Item name	Description
1	<b>Connection pin</b>	This pin is inserted into the interlock port in the bottom rear of the main unit.
2	<b>Locking device</b>	This locking device with a thread structure is used to lock the interlock.

### 1.3.2.8 User goggles (532, 1064 nm)



No.	Item name	Description
1	<b>User goggles</b>	Used for purpose of protecting the operator from laser radiation when the system is in use. Laser type: Nd:YAG Visible light transmittance (VLT) > 30% Certification by European Norms (CE): EN 207:2009 + AC:2011 Applied wavelength (nm): 190–540 / 800–1700 Optical density (O.D) >4, >5, >6 CE-EN207 L-Rating :

### 1.3.2.9 Patient goggles



No.	Item name	Description
1	<b>Patient goggles</b>	Used for purpose of protecting the patient from laser radiation when the system is in use (YL-800W, CE certified) Color: White Material: Plastic

### 1.3.2.10 Power cable



No.	Item name	Description
1	<b>Power cable</b>	This cable connects to the rear bottom of the main unit to supply external power to the main unit.

### 1.3.2.11 User manual



No.	Item name	Description
1	User manual	Product user's manual

### 1.3.2.12 Key switch



No.	Item name	Description
1	Key switch	The system can only operate when the key is inserted and positioned ON in the keyhole in the top front of the system.

### 1.3.2.13 Door lock Key



No.	Item name	Description
1	Door lock Key	To maintain the main body of the device, insert the key into the lock located on the external cover with the corresponding key to remove the external device.

### 1.3.2.14 User goggles 650 nm



No.	Item name	Description
1	<b>User goggles</b>	Used for purpose of protecting the operator from laser radiation when the system is in use. Display Wavelength (nm) / OD 190-400 5+ / 580-595 5+ / 585 6+ 645-670 5+ / 650-665 6+ VLT : 14% CE Rating 580-590 + 645-670 DIR LB5 585 + 650-665 D LB5 + IR LB6

### 1.3.2.15 Collimated Handpiece

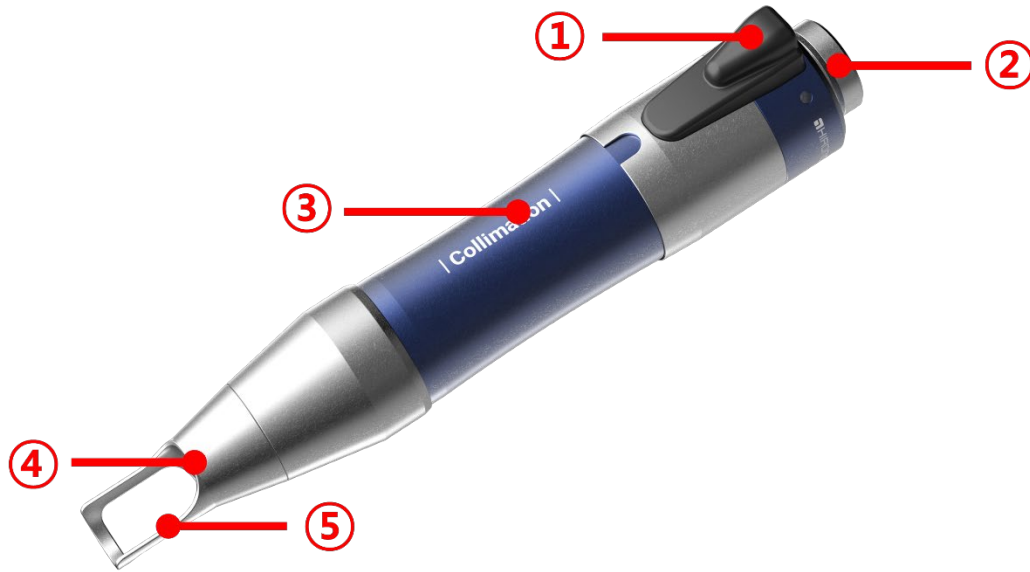

No.	Item name	Description
1	<b>Aiming beam and spot size adjustment cable connector</b>	Used to supply power to the aiming beam of the handpiece and recognize the spot size of the handpiece.
2	<b>Handpiece connector</b>	The handpiece connects to the articulated arm via this connector.
3	<b>Handpiece body</b>	Give treatment by gripping this handpiece body.
4	<b>Output port</b>	Aiming beam or laser beam is irradiated through this port.
5	<b>Handpiece tip</b>	This tip is used as a guide for accurate treatment with laser radiation.

### 1.3.2.16 VMLA Handpiece (1064 & 532nm Variable Micro Lens Array Handpiece)



No.	Item name	Description
1	Aiming beam and spot size recognition cable connector	Used to supply power to the aiming beam of the handpiece and recognize the spot size of the handpiece.
2	Handpiece connector	The handpiece connects to the articulated arm via this connector.
3	Handpiece body	Give treatment by gripping this handpiece body.
4	Lens distance control	Use to regulate the depth irradiated to the skin (0mm, 0.5mm, 1mm, 1.5mm adjustable in 4 steps)
5	Output port	Aiming beam or laser beam is irradiated through this port.
6	Handpiece tip	This tip is used as a guide for accurate treatment with laser radiation.

### 1.3.2.17 ZMLA Handpiece (1064 & 532 nm Zoom Micro Lens Array Handpiece)



No.	Item name	Description
1	Aiming beam and spot size adjustment cable connector	Used to supply power to the aiming beam of the handpiece and recognize the spot size of the handpiece.
2	Handpiece connector	The handpiece connects to the articulated arm via this connector.
3	Spot size adjuster	Use this adjuster to adjust spot size. (Spot size can be adjusted by pulling the adjuster with hand.)
4	Handpiece body	Give treatment by gripping this handpiece body.
5	Output port	Aiming beam or laser beam is irradiated through this port.
6	Handpiece tip	This tip is used as a guide for accurate treatment with laser radiation.

### 1.3.2.18 DYE 650 Handpiece

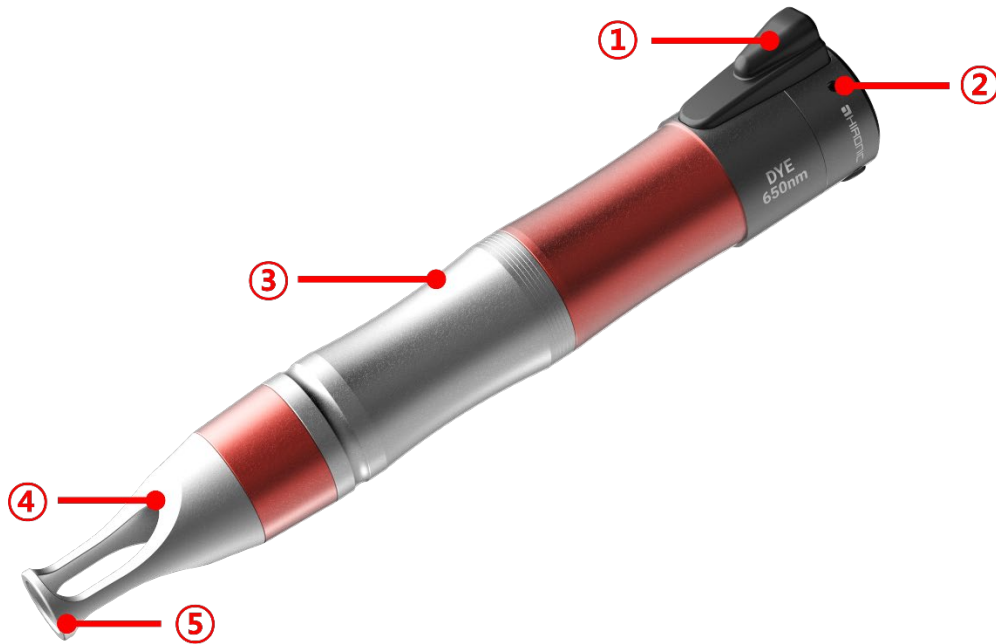

No.	Item name	Description
1	Aiming beam and spot size recognition cable connector	Used to supply power to the aiming beam of the handpiece and recognize the spot size of the handpiece.
2	Handpiece connector	The handpiece connects to the articulated arm via this connector.
3	Handpiece body	Give treatment by gripping this handpiece body.
4	Output port	Aiming beam or laser beam is irradiated through this port.
5	Handpiece tip	This tip is used as a guide for accurate treatment with laser radiation.

### 1.3.2.19 532 DOE Handpiece (532nm, Diffractive Optical Element Handpiece)

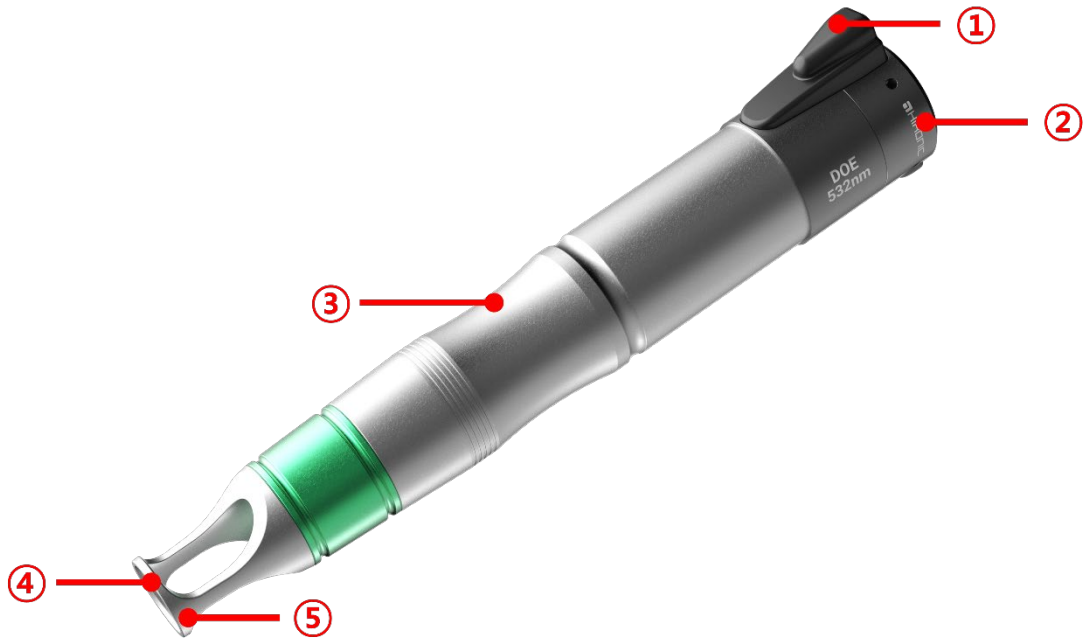

No.	Item name	Description
1	<b>Aiming beam and spot size recognition cable connector</b>	Used to supply power to the aiming beam of the handpiece and recognize the spot size of the handpiece.
2	<b>Handpiece connector</b>	The handpiece connects to the articulated arm via this connector.
3	<b>Handpiece body</b>	Give treatment by gripping this handpiece body.
4	<b>Output port</b>	Aiming beam or laser beam is irradiated through this port.
5	<b>Handpiece tip</b>	This tip is used as a guide for accurate treatment with laser radiation.

### 1.3.2.20 DOE 1064 Handpiece (1064nm, Diffractive Optical Element Handpiece)

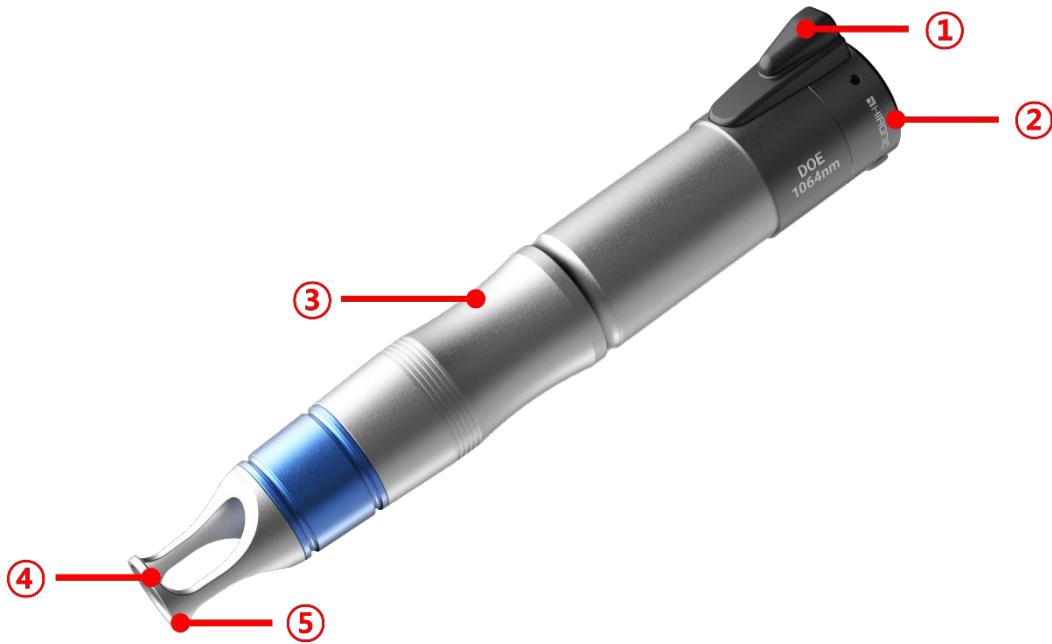

No.	Item name	Description
1	<b>Aiming beam and spot size recognition cable connector</b>	Used to supply power to the aiming beam of the handpiece and recognize the spot size of the handpiece.
2	<b>Handpiece connector</b>	The handpiece connects to the articulated arm via this connector.
3	<b>Handpiece body</b>	Give treatment by gripping this handpiece body.
4	<b>Output port</b>	Aiming beam or laser beam is irradiated through this port.
5	<b>Handpiece tip</b>	This tip is used as a guide for accurate treatment with laser radiation.

### 1.3.2.21 Software

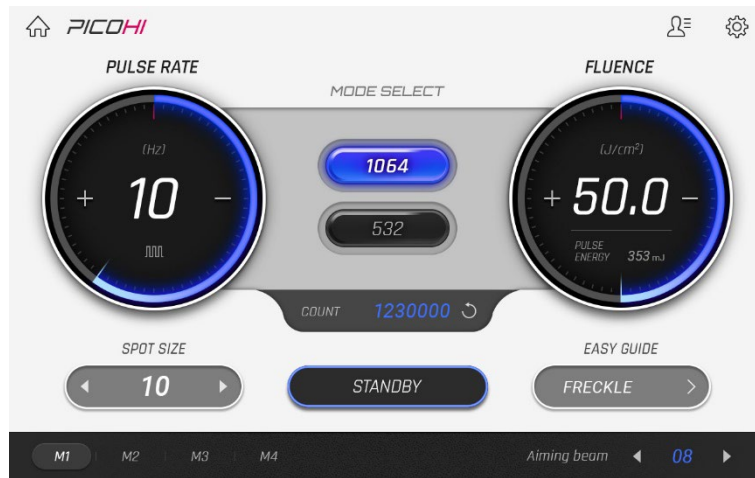

No.	Item name	Description
1	<b>PICOHI™ 300 Operating software</b>	Function: The software is used to configure/manipulate laser functions and view the system status and settings.



**Caution**

**Direct exposure of eye to laser beam may cause loss of sight. Make sure you wear protective goggles before using the system.**

## 2. General Safety

---

### 2.1 Checklist before Use

#### 2.1.1 Checklist before Use.

- \* Avoid a location that is humid or exposed to water.
- \* Locate the product in a location where the product will not be damaged by excessive air pressure, temperature extremes, humidity, lack of ventilation, direct sunlight, dust, salt, or air containing ions.
- \* Locate the product in a safe location with no slope, vibration and impact.
- \* Avoid a location where chemicals are stored or gases are generated.
- \* Pay attention to the power frequency, voltage and allowable current (or power consumption).
- \* Check the status of grounded power supply.

#### 2.1.2 To move the product to another place, follow the steps below.

- \* First turn off the system and remove the power cable.
- \* Securely fixate the Articulated arm so that it cannot fall down.
- \* Raise all the brakes on the wheels so that the wheels can roll.
- \* Slowly move the system by holding either transport handle on the main unit.
- \* Exercise caution to ensure that the Articulated arm does not collide with other objects.
- \* After the moving is finished, lower the brakes on the wheels to anchor the product.
- \* To transport the product over a long distance and long period of time, separate the Articulated arm and use a laser sealing material to cover the laser output port on the main unit.



#### Caution

Use caution to minimize impact applied to the product when moving it.



#### NOTE

To move the product with the Articulated arm separated, use laser sealing material or a dedicated cover to seal up the connector between the main unit and the arm.

## 2.2 Preparations before Location

### 2.2.1 Checking the grounding status

- \* Make sure that the power plug is correctly connected. Do not attempt to connect the power cord to the product wet hands. There is a risk of electric shock.

#### Checking the [power cable] grounding status



[Cable grounding position]



[Electrical outlet grounding position]



[Correctly connected]

- \* Plug the power cable all the way into the electrical outlet to ensure proper grounding. Incorrect connection may cause incorrect grounding on the connector. As a result, input into the front touch panel may not work properly or the product may malfunction.

#### [Power ON / OFF] Using the main power switch circuit breaker on the rear of the system



[Circuit breaker ON]



[Circuit breaker OFF]

- \* The PICOHI™ 300 system is not equipped with a fuse
- \* The PICOHI™ 300 system is equipped with an automatic circuit breaker (no fuse breaker) which automatically cuts off current if allowable current is exceeded.



#### NOTE

- \* **The system may not turn on if the power cable is not fully plugged in.**
- \* **The system may malfunction if it is used in an environment where grounding is not possible.**
- \* **PICOHI™ 300 is designed by 220 ~ 230V, 50/60 Hz, Please do not use other than the suggested power rating. If the voltage provided by the local supply is not within the range accepted suggested range, Please contact Hironic Co., Ltd. technician.**

## Handpiece cable arrangement



[Good]



[Bad]

- \* Make sure the handpiece cable is not tangled.
- \* Make sure the cable is neither tangled nor loose.

## Articulated arm cable arrangement



[Good]



[Bad]



### Caution

If the handpiece cable is tangled, the cable may become damaged. If the cable is damaged, data cannot be sent properly from the handpiece to the main unit. This may seriously affect the patient.

## 3. How to Use

### 3.1 Preparations before Use

- \* To use the system, first secure an location space.
- Avoid a location where strong electricity or a magnetic field is running or a location that can be exposed to heat or moisture. The system may malfunction or break down.
- Locate the system where proper temperature and humidity can be maintained. Ensure that the interior temperature and humidity of the place where the system is located are maintained between 10 and 30°C and between 30 and 70%.
- Ensure that the system's vent is at least 30 cm away from the walls.
- locate the product on a stable and flat surface.
- \* Check that the handpiece has properly been cleaned using an antiseptic solution (e.g. alcohol) before use.
- Check that the handpiece tip is not damaged.
- Check that the handpiece tip lens is not damaged. (Contact Hironic Co., Ltd. if the handpiece tip lens is damaged.)
- \* Check that all components necessary for treatment, such as the handpiece, articulated arm and foot switch, are properly connected to the main unit before use.
- Connect every component of the system.
- Connect the external ground port to the external earth ground.
- Connect the power cable to a grounded wall outlet.
- \* Make sure all people, including the doctor, in the space where the system is used wear protective goggles appropriate for the wavelength in use, before using the system.

### 3.2 Using the Product

- \* After all the components are connected, use the following steps to apply power to the system.
- Position the power switch (circuit breaker), located in the bottom rear of the system, to ON.
- Position the key switch on top of the system to ON.
- \* Checking for system failure
- Press the emergency switch to check if the system works properly.
- Remove the interlock to check if the system works properly.
- \* Precautions for operator's safety
- Operators should wear protective goggles to ensure safety from laser radiation.
- \* Device booting and initialization
- If all components, including the handpiece, are properly connected and power is applied, the system performs initialization and checks the connection of the components.



#### Caution



**Do not directly stare into the laser beam when being irradiated. Make sure you wear protective goggles before using the product. If laser is irradiated directly to eyes, there is a risk of loss of sight.**

## Assembling the articulated arm

1. Have ready the articulated arm and main unit.



Main unit



Articulated arm

2. Remove the "Danger" label sticker from the Articulated arm connector on the bottom of the articulated arm.  
3. Remove the laser sealing label sticker from the articulated arm connector on top of the main unit.

Label sticker on bottom  
of articulated armLabel sticker on top of  
main unit

4. Place the Articulated arm connector on the area where the articulated arm will be connected on top of the main unit.  
5. Align the articulated arm with the triangular "Front" mark on the Articulated arm.  
Use the 4 articulated arm screws to fixate the articulated arm.  
7. Turn the screws clockwise with a hex wrench to tightly fasten the screws.



4.

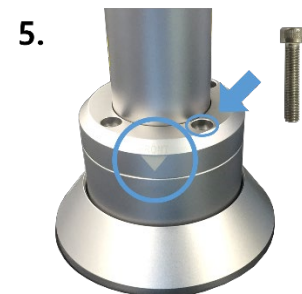

5.



Articulated arm screws



6.

Assembling of articulated arm



### Caution

**To connect or remove the arm, contact an authorized technician. Do not attempt to connect or remove it by yourself.**

7. To lift up the Balance weight, turn its screw counterclockwise.

※ To go down the Balance Weight turn its screw counterclockwise.

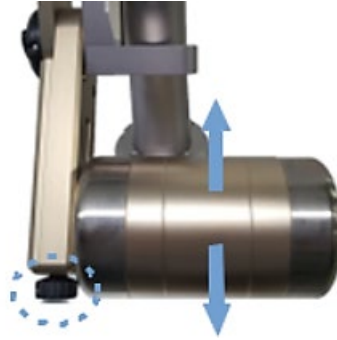

8. Turn the articulated arm adjustment screw counterclockwise to find the point where the adjustment screw engages.



9. When you find the point where it is stuck, support the Balance weight with your hand and press the adjustment screw. You can adjust the slope of the articulated arm step by step while pressing. (Steps 1-6)

※ Turn the adjustment screw clockwise until the slope is fixed.



How to adjust the slope of the articulated arm



### Caution

**To connect or remove the arm, contact an authorized technician. Do not attempt to connect or remove it by yourself.**

## Connecting the handpiece

1. Have ready the handpiece.
2. Remove the handpiece cover.



Handpiece



Remove Cover

3. Check where to connect the handpiece on the articulated arm.



Position to which the handpiece should connect

4. Connect the handpiece to the handpiece connector on the articulated arm.



5. Connect the handpiece to the handpiece connection.



6. Rotate the handpiece connection up to connect the handpiece.

- ※ Turn the handpiece connection downward to detach the handpiece.



## Connecting the handpiece

7. Connect the handpiece to the articulated arm.



8. Connect the handpiece cable.



Cable connection direction

Connection of handpiece cable

9. Connect the cable of the articulated arm to the socket on the main unit.



Handpiece cable socket on main unit

Connection of handpiece cable



### Caution

**If you forcibly connect the handpiece cable socket to the articulated handpiece cable connection location, the handpiece cable socket may break.**

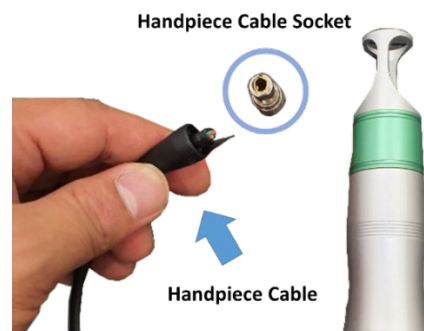

## Connecting the stopper

1. Have ready the stopper and one connection screw.



Stopper



Connection screw

2. Check where to connect the stopper.

3. Connect the stopper to the connector on the articulated arm.

Connection step 1:  
Connect the stopper and position it in place with hand.

Connection step 2:  
Use the connection screw to tightly fixate the stopper.

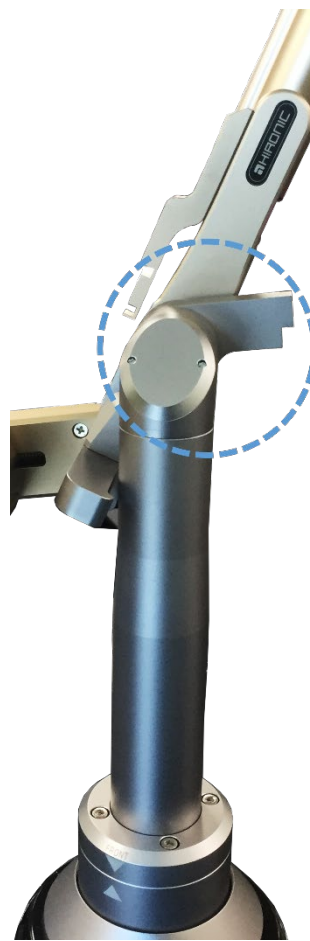

Connection position



Connection step 1

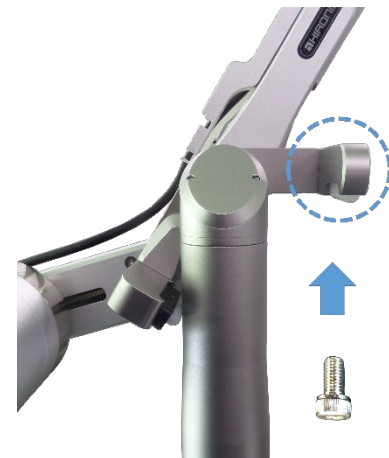

Connection step 2

## Adjusting the spot size

1. Check the position of the spot size adjuster on the handpiece.



Handpiece connector



Spot size adjuster

2. Pull and turn the spot size adjuster with hand.
3. Select the preferred spot size.



Position of spot size adjuster



Spot size adjuster (Pull it for size adjustment)



Spot size adjuster (Turn it to adjust the size)



Fixed the spot size adjuster

The spot size displayed on the screen is automatically updated each time the handpiece spot size is adjusted.

※ **Size of irradiation area by handpiece type**

ZOOM H/P 1064nm	: 2 to 10 mm
ZOOM H/P 532nm	: 1.5 to 7.5 mm
ZMLA H/P	: 4 to 12 mm

※ **H/P Mode Manual Mode (Settings)**

If the GUI screen does not automatically update the handpiece spot size although the spot size has been adjusted, it is possible to manually adjust the displayed spot size by turning on the manual mode under H/P Mode in Settings. (This action only changes the value on the screen. The actual handpiece spot size is not adjusted.)

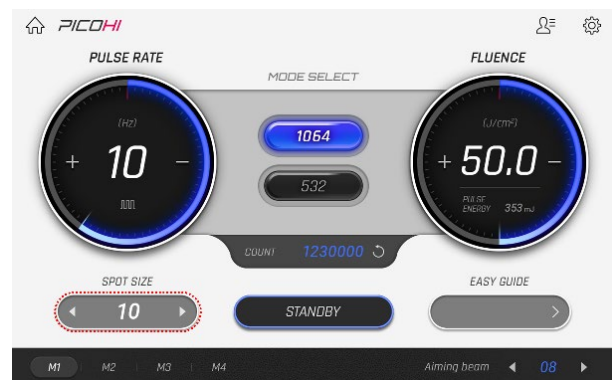

[GUI screen]

## Replacing the handpiece tip

The handpiece tip on PICOHI™ 300 is a consumable item that is replaceable. If the handpiece lens is discolored, blurry or damaged, please contact the Hironic Co., Ltd. after-sales service center.

1. Have ready the handpiece.
2. Turn the handpiece tip counterclockwise.



Handpiece



Removing the handpiece tip

3. Separate the handpiece tip from the handpiece.
4. Replace the old tip with the new one.



Separation of handpiece tip



Handpiece tip



### Caution

**Handpieces are consumable items. If PICOHI™ 300 is used for a long period of time, the handpiece lens may become damaged. Use caution to ensure that the lens is not damaged.**

## Locking/unlocking the wheels

The main unit of PICOHI™ 300 is equipped with four wheels that have locks.

These wheels are designed to stop rolling if the locks are engaged.

Make sure you engage the wheel locks before using the system to prevent the system from moving during treatment with laser radiation.

### [Engaging locks]

Step on each lock. The lock lever will descend to lock and prevent the wheel from rolling.

### [Disengaging locks]

Raise each lock lever. The wheel will be unlocked and can roll.

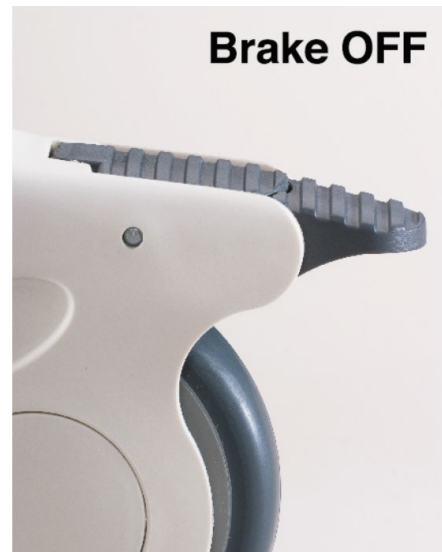

[Locked]

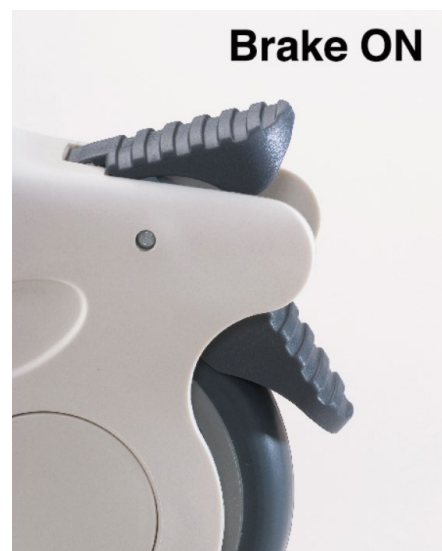

[Unlocked]



### Caution

**Make sure you lock the wheels before using the system to prevent the system from moving during treatment with laser radiation.**



### Caution

**If wheel locks are engaged with excessive force or engaged in an incorrect direction, the locks may become damaged.**

## Key switch button

PICOHI™ 300 is equipped with a key switch button on the front of the main unit.

PICOHI™ 300 only operates when the power switch on the rear of the system is on and the key switch on the front of the system is on.



Position of key switch

1. To turn on the system, turn the key switch clockwise.



[Key switch ON]

2. To turn off the system, turn the key switch counterclockwise.

※ If the emergency stop button is held down, the system will not operate even if the key switch is turned on.

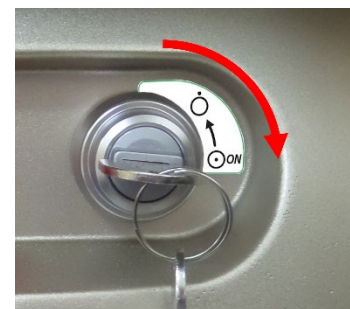

[Key switch OFF]



### NOTE

**Ensure that the key switch is never lost. There is no way to operate PICOHI™ 300 without the key switch.**

## Emergency Laser Stop Button

PICOHI™ 300 is equipped with an emergency laser stop button on the front of the main unit.

The Emergency Laser Stop button on the front of PICOHI™ 300 is designed to immediately stop operation of the system in an emergency situation.



**Emergency  
Laser  
Stop  
Button**

[Emergency Laser Stop button]

1. If the Emergency Laser Stop button is pressed, all functions of PICOHI™ 300 immediately stop.



[Pressed Stop button]

2. To resume operation of PICOHI™ 300 after the Emergency Laser Stop button has been pressed, turn the button in the arrow direction to reset the Emergency Laser Stop mode.

※ PICOHI™ 300 does not operate if Emergency Laser Stop mode is on.



[Stop button in original position]



### Caution

**Emergency Laser Stop button is used to immediately stop operation of the system when an emergency situation occurs.**

### 3.3 Using the Product Screen

#### \* Initialization screen

- As soon as power is supplied to the system, the system automatically starts initialization.
- The screen displays the manufacturer's logo and the product's model name.



[Initialization screen – 1]

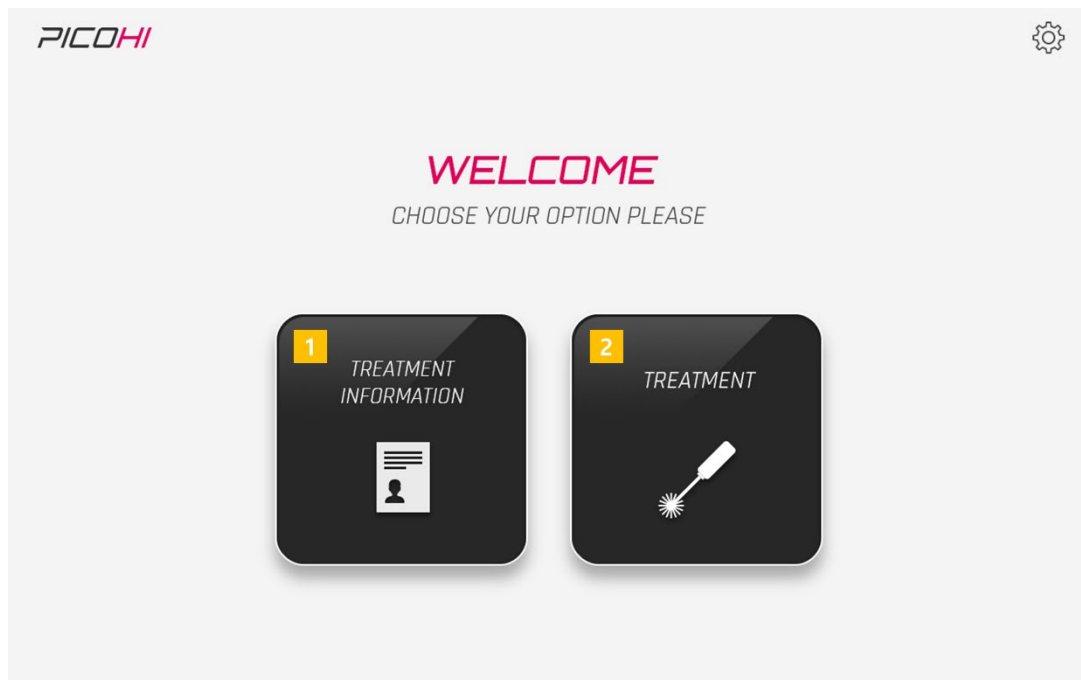

[Initialization screen – 2]

\* **TREATMENT selection screen**

No.	Name	Function
1	<b>TREATMENT INFORMATION</b>	Displays the user information selection screen.
2	<b>TREATMENT</b>	Displays the TREATMENT screen.

\* **TREATMENT INFORMATION - TREATMENT HISTORY**

- If you select the patient information, the procedure history information is displayed. If you click Back, the screen returns to the previous screen.
- If you click STATISTICS, you can check Treatment History Statistics chart details. If you select Treatment, you will be converted to the procedure screen.

**TREATMENT INFORMATION**

Treatment history | Patients information

Hand piece: ALL | **Zoom** | Colli- | MLA | DOE | DYE

Mode: 532 | Period: 1 year | Lesion: All | Feedback: All

TIME	HP	MODE	FLUENCE	RATE	SPOT	SHOT	LESION	FB
07.23.18 12:05	Zoom	532	50.0	10	10	10000	Freckle	☹️
05.20.18 14:32	Zoom	532	40.0	8	8	10000	Tanning	☹️
02.28.18 10:24	Zoom	532	35.0	6	6	5000	Tattoo	☹️
07.23.18 12:05	Zoom	532	50.0	8	8	8000	Letigo	😊
05.20.18 14:32	Zoom	532	40.0	10	10	10000	PIH	😊
02.28.18 10:24	Zoom	532	35.0	7	7	10000	Freckle	😊
07.23.18 12:05	Zoom	532	50.0	6	6	10000	None	😊
05.20.18 14:32	Zoom	532	40.0	6	6	5000	Tattoo	☹️

STATISTICS | TREATMENT

\* **TREATMENT HISTORY (STATICS)**

- Display TREATMENT HISTORY in chart by clicking STATISTICS button.

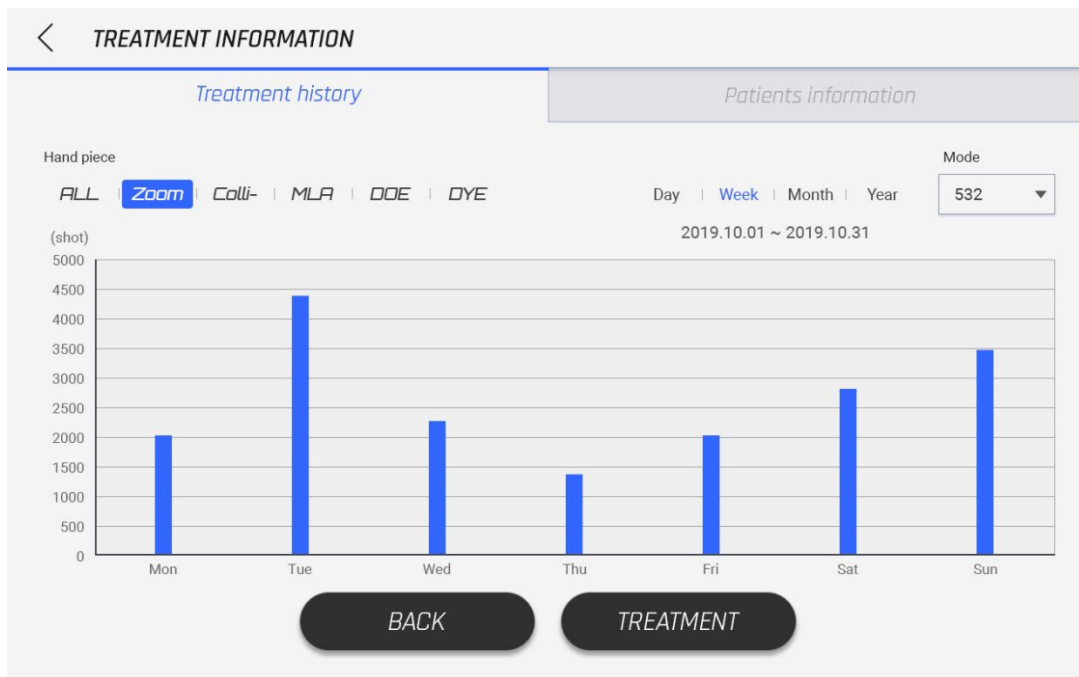

\* **PATIENT INFORMATION**

1 TREATMENT INFORMATION

2 Q 3 ↻

4 Treatment history

5 Patients information

6 Name TEXTTEXTTEXTTEXTTEXT X

7 Gender  Female  Male

8 Birthday Month 00 Day 00 Year 0000

9 Skin type I II III IV V VI

10 Height 160 cm

11 Weight 60 kg

12 BMI 28.53

13 SKIP

14 DONE

No.	Name	Function
1	<b>PATIENT INFORMATION</b>	Shows patient information.
2	<b>SEARCH</b>	Search for a specific patient.
3	<b>RESET</b>	Reset information that has been entered.
4	<b>TREATMENT INFORMATION</b>	The patient information entered can be checked.
5	<b>PATIENT INFORMATION</b>	Move to patient information field.
6	<b>NAME</b>	Enter the patient's name.
7	<b>GENDER</b>	Enter the patient's gender.
8	<b>BIRTHDAY</b>	Enter the patient's date of birthday.
9	<b>SKIN COLOR</b>	Enter the patient's skin tone.
10	<b>HEIGHT</b>	Enter the patient's height.
11	<b>WEIGHT</b>	Enter the patient's weight.
12	<b>BMI</b>	Shows the patient's BMI information.
13	<b>SKIP</b>	Skips the settings screen.
14	<b>DONE</b>	Select this button after entering information is completed.

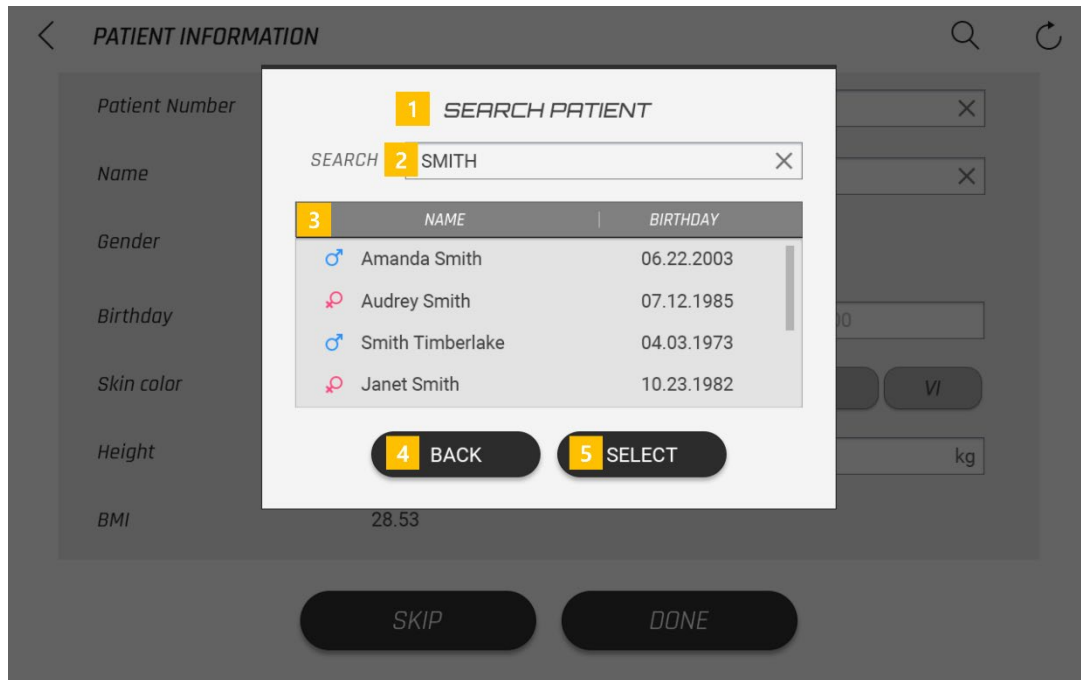
\* **SEARCH PATIENT**

No.	Name	Function
1	<b>SEARCH PATIENT</b>	Displays the PATIENT INFORMATION menu.
2	<b>SEARCH</b>	Enter a name or date of birth in YYYYMMDD format.
3	<b>SEARCH LIST</b>	Shows the result value (patient list) that meets the condition in SEARCH
4	<b>BACK</b>	Displays the previous screen.
5	<b>SELECT</b>	Select a retrieved patient.

### \* TREATMENT HISTORY

- If a patient is selected, the patient's treatment history is displayed. To go to the previous screen, press "Back." To go to the treatment screen, select "Treatment."

The screenshot shows the 'TREATMENT INFORMATION' screen. At the top, there is a back arrow and the title 'TREATMENT INFORMATION'. Below this, there are two tabs: 'Treatment history' (selected) and 'Patients information'. Under 'Treatment history', it shows '6nd Visit' and 'JANETE SMITH'. To the right, patient details are listed: Age 25, BMI 28.53, Skin Color 4. There are three numbered buttons: '1 Feedback', '2' (with a person icon), and '3' (with a person icon). Below this is a table of treatment sessions with columns: TIME, HP, MODE, FLUENCE, RATE, SPOT, SHOT, LESION, and FB. The table contains 9 rows of data. At the bottom, there are two large buttons: '3 BACK' and '4 TREATMENT'.

TIME	HP	MODE	FLUENCE	RATE	SPOT	SHOT	LESION	FB
07.23.18 12:05	Zoom	532	50.0	10	10	10000	Freckle	☹️
05.20.18 14:32	VMLA	1064	40.0	8	8	10000	Tanning	☹️
02.28.18 10:24	Zoom	1064	35.0	6	6	5000	Tattoo	☹️
07.23.18 12:05	Colli-	1064	50.0	8	8	8000	Letigo	😊
05.20.18 14:32	Zoom	532	40.0	10	10	10000	PIH	😊
02.28.18 10:24	VMLA	1064	35.0	7	7	10000	Freckle	😊
07.23.18 12:05	Zoom	1064	50.0	6	6	10000	Tanning	😊
05.20.18 14:32	Colli-	1064	40.0	6	6	5000	Tattoo	☹️

No.	Name	Function
1	<b>Feed back</b>	FEEDBACK SURVEY screen pops up
2		Skip patient information and move to TREATMENT screen
3	<b>BACK</b>	Returns to the previous page.
4	<b>TREATMENT</b>	Move to TREATMENT screen

**\* FEEDBACK SURVEY**

- Rate the patient's satisfaction level by selecting one of the five icons.



## \* ZOOM H/P – 1064 Mode selection screen

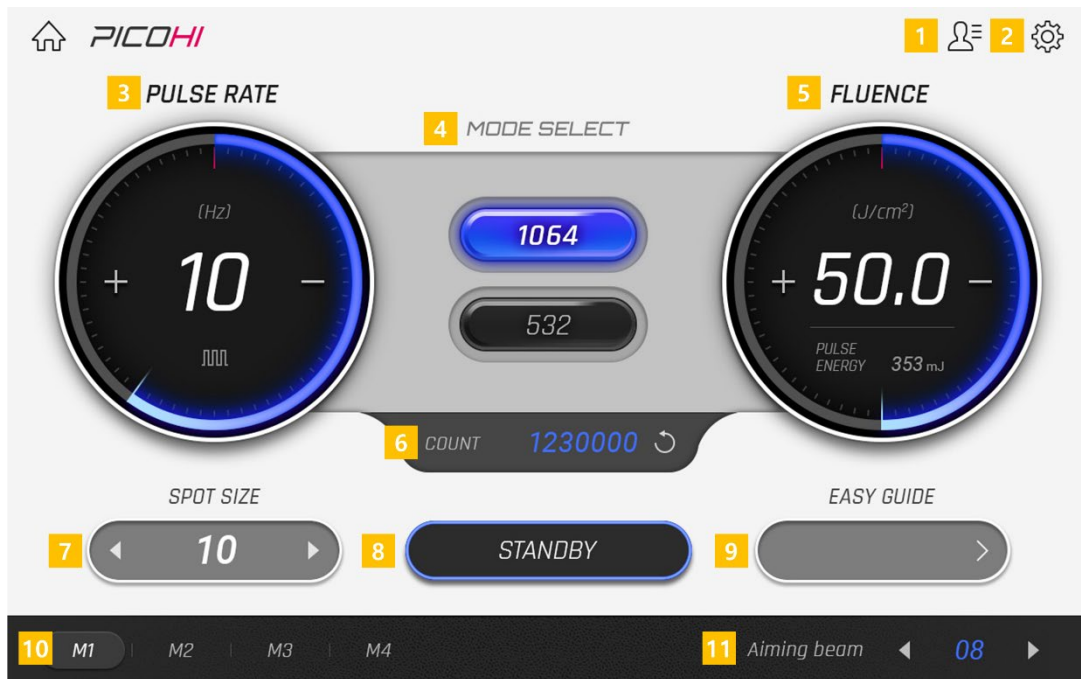

No.	Name	Function
1	<b>Patient Information</b>	Displays the patient's information selection screen.
2	<b>Settings</b>	Configure sound volume and other custom settings.
3	<b>PULSE RATE</b>	Use the "+" and "-" buttons to adjust the pulse rate.
4	<b>MODE SELECT</b>	Use the "1064" and "532" buttons to select a mode.
5	<b>FLUENCE</b>	Use the "+" and "-" buttons to adjust the value of fluence (J/ cm²). (The limit of the FLUENCE setting value is displayed in red scale)
6	<b>COUNT</b>	View or reset the Shot count.
7	<b>SPOT SIZE</b>	Shows the handpiece spot size. Laser irradiation does not work if the displayed spot size does not match the actual handpiece spot size.
8	<b>STAND BY / READY</b>	When you are ready to give treatment, press the STAND-BY button. The button switches to the READY button and you can step on the foot switch to start energy irradiation.
9	<b>EASY GUIDE</b>	Provides a treatment guide screen for laser using 1064 nm Wavelength.
10	<b>Save button</b>	Save settings changed by the operator between M1 and M4.
11	<b>Aiming Beam</b>	Adjust the aiming beam brightness from 0 to 10.

## \* ZOOM H/P – 532 Mode selection screen

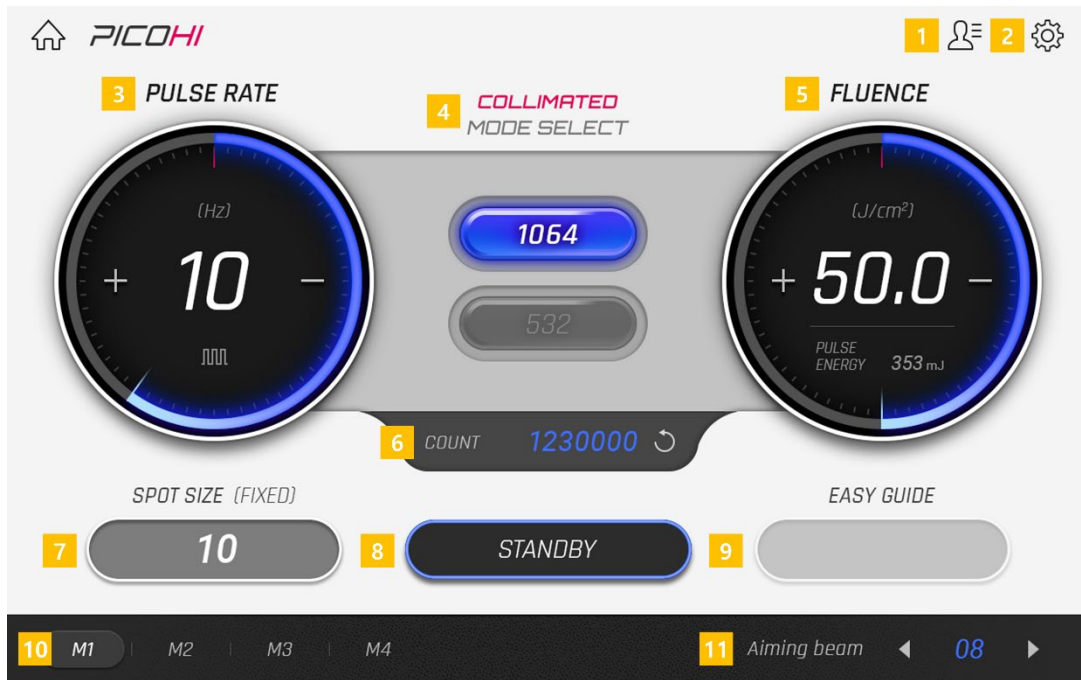

No.	Name	Function
1	<b>PATIENT INFORMATION</b>	Displays the patient's information selection screen.
2	<b>SETTINGS</b>	Configure sound volume and other custom settings.
3	<b>PULSE RATE</b>	Use the "+" and "-" buttons to adjust the pulse rate.
4	<b>MODE SELECT</b>	Use the "1064" and "532" buttons to select a mode.
5	<b>FLUENCE</b>	Use the "+" and "-" buttons to adjust the value of fluence (J/ cm <sup>2</sup> ). (The limit of the FLUENCE setting value is displayed in red scale)
6	<b>COUNT</b>	View or reset the Shot count.
7	<b>SPOT SIZE</b>	Shows the handpiece spot size. Laser irradiation does not work if the displayed spot size does not match the actual handpiece spot size.
8	<b>STAND BY / READY</b>	When you are ready to give treatment, press the STAND-BY button. The button switches to the READY button and you can step on the foot switch to start energy irradiation.
9	<b>EASY GUIDE</b>	Provides a treatment guide screen for laser using 532 nm Wavelength.
10	<b>SAVE BUTTON</b>	Save settings changed by the operator between M1 and M4. (Settings can be saved by pressing and holding the button for 3 seconds.)
11	<b>AIMING BEAM</b>	Adjust the aiming beam brightness from 0 to 10

\* **COLLIMATED H/P screen**

No.	Name	Function
1	<b>PATIENT INFORMATION</b>	Displays the patient's information selection screen.
2	<b>SETTINGS</b>	Configure sound volume and other custom settings.
3	<b>PULSE RATE</b>	Use the "+" and "-" buttons to adjust the pulse rate.
4	<b>MODE SELECT</b>	Displays the settings screen for the connected COLLIMATED handpiece.
5	<b>FLUENCE</b>	Use the "+" and "-" buttons to adjust the value of fluence (J/cm²). (The limit of the FLUENCE setting value is displayed in red scale)
6	<b>COUNT</b>	View or reset the Shot count.
7	<b>SPOT SIZE(FIXED)</b>	Shows the 1064 COLLIMATED mode handpiece spot size. The handpiece spot size is fixed and cannot be changed.
8	<b>STAND BY / READY</b>	When you are ready to give treatment, press the STAND-BY button. The button switches to the READY button and you can step on the foot switch to start energy irradiation.
9	<b>EASY GUIDE</b>	Provides a treatment guide screen for laser using 1064 nm wavelength.
10	<b>SAVE BUTTON</b>	Save settings changed by the operator between M1 and M4. (Settings can be saved by pressing and holding the button for 3 seconds.)
11	<b>AIMING BEAM</b>	Adjust the aiming beam brightness from 0 to 10.

## \* VMLA H/P – 1064 Mode selection screen

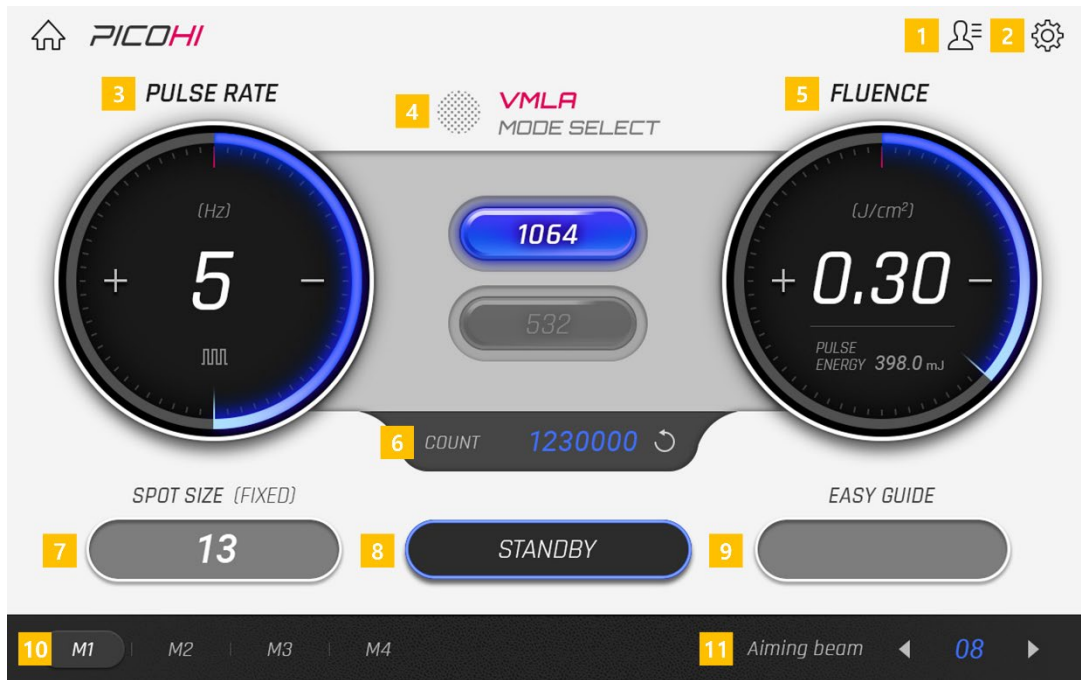

No.	Name	Function
1	<b>PATIENT INFORMATION</b>	Displays the patient's information selection screen.
2	<b>SETTINGS</b>	Configure sound volume and other custom settings.
3	<b>PULSE RATE</b>	Use the "+" and "-" buttons to adjust the pulse rate.
4	<b>MODE SELECT</b>	Displays the settings screen for the connected VMLA handpiece.
5	<b>FLUENCE</b>	Use the "+" and "-" buttons to adjust the value of fluence (J/ cm²). (The limit of the FLUENCE setting value is displayed in red scale)
6	<b>COUNT</b>	View or reset the Shot count.
7	<b>SPOT SIZE(FIXED)</b>	Shows the 1064 VMLA mode handpiece spot size. The handpiece spot size is fixed and cannot be changed.
8	<b>STAND BY / READY</b>	When you are ready to give treatment, press the STAND-BY button. The button switches to the READY button and you can step on the foot switch to start energy irradiation.
9	<b>EASY GUIDE</b>	Provides a treatment guide screen for laser using 1064 nm wavelength.
10	<b>SAVE BUTTON</b>	Save settings changed by the operator between M1 and M4. (Settings can be saved by pressing and holding the button for 3 seconds.)
11	<b>AIMING BEAM</b>	Adjust the aiming beam brightness from 0 to 10.

## \* VMLA H/P – 532 Mode selection screen

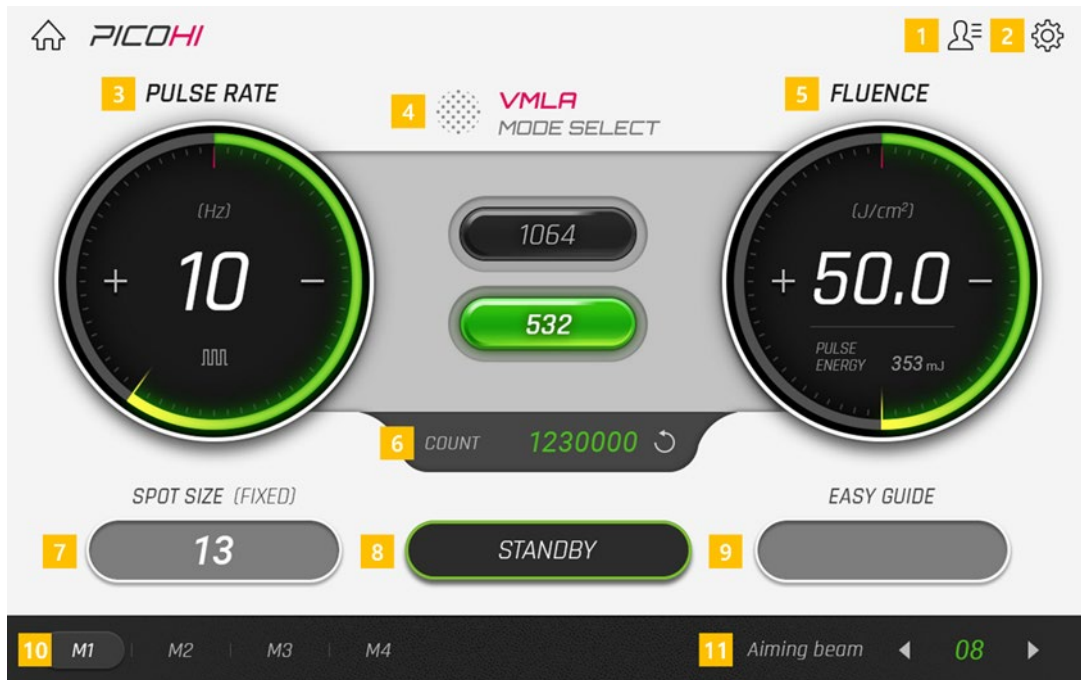

No.	Name	Function
1	<b>PATIENT INFORMATION</b>	Displays the patient's information selection screen.
2	<b>SETTINGS</b>	Configure sound volume and other custom settings.
3	<b>PULSE RATE</b>	Use the "+" and "-" buttons to adjust the pulse rate.
4	<b>MODE SELECT</b>	Displays the settings screen for the connected VMLA handpiece.
5	<b>FLUENCE</b>	Use the "+" and "-" buttons to adjust the value of fluence (J/cm <sup>2</sup> ). (The limit of the FLUENCE setting value is displayed in red scale)
6	<b>COUNT</b>	View or reset the Shot count.
7	<b>SPOT SIZE(FIXED)</b>	Shows the 532 VMLA mode handpiece spot size. The handpiece spot size is fixed and cannot be changed.
8	<b>STAND BY / READY</b>	When you are ready to give treatment, press the STAND-BY button. The button switches to the READY button and you can step on the foot switch to start energy irradiation.
9	<b>EASY GUIDE</b>	Displays a treatment guide screen for laser using 532 nm wavelength.
10	<b>SAVE BUTTON</b>	Save settings changed by the operator between M1 and M4. (Settings can be saved by pressing and holding the button for 3 seconds.)
11	<b>AIMING BEAM</b>	Adjust the aiming beam brightness from 0 to 10.

## \* ZMLA H/P – 1064 Mode selection screen

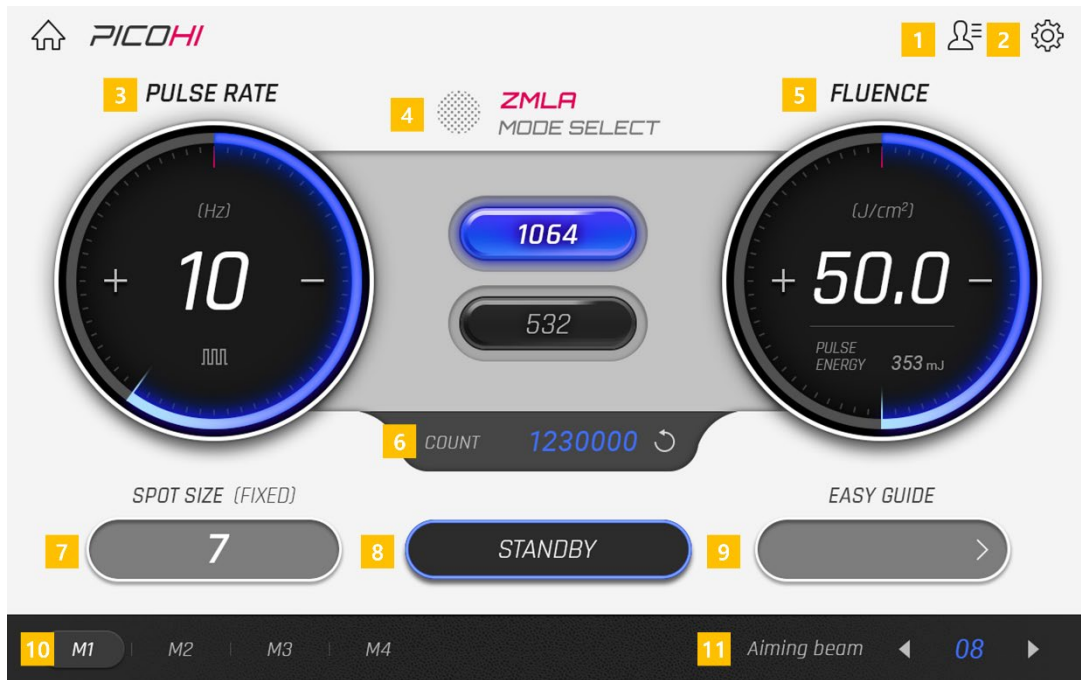

No.	Name	Function
1	<b>PATIENT INFORMATION</b>	Displays the patient's information selection screen.
2	<b>SETTINGS</b>	Configure sound volume and other custom settings.
3	<b>PULSE RATE</b>	Use the "+" and "-" buttons to adjust the pulse rate.
4	<b>MODE SELECT</b>	Displays the settings screen for the connected ZMLA handpiece.
5	<b>FLUENCE</b>	Use the "+" and "-" buttons to adjust the value of fluence (J/cm <sup>2</sup> ). (The limit of the FLUENCE setting value is displayed in red scale)
6	<b>COUNT</b>	View or reset the Shot count.
7	<b>SPOT SIZE</b>	H/P SPOT SIZE can be adjusted.
8	<b>STAND BY / READY</b>	When you are ready to give treatment, press the STAND-BY button. The button switches to the READY button and you can step on the foot switch to start energy irradiation.
9	<b>EASY GUIDE</b>	Displays a treatment guide screen for laser using 1064 nm wavelength.
10	<b>SAVE BUTTON</b>	Save settings changed by the operator between M1 and M4. (Settings can be saved by pressing and holding the button for 3 seconds.)
11	<b>AIMING BEAM</b>	Adjust the aiming beam brightness from 0 to 10.

## \* ZMLA H/P – 532 Mods selection screen

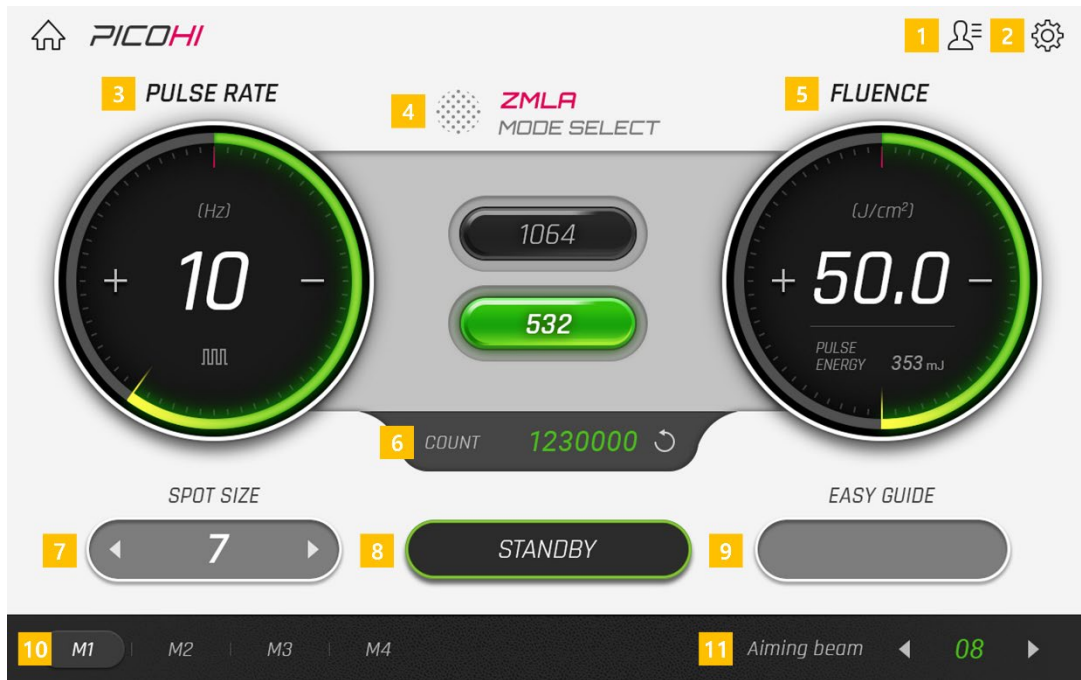

No.	Name	Function
1	<b>PATIENT INFORMATION</b>	Displays the patient's information selection screen.
2	<b>SETTINGS</b>	Configure sound volume and other custom settings.
3	<b>PULSE RATE</b>	Use the "+" and "-" buttons to adjust the pulse rate.
4	<b>MODE SELECT</b>	Displays the settings screen for the connected ZMLA handpiece.
5	<b>FLUENCE</b>	Use the "+" and "-" buttons to adjust the value of fluence (J/cm²). (The limit of the FLUENCE setting value is displayed in red scale)
6	<b>COUNT</b>	View or reset the Shot count.
7	<b>SPOT SIZE</b>	H/P SPOT SIZE can be adjusted.
8	<b>STAND BY / READY</b>	When you are ready to give treatment, press the STAND-BY button. The button switches to the READY button and you can step on the foot switch to start energy irradiation.
9	<b>EASY GUIDE</b>	Displays a treatment guide screen for laser using 532 nm wavelength.
10	<b>SAVE BUTTON</b>	Save settings changed by the operator between M1 and M4. (Settings can be saved by pressing and holding the button for 3 seconds.)
11	<b>AIMING BEAM</b>	Adjust the aiming beam brightness from 0 to 10.

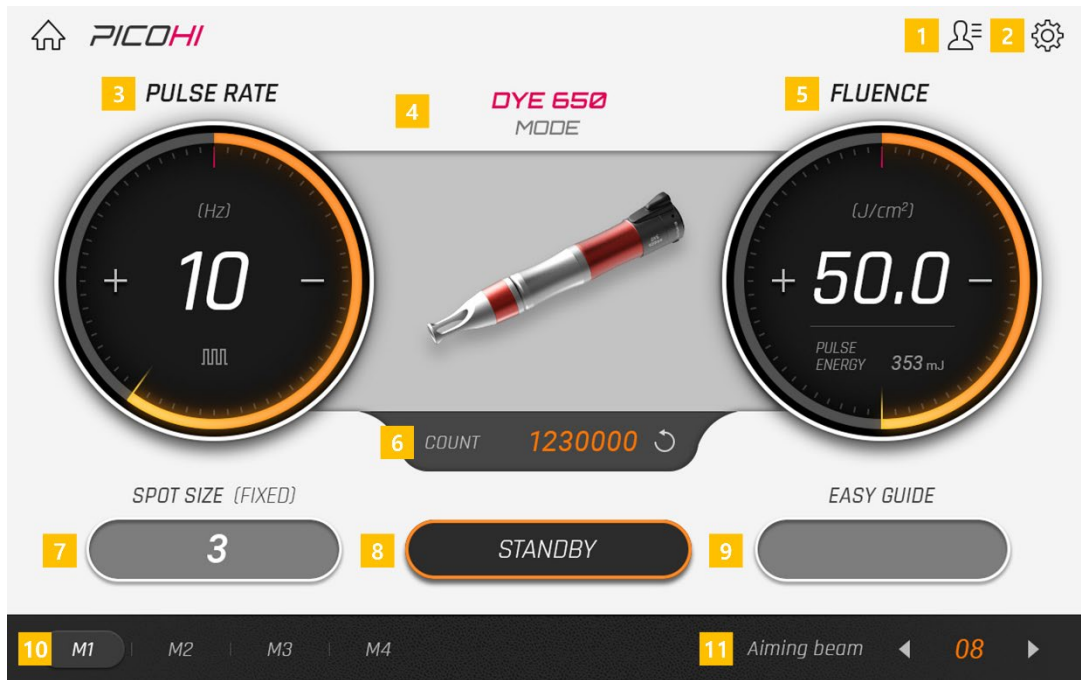
\* **DYM 650 H/P screen**

No.	Name	Function
1	<b>PATIENT INFORMATION</b>	Displays the patient's information selection screen.
2	<b>SETTINGS</b>	Configure sound volume and other custom settings.
3	<b>PULSE RATE</b>	Use the "+" and "-" buttons to adjust the pulse rate.
4	<b>DYE 650 MODE</b>	Displays the DYE 650 screen.
5	<b>FLUENCE</b>	Use the "+" and "-" buttons to adjust the value of fluence (J/cm <sup>2</sup> ). (The limit of the FLUENCE setting value is displayed in red scale)
6	<b>COUNT</b>	View or reset the Shot count.
7	<b>SPOT SIZE (FIXED)</b>	Shows the DYE 650 handpiece spot size. The handpiece spot size is fixed and cannot be changed.
8	<b>STAND BY / READY</b>	When you are ready to give treatment, press the STAND-BY button. The button switches to the READY button and you can step on the foot switch to start energy irradiation.
9	<b>EASY GUIDE</b>	Displays a treatment guide screen for laser using 650 nm wavelength.
10	<b>SAVE BUTTON</b>	Save settings changed by the operator between M1 and M4. (Settings can be saved by pressing and holding the button for 3 seconds.)
11	<b>AIMING BEAM</b>	Adjust the aiming beam brightness from 0 to 10.

## \* DOE H/P – 532 Mode selection screen

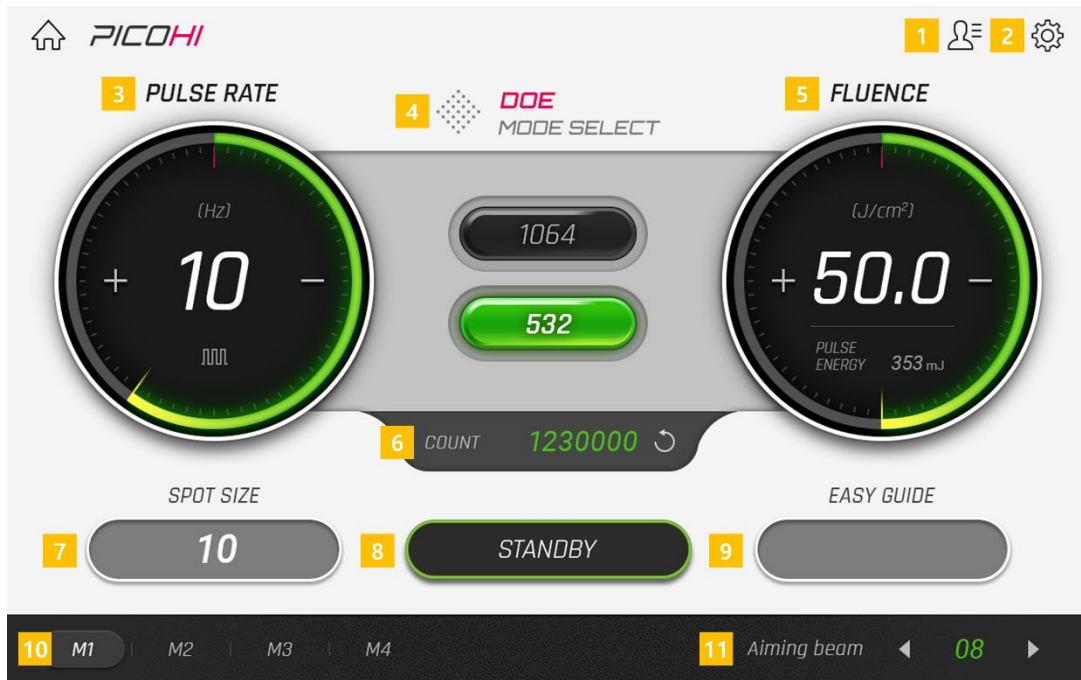

No.	Name	Function
1	<b>PATIENT INFORMATION</b>	Displays the patient's information selection screen.
2	<b>SETTINGS</b>	Configure sound volume and other custom settings.
3	<b>PULSE RATE</b>	Use the "+" and "-" buttons to adjust the pulse rate.
4	<b>MODE SELECT</b>	Displays the DOE 532 screen.
5	<b>FLUENCE</b>	Use the "+" and "-" buttons to adjust the value of fluence (J/cm <sup>2</sup> ). (The limit of the FLUENCE setting value is displayed in red scale)
6	<b>COUNT</b>	View or reset the Shot count.
7	<b>SPOT SIZE (FIXED)</b>	Shows the DOE 532 handpiece spot size. The handpiece spot size is fixed and cannot be changed.
8	<b>STAND BY / READY</b>	When you are ready to give treatment, press the STAND-BY button. The button switches to the READY button and you can step on the foot switch to start energy irradiation.
9	<b>EASY GUIDE</b>	Displays a treatment guide screen for laser using 532 nm wavelength.
10	<b>SAVE BUTTON</b>	Save settings changed by the operator between M1 and M4. (Settings can be saved by pressing and holding the button for 3 seconds.)
11	<b>AIMING BEAM</b>	Adjust the aiming beam brightness from 0 to 10.

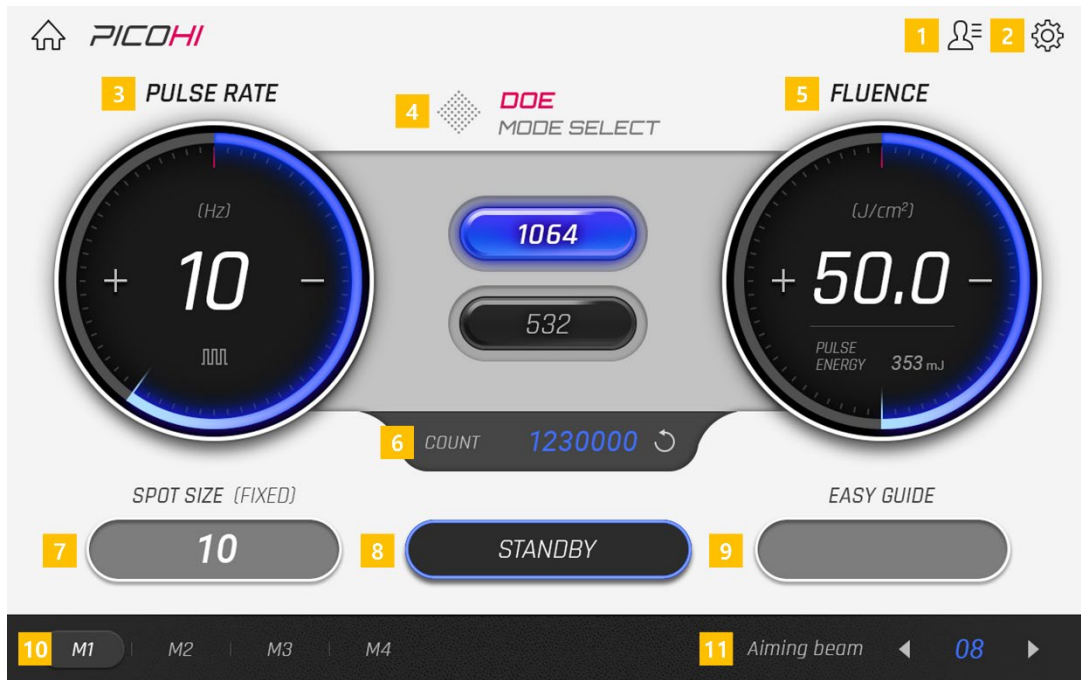

## \* DOE H/P – 1064 Mode selection screen

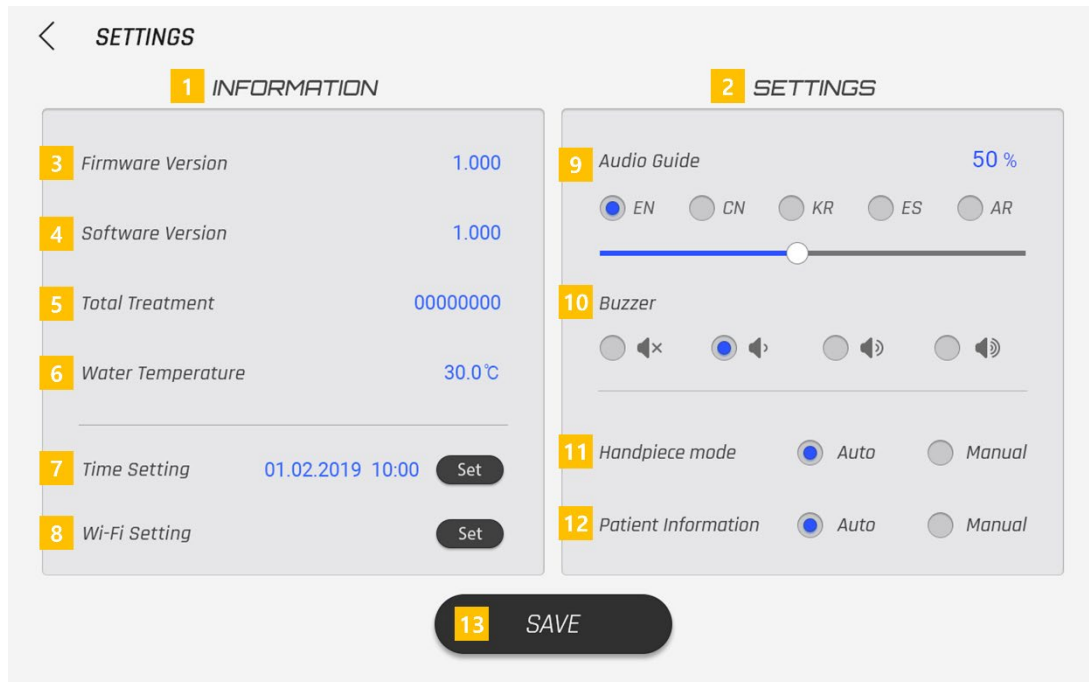

No.	Name	Function
1	<b>PATIENT INFORMATION</b>	Displays the patient's information selection screen.
2	<b>SETTINGS</b>	Configure sound volume and other custom settings.
3	<b>PULSE RATE</b>	Use the "+" and "-" buttons to adjust the pulse rate.
4	<b>MODE SELECT</b>	Displays the DOE 1064 screen.
5	<b>FLUENCE</b>	Use the "+" and "-" buttons to adjust the value of fluence (J/ cm²). (The limit of the FLUENCE setting value is displayed in red scale)
6	<b>COUNT</b>	View or reset the Shot count.
7	<b>SPOT SIZE</b>	Shows the DOE 1064 handpiece spot size. The handpiece spot size is fixed and cannot be changed.
8	<b>STAND BY / READY</b>	When you are ready to give treatment, press the STAND-BY button. The button switches to the READY button and you can step on the foot switch to start energy irradiation.
9	<b>EASY GUIDE</b>	Displays a treatment guide screen for laser using 1064 nm wavelength.
10	<b>SAVE BUTTON</b>	Save settings changed by the operator between M1 and M4. (Settings can be saved by pressing and holding the button for 3 seconds.)
11	<b>AIMING BEAM</b>	Adjust the aiming beam brightness from 0 to 10.

## \* Information provided on the SETTINGS screen



No.	Name	Function
1	<b>INFORMATION</b>	Shows information on the system status.
2	<b>SETTINGS</b>	Shows settings that can be configured.
3	<b>FIRMWARE VERSION</b>	Shows the firmware version.
4	<b>SOFTWARE VERSION</b>	Shows the software version.
5	<b>TOTAL TREATMENT</b>	Shows the total shot count.
6	<b>WATER TEMPERATURE</b>	Shows the water temperature.
7	<b>TIME SETTING</b>	 Set the time.
8	<b>WI-FI SETTING</b>	 Configure WI-FI settings.
9	<b>AUDIO GUIDE</b>	Select a voice menu language to use with the system.
10	<b>BUZZER</b>	Set the SOUND volume.
11	<b>HANDPIECE MODE</b>	Selection of AUTO or MANUAL mode AUTO: The screen automatically updates the spot size each time the handpiece spot size is adjusted. MANUAL: The spot size displayed on the screen should manually be changed when the handpiece spot size is adjusted. Laser irradiation does not work if the displayed spot size does not match the actual handpiece spot size.
12	<b>PATIENT INFORMATION</b>	Selection of AUTO or MANUAL mode AUTO: When TREATMENT is selected on the INTRO screen, the TREATMENT INFORMATION screen is displayed. MANUAL: When TREATMENT is selected on the INTRO screen, the PATIENT INFORMATION screen does not appear.
13	<b>SAVE</b>	Save current settings.

\* **TIME SETTING**

< 1 **SETTINGS**

Time Settings

2

Month Day Year

00 00 0000

Hour (24) Minute

00 : 00

3 **SAVE**

No.	Name	Function
1	<b>SETTINGS</b>	Displays the previous screen.
2	<b>TIME SETTINGS</b>	Configure specific time settings: Month, Day, Year, Hour (24), Minute.
3	<b>SAVE</b>	Save current settings.

\* Information provided on the SETTINGS screen

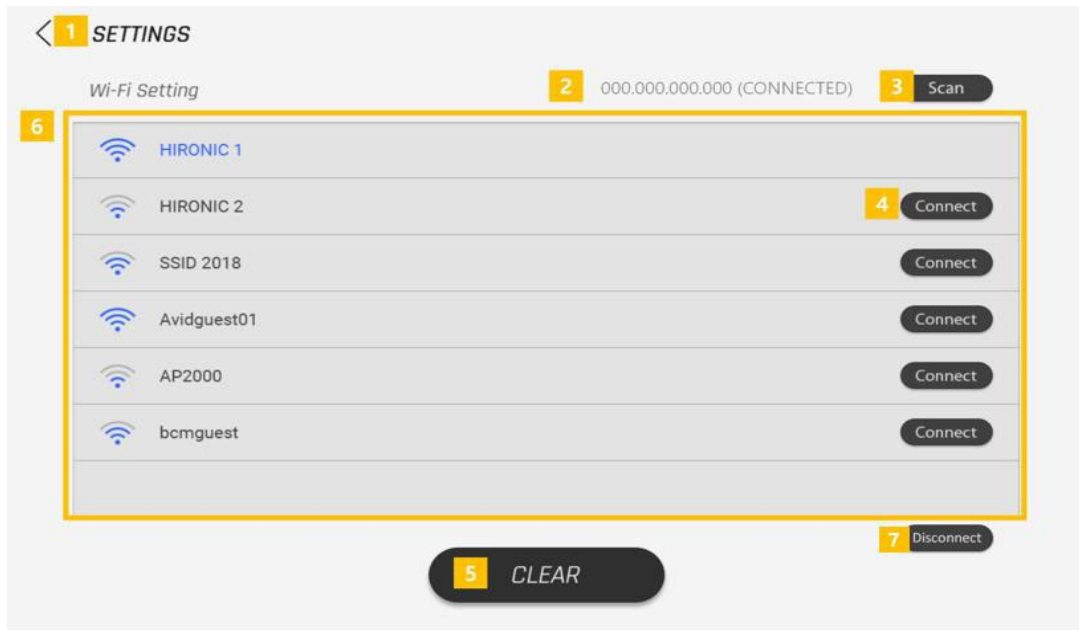

No.	Name	Function
1	SETTINGS	Displays the SETTINGS screen.
2	CONNECTED	Displays connected WI-FI IP address
3	SCAN	Scans the Wi-Fi.
4	CONNECT	Connects to the selected Wi-Fi.
5	CLEAR	Resets a scanned Wi-Fi.
6	CONNECT OBJECT	List of connectable WI-FI.
7	DISCONNECT	Disconnects the connected WI-FI.

## 4. Maintenance and Storage

### 4.1 Storage and Maintenance after Use

- \* The system and components should be inspected on a regular basis.
- \* If excessive force is applied to the handpiece or the handpiece holder on the main unit, the handpiece holder may become damaged.
- \* Cover the laser output port with the protective cap to prevent the port from exposure to the air.
- \* Clean the handpiece lens with an appropriate cleaning tool, e.g. lens cleaning tissue paper or dedicated laser lens cleaning tool, and dry the lens thoroughly before storage.
- \* Handling of the key switch should be performed by the system manager and user (with a legal license). After treatment is finished, make sure the key switch is stored in the storage box to prevent the key switch from being accessed by unauthorized persons.
- \* If it is deemed that the system does not operate properly or has broken down, please contact the manufacturer for assistance. Do not arbitrarily disassemble the system.
- \* To use the system after it has been unused for an extended period of time, first check that the system is clean, safe and working properly.

### 4.2 Precautions for Storage

- \* Make sure the key switch is only handled by the authorized person in charge.
- \* Store the system in a place that is not affected by direct sunlight, moisture, atmospheric pressure, temperature, humidity, ventilation, sun rays, dust, or air containing salt.
- \* Do not store the system in a bathroom or other places that are highly humid.
- \* If it is deemed that the system does not operate properly or has broken down, please contact the manufacturer for assistance. Do not arbitrarily disassemble the system.
- \* Ensure that the system is maintained in a safe state under any conditions, including when the system is transported, to ensure protection against slopes, vibration or excessive force.
- \* Storing the equipment for a long time without using the equipment, check the amount of distilled water. If it is insufficient, replenish distilled water before using.
- \* Reusing after long-term storage at a temperature of 3°C or lower, use it after checking with our customer support team and agency(overseas).
- \* In case of leakage distilled water of the equipment or cartridge, stop using it and check it at our customer support team and agency (overseas) before using.



#### NOTE

	Operating conditions	Transport and storage conditions
<b>Temperature</b>	10°C ~ 30°C	10°C ~ 40°C
<b>Relative humidity</b>	30% ~ 70%	30% ~ 70%
<b>Atmospheric pressure</b>	80 ~ 106 kPa	80 ~ 106 kPa

### 4.3 Preparations for Transportation

- \* To transport the product to another location, follow the steps below.
- \* Separate all components, including the Articulated arm, handpiece and foot switch, from the system.
- \* Put the Articulated arm in the dedicated storage case to prevent damage to the unit.
- \* Put the system in a dedicated transport box. Exercise caution to ensure that the system does not collide with other objects during transportation.
- \* If a dedicated storage box is not available, pack the system with other material that can prevent excessive force or scratches.

### 4.4 Cleaning the Product

- \* Use a soft brush to remove dust and other foreign materials off the electrical outlet.
- \* Always check that there is no foreign material found in or on the electrical outlet before connecting the power cable.
- \* Use a soft cloth to wipe the main unit.
- \* Do not use water or oils, e.g. benzene or thinner, to clean the system.
- \* Use exclusive cleaning tools (e.g. pure acetone, lens cleaning tissue paper) to clean the handpiece lens and dry it thoroughly before storage.
- \* Make sure you clean the handpiece lens after treatment so as to prevent skin infections.
- \* After using the system, make sure you turn it off and use a dry cloth or soft brush to wipe the system.
- \* Do not touch the front of the system with wet hands.



#### Caution

**Ensure that the system is inspected regularly on an annual basis.**



#### Caution

**When transporting the system, exercise caution to ensure that the Articulated arm is not damaged.  
If the Articulated arm or handpiece lens is damaged, laser radiation may malfunction.  
This may cause severe problems on the skin of patients.**



#### NOTE

**If it is deemed that the system does not operate properly or has broken down, please contact the manufacturer for assistance. Do not arbitrarily disassemble the system. If the product has been disassembled arbitrarily and the product malfunctions, the issue will not be covered by our paid or free-of-charge repair service. We hereby notify that we will not and shall not be held accountable for any and all legal problems caused by disassembly at your discretion.**

## Cleaning the handpiece

1. Separate the handpiece.



Handpiece tip



Handpiece body

2. Use a cotton swab to wipe the inner part of the handpiece tip carefully.  
Use a cotton swab to wipe the lens in the inner part of the handpiece tip carefully.

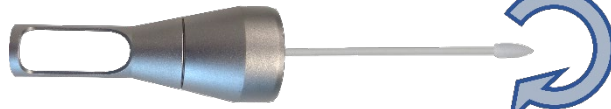

Cleaning of handpiece tip and lens

3. Use a cotton swab to wipe the separated handpiece body.  
Use a cotton swab to wipe the lens on the handpiece body carefully.

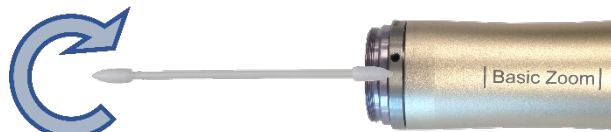

Cleaning of handpiece body and lens

**Caution**

Use a cotton swab, wet with ethanol, to remove foreign material on the surface of the separated handpiece body and the handpiece tip. Use caution to ensure that the surface coating is not damaged.

## Replenishing distilled water

If the distilled water lever is low, follow the steps below.

1. Prepare Water injection hose and hose cables for water injection.



Hose Cable



Water injection hose

2. Cut off power to the system.
3. Open the front door of PICOHI™ 300.

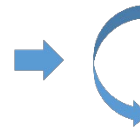

4. Open the distilled water cover on the front door that has been opened.



5. Plug the Water injection hose and hose cable into the marked distillation hole and add distilled water.

※ If distilled water is injected without the hose cable, distilled water will not be injected.

- ① Distilled water inlet port
- ② Air port



6. Replenish distilled water until the MAX level is reached.
7. After replenishing of distilled water is finished, attach the distilled water cover back to the front door.

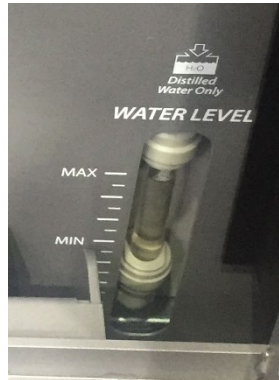

8. To discharge distilled water, insert a hose into the distilled water outlet port on the bottom of the main unit and discharge distilled water.

※ When discharging distilled water by connecting to the bottom hole of the main body, connect the hose cable to the distillation hole on the front to drain the distilled water.



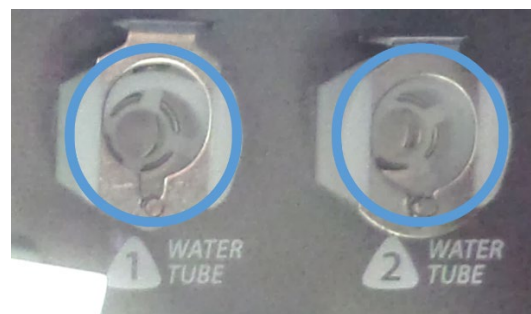

Bottom hole



Distillation hole

## 5. Troubleshooting

### 5.1 Steps to Take in Emergency Situations

Symptom	Steps to take
<p><b>Burning smell is coming from the product</b></p> <p><b>Abnormal noise is coming from the product</b></p>	<ul style="list-style-type: none"> <li>* Press the power button on the rear of the system to turn it off.</li> <li>* Disconnect the power cable from the electrical outlet.</li> <li>* Contact the original distributor or our after-sales service center.</li> </ul> <div style="border: 1px solid black; padding: 5px; margin-top: 10px;"> <p> <b>Caution</b></p> <p><b>If the product is used continuously, internal modules may become damaged one after another and fire or safety accidents may occur.</b></p> </div>
<p><b>The display screen is broken or damaged</b></p>	<ul style="list-style-type: none"> <li>* Immediately stop the treatment and use of the product.</li> <li>* Turn off the system and remove the power cable from the electrical outlet.</li> <li>* Contact the original distributor or our after-sales service center.</li> </ul> <div style="border: 1px solid black; padding: 5px; margin-top: 10px;"> <p> <b>Caution</b></p> <p><b>If the touch screen is broken and the system is used continuously, energy will not be irradiated uniformly and the patient's skin may become damaged.</b></p> </div>
<p><b>Blisters or burns are present in the treated area</b></p>	<ul style="list-style-type: none"> <li>• Immediately cool the affected area. Apply burn ointment to the area to hasten skin regeneration, if necessary.</li> </ul>

## 5.2 Steps to Take by Symptom

Symptom	Steps to take
<b>The system cannot be turned on</b>	<ul style="list-style-type: none"> <li>* Check that power is applied to the electrical outlet and the power cable is plugged properly.</li> <li>* Check that the power cable is firmly connected to the system.</li> <li>* Check that the power switch (circuit breaker) on the rear of the system works properly. (If over current enters the system, the circuit breaker may not work properly.)</li> <li>* If the main unit still does not operate after checking the above, contact the original distributor or our after-sales service center.</li> </ul>
<b>The main power switch (circuit breaker) on the rear of the system does not work properly</b>	<ul style="list-style-type: none"> <li>* Turn off the power switch (circuit breaker) on the rear of the main unit.</li> <li>* Check the power cable connection and check if the system can be turned on/ off.</li> <li>* Repeatedly turn on and off the key switch on the front of the system 2 to 3 times. If the main unit does not respond, contact the original distributor or our after-sales service center.</li> </ul>
<b>Loud noise is audible</b>	<ul style="list-style-type: none"> <li>* Check that the product is located on a flat, stable surface.</li> <li>* Check that the product is at least 30 cm away from the wall.</li> <li>* Contact our service center if the noise is irregular or too loud.</li> </ul>
<b>Laser irradiation does not work</b>	<ul style="list-style-type: none"> <li>* If laser irradiation does not work, there may be a problem with the Articulated arm. Check for damage in the Articulated arm or the handpiece lens.</li> <li>* If the problem persists, contact the original distributor or our after-sales service center.</li> </ul>
<b>The Emergency Stop button does not work</b>	<ul style="list-style-type: none"> <li>* Turn the button left and right to return it to the original position.</li> <li>* Turn the key switch left and right and turn on/off the system to see if it works properly.</li> <li>* Check that there is no problem with the power switch or power cable.</li> <li>* If the button still does not work after checking the above, contact the original distributor or our after-sales service center.</li> </ul>

### 5.3 Error Message

Name	Function
<p><b>Spot Size Changed</b></p>	<p><b>Spot Size Changed</b></p> <p>※ This message appears when the handpiece spot size has been changed.</p>
<p><b>532nm ZOOM Handpiece connected</b></p>	<p><b>532 nm ZOOM Handpiece connected</b></p> <p>※ This message appears when the 532 nm Zoom handpiece has been connected.</p>
<p><b>1064nm ZOOM Handpiece connected</b></p>	<p><b>1064 nm ZOOM Handpiece connected</b></p> <p>※ This message appears when the 1064 nm Zoom handpiece has been connected.</p>
<p><b>1064nm Collimated Handpiece connected</b></p>	<p><b>1064 nm Collimated Handpiece connected</b></p> <p>※ This message appears when the 1064 nm Collimated handpiece has been connected.</p>
<p><b>VMLA Handpiece connected</b></p>	<p><b>VMLA Handpiece connected</b></p> <p>※ This message appears when the VMLA handpiece has been connected.</p>
<p><b>ZMLA Handpiece connected</b></p>	<p><b>ZMLA Handpiece connected</b></p> <p>※ This message appears when the ZMLA handpiece has been connected.</p>
<p><b>DOE 532 Handpiece connected</b></p>	<p><b>DOE 532 Handpiece connected</b></p> <p>※ This message appears when the DOE 532 handpiece has been connected.</p>
<p><b>DOE 1064 Handpiece connected</b></p>	<p><b>DOE 1064 Handpiece connected</b></p> <p>※ This message appears when the DOE 1064 handpiece has been connected.</p>
<p><b>DYE 650 Handpiece connected</b></p>	<p><b>DYE 650 Handpiece connected</b></p> <p>※ This message appears when the DYE 650 handpiece has been connected.</p>

## 6. Warranty

---

### 6.1 Overview

This section describes the warranty coverage for normal use of the product and exceptions to the warranty.

.

### 6.2 Warranty Coverage

- \* If the product has been used for intended purposes, Hironic Co., Ltd. provides a warranty for one year after the Delivery.
- \* Coverage of this warranty includes the main unit, Articulated arm, articulated arm handpiece, and foot switch. Consumable components are excluded from the coverage.
- \* If you request repairs that fall within the required conditions for the warranty coverage, repair or replacement will be performed at either the head office of Hironic Co., Ltd. or where the product is located, depending on the target component for repair and the period of time required for the repair.
- \* If the product needs to be returned to Hironic Co., Ltd. for repair or adjustment, a temporary repair or replacement will be offered upon request by the customer.
- \* When making a warranty claim, the user should provide Hironic Co., Ltd. with materials, video or photos that show details of the problem.



#### NOTE

- \* **To maintain free-of-charge warranty, repair or modification shall be performed by service personnel officially appointed by Hironic Co., Ltd. If the product was not used for the intended purpose or the instructions herein were not followed and the product malfunctions, the issue will not be covered by the warranty. Make sure you thoroughly read and understand the user manual.**
- \* **Hironic Co., Ltd. shall be responsible and entitled to make a decision regarding details and the cause of a damage in the product; the decision is final and subject to no change.**



#### NOTE

**If the system has been disassembled or modified arbitrarily and the system malfunctions, the issue will not be covered by the warranty.**

### 6.3 Exceptions to the Warranty

Problems caused by failure to follow the instructions and safety precautions suggested in this manual will not be covered by the warranty. The following instructions need to be followed with extra caution when using the product.

- \* Damage to the Articulated arm or handpiece, caused due to the user's negligence when using or moving the product, is not covered by warranty.
- \* The warranty is void if the product has been used for unintended purposes or it has been altered or disassembled.
- \* Consumables are not covered by the warranty.
- \* Damage or loss due to the user's carelessness is not covered by the warranty.
- \* The warranty is void if a damage has occurred due to disassembly of or shock to the system or Articulated arm, the Articulated arm or handpiece has been damaged or removed from the main unit due to excessive force applied to them, or the system has been disassembled or repaired by someone that is not a service technician authorized by Hironic Co., Ltd.
- \* The warranty is void if a seal on the product has been damaged without permission by Hironic Co., Ltd.



#### NOTE

**Use only genuine components and consumables supplied by the manufacturer. If the product has been altered or modified arbitrarily and the product malfunctions, the issue will not be covered by our paid or free-of-charge repair service. Hironic Co., Ltd. is not responsible for any legal issues resulted from unauthorized tampering.**

# Warranty Certificate

This warranty certificate supersedes any explicit or implied warranties. The seller cannot guarantee the warranty or the conditions of the product.

<b>Hospital name</b>	
<b>Name</b>	
<b>Address</b>	
<b>Contact info.</b>	
<b>Mobile</b>	
<b>Email</b>	
<b>Product name</b>	<b>PICOHI™ 300</b>
<b>Serial NO.</b>	
<b>Delivery date</b>	
<b>Warranty expiration date</b>	
<b>Seller/Company</b>	
<b>Seller contact information</b>	
<b>Others</b>	

## Important!

To take full advantage of your warranty, please send the details above via email.

You can send the details via fax, but you will need to notify a contact person at Hironic Co., Ltd. in advance.



Hironic Co., Ltd.  
19F, U-TOWER, 767, Sinsu-ro, Suji-gu,  
Yongin-si,  
Gyeonggi-do, 16872, Republic of Korea  
Tel. +82-31-525-7000  
Fax. +82-31-525-7010  
www.hironic.com

### Customer Support Center

Tel. +82-31-525-7600  
E-mail: ocs@hironic.com



**PICOHI™ 300**

## User Manual

Hironic Co., Ltd.  
19F, U-TOWER, 767, Sinsu-ro, Suji-gu,  
Yongin-si, Gyeonggi-do, 16872,  
Republic of Korea  
Tel. +82-31-525-7000  
Fax. +82-31-525-7010  
[www.hironic.com](http://www.hironic.com)

## Customer Service Center

Tel. +82-31-525-7600  
E-Mail: [ocs@hironic.com](mailto:ocs@hironic.com)

 **HIRONIC**