

REVISIONS

REV	DESCRIPTION	DATE	BY



GUARINO & COX, LLC

19399 Helenbirg Rd. Suite 203
 Covington, La. 70433
 (985) 871-9997

THE USE OF THIS PLAN AND / OR DISCLOSURE OF ITS CONTENTS, IN ANY FASHION, IN
 WHOLE OR IN PART AND / OR ITS REPRODUCTION WITHOUT THE PREVIOUS WRITTEN
 PERMISSION OF "GUARINO & COX, LLC" IS STRICTLY PROHIBITED.

Conrad Industries, Inc

297'-6" x 54' x 12' INLAND TANK BARGE

VAPOR CONTROL SYSTEM CALCULATIONS

SCALE: NONE	DATE: 6/25/2009	DWG. NO. C-32
DRAWN BY: R. ALLUMS	CK'D BY: R. ALLUMS	
HULL NO. CONRAD C890 / ORANGE H407	JOB NO. 09-024	REV. 0

I. VAPOR CONTROL SYSTEM CALCULATIONS - SUMMARY**A. General Description of Vessel:**

Builder:	CONRAD INDUSTRIES, INC	
Builder's hull numbers:	Conrad C890 / Orange H407	
Year Built:	2009	
Official Numbers:	TBD	
Owner:	TBD	
Vessel Names:	TBD	
Vessel Dimensions:	297'-6" x 54'-0" x 12'-0"	
Service:	Inland Tank Barge (D/O) (Hull Type II, III)	
Classification:	None	
Max Design Working Pressure of Tanks:	3.00	(psig)
Max Cargo Loading Rate	5,500	(bbl/hr)
Maximum Discharge Rate	4,300	(bbl/hr)
VCS Cargoes:	See Table 1	
Maximum Vapor-Air Mixture Density:	0.35 (Pentane, all isomers)	(lbm/ft ³)
Maximum Vapor Growth Rate:	1.54 (Pentane, all isomers)	(lbm/ft ³)

B. General Description of Vapor Control System:

[Note: Also see Reference 6 for details of vapor control system.]

1. Pipe:

One (1) 8" diam longitudinal vapor header fitted with a 6" high-velocity PV Valve.
 One (1) 8" diam transverse vapor header with 8" shore connection valves.
 One (1) 8" diam branch line off longitudinal header to each cargo tank.
 (See Reference 6 for system layout)

2. High Velocity PV Valve:

Model:	ERL 6" SUPERAC PV-6	
Pressure Setting:	1.50	(psig)
Vacuum Setting:	0.5	(psig)
PV Valve Flow Capacity:	See Att. 1	(bbl/hr)

3. Spill Valve:

Model:	None installed
Pressure Setting:	N/A

4. Vapor Recovery Hose:

Diameter:	8" (assumed)
Length:	50' (assumed)

5. Cargo Tank P-V Valves:

	(One central P/V valve only, no individual tank P-V valves)	
Model:	See #2 above.	
Pressure Setting:	1.50	(psig)
Vacuum Setting:	0.5	(psig)

C. VCS Calculations:**1. Cargo Authority:**

The vapor collection system installed on this barge is designed for Grade A and lower petroleum products and chemicals. Typical cargoes to be carried by this barge are listed in Table 1. These cargoes are to be listed in the Cargo Authority Attachment (CAA) of the barge's Certificate of Inspection. Note that Table 1 is not intended to be an all-inclusive list and the CAA should therefore not be limited to these cargoes. Other cargoes with less restrictive or equal characteristics shall also be included on the CAA.

2. Determining Vapor-Air Mixture Density and Vapor Growth Rate:

Of the cargoes carried, Pentane has the highest vapor-air mixture density. Pentane also has the greatest vapor growth rate. (See Table 1)

3. The Maximum Liquid Transfer Rate as Imposed by the Capacity of the Cargo Tank Venting System: (Ref: 46 CFR 39.20-11)

Tanks #1 P/S are the farthest tanks from the High-Velocity P-V Valve in terms of total equivalent pipe length. Using factors from Reference 4 and 9, the total equivalent length of pipe is calculated for this path. This calculation is shown in Table 2.

Using Darcy's equation, and friction factors selected as appropriate for the pipe size, and the maximum liquid transfer rate, the pressure drop along the VCS piping from tank #1P to the P-V Valve is calculated using the total equivalent length of pipe from Table 2. The pressure drop calculations were done for the maximum loading rate (5,500 BBL/hr) for this barge. This maximum loading rate is based on loading one tank at a time. This calculation is shown in Table 3.

Conclusions:

Using a 5,500 bbl/hr maximum liquid transfer rate (for Pentane and lower cargos), the vapor-air mixture and air-equivalent volumetric flow rates for each cargo are shown in Table 3. The greatest pressure drop in the cargo tank venting system is 0.24 psig for Pentane cargo. At a pressure relief setting of 1.5 psig, the high-velocity P-V valve has an adequate flow capacity (see attachment 1). The greatest total back pressure imposed on the tanks by the cargo tank venting system (2.88 psig) does not exceed the design working pressure of the cargo tanks (3.00 psig). Also, the vacuum relieving capacity of the P-V Valve has been checked against the maximum discharge rate and has been found to have adequate vacuum relieving capacity (see Table 3).

4. The Maximum Liquid Transfer Rate as Imposed by the Relieving Capacity of the Cargo Tank Spill Valves:

No spill valves are installed on this barge.

5. The Maximum Liquid Transfer Rate as Imposed by the Set Point of the Overfill Alarm:

At the maximum cargo loading rate of 5,500 bbl/hr, required overfill alarm set points have been calculated such that the person in charge of the transfer operations has more than 60 seconds from the overfill alarm to stop the transfer operations before the tank overflows. (See attached overfill alarm set point calculation sheets.) The overfill alarms will need to be set at or below these calculated levels to ensure that the VCS complies with 46 CFR 39.20-9. In addition, the overfill alarms must also be set at or below a capacity of 98.5% to comply with 33CFR155.775.

6. The Maximum Liquid Transfer Rate as imposed by the pressure drop between the most remote tank and the facility vapor connection (Ref: 46 CFR 39.30-1(d)(3):

This requires the sum of the pressure drop along the longest path from the cargo tank to the vessel vapor connection and the back pressure at the facility vapor connection not to exceed 80 percent of the pressure setting of any pressure relief valve in the system. Tanks #1 P/S are the farthest from the facility vapor connection (in terms of total equivalent length of pipe). The total equivalent length from cargo tank #1P to the facility vapor connection is given in Table 4.

Using Darcy's equation, and friction factors selected as appropriate for the pipe size, and the maximum liquid transfer rate, the pressure drop along the VCS piping from tank #1P to the facility vapor connection is calculated using the total equivalent length of pipe from Table 4. These calculations are shown in Table 5.

Conclusions:

Pressure drop at the maximum liquid transfer rate of 5,500 bbl/hr (for Pentane and lower cargoes) along this path for each cargo is given in Table 5. The highest pressure drop (for Pentane) does not exceed 80 percent of the P-V valve pressure setting. If the pressure drop between the facility vapor connection and the shore facility's pressure sensor is known, it should be added to the pressure drop along this path to ensure that the total pressure drop does not exceed 80 percent of the P-V valve pressure setting.

7. Graph as Required by 46 CFR 39.30-1(b)(3):

See attached.

Table 1 Determination of Vapor-Air Mixture Density & Vapor Growth Rate

	CHRIS Code	Name	VCS Category	Liquid S.G.	*Vapor Press. @ 115 F (psia)	Vapor S.G.	Vapor-air Mixture Weight Density (lb/ft ³)	Vapor Growth Rate	Max. Loading Rate	Vapor Volumetric Flow Rate (bbl/hr)	Air Equivalent Volumetric Flow Rate (bbl/hr)	Pressure Drop to PV Valve in VCS (See Table 3) (psig)	Pressure Drop to Facility Connection in VCS (See Table 5) (psig)
1	ACN	Acrylonitrile	4	0.81	5.00	1.80	0.095	1.10	5,500	6050	6756	0.033	0.066
2	ACT	Acetone	1	0.79	10.00	2.00	0.123	1.20	5,500	6600	8393	0.052	0.102
3	ACP	Acetophenone	1	1.03	0.60	4.14	0.085	1.01	5,500	5566	5881	0.025	0.050
4	AND	Adiponitrile	1	0.95	0.01	3.73	0.076	1.00	5,500	5501	5506	0.022	0.044
5	AEC	Amyl acetate (all isomers)	1	0.88	0.33	0.10	0.075	1.01	5,500	5536	5485	0.022	0.044
6	AAI	Amyl Alcohol (iso-, n-, sec-, primary)	1	0.82	0.30	3.04	0.079	1.01	5,500	5533	5637	0.023	0.046
7	ATN	Acetonitrile	3	0.78	0.03	1.41	0.076	1.00	5,500	5503	5505	0.022	0.044
8	BAL	Benzyl Alcohol	1	1.05	0.10	3.73	0.077	1.00	5,500	5511	5557	0.023	0.045
9	BNZ	Benzene	1	0.88	4.50	2.80	0.114	1.25	5,500	6875	8420	0.052	0.103
10	BTX	Benzene, Toluene, Xylene mixtures (10% Benzene or more)	1	0.84	7.30	2.80	0.138	1.25	5,500	6875	9252	0.063	0.124
11	BAR	Butyl Acrylate (iso-, n-)	2	0.90	0.60	4.42	0.086	1.01	5,500	5566	5908	0.026	0.051
12	BAX	Butyl Acetate (all isomers)	1	0.87	0.60	4.00	0.085	1.01	5,500	5566	5867	0.025	0.050
13	IAL	Butyl Alcohol (iso-)	1	0.81	0.90	2.60	0.083	1.02	5,500	5599	5843	0.025	0.050
14	BAN	Butyl Alcohol (n-)	1	0.81	0.50	0.10	0.074	1.01	5,500	5555	5477	0.022	0.044
15	BAS	Butyl Alcohol (sec-)	1	0.81	1.30	2.60	0.086	1.03	5,500	5643	5994	0.026	0.052
16	BAT	Butyl Alcohol (tert-)	1	0.78	2.80	2.60	0.097	1.06	5,500	5808	6562	0.032	0.063
17	BPH	Butyl Benzyl Phthalate	1	1.12	0.01	10.80	0.077	1.00	5,500	5501	5518	0.022	0.044
18	BAD	iso-Butyraldehyde	1	0.80	7.80	2.50	0.131	1.16	5,500	6358	8344	0.051	0.101
19	BTR	n-Butyraldehyde	1	0.80	7.80	2.50	0.131	1.16	5,500	6358	8344	0.051	0.101
20	BUE	Butyl Toluene	1	0.85	0.10	5.11	0.078	1.00	5,500	5511	5580	0.023	0.045
21	CLS	Caprolactam Solutions	1	1.02	0.05	3.90	0.077	1.00	5,500	5506	5530	0.022	0.044
22	CCH	Cyclohexanone	1	0.95	0.20	3.40	0.078	1.00	5,500	5522	5603	0.023	0.046
23	CHA	Cyclohexylamine	1	0.87	0.62	3.42	0.083	1.01	5,500	5568	5820	0.025	0.049
24	CHX	Cyclohexane	1	0.78	4.50	2.90	0.116	1.09	5,500	5995	7410	0.040	0.080
25	CHN	Cyclohexanol	1	0.95	0.15	3.45	0.078	1.00	5,500	5517	5579	0.023	0.045
26	CPD	1,3-Cyclopentadiene dimer (molten)	2	0.69	0.25	4.55	0.080	1.01	5,500	5528	5677	0.024	0.047
27	CMP	p-Cymene	1	0.86	0.11	4.62	0.078	1.00	5,500	5512	5579	0.023	0.045
28	CRB	Chlorobenzene	1	1.11	0.80	3.88	0.087	1.02	5,500	5588	5972	0.026	0.052
29	CRS	Cresols	1	1.05	0.08	3.72	0.077	1.00	5,500	5509	5546	0.022	0.045
30	CUM	Cumene	1	0.86	0.60	4.20	0.085	1.01	5,500	5566	5887	0.025	0.050
31	IDA	Decaldehyde (iso-)	1	0.83	0.01	5.00	0.076	1.00	5,500	5501	5508	0.022	0.044
32	DAL	Decaldehyde (n-)	1	0.83	0.00	5.01	0.076	1.00	5,500	5500	5500	0.022	0.044
33	DCE	Decene	1	0.74	0.12	4.80	0.078	1.00	5,500	5513	5590	0.023	0.045
34	DAX	Decyl Alcohol (all isomers) (Decanol)	1	0.83	0.01	5.30	0.076	1.00	5,500	5501	5508	0.022	0.044
35	DBZ	Decylbenzene (n-)	1	0.86	0.01	7.52	0.076	1.00	5,500	5501	5512	0.022	0.044
36	DAA	Diacetone Alcohol	1	0.97	0.10	4.00	0.078	1.00	5,500	5511	5562	0.023	0.045
37	DCH	1,1-Dichloroethane	1	1.18	9.90	3.41	0.188	1.20	5,500	6589	10361	0.079	0.156
38	DPA	Dibutyl Phthalate (ortho-)	1	1.05	0.00	9.59	0.076	1.00	5,500	5500	5500	0.022	0.044
39	DEB	Diethylbenzene	1	0.87	0.08	4.62	0.078	1.00	5,500	5509	5558	0.023	0.045
40	DEG	Diethylene Glycol	1	1.12	0.01	3.66	0.076	1.00	5,500	5501	5506	0.022	0.044
41	DEN	Diethylamine	3	0.71	1.00	2.50	0.083	1.02	5,500	5610	5864	0.025	0.050
42	DBL	Diisobutylene	1	0.72	2.00	3.86	0.103	1.04	5,500	5720	6654	0.032	0.064
43	DIK	Diisobutyl Ketone	1	0.81	0.16	4.90	0.079	1.00	5,500	5518	5623	0.023	0.046
44	DIP	Diisopropanolamine	1	0.98	0.01	4.59	0.076	1.00	5,500	5501	5507	0.022	0.044
45	DIX	Diisopropylbenzene (all isomers)	1	0.86	0.03	5.60	0.077	1.00	5,500	5503	5527	0.022	0.044
46	DTL	Dimethyl Phthalate	1	1.19	0.00	6.69	0.076	1.00	5,500	5500	5500	0.022	0.044
47	DOP	Diocyl Phthalate	1	0.98	0.00	13.47	0.076	1.00	5,500	5500	5500	0.022	0.044
48	DPN	Dipentene	1	0.84	0.10	4.90	0.078	1.00	5,500	5511	5577	0.023	0.045
49	DIL	Diphenyl	1	0.99	0.01	5.31	0.076	1.00	5,500	5501	5508	0.022	0.044
50	DDO	Diphenyl, Diphenyl Ether Mixtures	1	1.07	0.01	5.86	0.076	1.00	5,500	5501	5509	0.022	0.044
51	DMF	Dimethylformamide	1	0.95	0.30	2.51	0.078	1.01	5,500	5533	5610	0.023	0.046
52	DPE	Diphenyl Ether	1	1.07	0.01	5.87	0.076	1.00	5,500	5501	5509	0.022	0.044
53	DPG	Dipropylene Glycol	1	1.03	0.07	4.63	0.077	1.00	5,500	5508	5551	0.023	0.045
54	DPX	1,1-, 1,2-, 1,3-Dichloropropane	3	1.16	6.30	3.90	0.162	1.13	5,500	6193	9034	0.060	0.119
55	DFE	Distillates Flashed Feed Stocks	1	0.75	2.30	3.40	0.102	1.05	5,500	5753	6661	0.032	0.064
56	DSR	Distillates Straight Run	1	0.73	2.30	3.40	0.102	1.05	5,500	5753	6661	0.032	0.064
57	DOZ	Dodecene (all isomers)	1	0.76	0.02	5.81	0.077	1.00	5,500	5502	5519	0.022	0.044
58	DDB	Dodecylbenzene	1	0.86	4.70	8.40	0.240	1.25	5,500	6875	12196	0.109	0.216
59	EAC	Ethyl Acrylate	2	0.93	2.00	3.50	0.100	1.04	5,500	5720	6543	0.031	0.062
60	EAI	2-Ethylhexyl acrylate	2	0.89	0.02	6.35	0.077	1.00	5,500	5502	5520	0.022	0.044
61	EEA	2-Ethoxyethyl acetate	1	0.97	0.02	4.70	0.077	1.00	5,500	5503	5517	0.022	0.044
62	ETG	Ethoxy Triglycol (crude)	1	1.02	0.00	6.14	0.076	1.00	5,500	5500	5500	0.022	0.044
63	ETA	Ethyl Acetate	1	0.90	4.50	3.04	0.119	1.09	5,500	5995	7504	0.041	0.082
64	EAA	Ethyl Acetoacetate	1	1.03	0.20	4.48	0.079	1.00	5,500	5522	5639	0.023	0.046
65	EAL	Ethyl Alcohol (Ethanol)	1	0.79	3.50	1.60	0.086	1.07	5,500	5885	6255	0.029	0.057
66	ETB	Ethyl Benzene	1	0.87	0.60	3.56	0.083	1.01	5,500	5566	5824	0.025	0.049
67	EBT	Ethyl Butanol	1	0.83	0.12	3.52	0.078	1.00	5,500	5513	5564	0.023	0.045
68	EBE	Ethyl tert-butyl ether	1	0.74	0.19	3.50	0.078	1.00	5,500	5521	5602	0.023	0.046

	CHRIS Code	Name	VCS Category	Liquid S.G.	*Vapor Press. @ 115 F (psia)	Vapor S.G.	Vapor-air Mixture Weight Density (lb/ft ³)	Vapor Growth Rate	Max. Loading Rate	Vapor Volumetric Flow Rate (bbl/hr)	Air Equivalent Volumetric Flow Rate (bbl/hr)	Pressure Drop to PV Valve in VCS (See Table 3) (psig)	Pressure Drop to Facility Connection in VCS (See Table 5) (psig)
69	EBR	Ethyl butyrate	1	0.88	1.00	4.00	0.090	1.02	5,500	5610	6107	0.027	0.054
70	ECY	Ethyl Cyclohexane	1	0.79	0.50	3.87	0.083	1.01	5,500	5555	5796	0.025	0.049
71	EDC	Ethylene dichloride	1	1.26	4.00	3.42	0.122	1.08	5,500	5940	7508	0.041	0.082
72	EGL	Ethylene Glycol	1	1.19	0.01	2.21	0.076	1.00	5,500	5501	5503	0.022	0.044
73	EMA	Ethylene Glycol Butyl Ether Acetate	1	0.94	0.05	5.52	0.077	1.00	5,500	5506	5544	0.022	0.045
74	EGY	Ethylene Glycol Diacetate	1	1.10	0.01	5.03	0.076	1.00	5,500	5501	5508	0.022	0.044
75	EPE	Ethylene Glycol Phenyl Ether	1	1.10	0.01	4.80	0.076	1.00	5,500	5501	5508	0.022	0.044
76	EPP	Ethyl-3-ethoxypropionate	1	0.95	0.01	5.00	0.076	1.00	5,500	5501	5510	0.022	0.044
77	EHX	2-Ethylhexanol	1	0.84	0.02	4.50	0.076	1.00	5,500	5502	5514	0.022	0.044
78	EPR	Ethyl Propionate	1	0.89	3.50	1.60	0.086	1.07	5,500	5885	6255	0.029	0.057
79	ETE	Ethyl Toluene	1	0.88	0.28	4.15	0.080	1.01	5,500	5531	5679	0.024	0.047
80	FAM	Formamide	1	1.13	0.10	1.55	0.076	1.00	5,500	5511	5520	0.022	0.044
81	FMS	Formaldehyde Solution	1	1.13	0.15	1.03	0.076	1.00	5,500	5517	5517	0.022	0.044
82	FAL	Furfuryl Alcohol	1	1.13	0.05	3.40	0.077	1.00	5,500	5506	5526	0.022	0.044
83	FFA	Furfural	1	1.20	0.15	3.31	0.078	1.00	5,500	5517	5575	0.023	0.045
84	GAK	Gasoline Blending Stocks: Alkylates	1	0.75	12.50	3.40	0.217	1.25	5,500	6875	11610	0.099	0.196
85	GRF	Gasoline Blending Stocks: Reformates	1	0.80	12.50	3.40	0.217	1.25	5,500	6875	11610	0.099	0.196
86	GAT	Gasolines: Automotive	1	0.74	12.50	3.40	0.217	1.25	5,500	6875	11610	0.099	0.196
87	GAV	Gasolines: Aviation	1	0.71	12.50	3.40	0.217	1.25	5,500	6875	11610	0.099	0.196
88	GCS	Gasolines: Casinghead	1	0.67	12.50	3.40	0.217	1.25	5,500	6875	11610	0.099	0.196
89	GPL	Gasolines: Polymer	1	0.75	12.50	3.40	0.217	1.25	5,500	6875	11610	0.099	0.196
90	GSR	Gasolines: StraightRun	1	0.75	12.50	3.40	0.217	1.25	5,500	6875	11610	0.099	0.196
91	GCR	Glycerine	1	1.26	0.00	3.17	0.076	1.00	5,500	5500	5500	0.022	0.044
92	HMX	Heptane (all isomers)	1	0.68	2.50	3.45	0.105	1.05	5,500	5775	6779	0.034	0.067
93	HEP	Heptonic Acid	1	0.92	0.01	4.49	0.076	1.00	5,500	5501	5507	0.022	0.044
94	HTX	Heptanol (all isomers)	1	0.82	0.04	4.00	0.077	1.00	5,500	5504	5525	0.022	0.044
95	HPX	Heptene (all isomers)	2	0.70	2.90	3.40	0.109	1.06	5,500	5819	6958	0.035	0.070
96	HXS	Hexane (all isomers)	1	0.66	7.00	3.00	0.142	1.14	5,500	6270	8561	0.054	0.106
97	HXO	Hexanoic Acid	1	0.93	0.01	4.00	0.076	1.00	5,500	5501	5506	0.022	0.044
98	HXN	Hexanol	1	0.82	1.00	3.52	0.088	1.02	5,500	5610	6031	0.027	0.053
99	HEX	Hexene (all isomers)	2	0.67	8.00	2.90	0.148	1.16	5,500	6380	8882	0.058	0.115
100	HXG	Hexylene Glycol	1	0.92	0.01	1.10	0.076	1.00	5,500	5501	5501	0.022	0.044
101	IPH	Isophorone	1	0.93	0.01	4.75	0.076	1.00	5,500	5501	5507	0.022	0.044
102	JPF	Jet Fuels: JP-4	1	0.81	3.40	4.00	0.124	1.07	5,500	5874	7499	0.041	0.082
103	JPV	Jet Fuels JP-5 (Kerosene. heavy)	1	0.82	0.10	4.00	0.078	1.00	5,500	5511	5562	0.023	0.045
104	KRS	Kerosene	1	0.81	0.15	4.50	0.079	1.00	5,500	5517	5605	0.023	0.046
105	MTT	Methyl Acetate	1	0.92	6.10	2.60	0.122	1.12	5,500	6171	7812	0.045	0.089
106	MAL	Methyl Alcohol (Methanol)	1	0.79	6.63	1.10	0.079	1.13	5,500	6229	6355	0.030	0.059
107	MAC	Methylamyl Acetate	1	0.86	0.33	4.97	0.082	1.01	5,500	5536	5756	0.024	0.048
108	MAA	Methylamyl Alcohol	1	0.81	0.43	3.52	0.081	1.01	5,500	5547	5730	0.024	0.048
109	MAK	Methylamyl Keytone	1	0.82	0.05	1.00	0.076	1.00	5,500	5506	5506	0.022	0.044
110	MAM	Methyl Acrylate	2	0.95	4.10	3.00	0.115	1.08	5,500	5951	7303	0.039	0.078
111	MBE	Methyl Tert-Butyl Ether (MTBE)	1	0.74	0.04	3.10	0.077	1.00	5,500	5504	5519	0.022	0.044
112	MBK	Methyl Butyl Ketone	1	0.81	0.97	3.50	0.088	1.02	5,500	5607	6012	0.026	0.053
113	MBU	Methyl Butyrate	1	0.90	1.26	3.53	0.091	1.03	5,500	5639	6168	0.028	0.055
114	MEK	Methyl Ethyl Ketone	1	0.80	4.50	2.50	0.108	1.09	5,500	5995	7135	0.037	0.074
115	MHK	Methyl Heptyl Ketone	1	0.83	0.06	4.90	0.077	1.00	5,500	5507	5546	0.023	0.045
116	MIK	Methyl Isobutyl Ketone	1	0.80	1.15	3.45	0.089	1.02	5,500	5627	6096	0.027	0.054
117	MMM	Methyl methacrylate	2	0.94	2.02	3.45	0.099	1.04	5,500	5722	6538	0.031	0.062
118	MNA	Methyl Naphthalene	1	1.02	0.01	4.91	0.076	1.00	5,500	5501	5508	0.022	0.044
119	MNS	Mineral Spirits	1	0.75	0.20	4.30	0.079	1.00	5,500	5522	5633	0.023	0.046
120	MPL	Morpholine	1	1.00	0.80	3.00	0.084	1.02	5,500	5588	5857	0.025	0.050
121	MRE	Myrcene	1	0.80	0.17	4.70	0.079	1.00	5,500	5519	5625	0.023	0.046
122	PTN	Naphtha: Petroleum	1	0.74	0.19	3.50	0.078	1.00	5,500	5521	5600	0.023	0.046
123	NSV	Naphtha: Solvent	1	0.87	0.20	3.50	0.078	1.00	5,500	5522	5607	0.023	0.046
124	NSS	Naphtha: Stoddard Solvent	1	0.78	0.20	4.30	0.079	1.00	5,500	5522	5633	0.023	0.046
125	NVM	Naphtha: VM&P	1	0.77	0.19	4.30	0.079	1.00	5,500	5521	5627	0.023	0.046
126	NAX	Nonane (all isomers)	1	0.72	0.27	4.40	0.080	1.01	5,500	5530	5684	0.024	0.047
127	NON	Nonene (all isomers)	2	0.73	0.35	4.30	0.082	1.01	5,500	5539	5733	0.024	0.048
128	NNS	Nonyl Alcohol (all isomers)	1	0.94	0.10	5.00	0.078	1.00	5,500	5511	5579	0.023	0.045
129	NNP	Nonyl Phenol	1	0.95	0.01	7.60	0.076	1.00	5,500	5501	5512	0.022	0.044
130	NPM	1-, 2-Nitropropane	1	0.99	1.05	3.06	0.086	1.02	5,500	5616	5979	0.026	0.052
131	OAX	Octane (all isomers)	1	0.70	0.79	3.90	0.087	1.02	5,500	5587	5969	0.026	0.052
132	OCX	Octanol (all isomers)	1	0.83	0.01	4.48	0.076	1.00	5,500	5501	5507	0.022	0.044
133	OTX	Octene (all isomers)	2	0.72	0.90	3.90	0.088	1.02	5,500	5599	6033	0.027	0.053
134	OTW	Oil, fuel: No. 2	1	0.88	0.56	8.00	0.095	1.01	5,500	5562	6198	0.028	0.056
135	OTD	Oil, fuel: No. 2-D	1	0.90	0.69	3.40	0.084	1.01	5,500	5576	5853	0.025	0.050
136	OFR	Oil, fuel: No. 4	1	0.90	0.15	3.40	0.078	1.00	5,500	5517	5577	0.023	0.045
137	OFV	Oil, fuel: No. 5	1	0.94	0.15	3.40	0.078	1.00	5,500	5517	5577	0.023	0.045
138	OSX	Oil, fuel: No. 6	1	0.95	0.15	3.40	0.078	1.00	5,500	5517	5577	0.023	0.045
139	OIL	Oil, misc: Crude	1	0.95	0.15	3.40	0.078	1.25	5,500	6875	6951	0.035	0.070
140	ODS	Oil, Misc: Diesel	1	0.90	0.69	3.40	0.084	1.01	5,500	5576	5854	0.025	0.050
141	OLB	Oil, Misc: Lubricating	1	0.90	0.15	1.00	0.076	1.00	5,500	5517	5517	0.022	0.044

Vapor Recovery Calculations

	CHRIS Code	Name	VCS Category	Liquid S.G.	*Vapor Press. @ 115 F (psia)	Vapor S.G.	Vapor-air Mixture Weight Density (lb/ft ³)	Vapor Growth Rate	Max. Loading Rate	Vapor Volumetric Flow Rate (bbl/hr)	Air Equivalent Volumetric Flow Rate (bbl/hr)	Pressure Drop to PV Valve in VCS (See Table 3) (psig)	Pressure Drop to Facility Connection in VCS (See Table 5) (psig)
142	ORL	Oil, Misc: Residual	1	1.02	0.15	1.00	0.076	1.00	5,500	5517	5517	0.022	0.044
143	OTB	Oil, Misc: Turbine	1	0.87	0.30	5.40	0.082	1.01	5,500	5533	5754	0.024	0.048
144	PTY	Pentane (all isomers)	5	0.63	27.00	2.50	0.350	1.54	5,500	8470	18150	0.241	0.479
145	PTE	Pentene (all isomers)	5	0.64	24.95	2.40	0.310	1.50	5,500	8245	16640	0.203	0.402
146	PIN	Pinene	1	0.86	0.38	4.70	0.083	1.01	5,500	5542	5777	0.024	0.048
147	PLB	Polybutene	1	0.91	0.01	1.00	0.076	1.00	5,500	5501	5501	0.022	0.044
148	PGC	Polypropylene Glycol	1	1.01	0.10	1.00	0.076	1.00	5,500	5511	5511	0.022	0.044
149	IAC	Propyl Acetate (iso-)	1	0.89	1.80	3.52	0.097	1.04	5,500	5698	6447	0.030	0.060
150	PAT	Propyl Acetate (n-)	1	0.00	1.85	3.52	0.098	1.04	5,500	5704	6472	0.031	0.061
151	IPA	Propyl Alcohol (iso-)	1	0.79	3.00	2.07	0.091	1.06	5,500	5830	6382	0.030	0.059
152	PAL	Propyl Alcohol (n-)	1	0.80	1.20	2.07	0.082	1.02	5,500	5632	5851	0.025	0.050
153	PBY	Propylbenzene (all isomers)	1	0.86	0.20	4.14	0.079	1.00	5,500	5522	5628	0.023	0.046
154	IPX	iso-Propylcyclohexane	1	0.80	0.01	4.35	0.076	1.00	5,500	5501	5507	0.022	0.044
155	PPG	Propylene Glycol	1	1.04	0.01	2.62	0.076	1.00	5,500	5501	5504	0.022	0.044
156	PGN	Propylene Glycol Methyl Ether Acetate	1	0.92	0.70	3.11	0.083	1.01	5,500	5577	5826	0.025	0.049
157	PTT	Propylene Tetramer	1	0.29	0.02	1.00	0.076	1.00	5,500	5502	5502	0.022	0.044
158	SFL	Sulfolane	1	1.26	0.01	4.14	0.076	1.00	5,500	5501	5506	0.022	0.044
159	STY	Styrene	2	0.92	0.40	3.60	0.081	1.01	5,500	5544	5719	0.024	0.048
160	TTG	Tetraethylene Glycol	1	1.20	0.01	6.70	0.076	1.00	5,500	5501	5511	0.022	0.044
161	THN	Tetrahydronaphthalene	1	0.97	0.04	4.56	0.077	1.00	5,500	5504	5529	0.022	0.044
162	TOL	Toluene	1	0.87	1.50	3.14	0.091	1.03	5,500	5665	6201	0.028	0.056
163	TCN	1,2,3-Trichloropropane	3	1.39	0.15	5.60	0.079	1.00	5,500	5517	5633	0.023	0.046
164	TCP	Tricresyl Phosphate (less than 1% of ortho)	1	1.16	0.01	12.69	0.077	1.00	5,500	5501	5521	0.022	0.044
165	TEB	Triethylbenzene	1	0.86	0.02	5.60	0.077	1.00	5,500	5502	5518	0.022	0.044
166	TEN	Triethylamine	3	0.73	2.50	3.49	0.105	1.05	5,500	5775	6795	0.034	0.067
167	TEG	Triethylene Glycol	1	1.12	0.01	5.17	0.076	1.00	5,500	5501	5508	0.022	0.044
168	TPS	Triethyl Phosphate	1	1.07	0.03	6.28	0.077	1.00	5,500	5503	5530	0.022	0.044
169	TRE	Trimethylbenzene (all isomers)	1	0.89	0.14	4.20	0.078	1.00	5,500	5515	5588	0.023	0.045
170	TRP	Trixylenyl Phosphate	1	1.16	0.00	14.20	0.076	1.00	5,500	5500	5500	0.022	0.044
171	THF	Tetrahydrofuran	1	0.89	8.50	1.35	0.090	1.17	5,500	6435	7001	0.036	0.071
172	UDC	Undecene	1	0.75	0.05	5.32	0.077	1.00	5,500	5506	5542	0.022	0.045
173	UND	Undecyl Alcohol	1	0.84	0.01	5.94	0.076	1.00	5,500	5501	5509	0.022	0.044
174	VAM	Vinyl Acetate	2	0.94	5.80	2.97	0.130	1.12	5,500	6138	8015	0.047	0.093
175	XLX	Xylenes (ortho-, meta-, para-)	1	0.89	0.51	3.68	0.083	1.01	5,500	5556	5786	0.024	0.049

max = 0.350 1.54 max = 0.241 0.479

Notes: 1. The above data is sourced from the USCG CHRIS Manual (Ref. 7) & from various manufacturer's MSDS's.

Table 2 Calculation of Maximum Liquid Transfer Rate as Imposed by the Capacity of the Cargo Tank Venting System

Note: Darcy's equation will be used to estimate the pressure drop of the vapor-air mixture through the vent piping from the farthest tank in terms of equivalent pipe length (#1P) to the P-V valve. Equivalent length for this path is calculated using Crane's Technical Paper 410 (Ref 4) and Cameron Hydraulic Data handbook (Ref 9).

Calculate equivalent lengths of pipe:

- a. Pipe run #1
 Description: 8" Branch (Exp trunk to vapor stack)
 Pipe size, nominal: 8" sch. 40 pipe
 Pipe ID (inches): 7.98

Item	Description	Size (in)	Qty	Unit Equivalent Length (ft)	Total Equivalent Length (ft)
1	Entrance	8	1	23.3	23.3
2	Straight Pipe	8	1	54.0	54.0
3	Tee, branch	8	2	39.9	79.8
4	Tee, flow	8	1	13.3	13.3
5					
6					
	Sum (pipe run #1)				170.4

- b. Pipe run #2
 Description: 6" branch at P-V valve
 Pipe size, nominal: 6" sch. 40 pipe
 Pipe ID (inches): 6.07

Item	Description	Size (in)	Qty	Unit Equivalent Length (ft)	Total Equivalent Length (ft)
1	Straight Pipe	6	1	3.0	3.0
2	Reducer (8x6)	6	1	6.4	6.4
	Sum (pipe run #2)				9.4

Table 3 Calculation of Maximum Liquid Transfer Rate as Imposed by the Capacity of the Cargo Tank Venting System (Continued)

A. Calculate pressure drop using Darcy's equation:

CHRIS Code	Name	Vapor-air Mixture Weight Density (from Table 1) (lb/ft ³)	Liquid Transfer Rate (filling) (bbl/hr)	Vapor Growth Rate	Pipe run #1			Pipe run #2			Pressure Drop (Total) (psig)	Air Equiv. Volumetric Flow Rate (bbl/hr)
					Vapor Volumetric Flow Rate (bbl/hr)	Mean Velocity (ft/s)	Pressure Drop (pipe run #1) (psig)	Vapor Volumetric Flow Rate (bbl/hr)	Mean Velocity (ft/s)	Pressure Drop (pipe run #2) (psig)		
					Description: 8" Branch (Exp trunk to vapor stack) Pipe ID: 7.98 (in) Equiv. Pipe Length (table 2a): 170.4 (feet) Darcy friction factor: 0.014			Description: 6" branch at P-V valve Pipe ID: 6.07 (in) Equiv. Pipe Length (table 2b): 9.4 (feet) Darcy friction factor: 0.015				
1	ACN Acrylonitrile	0.095	5,500	1.100	6050	27.16	0.027	6050	46.95	0.006	0.033	6756
2	ACT Acetone	0.123	5,500	1.200	6600	29.63	0.042	6600	51.22	0.010	0.052	8393
3	ACP Acetophenone	0.085	5,500	1.012	5566	24.99	0.021	5566	43.19	0.005	0.025	5881
4	AND Adiponitrile	0.076	5,500	1.000	5501	24.70	0.018	5501	42.69	0.004	0.022	5506
5	AEC Amyl acetate (all isomers)	0.075	5,500	1.007	5536	24.86	0.018	5536	42.96	0.004	0.022	5485
6	AAI Amyl Alcohol (iso-, n-, sec-, primary)	0.079	5,500	1.006	5533	24.84	0.019	5533	42.94	0.004	0.023	5637
7	ATN Acetonitrile	0.076	5,500	1.001	5503	24.71	0.018	5503	42.71	0.004	0.022	5505
8	BAL Benzyl Alcohol	0.077	5,500	1.002	5511	24.74	0.018	5511	42.77	0.004	0.023	5557
9	BNZ Benzene	0.114	5,500	1.250	6875	30.87	0.042	6875	53.35	0.010	0.052	8420
10	BTX Benzene, Toluene, Xylene mixtures (10% Benzen	0.138	5,500	1.250	6875	30.87	0.051	6875	53.35	0.012	0.063	9252
11	BAR Butyl Acrylate (iso-, n-)	0.086	5,500	1.012	5566	24.99	0.021	5566	43.19	0.005	0.026	5908
12	BAX Butyl Acetate (all isomers)	0.085	5,500	1.012	5566	24.99	0.020	5566	43.19	0.005	0.025	5867
13	IAL Butyl Alcohol (iso-)	0.083	5,500	1.018	5599	25.14	0.020	5599	43.45	0.005	0.025	5843
14	BAN Butyl Alcohol (n-)	0.074	5,500	1.010	5555	24.94	0.018	5555	43.11	0.004	0.022	5477
15	BAS Butyl Alcohol (sec-)	0.086	5,500	1.026	5643	25.34	0.021	5643	43.79	0.005	0.026	5994
16	BAT Butyl Alcohol (tert-)	0.097	5,500	1.056	5808	26.08	0.026	5808	45.07	0.006	0.032	6562
17	BPH Butyl Benzyl Phthalate	0.077	5,500	1.000	5501	24.70	0.018	5501	42.69	0.004	0.022	5518
18	BAD iso-Butylaldehyde	0.131	5,500	1.156	6358	28.55	0.041	6358	49.34	0.010	0.051	8344
19	BTR n-Butylaldehyde	0.131	5,500	1.156	6358	28.55	0.041	6358	49.34	0.010	0.051	8344
20	BUE Butyl Toluene	0.078	5,500	1.002	5511	24.74	0.018	5511	42.77	0.004	0.023	5580
21	CLS Caprolactam Solutions	0.077	5,500	1.001	5506	24.72	0.018	5506	42.72	0.004	0.022	5530
22	CCH Cyclohexanone	0.078	5,500	1.004	5522	24.79	0.019	5522	42.85	0.004	0.023	5603
23	CHA Cyclohexylamine	0.083	5,500	1.012	5568	25.00	0.020	5568	43.21	0.005	0.025	5820
24	CHX Cyclohexane	0.116	5,500	1.090	5995	26.92	0.033	5995	46.52	0.008	0.040	7410
25	CHN Cyclohexanol	0.078	5,500	1.003	5517	24.77	0.018	5517	42.81	0.004	0.023	5579
26	CPD 1,3-Cyclopentadiene dimer (molten)	0.080	5,500	1.005	5528	24.82	0.019	5528	42.90	0.004	0.024	5677
27	CMP p-Cymene	0.078	5,500	1.002	5512	24.75	0.018	5512	42.78	0.004	0.023	5579
28	CRB Chlorobenzene	0.087	5,500	1.016	5588	25.09	0.021	5588	43.36	0.005	0.026	5972
29	CRS Cresols	0.077	5,500	1.002	5509	24.73	0.018	5509	42.75	0.004	0.022	5546
30	CUM Cumene	0.085	5,500	1.012	5566	24.99	0.021	5566	43.19	0.005	0.025	5887
31	IDA Decaldehyde (iso-)	0.076	5,500	1.000	5501	24.70	0.018	5501	42.69	0.004	0.022	5508
32	DAL Decaldehyde (n-)	0.076	5,500	1.000	5500	24.70	0.018	5500	42.68	0.004	0.022	5500
33	DCE Decene	0.078	5,500	1.002	5513	24.75	0.019	5513	42.78	0.004	0.023	5590
34	DAX Decyl Alcohol (all isomers) (Decanol)	0.076	5,500	1.000	5501	24.70	0.018	5501	42.69	0.004	0.022	5508
35	DBZ Decylbenzene (n-)	0.076	5,500	1.000	5501	24.70	0.018	5501	42.69	0.004	0.022	5512
36	DA A Diacetone Alcohol	0.078	5,500	1.002	5511	24.74	0.018	5511	42.77	0.004	0.023	5562
37	DCH 1,1-Dichloroethane	0.188	5,500	1.198	6589	29.59	0.064	6589	51.13	0.015	0.079	10361
38	DPA Dibutyl Phthalate (ortho-)	0.076	5,500	1.000	5500	24.70	0.018	5500	42.68	0.004	0.022	5500
39	DEB Diethylbenzene	0.078	5,500	1.002	5509	24.73	0.018	5509	42.75	0.004	0.023	5558
40	DEG Diethylene Glycol	0.076	5,500	1.000	5501	24.70	0.018	5501	42.69	0.004	0.022	5506
41	DEN Diethylamine	0.083	5,500	1.020	5610	25.19	0.020	5610	43.54	0.005	0.025	5864
42	DBL Diisobutylene	0.103	5,500	1.040	5720	25.68	0.026	5720	44.39	0.006	0.032	6654
43	DIK Diisobutyl Ketone	0.079	5,500	1.003	5518	24.77	0.019	5518	42.82	0.004	0.023	5623
44	DIP Diisopropanolamine	0.076	5,500	1.000	5501	24.70	0.018	5501	42.69	0.004	0.022	5507
45	DIX Diisopropylbenzene (all isomers)	0.077	5,500	1.001	5503	24.71	0.018	5503	42.71	0.004	0.022	5527
46	DTL Dimethyl Phthalate	0.076	5,500	1.000	5500	24.70	0.018	5500	42.68	0.004	0.022	5500
47	DOP Diocyl Phthalate	0.076	5,500	1.000	5500	24.70	0.018	5500	42.68	0.004	0.022	5500
48	DPN Dipentene	0.078	5,500	1.002	5511	24.74	0.018	5511	42.77	0.004	0.023	5577
49	DIL Diphenyl	0.076	5,500	1.000	5501	24.70	0.018	5501	42.69	0.004	0.022	5508
50	DDO Diphenyl, Diphenyl Ether Mixtures	0.076	5,500	1.000	5501	24.70	0.018	5501	42.69	0.004	0.022	5509
51	DMF Dimethylformamide	0.078	5,500	1.006	5533	24.84	0.019	5533	42.94	0.004	0.023	5610
52	DPE Diphenyl Ether	0.076	5,500	1.000	5501	24.70	0.018	5501	42.69	0.004	0.022	5509
53	DPG Dipropylene Glycol	0.077	5,500	1.001	5508	24.73	0.018	5508	42.74	0.004	0.023	5551
54	DPX 1,1-, 1,2-, 1,3-Dichloropropane	0.162	5,500	1.126	6193	27.81	0.048	6193	48.06	0.011	0.060	9034
55	DDF Distillates Flashed Feed Stocks	0.102	5,500	1.046	5753	25.83	0.026	5753	44.65	0.006	0.032	6661
56	DSR Distillates Straight Run	0.102	5,500	1.046	5753	25.83	0.026	5753	44.65	0.006	0.032	6661
57	DOZ Dodecene (all isomers)	0.077	5,500	1.000	5502	24.71	0.018	5502	42.70	0.004	0.022	5519
58	DDB Dodecylbenzene	0.240	5,500	1.250	6875	30.87	0.088	6875	53.35	0.021	0.109	12196
59	EAC Ethyl Acrylate	0.100	5,500	1.040	5720	25.68	0.025	5720	44.39	0.006	0.031	6543
60	EAI 2-Ethylhexyl acrylate	0.077	5,500	1.000	5502	24.71	0.018	5502	42.70	0.004	0.022	5520
61	EAA 2-Ethoxyethyl acetate	0.077	5,500	1.000	5503	24.71	0.018	5503	42.70	0.004	0.022	5517
62	ETG Ethoxy Triglycol (crude)	0.076	5,500	1.000	5500	24.70	0.018	5500	42.68	0.004	0.022	5500
63	ETA Ethyl Acetate	0.119	5,500	1.090	5995	26.92	0.033	5995	46.52	0.008	0.041	7504
64	EAA Ethyl Acetoacetate	0.079	5,500	1.004	5522	24.79	0.019	5522	42.85	0.004	0.023	5639
65	EAL Ethyl Alcohol (Ethanol)	0.086	5,500	1.070	5885	26.42	0.023	5885	45.67	0.005	0.029	6255
66	ETB Ethyl Benzene	0.083	5,500	1.012	5566	24.99	0.020	5566	43.19	0.005	0.025	5824
67	EBT Ethyl Butanol	0.078	5,500	1.002	5513	24.75	0.018	5513	42.78	0.004	0.023	5564
68	EBE Ethyl tert-butyl ether	0.078	5,500	1.004	5521	24.79	0.019	5521	42.85	0.004	0.023	5602
69	EBR Ethyl butyrate	0.090	5,500	1.020	5610	25.19	0.022	5610	43.54	0.005	0.027	6107
70	ECY Ethyl Cyclohexane	0.083	5,500	1.010	5555	24.94	0.020	5555	43.11	0.005	0.025	5796
71	EDC Ethylene dichloride	0.122	5,500	1.080	5940	26.67	0.033	5940	46.10	0.008	0.041	7508
72	EGL Ethylene Glycol	0.076	5,500	1.000	5501	24.70	0.018	5501	42.69	0.004	0.022	5503
73	EMA Ethylene Glycol Butyl Ether Acetate	0.077	5,500	1.001	5506	24.72	0.018	5506	42.72	0.004	0.022	5544
74	EGY Ethylene Glycol Diacetate	0.076	5,500	1.000	5501	24.70	0.018	5501	42.69	0.004	0.022	5508
75	EPE Ethylene Glycol Phenyl Ether	0.076	5,500	1.000	5501	24.70	0.018	5501	42.69	0.004	0.022	5508
76	EEP Ethyl-3-ethoxypropionate	0.076	5,500	1.000	5501	24.70	0.018	5501	42.69	0.004	0.022	5510
77	EHX 2-Ethylhexanol	0.076	5,500	1.000	5502	24.71	0.018	5502	42.70	0.004	0.022	5514
78	EPR Ethyl Propionate	0.086	5,500	1.070	5885	26.42	0.023	5885	45.67	0.005	0.029	6255
79	ETE Ethyl Toluene	0.080	5,500	1.006	5531	24.83	0.019	5531	42.92	0.004	0.024	5679
80	FAM Formamide	0.076	5,500	1.002	5511	24.74	0.018	5511	42.77	0.004	0.022	5520
81	FMS Formaldehyde Solution	0.076										

Pipe run #1	8" Branch (Exp trunk to vapor stack)	7.98 (in)	170.4 (feet)	0.014
Description:	8" Branch (Exp trunk to vapor stack)	7.98 (in)	170.4 (feet)	0.014
Pipe ID:		7.98 (in)		
Equiv. Pipe Length (table 2a):			170.4 (feet)	
Darcy friction factor:				0.014

Pipe run #2	6" branch at P-V valve	6.07 (in)	9.4 (feet)	0.015
Description:	6" branch at P-V valve	6.07 (in)	9.4 (feet)	0.015
Pipe ID:		6.07 (in)		
Equiv. Pipe Length (table 2b):			9.4 (feet)	
Darcy friction factor:				0.015

CHRIS Code	Name	Vapor-air Mixture Weight Density (from Table 1) (lb/ft ³)	Liquid Transfer Rate (filling) (bbl/hr)	Vapor Growth Rate	Vapor Volumetric Flow Rate (bbl/hr)	Mean Velocity (ft/s)	Pressure Drop (pipe run #1) (psig)	Vapor Volumetric Flow Rate (bbl/hr)	Mean Velocity (ft/s)	Pressure Drop (pipe run #2) (psig)	Pressure Drop (Total) (psig)	Air Equiv. Volumetric Flow Rate (bbl/hr)	
100	HXG	Hexylene Glycol	0.076	5,500	1.000	5501	24.70	0.018	5501	42.69	0.004	0.022	5501
101	IPH	Isophorone	0.076	5,500	1.000	5501	24.70	0.018	5501	42.69	0.004	0.022	5507
102	JPF	Jet Fuels: JP-4	0.124	5,500	1.068	5874	26.37	0.033	5874	45.58	0.008	0.041	7499
103	JPV	Jet Fuels JP-5 (Kerosene. heavy)	0.078	5,500	1.002	5511	24.74	0.018	5511	42.77	0.004	0.023	5562
104	KRS	Kerosene	0.079	5,500	1.003	5517	24.77	0.019	5517	42.81	0.004	0.023	5605
105	MTT	Methyl Acetate	0.122	5,500	1.122	6171	27.71	0.036	6171	47.89	0.008	0.045	7812
106	MAL	Methyl Alcohol (Methanol)	0.079	5,500	1.133	6229	27.97	0.024	6229	48.34	0.006	0.030	6355
107	MAC	Methylamyl Acetate	0.082	5,500	1.007	5536	24.86	0.020	5536	42.96	0.005	0.024	5756
108	MAA	Methylamyl Alcohol	0.081	5,500	1.009	5547	24.91	0.019	5547	43.05	0.005	0.024	5730
109	MAK	Methylamyl Keytone	0.076	5,500	1.001	5506	24.72	0.018	5506	42.72	0.004	0.022	5506
110	MAM	Methyl Acrylate	0.115	5,500	1.082	5951	26.72	0.032	5951	46.18	0.007	0.039	7303
111	MBE	Methyl Tert-Butyl Ether (MTBE)	0.077	5,500	1.001	5504	24.72	0.018	5504	42.72	0.004	0.022	5519
112	MBK	Methyl Butyl Ketone	0.088	5,500	1.019	5607	25.17	0.021	5607	43.51	0.005	0.026	6012
113	MBU	Methyl Butyrate	0.091	5,500	1.025	5639	25.32	0.023	5639	43.76	0.005	0.028	6168
114	MEK	Methyl Ethyl Ketone	0.108	5,500	1.090	5995	26.92	0.030	5995	46.52	0.007	0.037	7135
115	MHK	Methyl Heptyl Ketone	0.077	5,500	1.001	5507	24.73	0.018	5507	42.73	0.004	0.023	5546
116	MIK	Methyl Isobutyl Ketone	0.089	5,500	1.023	5627	25.26	0.022	5627	43.66	0.005	0.027	6096
117	MMM	Methyl methacrylate	0.099	5,500	1.040	5722	25.69	0.025	5722	44.41	0.006	0.031	6538
118	MNA	Methyl Naphthalene	0.076	5,500	1.000	5501	24.70	0.018	5501	42.69	0.004	0.022	5508
119	MNS	Mineral Spirits	0.079	5,500	1.004	5522	24.79	0.019	5522	42.85	0.004	0.023	5633
120	MPL	Morpholine	0.084	5,500	1.016	5588	25.09	0.020	5588	43.36	0.005	0.025	5857
121	MRE	Myrcene	0.079	5,500	1.003	5519	24.78	0.019	5519	42.83	0.004	0.023	5625
122	PTN	Naphtha: Petroleum	0.078	5,500	1.004	5521	24.79	0.019	5521	42.84	0.004	0.023	5600
123	NSV	Naphtha: Solvent	0.078	5,500	1.004	5522	24.79	0.019	5522	42.85	0.004	0.023	5607
124	NSS	Naphtha: Stoddard Solvent	0.079	5,500	1.004	5522	24.79	0.019	5522	42.85	0.004	0.023	5633
125	NVM	Naphtha: VM&P	0.079	5,500	1.004	5521	24.79	0.019	5521	42.84	0.004	0.023	5627
126	NAX	Nonane (all isomers)	0.080	5,500	1.005	5530	24.83	0.019	5530	42.91	0.004	0.024	5684
127	NON	Nonene (all isomers)	0.082	5,500	1.007	5539	24.87	0.020	5539	42.98	0.005	0.024	5733
128	NNS	Nonyl Alcohol (all isomers)	0.078	5,500	1.002	5511	24.74	0.018	5511	42.77	0.004	0.023	5579
129	NNP	Nonyl Phenol	0.076	5,500	1.000	5501	24.70	0.018	5501	42.69	0.004	0.022	5512
130	NPM	1-, 2-Nitropropane	0.086	5,500	1.021	5616	25.21	0.021	5616	43.58	0.005	0.026	5979
131	OAX	Octane (all isomers)	0.087	5,500	1.016	5587	25.09	0.021	5587	43.36	0.005	0.026	5969
132	OCX	Octanol (all isomers)	0.076	5,500	1.000	5501	24.70	0.018	5501	42.69	0.004	0.022	5507
133	OTX	Octene (all isomers)	0.088	5,500	1.018	5599	25.14	0.022	5599	43.45	0.005	0.027	6033
134	OTW	Oil, fuel: No. 2	0.095	5,500	1.011	5562	24.97	0.023	5562	43.16	0.005	0.028	6198
135	OTD	Oil, fuel: No. 2-D	0.084	5,500	1.014	5576	25.04	0.020	5576	43.27	0.005	0.025	5853
136	OFR	Oil, fuel: No. 4	0.078	5,500	1.003	5517	24.77	0.018	5517	42.81	0.004	0.023	5577
137	OFV	Oil, fuel: No. 5	0.078	5,500	1.003	5517	24.77	0.018	5517	42.81	0.004	0.023	5577
138	OSX	Oil, fuel: No. 6	0.078	5,500	1.003	5517	24.77	0.018	5517	42.81	0.004	0.023	5577
139	OIL	Oil, misc: Crude	0.078	5,500	1.250	6875	30.87	0.029	6875	53.35	0.007	0.035	6951
140	ODS	Oil, Misc: Diesel	0.084	5,500	1.014	5576	25.04	0.020	5576	43.27	0.005	0.025	5854
141	OLB	Oil, Misc: Lubricating	0.076	5,500	1.003	5517	24.77	0.018	5517	42.81	0.004	0.022	5517
142	ORL	Oil, Misc: Residual	0.076	5,500	1.003	5517	24.77	0.018	5517	42.81	0.004	0.022	5517
143	OTB	Oil, Misc: Turbine	0.082	5,500	1.006	5533	24.84	0.020	5533	42.94	0.005	0.024	5754
144	PTY	Pentane (all isomers)	0.350	5,500	1.540	8470	38.03	0.196	8470	65.73	0.045	0.241	18150
145	PTE	Pentene (all isomers)	0.310	5,500	1.499	8245	37.02	0.164	8245	63.98	0.038	0.203	16640
146	PIN	Pinene	0.083	5,500	1.008	5542	24.88	0.020	5542	43.01	0.005	0.024	5777
147	PLB	Polybutene	0.076	5,500	1.000	5501	24.70	0.018	5501	42.69	0.004	0.022	5501
148	PGC	Polypropylene Glycol	0.076	5,500	1.002	5511	24.74	0.018	5511	42.77	0.004	0.022	5511
149	IAC	Propyl Acetate (iso-)	0.097	5,500	1.036	5698	25.58	0.025	5698	44.22	0.006	0.030	6447
150	PAT	Propyl Acetate (n-)	0.098	5,500	1.037	5704	25.61	0.025	5704	44.26	0.006	0.031	6472
151	IPA	Propyl Alcohol (iso-)	0.091	5,500	1.060	5830	26.18	0.024	5830	45.24	0.006	0.030	6382
152	PAL	Propyl Alcohol (n-)	0.082	5,500	1.024	5632	25.29	0.020	5632	43.71	0.005	0.025	5851
153	PBY	Propylbenzene (all isomers)	0.079	5,500	1.004	5522	24.79	0.019	5522	42.85	0.004	0.023	5628
154	IPX	iso-Propylcyclohexane	0.076	5,500	1.000	5501	24.70	0.018	5501	42.69	0.004	0.022	5507
155	PPG	Propylene Glycol	0.076	5,500	1.000	5501	24.70	0.018	5501	42.69	0.004	0.022	5504
156	PGN	Propylene Glycol Methyl Ether Acetate	0.083	5,500	1.014	5577	25.04	0.020	5577	43.28	0.005	0.025	5826
157	PTT	Propylene Tetramer	0.076	5,500	1.000	5502	24.71	0.018	5502	42.70	0.004	0.022	5502
158	SFL	Sulfolane	0.076	5,500	1.000	5501	24.70	0.018	5501	42.69	0.004	0.022	5506
159	STY	Styrene	0.081	5,500	1.008	5544	24.89	0.019	5544	43.02	0.005	0.024	5719
160	TTG	Tetraethylene Glycol	0.076	5,500	1.000	5501	24.70	0.018	5501	42.69	0.004	0.022	5511
161	THN	Tetrahydronaphthalene	0.077	5,500	1.001	5504	24.72	0.018	5504	42.72	0.004	0.022	5529
162	TOL	Toluene	0.091	5,500	1.030	5665	25.44	0.023	5665	43.96	0.005	0.028	6201
163	TCN	1,2,3-Trichloropropane	0.079	5,500	1.003	5517	24.77	0.019	5517	42.81	0.004	0.023	5633
164	TCP	Tricresyl Phosphate (less than 1% of ortho isomer)	0.077	5,500	1.000	5501	24.70	0.018	5501	42.69	0.004	0.022	5521
165	TEB	Triethylbenzene	0.077	5,500	1.000	5502	24.71	0.018	5502	42.70	0.004	0.022	5518
166	TEN	Triethylamine	0.105	5,500	1.050	5775	25.93	0.027	5775	44.82	0.006	0.034	6795
167	TEG	Triethylene Glycol	0.076	5,500	1.000	5501	24.70	0.018	5501	42.69	0.004	0.022	5508
168	TPS	Triethyl Phosphate	0.077	5,500	1.001	5503	24.71	0.018	5503	42.71	0.004	0.022	5530
169	TRE	Trimethylbenzene (all isomers)	0.078	5,500	1.003	5515	24.76	0.019	5515	42.80	0.004	0.023	5588
170	TRP	Trixylenyl Phosphate	0.076	5,500	1.000	5500	24.70	0.018	5500	42.68	0.004	0.022	5500
171	THF	Tetrahydrofuran	0.090	5,500	1.170	6435	28.89	0.029	6435	49.94	0.007	0.036	7001
172	UDC	Undecene	0.077	5,500	1.001	5506	24.72	0.018	5506	42.72	0.004	0.022	5542
173	LND	Undecyl Alcohol	0.076	5,500	1.000	5501	24.70	0.018	5501	42.69	0.004	0.022	5509
174	VAM	Vinyl Acetate	0.130	5,500	1.116	6138	27.56	0.038	6138	47.63	0.009	0.047	8015
175	XLX	Xylenes (ortho-, meta-, para-)	0.083	5,500	1.010	5556	24.95	0.020	5556	43.12	0.005	0.024	5786

max = 0.241 18150

Greatest pressure drop to P-V valve: 0.24 (psig) Pentane (all isomers)

High velocity P-V valve pressure setting: 1.50 (psig)
 Back pressure imposed by P-V valve @ highest flow rate: 2.64 (psig)
 Total back pressure imposed on cargo tank by venting: 2.88 (psig)
 Max design working pressure of tanks: 3.00 (psig)

Conclusion: At the maximum cargo loading rate, the total back pressure imposed by the tank venting system does not exceed the maximum design working pressure of the tanks.

B. Check vacuum relieving capacity at maximum discharge rate:

Opening vacuum setting for PV Valve: 0.5 (psig)

Maximum discharge rate (total): 4300 (bbl/hr)
 Corresponding vacuum at max discharge rate: (see attached PV valve flow capacity curve) 0.47 (psig)

Table 4 Calculation of the Maximum Liquid Transfer Rate as Imposed by the pressure drop between the most remote tank and the facility vapor connection (Ref: 46 CFR 39.30-1(d)(3):

Note: Darcy's equation will be used to estimate the pressure drop of the vapor-air mixture through the vent piping from the farthest tank in terms of equivalent pipe length (#1P) to the facility connection. Equivalent length for this path is calculated using Crane's Technical Paper 410 (Ref. 4) and Cameron Hydraulic Data handbook (Ref. 9)

Calculate equivalent lengths of pipe:

- a. Pipe run #1
 Description: 8" Piping
 Pipe size, nominal: 8" sch. 40 pipe
 Pipe ID (inches): 7.98

Item	Description	Size (in)	Qty	Unit Equivalent Length (ft)	Total Equivalent Length (ft)
1	Entrance	8	1	23.3	23.3
2	Straight Pipe	8	1	195.0	195.0
3	Tee, branch	8	2	39.9	79.8
4	Tee, run	8	3	13.3	39.9
5	Elbow, 45 deg.	8	2	10.2	20.4
6	Valve, Gate	8	1	8.6	8.6
7	Hose	8	1	50.0	50.0
	Sum (pipe run #1)				417.0

Table 5 Calculation of the Maximum Liquid Transfer Rate as Imposed by the pressure drop between the most remote tank and the facility vapor connection (Ref: 46 CFR 39.30-1(d)(3) (continued):

1. Calculate pressure drop using Darcy's equation:

Pipe run #1	
Description:	8" Piping
Pipe ID:	7.98 (in)
Equivalent Length of Pipe (from Table 4a):	417.0 (feet)
Darcy friction factor:	0.014

	CHRIS Code	Name	Vapor-air Mixture Weight Density (from Table 1) (lb/ft ³)	Liquid Transfer Rate (filling) (bbl/hr)	Vapor Growth Rate	Vapor Volumetric Flow Rate (bbl/hr)	Mean Velocity (ft/s)	Pressure Drop (pipe run #1) (psig)	Pressure Drop (Total) (psig)	Air Equivalent Volumetric Flow Rate (bbl/hr)
1	ACN	Acrylonitrile	0.095	5,500	1.100	6050	27.16	0.066	0.066	6756
2	ACT	Acetone	0.123	5,500	1.200	6600	29.63	0.102	0.102	8393
3	ACP	Acetophenone	0.085	5,500	1.012	5566	24.99	0.050	0.050	5881
4	AND	Adiponitrile	0.076	5,500	1.000	5501	24.70	0.044	0.044	5506
5	AEC	Amyl acetate (all isomers)	0.075	5,500	1.007	5536	24.86	0.044	0.044	5485
6	AAI	Amyl Alcohol (iso-, n-, sec-, primary)	0.079	5,500	1.006	5533	24.84	0.046	0.046	5637
7	ATN	Acetonitrile	0.076	5,500	1.001	5503	24.71	0.044	0.044	5505
8	BAL	Benzyl Alcohol	0.077	5,500	1.002	5511	24.74	0.045	0.045	5557
9	BNZ	Benzene	0.114	5,500	1.250	6875	30.87	0.103	0.103	8420
10	BTX	Benzene, Toluene, Xylene mixtures (10% Benzene)	0.138	5,500	1.250	6875	30.87	0.124	0.124	9252
11	BAR	Butyl Acrylate (iso-, n-)	0.086	5,500	1.012	5566	24.99	0.051	0.051	5908
12	BAX	Butyl Acetate (all isomers)	0.085	5,500	1.012	5566	24.99	0.050	0.050	5867
13	IAL	Butyl Alcohol (iso-)	0.083	5,500	1.018	5599	25.14	0.050	0.050	5843
14	BAN	Butyl Alcohol (n-)	0.074	5,500	1.010	5555	24.94	0.044	0.044	5477
15	BAS	Butyl Alcohol (sec-)	0.086	5,500	1.026	5643	25.34	0.052	0.052	5994
16	BAT	Butyl Alcohol (tert-)	0.097	5,500	1.056	5808	26.08	0.063	0.063	6562
17	BPH	Butyl Benzyl Phthalate	0.077	5,500	1.000	5501	24.70	0.044	0.044	5518
18	BAD	iso-Butyraldehyde	0.131	5,500	1.156	6358	28.55	0.101	0.101	8344
19	BTR	n-Butyraldehyde	0.131	5,500	1.156	6358	28.55	0.101	0.101	8344
20	BUE	Butyl Toluene	0.078	5,500	1.002	5511	24.74	0.045	0.045	5580
21	CLS	Caprolactam Solutions	0.077	5,500	1.001	5506	24.72	0.044	0.044	5530
22	CCH	Cyclohexanone	0.078	5,500	1.004	5522	24.79	0.046	0.046	5603
23	CHA	Cyclohexylamine	0.083	5,500	1.012	5568	25.00	0.049	0.049	5820
24	CHX	Cyclohexane	0.116	5,500	1.090	5995	26.92	0.080	0.080	7410
25	CHN	Cyclohexanol	0.078	5,500	1.003	5517	24.77	0.045	0.045	5579
26	CPD	1,3-Cyclopentadiene dimer (molten)	0.080	5,500	1.005	5528	24.82	0.047	0.047	5677
27	CMP	p-Cymene	0.078	5,500	1.002	5512	24.75	0.045	0.045	5579
28	CRB	Chlorobenzene	0.087	5,500	1.016	5588	25.09	0.052	0.052	5972
29	CRS	Cresols	0.077	5,500	1.002	5509	24.73	0.045	0.045	5546
46	DTL	Dimethyl Phthalate	0.076	5,500	1.000	5500	24.70	0.044	0.044	5500
47	DOP	Diocyl Phthalate	0.076	5,500	1.000	5500	24.70	0.044	0.044	5500
48	DPN	Dipentene	0.078	5,500	1.002	5511	24.74	0.045	0.045	5577
49	DIL	Diphenyl	0.076	5,500	1.000	5501	24.70	0.044	0.044	5508
50	DDO	Diphenyl, Diphenyl Ether Mixtures	0.076	5,500	1.000	5501	24.70	0.044	0.044	5509
51	DMF	Dimethylformamide	0.078	5,500	1.006	5533	24.84	0.046	0.046	5610
52	DPE	Diphenyl Ether	0.076	5,500	1.000	5501	24.70	0.044	0.044	5509
53	DPG	Dipropylene Glycol	0.077	5,500	1.001	5508	24.73	0.045	0.045	5551
54	DPX	1,1-, 1,2-, 1,3-Dichloropropane	0.162	5,500	1.126	6193	27.81	0.119	0.119	9034
55	DFF	Distillates Flashed Feed Stocks	0.102	5,500	1.046	5753	25.83	0.064	0.064	6661
56	DSR	Distillates Straight Run	0.102	5,500	1.046	5753	25.83	0.064	0.064	6661
57	DOZ	Dodecene (all isomers)	0.077	5,500	1.000	5502	24.71	0.044	0.044	5519
58	DDB	Dodecylbenzene	0.240	5,500	1.250	6875	30.87	0.216	0.216	12196
59	EAC	Ethyl Acrylate	0.100	5,500	1.040	5720	25.68	0.062	0.062	6543
60	EAI	2-Ethylhexyl acrylate	0.077	5,500	1.000	5502	24.71	0.044	0.044	5520
61	EEA	2-Ethoxyethyl acetate	0.077	5,500	1.000	5503	24.71	0.044	0.044	5517
62	ETG	Ethoxy Triglycol (crude)	0.076	5,500	1.000	5500	24.70	0.044	0.044	5500
63	ETA	Ethyl Acetate	0.119	5,500	1.090	5995	26.92	0.082	0.082	7504
64	EA	Ethyl Acetoacetate	0.079	5,500	1.004	5522	24.79	0.046	0.046	5639
65	EAL	Ethyl Alcohol (Ethanol)	0.086	5,500	1.070	5885	26.42	0.057	0.057	6255
66	ETB	Ethyl Benzene	0.083	5,500	1.012	5566	24.99	0.049	0.049	5824
67	EBT	Ethyl Butanol	0.078	5,500	1.002	5513	24.75	0.045	0.045	5564
68	EBE	Ethyl tert-butyl ether	0.078	5,500	1.004	5521	24.79	0.046	0.046	5602
69	EBR	Ethyl butyrate	0.090	5,500	1.020	5610	25.19	0.054	0.054	6107
70	ECY	Ethyl Cyclohexane	0.083	5,500	1.010	5555	24.94	0.049	0.049	5796
71	EDC	Ethylene dichloride	0.122	5,500	1.080	5940	26.67	0.082	0.082	7508
72	EGL	Ethylene Glycol	0.076	5,500	1.000	5501	24.70	0.044	0.044	5503
73	EMA	Ethylene Glycol Butyl Ether Acetate	0.077	5,500	1.001	5506	24.72	0.045	0.045	5544
74	EGY	Ethylene Glycol Diacetate	0.076	5,500	1.000	5501	24.70	0.044	0.044	5508
75	EPE	Ethylene Glycol Phenyl Ether	0.076	5,500	1.000	5501	24.70	0.044	0.044	5508
76	EEP	Ethyl-3-ethoxypropionate	0.076	5,500	1.000	5501	24.70	0.044	0.044	5510
77	EHX	2-Ethylhexanol	0.076	5,500	1.000	5502	24.71	0.044	0.044	5514
78	EPR	Ethyl Propionate	0.086	5,500	1.070	5885	26.42	0.057	0.057	6255
79	ETE	Ethyl Toluene	0.080	5,500	1.006	5531	24.83	0.047	0.047	5679
80	FAM	Formamide	0.076	5,500	1.002	5511	24.74	0.044	0.044	5520
81	FMS	Formaldehyde Solution	0.076	5,500	1.003	5517	24.77	0.044	0.044	5517
82	FAL	Furfuryl Alcohol	0.077	5,500	1.001	5506	24.72	0.044	0.044	5526
83	FFA	Furfural	0.078	5,500	1.003	5517	24.77	0.045	0.045	5575
84	GAK	Gasoline Blending Stocks: Alkylates	0.217	5,500	1.250	6875	30.87	0.196	0.196	11610
85	GRF	Gasoline Blending Stocks: Reformates	0.217	5,500	1.250	6875	30.87	0.196	0.196	11610
86	GAT	Gasolines: Automotive	0.217	5,500	1.250	6875	30.87	0.196	0.196	11610
87	GAV	Gasolines: Aviation	0.217	5,500	1.250	6875	30.87	0.196	0.196	11610
88	GCS	Gasolines: Casinghead	0.217	5,500	1.250	6875	30.87	0.196	0.196	11610
89	GPL	Gasolines: Polymer	0.217	5,500	1.250	6875	30.87	0.196	0.196	11610
90	GSR	Gasolines: StraightRun	0.217	5,500	1.250	6875	30.87	0.196	0.196	11610
91	GCR	Glycerine	0.076	5,500	1.000	5500	24.70	0.044	0.044	5500
92	HMX	Heptane (all isomers)	0.105	5,500	1.050	5775	25.93	0.067	0.067	6779
93	HEP	Heptonic Acid	0.076	5,500	1.000	5501	24.70	0.044	0.044	5507
94	HTX	Heptanol (all isomers)	0.077	5,500	1.001	5504	24.72	0.044	0.044	5525
95	HPX	Heptene (all isomers)	0.109	5,500	1.058	5819	26.13	0.070	0.070	6958
96	HXS	Hexane (all isomers)	0.142	5,500	1.140	6270	28.15	0.106	0.106	8561
97	HXO	Hexanoic Acid	0.076	5,500	1.000	5501	24.70	0.044	0.044	5506
98	HXN	Hexanol	0.088	5,500	1.020	5610	25.19	0.053	0.053	6031
99	HEX	Hexene (all isomers)	0.148	5,500	1.160	6380	28.65	0.115	0.115	8882
100	HXG	Hexylene Glycol	0.076	5,500	1.000	5501	24.70	0.044	0.044	5501
101	IPH	Isophorone	0.076	5,500	1.000	5501	24.70	0.044	0.044	5507
102	JPF	Jet Fuels: JP-4	0.124	5,500	1.068	5874	26.37	0.082	0.082	7499
103	JPV	Jet Fuels JP-5 (Kerosene, heavy)	0.078	5,500	1.002	5511	24.74	0.045	0.045	5562
104	KRS	Kerosene	0.079	5,500	1.003	5517	24.77	0.046	0.046	5605
105	MTT	Methyl Acetate	0.122	5,500	1.122	6171	27.71	0.089	0.089	7812
106	MAL	Methyl Alcohol (Methanol)	0.079	5,500	1.133	6229	27.97	0.059	0.059	6355
107	MAC	Methylamyl Acetate	0.082	5,500	1.007	5536	24.86	0.048	0.048	5756
108	MAA	Methylamyl Alcohol	0.081	5,500	1.009	5547	24.91	0.048	0.048	5730
109	MAK	Methylamyl Keytone	0.076	5,500	1.001	5506	24.72	0.044	0.044	5506
110	MAM	Methyl Acrylate	0.115	5,500	1.082	5951	26.72	0.078	0.078	7303

Pipe run #1			
Description:	8" Piping		
Pipe ID:	7.98 (in)		
Equivalent Length of Pipe (from Table 4a):	417.0 (feet)		
Darcy friction factor:	0.014		

111	MBE	Methyl Tert-Butyl Ether (MTBE)	0.077	5,500	1.001	5504	24.72	0.044	0.044	5519
112	MBK	Methyl Butyl Ketone	0.088	5,500	1.019	5607	25.17	0.053	0.053	6012
113	MBU	Methyl Butyrate	0.091	5,500	1.025	5639	25.32	0.055	0.055	6168
114	MEK	Methyl Ethyl Ketone	0.108	5,500	1.090	5995	26.92	0.074	0.074	7135
115	MHK	Methyl Heptyl Ketone	0.077	5,500	1.001	5507	24.73	0.045	0.045	5546
116	MIK	Methyl Isobutyl Ketone	0.089	5,500	1.023	5627	25.26	0.054	0.054	6096
117	MMM	Methyl methacrylate	0.099	5,500	1.040	5722	25.69	0.062	0.062	6538
118	MNA	Methyl Naphthalene	0.076	5,500	1.000	5501	24.70	0.044	0.044	5508
119	MNS	Mineral Spirits	0.079	5,500	1.004	5522	24.79	0.046	0.046	5633
120	MPL	Morpholine	0.084	5,500	1.016	5588	25.09	0.050	0.050	5857
121	MRE	Myrcene	0.079	5,500	1.003	5519	24.78	0.046	0.046	5625
122	PTN	Naphtha: Petroleum	0.078	5,500	1.004	5521	24.79	0.046	0.046	5600
123	NSV	Naphtha: Solvent	0.078	5,500	1.004	5522	24.79	0.046	0.046	5607
124	NSS	Naphtha: Stoddard Solvent	0.079	5,500	1.004	5522	24.79	0.046	0.046	5633
125	NVM	Naphtha: VM&P	0.079	5,500	1.004	5521	24.79	0.046	0.046	5627
126	NAX	Nonane (all isomers)	0.080	5,500	1.005	5530	24.83	0.047	0.047	5684
127	NON	Nonene (all isomers)	0.082	5,500	1.007	5539	24.87	0.048	0.048	5733
128	NNS	Nonyl Alcohol (all isomers)	0.078	5,500	1.002	5511	24.74	0.045	0.045	5579
129	NNP	Nonyl Phenol	0.076	5,500	1.000	5501	24.70	0.044	0.044	5512
130	NPM	1-, 2-Nitropropane	0.086	5,500	1.021	5616	25.21	0.052	0.052	5979
131	OAX	Octane (all isomers)	0.087	5,500	1.016	5587	25.09	0.052	0.052	5969
132	OCX	Octanol (all isomers)	0.076	5,500	1.000	5501	24.70	0.044	0.044	5507
133	OTX	Octene (all isomers)	0.088	5,500	1.018	5599	25.14	0.053	0.053	6033
134	OTW	Oil, fuel: No. 2	0.095	5,500	1.011	5562	24.97	0.056	0.056	6198
135	OTD	Oil, fuel: No. 2-D	0.084	5,500	1.014	5576	25.04	0.050	0.050	5853
136	OFR	Oil, fuel: No. 4	0.078	5,500	1.003	5517	24.77	0.045	0.045	5577
137	OFV	Oil, fuel: No. 5	0.078	5,500	1.003	5517	24.77	0.045	0.045	5577
138	OSX	Oil, fuel: No. 6	0.078	5,500	1.003	5517	24.77	0.045	0.045	5577
139	OIL	Oil, misc: Crude	0.078	5,500	1.250	6875	30.87	0.070	0.070	6951
140	ODS	Oil, Misc: Diesel	0.084	5,500	1.014	5576	25.04	0.050	0.050	5854
141	OLB	Oil, Misc: Lubricating	0.076	5,500	1.003	5517	24.77	0.044	0.044	5517
142	ORL	Oil, Misc: Residual	0.076	5,500	1.003	5517	24.77	0.044	0.044	5517
143	OTB	Oil, Misc: Turbine	0.082	5,500	1.006	5533	24.84	0.048	0.048	5754
144	PTY	Pentane (all isomers)	0.350	5,500	1.540	8470	38.03	0.479	0.479	18150
145	PTE	Pentene (all isomers)	0.310	5,500	1.499	8245	37.02	0.402	0.402	16640
146	PIN	Pinene	0.083	5,500	1.008	5542	24.88	0.048	0.048	5777
147	PLB	Polybutene	0.076	5,500	1.000	5501	24.70	0.044	0.044	5501
148	PGC	Polypropylene Glycol	0.076	5,500	1.002	5511	24.74	0.044	0.044	5511
149	IAC	Propyl Acetate (iso-)	0.097	5,500	1.036	5698	25.58	0.060	0.060	6447
150	PAT	Propyl Acetate (n-)	0.098	5,500	1.037	5704	25.61	0.061	0.061	6472
151	IPA	Propyl Alcohol (iso-)	0.091	5,500	1.060	5830	26.18	0.059	0.059	6382
152	PAL	Propyl Alcohol (n-)	0.082	5,500	1.024	5632	25.29	0.050	0.050	5851
153	PBY	Propylbenzene (all isomers)	0.079	5,500	1.004	5522	24.79	0.046	0.046	5628
154	IPX	iso-Propylcyclohexane	0.076	5,500	1.000	5501	24.70	0.044	0.044	5507
155	PPG	Propylene Glycol	0.076	5,500	1.000	5501	24.70	0.044	0.044	5504
156	PGN	Propylene Glycol Methyl Ether Acetate	0.083	5,500	1.014	5577	25.04	0.049	0.049	5826
157	PTT	Propylene Tetramer	0.076	5,500	1.000	5502	24.71	0.044	0.044	5502
158	SFL	Sulfolane	0.076	5,500	1.000	5501	24.70	0.044	0.044	5506
159	STY	Styrene	0.081	5,500	1.008	5544	24.89	0.048	0.048	5719
160	TTG	Tetraethylene Glycol	0.076	5,500	1.000	5501	24.70	0.044	0.044	5511
161	THN	Tetrahydronaphthalene	0.077	5,500	1.001	5504	24.72	0.044	0.044	5529
162	TOL	Toluene	0.091	5,500	1.030	5665	25.44	0.056	0.056	6201
163	TCN	1,2,3-Trichloropropane	0.079	5,500	1.003	5517	24.77	0.046	0.046	5633
164	TCP	Tricresyl Phosphate (less than 1% of ortho isomer)	0.077	5,500	1.000	5501	24.70	0.044	0.044	5521
165	TEB	Triethylbenzene	0.077	5,500	1.000	5502	24.71	0.044	0.044	5518
166	TEN	Triethylamine	0.105	5,500	1.050	5775	25.93	0.067	0.067	6795
167	TEG	Triethylene Glycol	0.076	5,500	1.000	5501	24.70	0.044	0.044	5508
168	TPS	Triethyl Phosphate	0.077	5,500	1.001	5503	24.71	0.044	0.044	5530
169	TRE	Trimethylbenzene (all isomers)	0.078	5,500	1.003	5515	24.76	0.045	0.045	5588
170	TRP	Trixylenyl Phosphate	0.076	5,500	1.000	5500	24.70	0.044	0.044	5500
171	THF	Tetrahydrofuran	0.090	5,500	1.170	6435	28.89	0.071	0.071	7001
172	UDC	Undecene	0.077	5,500	1.001	5506	24.72	0.045	0.045	5542
173	UND	Undecyl Alcohol	0.076	5,500	1.000	5501	24.70	0.044	0.044	5509
174	VAM	Vinyl Acetate	0.130	5,500	1.116	6138	27.56	0.093	0.093	8015
175	XLX	Xylenes (ortho-, meta-, para-)	0.083	5,500	1.010	5556	24.95	0.049	0.049	5786
max = 0.479 18150										

2. Compare pressure drop to P-V valve pressure settings:
 - a. High-velocity P-V Valve pressure setting: 1.50 (psig)
 - b. Cargo tank P-V Valve pressure setting: 1.50 (psig)
 - c. 80% of lowest P-V Valve Pressure Setting: 1.20 (psig)
 - d. Highest Pressure Drop from Tank to Facility Connection: 0.48 (psig)
 - e. Max Allowable Back Pressure at Facility Connection: 0.72 (psig)

0.48 (psig) for Pentane (all isomers)

Conclusion:
 For the cargo with the highest pressure drop (Pentane), the pressure drop is 0.48 psig. This, when added to the back pressure at the facility vapor connection must not exceed 80% of the pressure setting of any P-V valve in the cargo tank venting system. Therefore, the maximum allowable back pressure at the shore facility must not exceed 0.72 psig when loading with Pentane at the maximum liquid transfer rate (5,500 bbl/hr).

Graphs as required by 46 CFR 39.30-1(b)(3)

Curve of Loading Rate vs. Pressure Drop

Conrad Hulls C890, H407

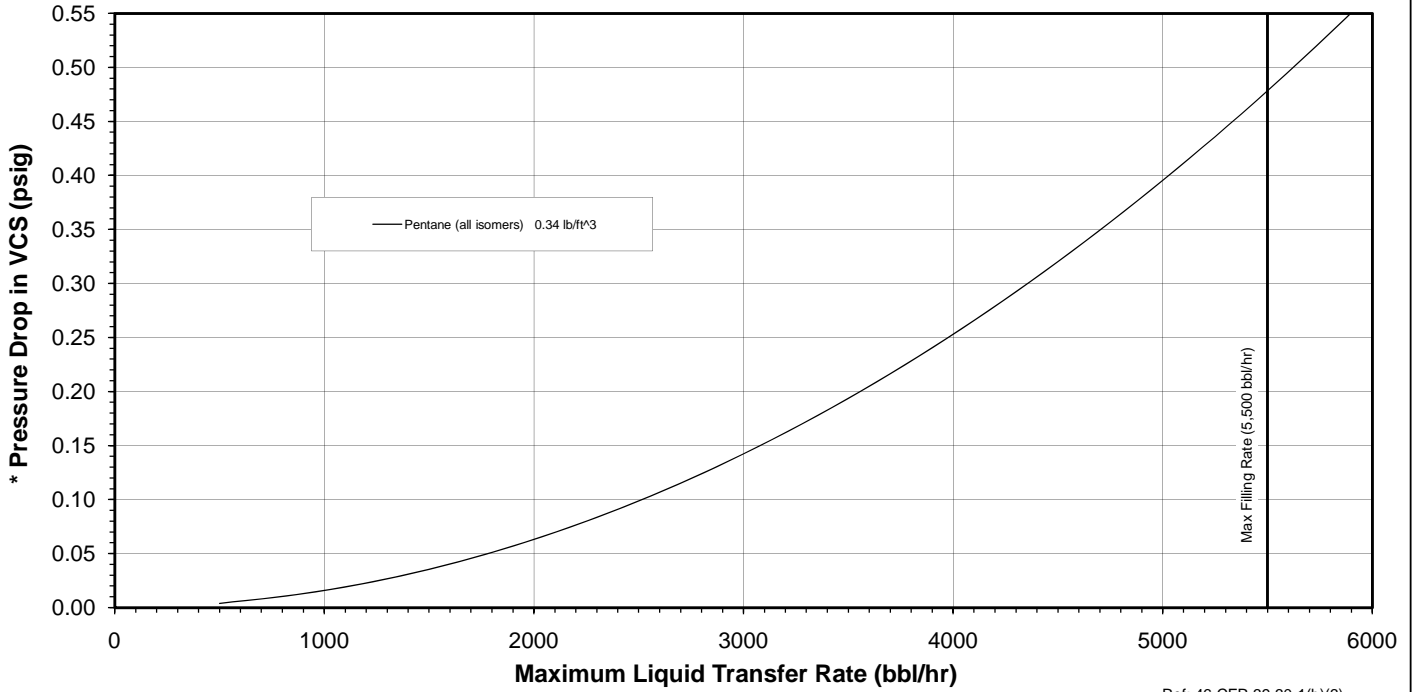

Curve of Allowable Back Pressure at Facility Connection

Conrad Hulls C890, H407

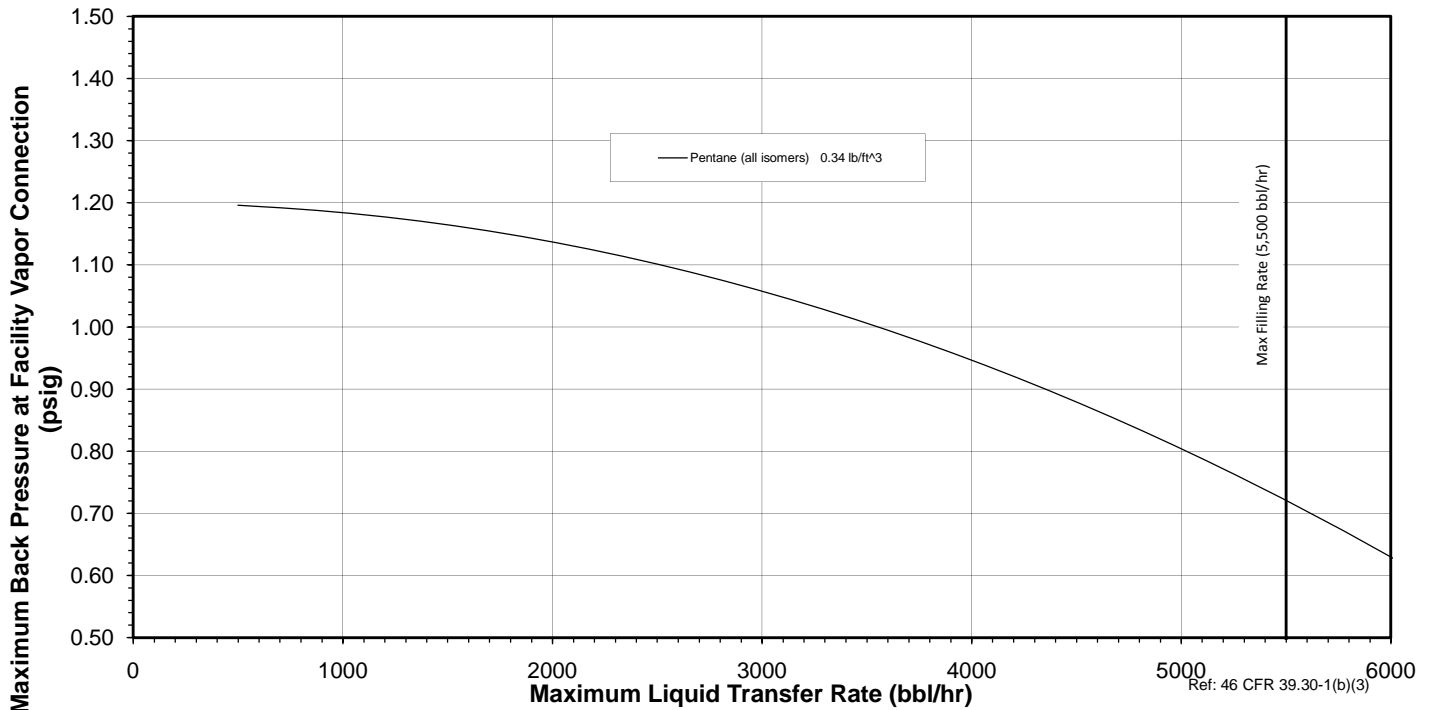

Conrad C890 / Orange H407
Calculation of Overfill Alarm Set Point
(Cargo Tank No. 1 P/S)

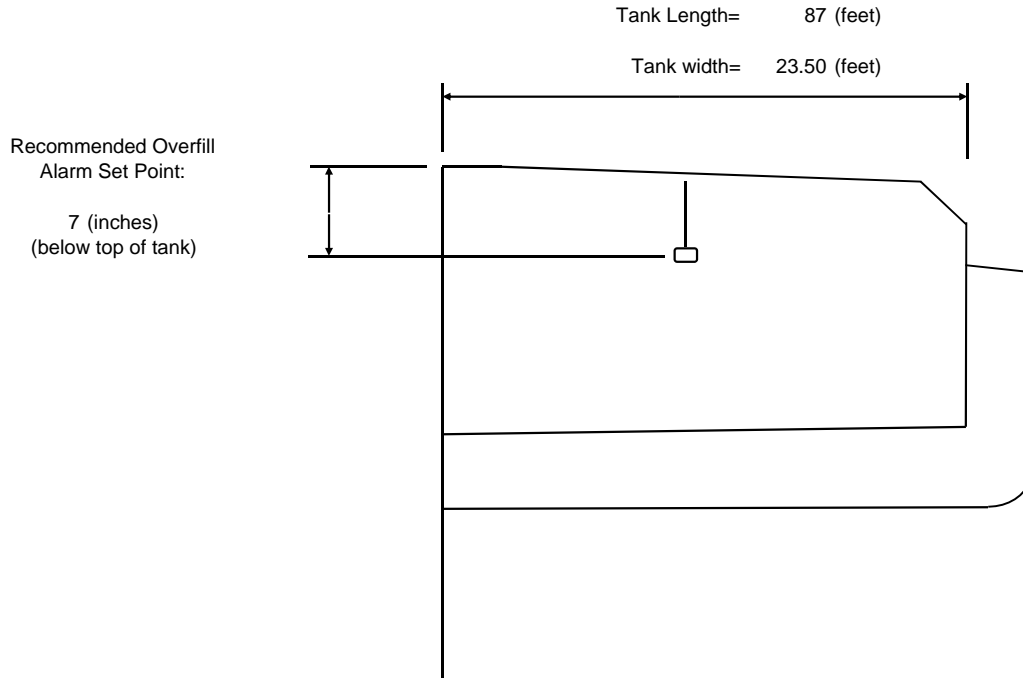

Maximum (per tank) Cargo Loading Rate	=	5,500 (bbl/hr)	
	=	91.67 (bbl/min)	
Minimum allowable time from alarm to overflow	=	60 (sec)	
Required volume above overfill alarm set point	=	91.7 (bbl)	
Capacity to deck at CL (17'-8" ABL) =		5278 BBL	
Capacity to 7" below dk at CL (17'-1" ABL) =		5168 BBL	
Volume above alarm =		110.1 BBL	RESULT OK
**Recommended set point of	=	7 (inches)	[Based on 98% full tank]

**Note: Or 98.5%, whichever is lower (to comply with 33CFR155.775)	
Capacity at 98.5% =	5199 BBL
Dist from TT at CL =	0.49 ft.

Conrad C890 / Orange H407
Calculation of Overfill Alarm Set Point
(Cargo Tank No. 2 P/S)

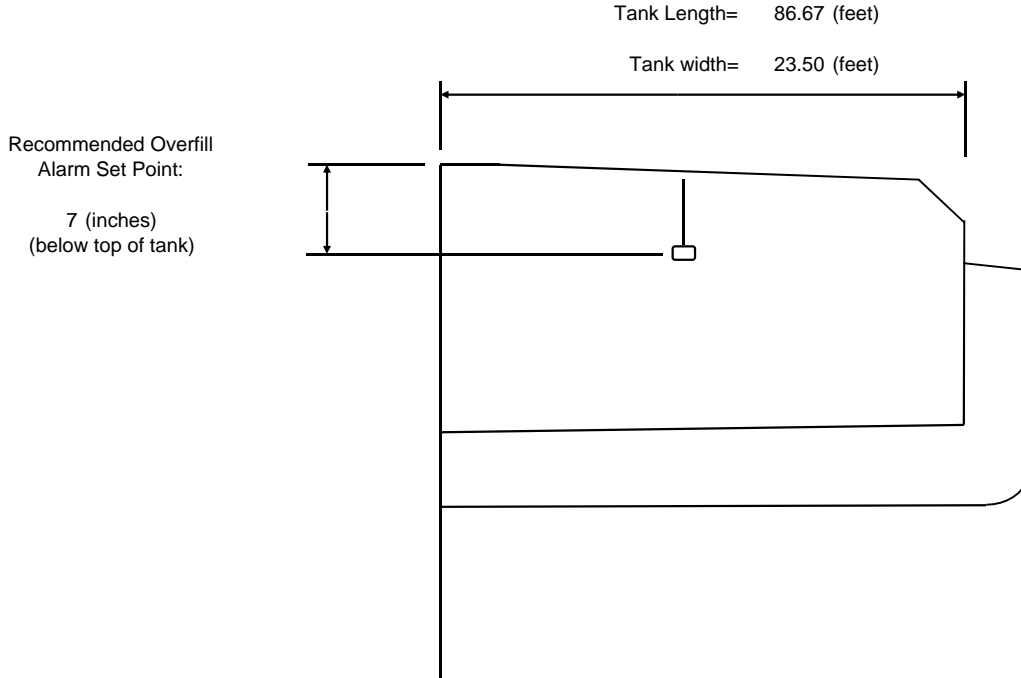

Maximum (per tank) Cargo Loading Rate	=	5,500 (bbl/hr)	
	=	91.67 (bbl/min)	
Minimum allowable time from alarm to overflow	=	60 (sec)	
Required volume above overfill alarm set point	=	91.7 (bbl)	
Capacity to deck at CL (17'-8" ABL) =		5258 BBL	
Capacity to 7" below dk at CL (17'-1" ABL) =		5149 BBL	
Volume above alarm =		109.6 BBL	RESULT OK
**Recommended set point of	=	7 (inches)	[Based on 98% full tank]

**Note: Or 98.5%, whichever is lower (to comply with 33CFR155.775)	
Capacity at 98.5% =	5179 BBL
Dist from TT at CL =	0.49 ft.

Conrad C890 / Orange H407
Calculation of Overfill Alarm Set Point
(Cargo Tank No. 3 P/S)

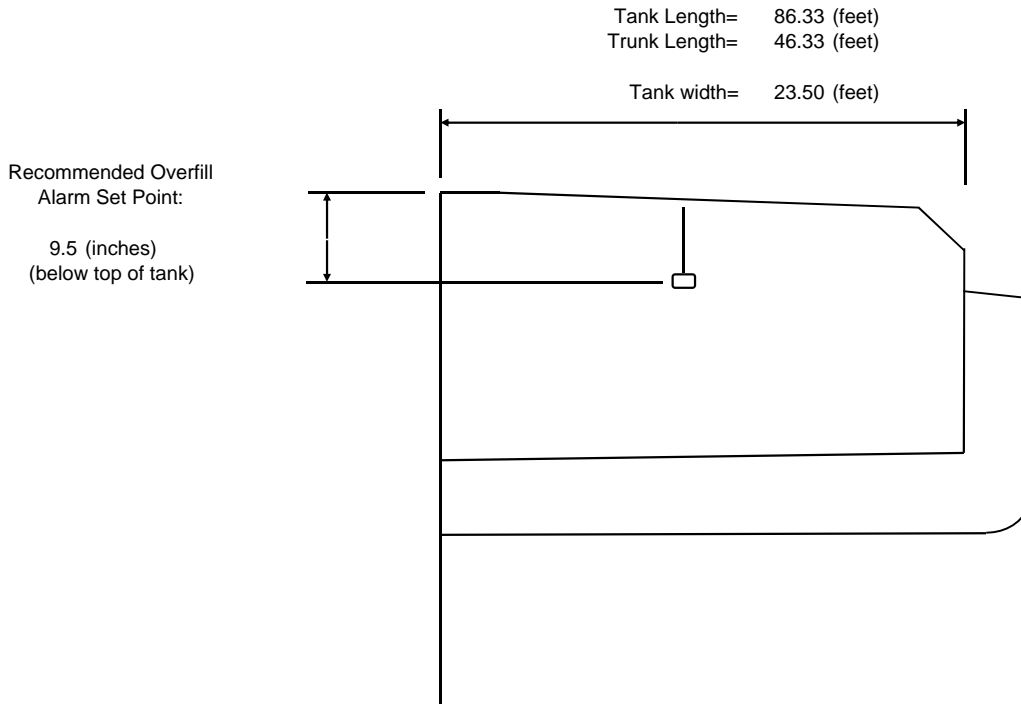

Maximum (per tank) Cargo Loading Rate	=	5,500 (bbl/hr)	
	=	91.67 (bbl/min)	
Minimum allowable time from alarm to overflow	=	60 (sec)	
Required volume above overfill alarm set point	=	91.7 (bbl)	
Capacity to deck at CL (17'-8" ABL) =		4409 BBL	
Capacity to 9.5" below dk at CL (16'-10.5" ABL) =		4314 BBL	
Volume above alarm =		95.1 BBL	RESULT OK
**Recommended set point of	=	9.5 (inches)	

**Note: Or 98.5%, whichever is lower (to comply with 33CFR155.775)	
Capacity at 98.5% =	4343 BBL
Dist from TT at CL =	0.63 ft.

REFERENCES

1. 46 CFR 32.55-25, Venting of cargo tanks of tank barges constructed on or after July 1, 1951 - B/ALL
2. 46 CFR 39.20-11, Vapor overpressure and vacuum protection - TB/ALL
3. 46 CFR 39.30-1, Operational Requirements - TB/ALL
4. Flow of Fluids Through Valves, Fittings, and Pipe; Crane Technical Paper No. 410
5. USCG Guidelines for Determining the Maximum Liquid Transfer Rate for a Tank Vessel Transferring a Flammable or Combustible Cargo Using a Vapor Control System
6. Conrad Dwg. 890-P3 Vapor Control Piping
7. USCG CHRIS (Chemical Hazards Response Information System) Manual.
8. 46 CFR 39.20-9, Tank Barge Liquid Overfill Protection - B/ALL
9. Cameron Hydraulic Data, 15th edition

LIST OF ATTACHMENTS

1. Flow Capacity Curves for High-Velocity P-V Valve
2. Vacuum flow diagram for High-Velocity P-V Valve

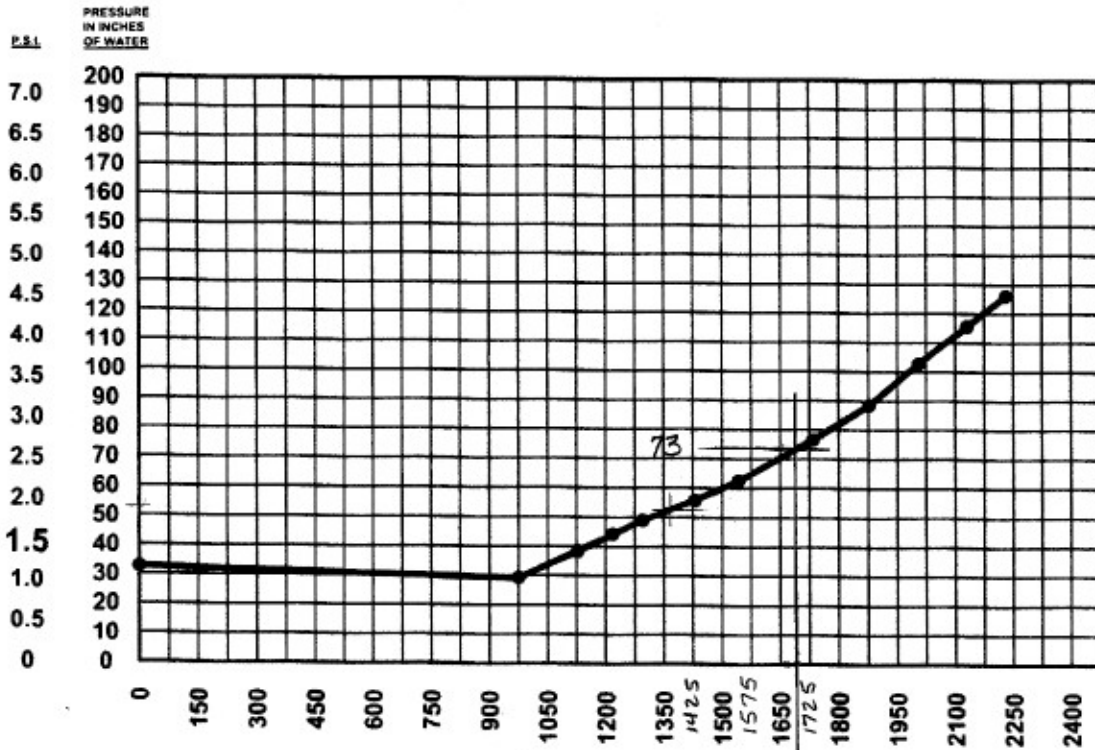

BARRELS PER HOUR	FLOW FT.³/MIN.	PRESSURE IN. OF H ₂ O
------------------	----------------	----------------------------------

10418	974	29.2
12064	1127	38.6
13017	1217	44.2
13882	1296	49.0
15296	1430	55.8
16483	1542	62.6
18547	1734	76.6
20086	1876	86.5
21435	2004	102.8
22783	2130	115.8
23882	2230	126.3

Curve for Pressure Side
 6" PV Valve - 1.5 PSI
 data based on air flow

$$18150 \text{ BBL/hr} \times \frac{42 \text{ gal}}{60 \text{ min}} \times \frac{\text{ft}^3}{7.48 \text{ gal}} = 1699 \text{ ft}^3/\text{min}$$

$$73 \text{ in H}_2\text{O} = \underline{\underline{2.64 \text{ psi}}}$$

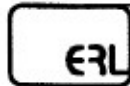

**ELECTROMECHANICAL
 RESEARCH LABORATORIES, INC.**

P.O. BOX 1088, NEW ALBANY, IN 47151

DATE
 5/5/03

DRAWN
 D. URBAN

PART NAME
 Flow Curve, 1.5 PSI, Pressure

TOLERANCE:
 0.0 = +/- 0.030
 0.00 = +/- 0.015
 0.000 = +/- 0.005

APPROVED

UNIT NAME
 Marine 6" PV (MD II)

SCALE

JOB NO.

DWG. NO.
 1250125B

ITEM NO.

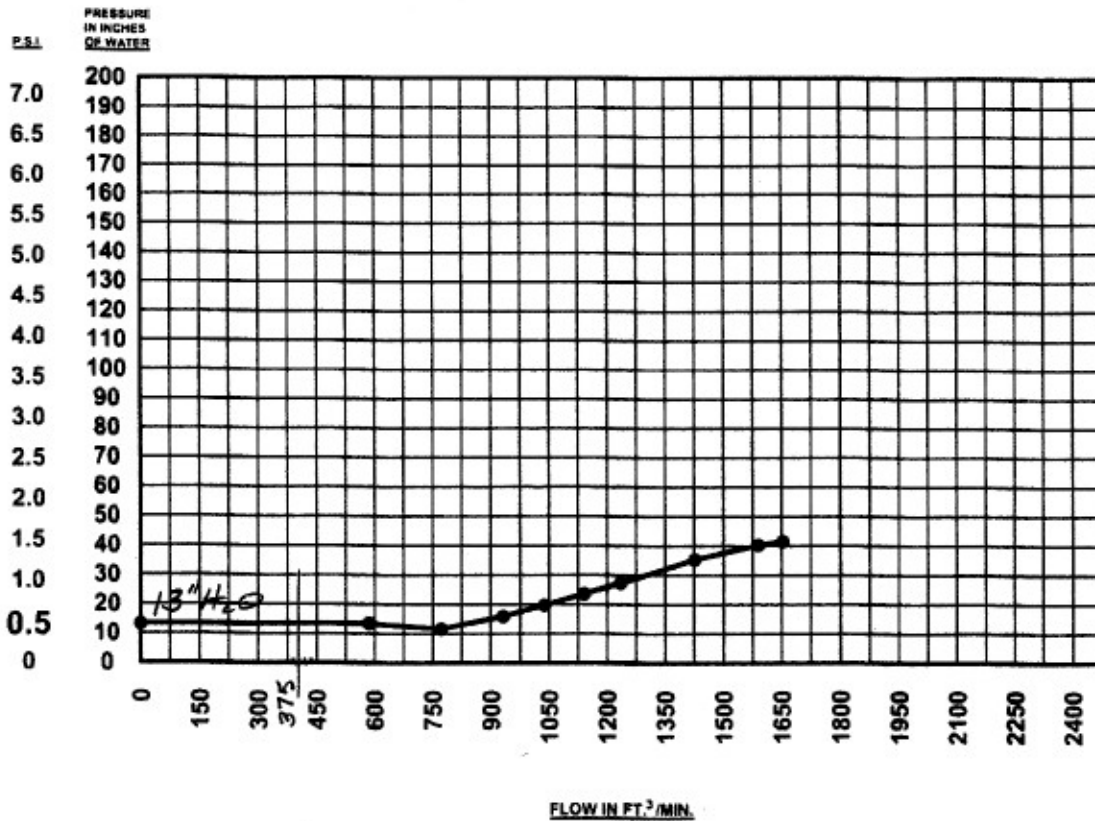

BARRELS PER HOUR	FLOW FT. ³ /MIN.	PRESSURE IN. OF H ₂ O
------------------	-----------------------------	----------------------------------

6260	585	13.6
8256	772	11.8
9958	931	16.0
11100	1038	19.9
12197	1141	23.7
13207	1235	27.5
15252	1426	35.5
17003	1590	40.4
17674	1653	41.7

Curve for Vacuum Side
6" PV Valve - 0.5 PSI
 data based on air flow

$$4300 \text{ bbl/hr} \times \frac{42 \text{ gal}}{\text{bbl}} \times \frac{\text{ft}^3}{7.48 \text{ gal}} \times \frac{\text{hr}}{60 \text{ min}} = 402 \text{ ft}^3/\text{min}$$

$$13 \text{ in H}_2\text{O} \times .03613 = 0.47 \text{ psi}$$

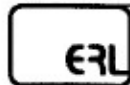

**ELECTROMECHANICAL
 RESEARCH LABORATORIES, INC.**

P.O. BOX 1026, NEW ALBANY, IN 47151

DATE 11/28/01

TOLERANCE:
 0.0 = +/- 0.030
 0.00 = +/- 0.015
 0.000 = +/- 0.005

DRAWN D. URBAN

APPROVED

SCALE

JOB NO.

PART NAME
 Flow Curve, 0.5 PSI, Vacuum

UNIT NAME
 Marine 6" PV (MD II)

DWG NO.
 332M075B

ITEM NO.

REVISIONS

REV	DESCRIPTION	DATE	BY



GUARINO & COX, LLC

19399 Helenbirg Rd. Suite 203
 Covington, La. 70433
 (985) 871-9997

THE USE OF THIS PLAN AND / OR DISCLOSURE OF ITS CONTENTS, IN ANY FASHION, IN WHOLE OR IN PART AND / OR ITS REPRODUCTION WITHOUT THE PREVIOUS WRITTEN PERMISSION OF "GUARINO & COX, LLC" IS STRICTLY PROHIBITED.

Conrad Industries, Inc

297'-6" x 54' x 12' INLAND TANK BARGE

VAPOR CONTROL SYSTEM CALCULATIONS

SCALE: NONE	DATE: 6/25/2009	DWG. NO. C-32
DRAWN BY: R. ALLUMS	CK'D BY: R. ALLUMS	
HULL NO. CONRAD C890 / ORANGE H407	JOB NO. 09-024	REV. 0

I. VAPOR CONTROL SYSTEM CALCULATIONS - SUMMARY**A. General Description of Vessel:**

Builder:	CONRAD INDUSTRIES, INC	
Builder's hull numbers:	Conrad C890 / Orange H407	
Year Built:	2009	
Official Numbers:	TBD	
Owner:	TBD	
Vessel Names:	TBD	
Vessel Dimensions:	297'-6" x 54'-0" x 12'-0"	
Service:	Inland Tank Barge (D/O) (Hull Type II, III)	
Classification:	None	
Max Design Working Pressure of Tanks:	3.00	(psig)
Max Cargo Loading Rate	5,500	(bbl/hr)
Maximum Discharge Rate	4,300	(bbl/hr)
VCS Cargoes:	See Table 1	
Maximum Vapor-Air Mixture Density:	0.35 (Pentane, all isomers)	(lbm/ft ³)
Maximum Vapor Growth Rate:	1.54 (Pentane, all isomers)	(lbm/ft ³)

B. General Description of Vapor Control System:

[Note: Also see Reference 6 for details of vapor control system.]

1. Pipe:

One (1) 8" diam longitudinal vapor header fitted with a 6" high-velocity PV Valve.
 One (1) 8" diam transverse vapor header with 8" shore connection valves.
 One (1) 8" diam branch line off longitudinal header to each cargo tank.
 (See Reference 6 for system layout)

2. High Velocity PV Valve:

Model:	ERL 6" SUPERAC PV-6	
Pressure Setting:	1.50	(psig)
Vacuum Setting:	0.5	(psig)
PV Valve Flow Capacity:	See Att. 1	(bbl/hr)

3. Spill Valve:

Model:	None installed
Pressure Setting:	N/A

4. Vapor Recovery Hose:

Diameter:	8" (assumed)
Length:	50' (assumed)

5. Cargo Tank P-V Valves:

	(One central P/V valve only, no individual tank P-V valves)	
Model:	See #2 above.	
Pressure Setting:	1.50	(psig)
Vacuum Setting:	0.5	(psig)

C. VCS Calculations:**1. Cargo Authority:**

The vapor collection system installed on this barge is designed for Grade A and lower petroleum products and chemicals. Typical cargoes to be carried by this barge are listed in Table 1. These cargoes are to be listed in the Cargo Authority Attachment (CAA) of the barge's Certificate of Inspection. Note that Table 1 is not intended to be an all-inclusive list and the CAA should therefore not be limited to these cargoes. Other cargoes with less restrictive or equal characteristics shall also be included on the CAA.

2. Determining Vapor-Air Mixture Density and Vapor Growth Rate:

Of the cargoes carried, Pentane has the highest vapor-air mixture density. Pentane also has the greatest vapor growth rate. (See Table 1)

3. The Maximum Liquid Transfer Rate as Imposed by the Capacity of the Cargo Tank Venting System: (Ref: 46 CFR 39.20-11)

Tanks #1 P/S are the farthest tanks from the High-Velocity P-V Valve in terms of total equivalent pipe length. Using factors from Reference 4 and 9, the total equivalent length of pipe is calculated for this path. This calculation is shown in Table 2.

Using Darcy's equation, and friction factors selected as appropriate for the pipe size, and the maximum liquid transfer rate, the pressure drop along the VCS piping from tank #1P to the P-V Valve is calculated using the total equivalent length of pipe from Table 2. The pressure drop calculations were done for the maximum loading rate (5,500 BBL/hr) for this barge. This maximum loading rate is based on loading one tank at a time. This calculation is shown in Table 3.

Conclusions:

Using a 5,500 bbl/hr maximum liquid transfer rate (for Pentane and lower cargos), the vapor-air mixture and air-equivalent volumetric flow rates for each cargo are shown in Table 3. The greatest pressure drop in the cargo tank venting system is 0.24 psig for Pentane cargo. At a pressure relief setting of 1.5 psig, the high-velocity P-V valve has an adequate flow capacity (see attachment 1). The greatest total back pressure imposed on the tanks by the cargo tank venting system (2.88 psig) does not exceed the design working pressure of the cargo tanks (3.00 psig). Also, the vacuum relieving capacity of the P-V Valve has been checked against the maximum discharge rate and has been found to have adequate vacuum relieving capacity (see Table 3).

4. The Maximum Liquid Transfer Rate as Imposed by the Relieving Capacity of the Cargo Tank Spill Valves:

No spill valves are installed on this barge.

5. The Maximum Liquid Transfer Rate as Imposed by the Set Point of the Overfill Alarm:

At the maximum cargo loading rate of 5,500 bbl/hr, required overfill alarm set points have been calculated such that the person in charge of the transfer operations has more than 60 seconds from the overfill alarm to stop the transfer operations before the tank overflows. (See attached overfill alarm set point calculation sheets.) The overfill alarms will need to be set at or below these calculated levels to ensure that the VCS complies with 46 CFR 39.20-9. In addition, the overfill alarms must also be set at or below a capacity of 98.5% to comply with 33CFR155.775.

6. The Maximum Liquid Transfer Rate as imposed by the pressure drop between the most remote tank and the facility vapor connection (Ref: 46 CFR 39.30-1(d)(3):

This requires the sum of the pressure drop along the longest path from the cargo tank to the vessel vapor connection and the back pressure at the facility vapor connection not to exceed 80 percent of the pressure setting of any pressure relief valve in the system. Tanks #1 P/S are the farthest from the facility vapor connection (in terms of total equivalent length of pipe). The total equivalent length from cargo tank #1P to the facility vapor connection is given in Table 4.

Using Darcy's equation, and friction factors selected as appropriate for the pipe size, and the maximum liquid transfer rate, the pressure drop along the VCS piping from tank #1P to the facility vapor connection is calculated using the total equivalent length of pipe from Table 4. These calculations are shown in Table 5.

Conclusions:

Pressure drop at the maximum liquid transfer rate of 5,500 bbl/hr (for Pentane and lower cargoes) along this path for each cargo is given in Table 5. The highest pressure drop (for Pentane) does not exceed 80 percent of the P-V valve pressure setting. If the pressure drop between the facility vapor connection and the shore facility's pressure sensor is known, it should be added to the pressure drop along this path to ensure that the total pressure drop does not exceed 80 percent of the P-V valve pressure setting.

7. Graph as Required by 46 CFR 39.30-1(b)(3):

See attached.

Table 1 Determination of Vapor-Air Mixture Density & Vapor Growth Rate

	CHRIS Code	Name	VCS Category	Liquid S.G.	*Vapor Press. @ 115 F (psia)	Vapor S.G.	Vapor-air Mixture Weight Density (lb/ft ³)	Vapor Growth Rate	Max. Loading Rate	Vapor Volumetric Flow Rate (bbl/hr)	Air Equivalent Volumetric Flow Rate (bbl/hr)	Pressure Drop to PV Valve in VCS (See Table 3) (psig)	Pressure Drop to Facility Connection in VCS (See Table 5) (psig)
1	ACN	Acrylonitrile	4	0.81	5.00	1.80	0.095	1.10	5,500	6050	6756	0.033	0.066
2	ACT	Acetone	1	0.79	10.00	2.00	0.123	1.20	5,500	6600	8393	0.052	0.102
3	ACP	Acetophenone	1	1.03	0.60	4.14	0.085	1.01	5,500	5566	5881	0.025	0.050
4	AND	Adiponitrile	1	0.95	0.01	3.73	0.076	1.00	5,500	5501	5506	0.022	0.044
5	AEC	Amyl acetate (all isomers)	1	0.88	0.33	0.10	0.075	1.01	5,500	5536	5485	0.022	0.044
6	AAI	Amyl Alcohol (iso-, n-, sec-, primary)	1	0.82	0.30	3.04	0.079	1.01	5,500	5533	5637	0.023	0.046
7	ATN	Acetonitrile	3	0.78	0.03	1.41	0.076	1.00	5,500	5503	5505	0.022	0.044
8	BAL	Benzyl Alcohol	1	1.05	0.10	3.73	0.077	1.00	5,500	5511	5557	0.023	0.045
9	BNZ	Benzene	1	0.88	4.50	2.80	0.114	1.25	5,500	6875	8420	0.052	0.103
10	BTX	Benzene, Toluene, Xylene mixtures (10% Benzene or more)	1	0.84	7.30	2.80	0.138	1.25	5,500	6875	9252	0.063	0.124
11	BAR	Butyl Acrylate (iso-, n-)	2	0.90	0.60	4.42	0.086	1.01	5,500	5566	5908	0.026	0.051
12	BAX	Butyl Acetate (all isomers)	1	0.87	0.60	4.00	0.085	1.01	5,500	5566	5867	0.025	0.050
13	IAL	Butyl Alcohol (iso-)	1	0.81	0.90	2.60	0.083	1.02	5,500	5599	5843	0.025	0.050
14	BAN	Butyl Alcohol (n-)	1	0.81	0.50	0.10	0.074	1.01	5,500	5555	5477	0.022	0.044
15	BAS	Butyl Alcohol (sec-)	1	0.81	1.30	2.60	0.086	1.03	5,500	5643	5994	0.026	0.052
16	BAT	Butyl Alcohol (tert-)	1	0.78	2.80	2.60	0.097	1.06	5,500	5808	6562	0.032	0.063
17	BPH	Butyl Benzyl Phthalate	1	1.12	0.01	10.80	0.077	1.00	5,500	5501	5518	0.022	0.044
18	BAD	iso-Butyraldehyde	1	0.80	7.80	2.50	0.131	1.16	5,500	6358	8344	0.051	0.101
19	BTR	n-Butyraldehyde	1	0.80	7.80	2.50	0.131	1.16	5,500	6358	8344	0.051	0.101
20	BUE	Butyl Toluene	1	0.85	0.10	5.11	0.078	1.00	5,500	5511	5580	0.023	0.045
21	CLS	Caprolactam Solutions	1	1.02	0.05	3.90	0.077	1.00	5,500	5506	5530	0.022	0.044
22	CCH	Cyclohexanone	1	0.95	0.20	3.40	0.078	1.00	5,500	5522	5603	0.023	0.046
23	CHA	Cyclohexylamine	1	0.87	0.62	3.42	0.083	1.01	5,500	5568	5820	0.025	0.049
24	CHX	Cyclohexane	1	0.78	4.50	2.90	0.116	1.09	5,500	5995	7410	0.040	0.080
25	CHN	Cyclohexanol	1	0.95	0.15	3.45	0.078	1.00	5,500	5517	5579	0.023	0.045
26	CPD	1,3-Cyclopentadiene dimer (molten)	2	0.69	0.25	4.55	0.080	1.01	5,500	5528	5677	0.024	0.047
27	CMP	p-Cymene	1	0.86	0.11	4.62	0.078	1.00	5,500	5512	5579	0.023	0.045
28	CRB	Chlorobenzene	1	1.11	0.80	3.88	0.087	1.02	5,500	5588	5972	0.026	0.052
29	CRS	Cresols	1	1.05	0.08	3.72	0.077	1.00	5,500	5509	5546	0.022	0.045
30	CUM	Cumene	1	0.86	0.60	4.20	0.085	1.01	5,500	5566	5887	0.025	0.050
31	IDA	Decaldehyde (iso-)	1	0.83	0.01	5.00	0.076	1.00	5,500	5501	5508	0.022	0.044
32	DAL	Decaldehyde (n-)	1	0.83	0.00	5.01	0.076	1.00	5,500	5500	5500	0.022	0.044
33	DCE	Decene	1	0.74	0.12	4.80	0.078	1.00	5,500	5513	5590	0.023	0.045
34	DAX	Decyl Alcohol (all isomers) (Decanol)	1	0.83	0.01	5.30	0.076	1.00	5,500	5501	5508	0.022	0.044
35	DBZ	Decylbenzene (n-)	1	0.86	0.01	7.52	0.076	1.00	5,500	5501	5512	0.022	0.044
36	DAA	Diacetone Alcohol	1	0.97	0.10	4.00	0.078	1.00	5,500	5511	5562	0.023	0.045
37	DCH	1,1-Dichloroethane	1	1.18	9.90	3.41	0.188	1.20	5,500	6589	10361	0.079	0.156
38	DPA	Dibutyl Phthalate (ortho-)	1	1.05	0.00	9.59	0.076	1.00	5,500	5500	5500	0.022	0.044
39	DEB	Diethylbenzene	1	0.87	0.08	4.62	0.078	1.00	5,500	5509	5558	0.023	0.045
40	DEG	Diethylene Glycol	1	1.12	0.01	3.66	0.076	1.00	5,500	5501	5506	0.022	0.044
41	DEN	Diethylamine	3	0.71	1.00	2.50	0.083	1.02	5,500	5610	5864	0.025	0.050
42	DBL	Diisobutylene	1	0.72	2.00	3.86	0.103	1.04	5,500	5720	6654	0.032	0.064
43	DIK	Diisobutyl Ketone	1	0.81	0.16	4.90	0.079	1.00	5,500	5518	5623	0.023	0.046
44	DIP	Diisopropanolamine	1	0.98	0.01	4.59	0.076	1.00	5,500	5501	5507	0.022	0.044
45	DIX	Diisopropylbenzene (all isomers)	1	0.86	0.03	5.60	0.077	1.00	5,500	5503	5527	0.022	0.044
46	DTL	Dimethyl Phthalate	1	1.19	0.00	6.69	0.076	1.00	5,500	5500	5500	0.022	0.044
47	DOP	Diocyl Phthalate	1	0.98	0.00	13.47	0.076	1.00	5,500	5500	5500	0.022	0.044
48	DPN	Dipentene	1	0.84	0.10	4.90	0.078	1.00	5,500	5511	5577	0.023	0.045
49	DIL	Diphenyl	1	0.99	0.01	5.31	0.076	1.00	5,500	5501	5508	0.022	0.044
50	DDO	Diphenyl, Diphenyl Ether Mixtures	1	1.07	0.01	5.86	0.076	1.00	5,500	5501	5509	0.022	0.044
51	DMF	Dimethylformamide	1	0.95	0.30	2.51	0.078	1.01	5,500	5533	5610	0.023	0.046
52	DPE	Diphenyl Ether	1	1.07	0.01	5.87	0.076	1.00	5,500	5501	5509	0.022	0.044
53	DPG	Dipropylene Glycol	1	1.03	0.07	4.63	0.077	1.00	5,500	5508	5551	0.023	0.045
54	DPX	1,1-, 1,2-, 1,3-Dichloropropane	3	1.16	6.30	3.90	0.162	1.13	5,500	6193	9034	0.060	0.119
55	DFE	Distillates Flashed Feed Stocks	1	0.75	2.30	3.40	0.102	1.05	5,500	5753	6661	0.032	0.064
56	DSR	Distillates Straight Run	1	0.73	2.30	3.40	0.102	1.05	5,500	5753	6661	0.032	0.064
57	DOZ	Dodecene (all isomers)	1	0.76	0.02	5.81	0.077	1.00	5,500	5502	5519	0.022	0.044
58	DDB	Dodecylbenzene	1	0.86	4.70	8.40	0.240	1.25	5,500	6875	12196	0.109	0.216
59	EAC	Ethyl Acrylate	2	0.93	2.00	3.50	0.100	1.04	5,500	5720	6543	0.031	0.062
60	EAI	2-Ethylhexyl acrylate	2	0.89	0.02	6.35	0.077	1.00	5,500	5502	5520	0.022	0.044
61	EEA	2-Ethoxyethyl acetate	1	0.97	0.02	4.70	0.077	1.00	5,500	5503	5517	0.022	0.044
62	ETG	Ethoxy Triglycol (crude)	1	1.02	0.00	6.14	0.076	1.00	5,500	5500	5500	0.022	0.044
63	ETA	Ethyl Acetate	1	0.90	4.50	3.04	0.119	1.09	5,500	5995	7504	0.041	0.082
64	EAA	Ethyl Acetoacetate	1	1.03	0.20	4.48	0.079	1.00	5,500	5522	5639	0.023	0.046
65	EAL	Ethyl Alcohol (Ethanol)	1	0.79	3.50	1.60	0.086	1.07	5,500	5885	6255	0.029	0.057
66	ETB	Ethyl Benzene	1	0.87	0.60	3.56	0.083	1.01	5,500	5566	5824	0.025	0.049
67	EBT	Ethyl Butanol	1	0.83	0.12	3.52	0.078	1.00	5,500	5513	5564	0.023	0.045
68	EBE	Ethyl tert-butyl ether	1	0.74	0.19	3.50	0.078	1.00	5,500	5521	5602	0.023	0.046

	CHRIS Code	Name	VCS Category	Liquid S.G.	*Vapor Press. @ 115 F (psia)	Vapor S.G.	Vapor-air Mixture Weight Density (lb/ft ³)	Vapor Growth Rate	Max. Loading Rate	Vapor Volumetric Flow Rate (bbl/hr)	Air Equivalent Volumetric Flow Rate (bbl/hr)	Pressure Drop to PV Valve in VCS (See Table 3) (psig)	Pressure Drop to Facility Connection in VCS (See Table 5) (psig)
69	EBR	Ethyl butyrate	1	0.88	1.00	4.00	0.090	1.02	5,500	5610	6107	0.027	0.054
70	ECY	Ethyl Cyclohexane	1	0.79	0.50	3.87	0.083	1.01	5,500	5555	5796	0.025	0.049
71	EDC	Ethylene dichloride	1	1.26	4.00	3.42	0.122	1.08	5,500	5940	7508	0.041	0.082
72	EGL	Ethylene Glycol	1	1.19	0.01	2.21	0.076	1.00	5,500	5501	5503	0.022	0.044
73	EMA	Ethylene Glycol Butyl Ether Acetate	1	0.94	0.05	5.52	0.077	1.00	5,500	5506	5544	0.022	0.045
74	EGY	Ethylene Glycol Diacetate	1	1.10	0.01	5.03	0.076	1.00	5,500	5501	5508	0.022	0.044
75	EPE	Ethylene Glycol Phenyl Ether	1	1.10	0.01	4.80	0.076	1.00	5,500	5501	5508	0.022	0.044
76	EPP	Ethyl-3-ethoxypropionate	1	0.95	0.01	5.00	0.076	1.00	5,500	5501	5510	0.022	0.044
77	EHX	2-Ethylhexanol	1	0.84	0.02	4.50	0.076	1.00	5,500	5502	5514	0.022	0.044
78	EPR	Ethyl Propionate	1	0.89	3.50	1.60	0.086	1.07	5,500	5885	6255	0.029	0.057
79	ETE	Ethyl Toluene	1	0.88	0.28	4.15	0.080	1.01	5,500	5531	5679	0.024	0.047
80	FAM	Formamide	1	1.13	0.10	1.55	0.076	1.00	5,500	5511	5520	0.022	0.044
81	FMS	Formaldehyde Solution	1	1.13	0.15	1.03	0.076	1.00	5,500	5517	5517	0.022	0.044
82	FAL	Furfuryl Alcohol	1	1.13	0.05	3.40	0.077	1.00	5,500	5506	5526	0.022	0.044
83	FFA	Furfural	1	1.20	0.15	3.31	0.078	1.00	5,500	5517	5575	0.023	0.045
84	GAK	Gasoline Blending Stocks: Alkylates	1	0.75	12.50	3.40	0.217	1.25	5,500	6875	11610	0.099	0.196
85	GRF	Gasoline Blending Stocks: Reformates	1	0.80	12.50	3.40	0.217	1.25	5,500	6875	11610	0.099	0.196
86	GAT	Gasolines: Automotive	1	0.74	12.50	3.40	0.217	1.25	5,500	6875	11610	0.099	0.196
87	GAV	Gasolines: Aviation	1	0.71	12.50	3.40	0.217	1.25	5,500	6875	11610	0.099	0.196
88	GCS	Gasolines: Casinghead	1	0.67	12.50	3.40	0.217	1.25	5,500	6875	11610	0.099	0.196
89	GPL	Gasolines: Polymer	1	0.75	12.50	3.40	0.217	1.25	5,500	6875	11610	0.099	0.196
90	GSR	Gasolines: StraightRun	1	0.75	12.50	3.40	0.217	1.25	5,500	6875	11610	0.099	0.196
91	GCR	Glycerine	1	1.26	0.00	3.17	0.076	1.00	5,500	5500	5500	0.022	0.044
92	HMX	Heptane (all isomers)	1	0.68	2.50	3.45	0.105	1.05	5,500	5775	6779	0.034	0.067
93	HEP	Heptonic Acid	1	0.92	0.01	4.49	0.076	1.00	5,500	5501	5507	0.022	0.044
94	HTX	Heptanol (all isomers)	1	0.82	0.04	4.00	0.077	1.00	5,500	5504	5525	0.022	0.044
95	HPX	Heptene (all isomers)	2	0.70	2.90	3.40	0.109	1.06	5,500	5819	6958	0.035	0.070
96	HXS	Hexane (all isomers)	1	0.66	7.00	3.00	0.142	1.14	5,500	6270	8561	0.054	0.106
97	HXO	Hexanoic Acid	1	0.93	0.01	4.00	0.076	1.00	5,500	5501	5506	0.022	0.044
98	HXN	Hexanol	1	0.82	1.00	3.52	0.088	1.02	5,500	5610	6031	0.027	0.053
99	HEX	Hexene (all isomers)	2	0.67	8.00	2.90	0.148	1.16	5,500	6380	8882	0.058	0.115
100	HXG	Hexylene Glycol	1	0.92	0.01	1.10	0.076	1.00	5,500	5501	5501	0.022	0.044
101	IPH	Isophorone	1	0.93	0.01	4.75	0.076	1.00	5,500	5501	5507	0.022	0.044
102	JPF	Jet Fuels: JP-4	1	0.81	3.40	4.00	0.124	1.07	5,500	5874	7499	0.041	0.082
103	JPV	Jet Fuels JP-5 (Kerosene. heavy)	1	0.82	0.10	4.00	0.078	1.00	5,500	5511	5562	0.023	0.045
104	KRS	Kerosene	1	0.81	0.15	4.50	0.079	1.00	5,500	5517	5605	0.023	0.046
105	MTT	Methyl Acetate	1	0.92	6.10	2.60	0.122	1.12	5,500	6171	7812	0.045	0.089
106	MAL	Methyl Alcohol (Methanol)	1	0.79	6.63	1.10	0.079	1.13	5,500	6229	6355	0.030	0.059
107	MAC	Methylamyl Acetate	1	0.86	0.33	4.97	0.082	1.01	5,500	5536	5756	0.024	0.048
108	MAA	Methylamyl Alcohol	1	0.81	0.43	3.52	0.081	1.01	5,500	5547	5730	0.024	0.048
109	MAK	Methylamyl Keytone	1	0.82	0.05	1.00	0.076	1.00	5,500	5506	5506	0.022	0.044
110	MAM	Methyl Acrylate	2	0.95	4.10	3.00	0.115	1.08	5,500	5951	7303	0.039	0.078
111	MBE	Methyl Tert-Butyl Ether (MTBE)	1	0.74	0.04	3.10	0.077	1.00	5,500	5504	5519	0.022	0.044
112	MBK	Methyl Butyl Ketone	1	0.81	0.97	3.50	0.088	1.02	5,500	5607	6012	0.026	0.053
113	MBU	Methyl Butyrate	1	0.90	1.26	3.53	0.091	1.03	5,500	5639	6168	0.028	0.055
114	MEK	Methyl Ethyl Ketone	1	0.80	4.50	2.50	0.108	1.09	5,500	5995	7135	0.037	0.074
115	MHK	Methyl Heptyl Ketone	1	0.83	0.06	4.90	0.077	1.00	5,500	5507	5546	0.023	0.045
116	MIK	Methyl Isobutyl Ketone	1	0.80	1.15	3.45	0.089	1.02	5,500	5627	6096	0.027	0.054
117	MMM	Methyl methacrylate	2	0.94	2.02	3.45	0.099	1.04	5,500	5722	6538	0.031	0.062
118	MNA	Methyl Naphthalene	1	1.02	0.01	4.91	0.076	1.00	5,500	5501	5508	0.022	0.044
119	MNS	Mineral Spirits	1	0.75	0.20	4.30	0.079	1.00	5,500	5522	5633	0.023	0.046
120	MPL	Morpholine	1	1.00	0.80	3.00	0.084	1.02	5,500	5588	5857	0.025	0.050
121	MRE	Myrcene	1	0.80	0.17	4.70	0.079	1.00	5,500	5519	5625	0.023	0.046
122	PTN	Naphtha: Petroleum	1	0.74	0.19	3.50	0.078	1.00	5,500	5521	5600	0.023	0.046
123	NSV	Naphtha: Solvent	1	0.87	0.20	3.50	0.078	1.00	5,500	5522	5607	0.023	0.046
124	NSS	Naphtha: Stoddard Solvent	1	0.78	0.20	4.30	0.079	1.00	5,500	5522	5633	0.023	0.046
125	NVM	Naphtha: VM&P	1	0.77	0.19	4.30	0.079	1.00	5,500	5521	5627	0.023	0.046
126	NAX	Nonane (all isomers)	1	0.72	0.27	4.40	0.080	1.01	5,500	5530	5684	0.024	0.047
127	NON	Nonene (all isomers)	2	0.73	0.35	4.30	0.082	1.01	5,500	5539	5733	0.024	0.048
128	NNS	Nonyl Alcohol (all isomers)	1	0.94	0.10	5.00	0.078	1.00	5,500	5511	5579	0.023	0.045
129	NNP	Nonyl Phenol	1	0.95	0.01	7.60	0.076	1.00	5,500	5501	5512	0.022	0.044
130	NPM	1-, 2-Nitropropane	1	0.99	1.05	3.06	0.086	1.02	5,500	5616	5979	0.026	0.052
131	OAX	Octane (all isomers)	1	0.70	0.79	3.90	0.087	1.02	5,500	5587	5969	0.026	0.052
132	OCX	Octanol (all isomers)	1	0.83	0.01	4.48	0.076	1.00	5,500	5501	5507	0.022	0.044
133	OTX	Octene (all isomers)	2	0.72	0.90	3.90	0.088	1.02	5,500	5599	6033	0.027	0.053
134	OTW	Oil, fuel: No. 2	1	0.88	0.56	8.00	0.095	1.01	5,500	5562	6198	0.028	0.056
135	OTD	Oil, fuel: No. 2-D	1	0.90	0.69	3.40	0.084	1.01	5,500	5576	5853	0.025	0.050
136	OFR	Oil, fuel: No. 4	1	0.90	0.15	3.40	0.078	1.00	5,500	5517	5577	0.023	0.045
137	OFV	Oil, fuel: No. 5	1	0.94	0.15	3.40	0.078	1.00	5,500	5517	5577	0.023	0.045
138	OSX	Oil, fuel: No. 6	1	0.95	0.15	3.40	0.078	1.00	5,500	5517	5577	0.023	0.045
139	OIL	Oil, misc: Crude	1	0.95	0.15	3.40	0.078	1.25	5,500	6875	6951	0.035	0.070
140	ODS	Oil, Misc: Diesel	1	0.90	0.69	3.40	0.084	1.01	5,500	5576	5854	0.025	0.050
141	OLB	Oil, Misc: Lubricating	1	0.90	0.15	1.00	0.076	1.00	5,500	5517	5517	0.022	0.044

Vapor Recovery Calculations

	CHRIS Code	Name	VCS Category	Liquid S.G.	*Vapor Press. @ 115 F (psia)	Vapor S.G.	Vapor-air Mixture Weight Density (lb/ft ³)	Vapor Growth Rate	Max. Loading Rate	Vapor Volumetric Flow Rate (bbl/hr)	Air Equivalent Volumetric Flow Rate (bbl/hr)	Pressure Drop to PV Valve in VCS (See Table 3) (psig)	Pressure Drop to Facility Connection in VCS (See Table 5) (psig)
142	ORL	Oil, Misc: Residual	1	1.02	0.15	1.00	0.076	1.00	5,500	5517	5517	0.022	0.044
143	OTB	Oil, Misc: Turbine	1	0.87	0.30	5.40	0.082	1.01	5,500	5533	5754	0.024	0.048
144	PTY	Pentane (all isomers)	5	0.63	27.00	2.50	0.350	1.54	5,500	8470	18150	0.241	0.479
145	PTE	Pentene (all isomers)	5	0.64	24.95	2.40	0.310	1.50	5,500	8245	16640	0.203	0.402
146	PIN	Pinene	1	0.86	0.38	4.70	0.083	1.01	5,500	5542	5777	0.024	0.048
147	PLB	Polybutene	1	0.91	0.01	1.00	0.076	1.00	5,500	5501	5501	0.022	0.044
148	PGC	Polypropylene Glycol	1	1.01	0.10	1.00	0.076	1.00	5,500	5511	5511	0.022	0.044
149	IAC	Propyl Acetate (iso-)	1	0.89	1.80	3.52	0.097	1.04	5,500	5698	6447	0.030	0.060
150	PAT	Propyl Acetate (n-)	1	0.00	1.85	3.52	0.098	1.04	5,500	5704	6472	0.031	0.061
151	IPA	Propyl Alcohol (iso-)	1	0.79	3.00	2.07	0.091	1.06	5,500	5830	6382	0.030	0.059
152	PAL	Propyl Alcohol (n-)	1	0.80	1.20	2.07	0.082	1.02	5,500	5632	5851	0.025	0.050
153	PBY	Propylbenzene (all isomers)	1	0.86	0.20	4.14	0.079	1.00	5,500	5522	5628	0.023	0.046
154	IPX	iso-Propylcyclohexane	1	0.80	0.01	4.35	0.076	1.00	5,500	5501	5507	0.022	0.044
155	PPG	Propylene Glycol	1	1.04	0.01	2.62	0.076	1.00	5,500	5501	5504	0.022	0.044
156	PGN	Propylene Glycol Methyl Ether Acetate	1	0.92	0.70	3.11	0.083	1.01	5,500	5577	5826	0.025	0.049
157	PTT	Propylene Tetramer	1	0.29	0.02	1.00	0.076	1.00	5,500	5502	5502	0.022	0.044
158	SFL	Sulfolane	1	1.26	0.01	4.14	0.076	1.00	5,500	5501	5506	0.022	0.044
159	STY	Styrene	2	0.92	0.40	3.60	0.081	1.01	5,500	5544	5719	0.024	0.048
160	TTG	Tetraethylene Glycol	1	1.20	0.01	6.70	0.076	1.00	5,500	5501	5511	0.022	0.044
161	THN	Tetrahydronaphthalene	1	0.97	0.04	4.56	0.077	1.00	5,500	5504	5529	0.022	0.044
162	TOL	Toluene	1	0.87	1.50	3.14	0.091	1.03	5,500	5665	6201	0.028	0.056
163	TCN	1,2,3-Trichloropropane	3	1.39	0.15	5.60	0.079	1.00	5,500	5517	5633	0.023	0.046
164	TCP	Tricresyl Phosphate (less than 1% of ortho)	1	1.16	0.01	12.69	0.077	1.00	5,500	5501	5521	0.022	0.044
165	TEB	Triethylbenzene	1	0.86	0.02	5.60	0.077	1.00	5,500	5502	5518	0.022	0.044
166	TEN	Triethylamine	3	0.73	2.50	3.49	0.105	1.05	5,500	5775	6795	0.034	0.067
167	TEG	Triethylene Glycol	1	1.12	0.01	5.17	0.076	1.00	5,500	5501	5508	0.022	0.044
168	TPS	Triethyl Phosphate	1	1.07	0.03	6.28	0.077	1.00	5,500	5503	5530	0.022	0.044
169	TRE	Trimethylbenzene (all isomers)	1	0.89	0.14	4.20	0.078	1.00	5,500	5515	5588	0.023	0.045
170	TRP	Trixylenyl Phosphate	1	1.16	0.00	14.20	0.076	1.00	5,500	5500	5500	0.022	0.044
171	THF	Tetrahydrofuran	1	0.89	8.50	1.35	0.090	1.17	5,500	6435	7001	0.036	0.071
172	UDC	Undecene	1	0.75	0.05	5.32	0.077	1.00	5,500	5506	5542	0.022	0.045
173	UND	Undecyl Alcohol	1	0.84	0.01	5.94	0.076	1.00	5,500	5501	5509	0.022	0.044
174	VAM	Vinyl Acetate	2	0.94	5.80	2.97	0.130	1.12	5,500	6138	8015	0.047	0.093
175	XLX	Xylenes (ortho-, meta-, para-)	1	0.89	0.51	3.68	0.083	1.01	5,500	5556	5786	0.024	0.049

max = 0.350 1.54 max = 0.241 0.479

Notes: 1. The above data is sourced from the USCG CHRIS Manual (Ref. 7) & from various manufacturer's MSDS's.

Table 2 Calculation of Maximum Liquid Transfer Rate as Imposed by the Capacity of the Cargo Tank Venting System

Note: Darcy's equation will be used to estimate the pressure drop of the vapor-air mixture through the vent piping from the farthest tank in terms of equivalent pipe length (#1P) to the P-V valve. Equivalent length for this path is calculated using Crane's Technical Paper 410 (Ref 4) and Cameron Hydraulic Data handbook (Ref 9).

Calculate equivalent lengths of pipe:

- a. Pipe run #1
 Description: 8" Branch (Exp trunk to vapor stack)
 Pipe size, nominal: 8" sch. 40 pipe
 Pipe ID (inches): 7.98

Item	Description	Size (in)	Qty	Unit Equivalent Length (ft)	Total Equivalent Length (ft)
1	Entrance	8	1	23.3	23.3
2	Straight Pipe	8	1	54.0	54.0
3	Tee, branch	8	2	39.9	79.8
4	Tee, flow	8	1	13.3	13.3
5					
6					
	Sum (pipe run #1)				170.4

- b. Pipe run #2
 Description: 6" branch at P-V valve
 Pipe size, nominal: 6" sch. 40 pipe
 Pipe ID (inches): 6.07

Item	Description	Size (in)	Qty	Unit Equivalent Length (ft)	Total Equivalent Length (ft)
1	Straight Pipe	6	1	3.0	3.0
2	Reducer (8x6)	6	1	6.4	6.4
	Sum (pipe run #2)				9.4

Table 3 Calculation of Maximum Liquid Transfer Rate as Imposed by the Capacity of the Cargo Tank Venting System (Continued)

A. Calculate pressure drop using Darcy's equation:

CHRIS Code	Name	Vapor-air Mixture Weight Density (from Table 1) (lb/ft ³)	Liquid Transfer Rate (filling) (bbl/hr)	Vapor Growth Rate	Pipe run #1			Pipe run #2			Pressure Drop (Total) (psig)	Air Equiv. Volumetric Flow Rate (bbl/hr)
					Vapor Volumetric Flow Rate (bbl/hr)	Mean Velocity (ft/s)	Pressure Drop (pipe run #1) (psig)	Vapor Volumetric Flow Rate (bbl/hr)	Mean Velocity (ft/s)	Pressure Drop (pipe run #2) (psig)		
					Description: 8" Branch (Exp trunk to vapor stack) Pipe ID: 7.98 (in) Equiv. Pipe Length (table 2a): 170.4 (feet) Darcy friction factor: 0.014			Description: 6" branch at P-V valve Pipe ID: 6.07 (in) Equiv. Pipe Length (table 2b): 9.4 (feet) Darcy friction factor: 0.015				
1	ACN	0.095	5,500	1.100	6050	27.16	0.027	6050	46.95	0.006	0.033	6756
2	ACT	0.123	5,500	1.200	6600	29.63	0.042	6600	51.22	0.010	0.052	8393
3	ACP	0.085	5,500	1.012	5566	24.99	0.021	5566	43.19	0.005	0.025	5881
4	AND	0.076	5,500	1.000	5501	24.70	0.018	5501	42.69	0.004	0.022	5506
5	AEC	0.075	5,500	1.007	5536	24.86	0.018	5536	42.96	0.004	0.022	5485
6	AAI	0.079	5,500	1.006	5533	24.84	0.019	5533	42.94	0.004	0.023	5637
7	ATN	0.076	5,500	1.001	5503	24.71	0.018	5503	42.71	0.004	0.022	5505
8	BAL	0.077	5,500	1.002	5511	24.74	0.018	5511	42.77	0.004	0.023	5557
9	BNZ	0.114	5,500	1.250	6875	30.87	0.042	6875	53.35	0.010	0.052	8420
10	BTX	0.138	5,500	1.250	6875	30.87	0.051	6875	53.35	0.012	0.063	9252
11	BAR	0.086	5,500	1.012	5566	24.99	0.021	5566	43.19	0.005	0.026	5908
12	BAX	0.085	5,500	1.012	5566	24.99	0.020	5566	43.19	0.005	0.025	5867
13	IAL	0.083	5,500	1.018	5599	25.14	0.020	5599	43.45	0.005	0.025	5843
14	BAN	0.074	5,500	1.010	5555	24.94	0.018	5555	43.11	0.004	0.022	5477
15	BAS	0.086	5,500	1.026	5643	25.34	0.021	5643	43.79	0.005	0.026	5994
16	BAT	0.097	5,500	1.056	5808	26.08	0.026	5808	45.07	0.006	0.032	6562
17	BPH	0.077	5,500	1.000	5501	24.70	0.018	5501	42.69	0.004	0.022	5518
18	BAD	0.131	5,500	1.156	6358	28.55	0.041	6358	49.34	0.010	0.051	8344
19	BTR	0.131	5,500	1.156	6358	28.55	0.041	6358	49.34	0.010	0.051	8344
20	BUE	0.078	5,500	1.002	5511	24.74	0.018	5511	42.77	0.004	0.023	5580
21	CLS	0.077	5,500	1.001	5506	24.72	0.018	5506	42.72	0.004	0.022	5530
22	CCH	0.078	5,500	1.004	5522	24.79	0.019	5522	42.85	0.004	0.023	5603
23	CHA	0.083	5,500	1.012	5568	25.00	0.020	5568	43.21	0.005	0.025	5820
24	CHX	0.116	5,500	1.090	5995	26.92	0.033	5995	46.52	0.008	0.040	7410
25	CHN	0.078	5,500	1.003	5517	24.77	0.018	5517	42.81	0.004	0.023	5579
26	CPD	0.080	5,500	1.005	5528	24.82	0.019	5528	42.90	0.004	0.024	5677
27	CMP	0.078	5,500	1.002	5512	24.75	0.018	5512	42.78	0.004	0.023	5579
28	CRB	0.087	5,500	1.016	5588	25.09	0.021	5588	43.36	0.005	0.026	5972
29	CRS	0.077	5,500	1.002	5509	24.73	0.018	5509	42.75	0.004	0.022	5546
30	CUM	0.085	5,500	1.012	5566	24.99	0.021	5566	43.19	0.005	0.025	5887
31	IDA	0.076	5,500	1.000	5501	24.70	0.018	5501	42.69	0.004	0.022	5508
32	DAL	0.076	5,500	1.000	5500	24.70	0.018	5500	42.68	0.004	0.022	5500
33	DCE	0.078	5,500	1.002	5513	24.75	0.019	5513	42.78	0.004	0.023	5590
34	DAX	0.076	5,500	1.000	5501	24.70	0.018	5501	42.69	0.004	0.022	5508
35	DBZ	0.076	5,500	1.000	5501	24.70	0.018	5501	42.69	0.004	0.022	5512
36	DA	0.078	5,500	1.002	5511	24.74	0.018	5511	42.77	0.004	0.023	5562
37	DCH	0.188	5,500	1.198	6589	29.59	0.064	6589	51.13	0.015	0.079	10361
38	DPA	0.076	5,500	1.000	5500	24.70	0.018	5500	42.68	0.004	0.022	5500
39	DEB	0.078	5,500	1.002	5509	24.73	0.018	5509	42.75	0.004	0.023	5558
40	DEG	0.076	5,500	1.000	5501	24.70	0.018	5501	42.69	0.004	0.022	5506
41	DEN	0.083	5,500	1.020	5610	25.19	0.020	5610	43.54	0.005	0.025	5864
42	DBL	0.103	5,500	1.040	5720	25.68	0.026	5720	44.39	0.006	0.032	6654
43	DIK	0.079	5,500	1.003	5518	24.77	0.019	5518	42.82	0.004	0.023	5623
44	DIP	0.076	5,500	1.000	5501	24.70	0.018	5501	42.69	0.004	0.022	5507
45	DIX	0.077	5,500	1.001	5503	24.71	0.018	5503	42.71	0.004	0.022	5527
46	DTL	0.076	5,500	1.000	5500	24.70	0.018	5500	42.68	0.004	0.022	5500
47	DOP	0.076	5,500	1.000	5500	24.70	0.018	5500	42.68	0.004	0.022	5500
48	DPN	0.078	5,500	1.002	5511	24.74	0.018	5511	42.77	0.004	0.023	5577
49	DIL	0.076	5,500	1.000	5501	24.70	0.018	5501	42.69	0.004	0.022	5508
50	DDO	0.076	5,500	1.000	5501	24.70	0.018	5501	42.69	0.004	0.022	5509
51	DMF	0.078	5,500	1.006	5533	24.84	0.019	5533	42.94	0.004	0.023	5610
52	DPE	0.076	5,500	1.000	5501	24.70	0.018	5501	42.69	0.004	0.022	5509
53	DPG	0.077	5,500	1.001	5508	24.73	0.018	5508	42.74	0.004	0.023	5551
54	DPX	0.162	5,500	1.126	6193	27.81	0.048	6193	48.06	0.011	0.060	9034
55	DDF	0.102	5,500	1.046	5753	25.83	0.026	5753	44.65	0.006	0.032	6661
56	DSR	0.102	5,500	1.046	5753	25.83	0.026	5753	44.65	0.006	0.032	6661
57	DOZ	0.077	5,500	1.000	5502	24.71	0.018	5502	42.70	0.004	0.022	5519
58	DDB	0.240	5,500	1.250	6875	30.87	0.088	6875	53.35	0.021	0.109	12196
59	EAC	0.100	5,500	1.040	5720	25.68	0.025	5720	44.39	0.006	0.031	6543
60	EAI	0.077	5,500	1.000	5502	24.71	0.018	5502	42.70	0.004	0.022	5520
61	EAA	0.077	5,500	1.000	5503	24.71	0.018	5503	42.70	0.004	0.022	5517
62	ETG	0.076	5,500	1.000	5500	24.70	0.018	5500	42.68	0.004	0.022	5500
63	ETA	0.119	5,500	1.090	5995	26.92	0.033	5995	46.52	0.008	0.041	7504
64	EAA	0.079	5,500	1.004	5522	24.79	0.019	5522	42.85	0.004	0.023	5639
65	EAL	0.086	5,500	1.070	5885	26.42	0.023	5885	45.67	0.005	0.029	6255
66	ETB	0.083	5,500	1.012	5566	24.99	0.020	5566	43.19	0.005	0.025	5824
67	EBT	0.078	5,500	1.002	5513	24.75	0.018	5513	42.78	0.004	0.023	5564
68	EBE	0.078	5,500	1.004	5521	24.79	0.019	5521	42.85	0.004	0.023	5602
69	EBR	0.090	5,500	1.020	5610	25.19	0.022	5610	43.54	0.005	0.027	6107
70	ECY	0.083	5,500	1.010	5555	24.94	0.020	5555	43.11	0.005	0.025	5796
71	EDC	0.122	5,500	1.080	5940	26.67	0.033	5940	46.10	0.008	0.041	7508
72	EGL	0.076	5,500	1.000	5501	24.70	0.018	5501	42.69	0.004	0.022	5503
73	EMA	0.077	5,500	1.001	5506	24.72	0.018	5506	42.72	0.004	0.022	5544
74	EGY	0.076	5,500	1.000	5501	24.70	0.018	5501	42.69	0.004	0.022	5508
75	EPE	0.076	5,500	1.000	5501	24.70	0.018	5501	42.69	0.004	0.022	5508
76	EEP	0.076	5,500	1.000	5501	24.70	0.018	5501	42.69	0.004	0.022	5510
77	EHX	0.076	5,500	1.000	5502	24.71	0.018	5502	42.70	0.004	0.022	5514
78	EPR	0.086	5,500	1.070	5885	26.42	0.023	5885	45.67	0.005	0.029	6255
79	ETE	0.080	5,500	1.006	5531	24.83	0.019	5531	42.92	0.004	0.024	5679
80	FAM	0.076	5,500	1.002	5511	24.74	0.018	5511	42.77	0.004	0.022	5520
81	FMS	0.076	5,500	1.003	5517	24.77	0.018	5517	42.81	0.004	0.022	5517
82	FAL	0.077	5,500	1.001	5506	24.72	0.018	5506	42.72	0.004	0.022	5526
83	FFA	0.078	5,500	1.003	5517	24.77	0.018	5517	42.81	0.004	0.023	5575
84	GAK	0.217	5,500	1.250	6875	30.87	0.080	6875	53.35			

Pipe run #1	Pipe run #2
Description: 8" Branch (Exp trunk to vapor stack)	Description: 6" branch at P-V valve
Pipe ID: 7.98 (in)	Pipe ID: 6.07 (in)
Equiv. Pipe Length (table 2a): 170.4 (feet)	Equiv. Pipe Length (table 2b): 9.4 (feet)
Darcy friction factor: 0.014	Darcy friction factor: 0.015

CHRIS Code	Name	Vapor-air Mixture Weight Density (from Table 1) (lb/ft ³)	Liquid Transfer Rate (filling) (bbl/hr)	Vapor Growth Rate	Vapor Volumetric Flow Rate (bbl/hr)	Mean Velocity (ft/s)	Pressure Drop (pipe run #1) (psig)	Vapor Volumetric Flow Rate (bbl/hr)	Mean Velocity (ft/s)	Pressure Drop (pipe run #2) (psig)	Pressure Drop (Total) (psig)	Air Equiv. Volumetric Flow Rate (bbl/hr)	
100	HXG	Hexylene Glycol	0.076	5,500	1.000	5501	24.70	0.018	5501	42.69	0.004	0.022	5501
101	IPH	Isophorone	0.076	5,500	1.000	5501	24.70	0.018	5501	42.69	0.004	0.022	5507
102	JPF	Jet Fuels: JP-4	0.124	5,500	1.068	5874	26.37	0.033	5874	45.58	0.008	0.041	7499
103	JPV	Jet Fuels JP-5 (Kerosene. heavy)	0.078	5,500	1.002	5511	24.74	0.018	5511	42.77	0.004	0.023	5562
104	KRS	Kerosene	0.079	5,500	1.003	5517	24.77	0.019	5517	42.81	0.004	0.023	5605
105	MTT	Methyl Acetate	0.122	5,500	1.122	6171	27.71	0.036	6171	47.89	0.008	0.045	7812
106	MAL	Methyl Alcohol (Methanol)	0.079	5,500	1.133	6229	27.97	0.024	6229	48.34	0.006	0.030	6355
107	MAC	Methylamyl Acetate	0.082	5,500	1.007	5536	24.86	0.020	5536	42.96	0.005	0.024	5756
108	MAA	Methylamyl Alcohol	0.081	5,500	1.009	5547	24.91	0.019	5547	43.05	0.005	0.024	5730
109	MAK	Methylamyl Keytone	0.076	5,500	1.001	5506	24.72	0.018	5506	42.72	0.004	0.022	5506
110	MAM	Methyl Acrylate	0.115	5,500	1.082	5951	26.72	0.032	5951	46.18	0.007	0.039	7303
111	MBE	Methyl Tert-Butyl Ether (MTBE)	0.077	5,500	1.001	5504	24.72	0.018	5504	42.72	0.004	0.022	5519
112	MBK	Methyl Butyl Ketone	0.088	5,500	1.019	5607	25.17	0.021	5607	43.51	0.005	0.026	6012
113	MBU	Methyl Butyrate	0.091	5,500	1.025	5639	25.32	0.023	5639	43.76	0.005	0.028	6168
114	MEK	Methyl Ethyl Ketone	0.108	5,500	1.090	5995	26.92	0.030	5995	46.52	0.007	0.037	7135
115	MHK	Methyl Heptyl Ketone	0.077	5,500	1.001	5507	24.73	0.018	5507	42.73	0.004	0.023	5546
116	MIK	Methyl Isobutyl Ketone	0.089	5,500	1.023	5627	25.26	0.022	5627	43.66	0.005	0.027	6096
117	MMM	Methyl methacrylate	0.099	5,500	1.040	5722	25.69	0.025	5722	44.41	0.006	0.031	6538
118	MNA	Methyl Naphthalene	0.076	5,500	1.000	5501	24.70	0.018	5501	42.69	0.004	0.022	5508
119	MNS	Mineral Spirits	0.079	5,500	1.004	5522	24.79	0.019	5522	42.85	0.004	0.023	5633
120	MPL	Morpholine	0.084	5,500	1.016	5588	25.09	0.020	5588	43.36	0.005	0.025	5857
121	MRE	Myrcene	0.079	5,500	1.003	5519	24.78	0.019	5519	42.83	0.004	0.023	5625
122	PTN	Naphtha: Petroleum	0.078	5,500	1.004	5521	24.79	0.019	5521	42.84	0.004	0.023	5600
123	NSV	Naphtha: Solvent	0.078	5,500	1.004	5522	24.79	0.019	5522	42.85	0.004	0.023	5607
124	NSS	Naphtha: Stoddard Solvent	0.079	5,500	1.004	5522	24.79	0.019	5522	42.85	0.004	0.023	5633
125	NVM	Naphtha: VM&P	0.079	5,500	1.004	5521	24.79	0.019	5521	42.84	0.004	0.023	5627
126	NAX	Nonane (all isomers)	0.080	5,500	1.005	5530	24.83	0.019	5530	42.91	0.004	0.024	5684
127	NON	Nonene (all isomers)	0.082	5,500	1.007	5539	24.87	0.020	5539	42.98	0.005	0.024	5733
128	NNS	Nonyl Alcohol (all isomers)	0.078	5,500	1.002	5511	24.74	0.018	5511	42.77	0.004	0.023	5579
129	NNP	Nonyl Phenol	0.076	5,500	1.000	5501	24.70	0.018	5501	42.69	0.004	0.022	5512
130	NPM	1-, 2-Nitropropane	0.086	5,500	1.021	5616	25.21	0.021	5616	43.58	0.005	0.026	5979
131	OAX	Octane (all isomers)	0.087	5,500	1.016	5587	25.09	0.021	5587	43.36	0.005	0.026	5969
132	OCX	Octanol (all isomers)	0.076	5,500	1.000	5501	24.70	0.018	5501	42.69	0.004	0.022	5507
133	OTX	Octene (all isomers)	0.088	5,500	1.018	5599	25.14	0.022	5599	43.45	0.005	0.027	6033
134	OTW	Oil, fuel: No. 2	0.095	5,500	1.011	5562	24.97	0.023	5562	43.16	0.005	0.028	6198
135	OTD	Oil, fuel: No. 2-D	0.084	5,500	1.014	5576	25.04	0.020	5576	43.27	0.005	0.025	5853
136	OFR	Oil, fuel: No. 4	0.078	5,500	1.003	5517	24.77	0.018	5517	42.81	0.004	0.023	5577
137	OFV	Oil, fuel: No. 5	0.078	5,500	1.003	5517	24.77	0.018	5517	42.81	0.004	0.023	5577
138	OSX	Oil, fuel: No. 6	0.078	5,500	1.003	5517	24.77	0.018	5517	42.81	0.004	0.023	5577
139	OIL	Oil, misc: Crude	0.078	5,500	1.250	6875	30.87	0.029	6875	53.35	0.007	0.035	6951
140	ODS	Oil, Misc: Diesel	0.084	5,500	1.014	5576	25.04	0.020	5576	43.27	0.005	0.025	5854
141	OLB	Oil, Misc: Lubricating	0.076	5,500	1.003	5517	24.77	0.018	5517	42.81	0.004	0.022	5517
142	ORL	Oil, Misc: Residual	0.076	5,500	1.003	5517	24.77	0.018	5517	42.81	0.004	0.022	5517
143	OTB	Oil, Misc: Turbine	0.082	5,500	1.006	5533	24.84	0.020	5533	42.94	0.005	0.024	5754
144	PTY	Pentane (all isomers)	0.350	5,500	1.540	8470	38.03	0.196	8470	65.73	0.045	0.241	18150
145	PTE	Pentene (all isomers)	0.310	5,500	1.499	8245	37.02	0.164	8245	63.98	0.038	0.203	16640
146	PIN	Pinene	0.083	5,500	1.008	5542	24.88	0.020	5542	43.01	0.005	0.024	5777
147	PLB	Polybutene	0.076	5,500	1.000	5501	24.70	0.018	5501	42.69	0.004	0.022	5501
148	PGC	Polypropylene Glycol	0.076	5,500	1.002	5511	24.74	0.018	5511	42.77	0.004	0.022	5511
149	IAC	Propyl Acetate (iso-)	0.097	5,500	1.036	5698	25.58	0.025	5698	44.22	0.006	0.030	6447
150	PAT	Propyl Acetate (n-)	0.098	5,500	1.037	5704	25.61	0.025	5704	44.26	0.006	0.031	6472
151	IPA	Propyl Alcohol (iso-)	0.091	5,500	1.060	5830	26.18	0.024	5830	45.24	0.006	0.030	6382
152	PAL	Propyl Alcohol (n-)	0.082	5,500	1.024	5632	25.29	0.020	5632	43.71	0.005	0.025	5851
153	PBY	Propylbenzene (all isomers)	0.079	5,500	1.004	5522	24.79	0.019	5522	42.85	0.004	0.023	5628
154	IPX	iso-Propylcyclohexane	0.076	5,500	1.000	5501	24.70	0.018	5501	42.69	0.004	0.022	5507
155	PPG	Propylene Glycol	0.076	5,500	1.000	5501	24.70	0.018	5501	42.69	0.004	0.022	5504
156	PGN	Propylene Glycol Methyl Ether Acetate	0.083	5,500	1.014	5577	25.04	0.020	5577	43.28	0.005	0.025	5826
157	PTT	Propylene Tetramer	0.076	5,500	1.000	5502	24.71	0.018	5502	42.70	0.004	0.022	5502
158	SFL	Sulfolane	0.076	5,500	1.000	5501	24.70	0.018	5501	42.69	0.004	0.022	5506
159	STY	Styrene	0.081	5,500	1.008	5544	24.89	0.019	5544	43.02	0.005	0.024	5719
160	TTG	Tetraethylene Glycol	0.076	5,500	1.000	5501	24.70	0.018	5501	42.69	0.004	0.022	5511
161	THN	Tetrahydronaphthalene	0.077	5,500	1.001	5504	24.72	0.018	5504	42.72	0.004	0.022	5529
162	TOL	Toluene	0.091	5,500	1.030	5665	25.44	0.023	5665	43.96	0.005	0.028	6201
163	TCN	1,2,3-Trichloropropane	0.079	5,500	1.003	5517	24.77	0.019	5517	42.81	0.004	0.023	5633
164	TCP	Tricresyl Phosphate (less than 1% of ortho isomer)	0.077	5,500	1.000	5501	24.70	0.018	5501	42.69	0.004	0.022	5521
165	TEB	Triethylbenzene	0.077	5,500	1.000	5502	24.71	0.018	5502	42.70	0.004	0.022	5518
166	TEN	Triethylamine	0.105	5,500	1.050	5775	25.93	0.027	5775	44.82	0.006	0.034	6795
167	TEG	Triethylene Glycol	0.076	5,500	1.000	5501	24.70	0.018	5501	42.69	0.004	0.022	5508
168	TPS	Triethyl Phosphate	0.077	5,500	1.001	5503	24.71	0.018	5503	42.71	0.004	0.022	5530
169	TRE	Trimethylbenzene (all isomers)	0.078	5,500	1.003	5515	24.76	0.019	5515	42.80	0.004	0.023	5588
170	TRP	Trixylenyl Phosphate	0.076	5,500	1.000	5500	24.70	0.018	5500	42.68	0.004	0.022	5500
171	THF	Tetrahydrofuran	0.090	5,500	1.170	6435	28.89	0.029	6435	49.94	0.007	0.036	7001
172	UDC	Undecene	0.077	5,500	1.001	5506	24.72	0.018	5506	42.72	0.004	0.022	5542
173	LND	Undecyl Alcohol	0.076	5,500	1.000	5501	24.70	0.018	5501	42.69	0.004	0.022	5509
174	VAM	Vinyl Acetate	0.130	5,500	1.116	6138	27.56	0.038	6138	47.63	0.009	0.047	8015
175	XLX	Xylenes (ortho-, meta-, para-)	0.083	5,500	1.010	5556	24.95	0.020	5556	43.12	0.005	0.024	5786

max = 0.241 18150

Greatest pressure drop to P-V valve: 0.24 (psig) Pentane (all isomers)

High velocity P-V valve pressure setting: 1.50 (psig)
 Back pressure imposed by P-V valve @ highest flow rate: 2.64 (psig)
 Total back pressure imposed on cargo tank by venting: 2.88 (psig)
 Max design working pressure of tanks: 3.00 (psig)

Conclusion: At the maximum cargo loading rate, the total back pressure imposed by the tank venting system does not exceed the maximum design working pressure of the tanks.

B. Check vacuum relieving capacity at maximum discharge rate:

Opening vacuum setting for PV Valve: 0.5 (psig)

Maximum discharge rate (total): 4300 (bbl/hr)

Corresponding vacuum at max discharge rate: (see attached PV valve flow capacity curve) 0.47 (psig)

Table 4 Calculation of the Maximum Liquid Transfer Rate as Imposed by the pressure drop between the most remote tank and the facility vapor connection (Ref: 46 CFR 39.30-1(d)(3):

Note: Darcy's equation will be used to estimate the pressure drop of the vapor-air mixture through the vent piping from the farthest tank in terms of equivalent pipe length (#1P) to the facility connection. Equivalent length for this path is calculated using Crane's Technical Paper 410 (Ref. 4) and Cameron Hydraulic Data handbook (Ref. 9)

Calculate equivalent lengths of pipe:

- a. Pipe run #1
 Description: 8" Piping
 Pipe size, nominal: 8" sch. 40 pipe
 Pipe ID (inches): 7.98

Item	Description	Size (in)	Qty	Unit Equivalent Length (ft)	Total Equivalent Length (ft)
1	Entrance	8	1	23.3	23.3
2	Straight Pipe	8	1	195.0	195.0
3	Tee, branch	8	2	39.9	79.8
4	Tee, run	8	3	13.3	39.9
5	Elbow, 45 deg.	8	2	10.2	20.4
6	Valve, Gate	8	1	8.6	8.6
7	Hose	8	1	50.0	50.0
	Sum (pipe run #1)				417.0

Table 5 Calculation of the Maximum Liquid Transfer Rate as Imposed by the pressure drop between the most remote tank and the facility vapor connection (Ref: 46 CFR 39.30-1(d)(3) (continued):

1. Calculate pressure drop using Darcy's equation:

Pipe run #1	
Description:	8" Piping
Pipe ID:	7.98 (in)
Equivalent Length of Pipe (from Table 4a):	417.0 (feet)
Darcy friction factor:	0.014

	CHRIS Code	Name	Vapor-air Mixture Weight Density (from Table 1) (lb/ft ³)	Liquid Transfer Rate (filling) (bbl/hr)	Vapor Growth Rate	Vapor Volumetric Flow Rate (bbl/hr)	Mean Velocity (ft/s)	Pressure Drop (pipe run #1) (psig)	Pressure Drop (Total) (psig)	Air Equivalent Volumetric Flow Rate (bbl/hr)
1	ACN	Acrylonitrile	0.095	5,500	1.100	6050	27.16	0.066	0.066	6756
2	ACT	Acetone	0.123	5,500	1.200	6600	29.63	0.102	0.102	8393
3	ACP	Acetophenone	0.085	5,500	1.012	5566	24.99	0.050	0.050	5881
4	AND	Adiponitrile	0.076	5,500	1.000	5501	24.70	0.044	0.044	5506
5	AEC	Amyl acetate (all isomers)	0.075	5,500	1.007	5536	24.86	0.044	0.044	5485
6	AAI	Amyl Alcohol (iso-, n-, sec-, primary)	0.079	5,500	1.006	5533	24.84	0.046	0.046	5637
7	ATN	Acetonitrile	0.076	5,500	1.001	5503	24.71	0.044	0.044	5505
8	BAL	Benzyl Alcohol	0.077	5,500	1.002	5511	24.74	0.045	0.045	5557
9	BNZ	Benzene	0.114	5,500	1.250	6875	30.87	0.103	0.103	8420
10	BTX	Benzene, Toluene, Xylene mixtures (10% Benzene)	0.138	5,500	1.250	6875	30.87	0.124	0.124	9252
11	BAR	Butyl Acrylate (iso-, n-)	0.086	5,500	1.012	5566	24.99	0.051	0.051	5908
12	BAX	Butyl Acetate (all isomers)	0.085	5,500	1.012	5566	24.99	0.050	0.050	5867
13	IAL	Butyl Alcohol (iso-)	0.083	5,500	1.018	5599	25.14	0.050	0.050	5843
14	BAN	Butyl Alcohol (n-)	0.074	5,500	1.010	5555	24.94	0.044	0.044	5477
15	BAS	Butyl Alcohol (sec-)	0.086	5,500	1.026	5643	25.34	0.052	0.052	5994
16	BAT	Butyl Alcohol (tert-)	0.097	5,500	1.056	5808	26.08	0.063	0.063	6562
17	BPH	Butyl Benzyl Phthalate	0.077	5,500	1.000	5501	24.70	0.044	0.044	5518
18	BAD	iso-Butyraldehyde	0.131	5,500	1.156	6358	28.55	0.101	0.101	8344
19	BTR	n-Butyraldehyde	0.131	5,500	1.156	6358	28.55	0.101	0.101	8344
20	BUE	Butyl Toluene	0.078	5,500	1.002	5511	24.74	0.045	0.045	5580
21	CLS	Caprolactam Solutions	0.077	5,500	1.001	5506	24.72	0.044	0.044	5530
22	CCH	Cyclohexanone	0.078	5,500	1.004	5522	24.79	0.046	0.046	5603
23	CHA	Cyclohexylamine	0.083	5,500	1.012	5568	25.00	0.049	0.049	5820
24	CHX	Cyclohexane	0.116	5,500	1.090	5995	26.92	0.080	0.080	7410
25	CHN	Cyclohexanol	0.078	5,500	1.003	5517	24.77	0.045	0.045	5579
26	CPD	1,3-Cyclopentadiene dimer (molten)	0.080	5,500	1.005	5528	24.82	0.047	0.047	5677
27	CMP	p-Cymene	0.078	5,500	1.002	5512	24.75	0.045	0.045	5579
28	CRB	Chlorobenzene	0.087	5,500	1.016	5588	25.09	0.052	0.052	5972
29	CRS	Cresols	0.077	5,500	1.002	5509	24.73	0.045	0.045	5546
46	DTL	Dimethyl Phthalate	0.076	5,500	1.000	5500	24.70	0.044	0.044	5500
47	DOP	Diocyl Phthalate	0.076	5,500	1.000	5500	24.70	0.044	0.044	5500
48	DPN	Dipentene	0.078	5,500	1.002	5511	24.74	0.045	0.045	5577
49	DIL	Diphenyl	0.076	5,500	1.000	5501	24.70	0.044	0.044	5508
50	DDO	Diphenyl, Diphenyl Ether Mixtures	0.076	5,500	1.000	5501	24.70	0.044	0.044	5509
51	DMF	Dimethylformamide	0.078	5,500	1.006	5533	24.84	0.046	0.046	5610
52	DPE	Diphenyl Ether	0.076	5,500	1.000	5501	24.70	0.044	0.044	5509
53	DPG	Dipropylene Glycol	0.077	5,500	1.001	5508	24.73	0.045	0.045	5551
54	DPX	1,1-, 1,2-, 1,3-Dichloropropane	0.162	5,500	1.126	6193	27.81	0.119	0.119	9034
55	DFF	Distillates Flashed Feed Stocks	0.102	5,500	1.046	5753	25.83	0.064	0.064	6661
56	DSR	Distillates Straight Run	0.102	5,500	1.046	5753	25.83	0.064	0.064	6661
57	DOZ	Dodecene (all isomers)	0.077	5,500	1.000	5502	24.71	0.044	0.044	5519
58	DDB	Dodecylbenzene	0.240	5,500	1.250	6875	30.87	0.216	0.216	12196
59	EAC	Ethyl Acrylate	0.100	5,500	1.040	5720	25.68	0.062	0.062	6543
60	EAI	2-Ethylhexyl acrylate	0.077	5,500	1.000	5502	24.71	0.044	0.044	5520
61	EEA	2-Ethoxyethyl acetate	0.077	5,500	1.000	5503	24.71	0.044	0.044	5517
62	ETG	Ethoxy Triglycol (crude)	0.076	5,500	1.000	5500	24.70	0.044	0.044	5500
63	ETA	Ethyl Acetate	0.119	5,500	1.090	5995	26.92	0.082	0.082	7504
64	EA	Ethyl Acetoacetate	0.079	5,500	1.004	5522	24.79	0.046	0.046	5639
65	EAL	Ethyl Alcohol (Ethanol)	0.086	5,500	1.070	5885	26.42	0.057	0.057	6255
66	ETB	Ethyl Benzene	0.083	5,500	1.012	5566	24.99	0.049	0.049	5824
67	EBT	Ethyl Butanol	0.078	5,500	1.002	5513	24.75	0.045	0.045	5564
68	EBE	Ethyl tert-butyl ether	0.078	5,500	1.004	5521	24.79	0.046	0.046	5602
69	EBR	Ethyl butyrate	0.090	5,500	1.020	5610	25.19	0.054	0.054	6107
70	ECY	Ethyl Cyclohexane	0.083	5,500	1.010	5555	24.94	0.049	0.049	5796
71	EDC	Ethylene dichloride	0.122	5,500	1.080	5940	26.67	0.082	0.082	7508
72	EGL	Ethylene Glycol	0.076	5,500	1.000	5501	24.70	0.044	0.044	5503
73	EMA	Ethylene Glycol Butyl Ether Acetate	0.077	5,500	1.001	5506	24.72	0.045	0.045	5544
74	EGY	Ethylene Glycol Diacetate	0.076	5,500	1.000	5501	24.70	0.044	0.044	5508
75	EPE	Ethylene Glycol Phenyl Ether	0.076	5,500	1.000	5501	24.70	0.044	0.044	5508
76	EEP	Ethyl-3-ethoxypropionate	0.076	5,500	1.000	5501	24.70	0.044	0.044	5510
77	EHX	2-Ethylhexanol	0.076	5,500	1.000	5502	24.71	0.044	0.044	5514
78	EPR	Ethyl Propionate	0.086	5,500	1.070	5885	26.42	0.057	0.057	6255
79	ETE	Ethyl Toluene	0.080	5,500	1.006	5531	24.83	0.047	0.047	5679
80	FAM	Formamide	0.076	5,500	1.002	5511	24.74	0.044	0.044	5520
81	FMS	Formaldehyde Solution	0.076	5,500	1.003	5517	24.77	0.044	0.044	5517
82	FAL	Furfuryl Alcohol	0.077	5,500	1.001	5506	24.72	0.044	0.044	5526
83	FFA	Furfural	0.078	5,500	1.003	5517	24.77	0.045	0.045	5575
84	GAK	Gasoline Blending Stocks: Alkylates	0.217	5,500	1.250	6875	30.87	0.196	0.196	11610
85	GRF	Gasoline Blending Stocks: Reformates	0.217	5,500	1.250	6875	30.87	0.196	0.196	11610
86	GAT	Gasolines: Automotive	0.217	5,500	1.250	6875	30.87	0.196	0.196	11610
87	GAV	Gasolines: Aviation	0.217	5,500	1.250	6875	30.87	0.196	0.196	11610
88	GCS	Gasolines: Casinghead	0.217	5,500	1.250	6875	30.87	0.196	0.196	11610
89	GPL	Gasolines: Polymer	0.217	5,500	1.250	6875	30.87	0.196	0.196	11610
90	GSR	Gasolines: StraightRun	0.217	5,500	1.250	6875	30.87	0.196	0.196	11610
91	GCR	Glycerine	0.076	5,500	1.000	5500	24.70	0.044	0.044	5500
92	HMX	Heptane (all isomers)	0.105	5,500	1.050	5775	25.93	0.067	0.067	6779
93	HEP	Heptonic Acid	0.076	5,500	1.000	5501	24.70	0.044	0.044	5507
94	HTX	Heptanol (all isomers)	0.077	5,500	1.001	5504	24.72	0.044	0.044	5525
95	HPX	Heptene (all isomers)	0.109	5,500	1.058	5819	26.13	0.070	0.070	6958
96	HXS	Hexane (all isomers)	0.142	5,500	1.140	6270	28.15	0.106	0.106	8561
97	HXO	Hexanoic Acid	0.076	5,500	1.000	5501	24.70	0.044	0.044	5506
98	HXN	Hexanol	0.088	5,500	1.020	5610	25.19	0.053	0.053	6031
99	HEX	Hexene (all isomers)	0.148	5,500	1.160	6380	28.65	0.115	0.115	8882
100	HXG	Hexylene Glycol	0.076	5,500	1.000	5501	24.70	0.044	0.044	5501
101	IPH	Isophorone	0.076	5,500	1.000	5501	24.70	0.044	0.044	5507
102	JPF	Jet Fuels: JP-4	0.124	5,500	1.068	5874	26.37	0.082	0.082	7499
103	JPV	Jet Fuels JP-5 (Kerosene, heavy)	0.078	5,500	1.002	5511	24.74	0.045	0.045	5562
104	KRS	Kerosene	0.079	5,500	1.003	5517	24.77	0.046	0.046	5605
105	MTT	Methyl Acetate	0.122	5,500	1.122	6171	27.71	0.089	0.089	7812
106	MAL	Methyl Alcohol (Methanol)	0.079	5,500	1.133	6229	27.97	0.059	0.059	6355
107	MAC	Methylamyl Acetate	0.082	5,500	1.007	5536	24.86	0.048	0.048	5756
108	MAA	Methylamyl Alcohol	0.081	5,500	1.009	5547	24.91	0.048	0.048	5730
109	MAK	Methylamyl Keytone	0.076	5,500	1.001	5506	24.72	0.044	0.044	5506
110	MAM	Methyl Acrylate	0.115	5,500	1.082	5951	26.72	0.078	0.078	7303

Pipe run #1			
Description:	8" Piping		
Pipe ID:	7.98 (in)		
Equivalent Length of Pipe (from Table 4a):	417.0 (feet)		
Darcy friction factor:	0.014		

111	MBE	Methyl Tert-Butyl Ether (MTBE)	0.077	5,500	1.001	5504	24.72	0.044	0.044	5519
112	MBK	Methyl Butyl Ketone	0.088	5,500	1.019	5607	25.17	0.053	0.053	6012
113	MBU	Methyl Butyrate	0.091	5,500	1.025	5639	25.32	0.055	0.055	6168
114	MEK	Methyl Ethyl Ketone	0.108	5,500	1.090	5995	26.92	0.074	0.074	7135
115	MHK	Methyl Heptyl Ketone	0.077	5,500	1.001	5507	24.73	0.045	0.045	5546
116	MIK	Methyl Isobutyl Ketone	0.089	5,500	1.023	5627	25.26	0.054	0.054	6096
117	MMM	Methyl methacrylate	0.099	5,500	1.040	5722	25.69	0.062	0.062	6538
118	MNA	Methyl Naphthalene	0.076	5,500	1.000	5501	24.70	0.044	0.044	5508
119	MNS	Mineral Spirits	0.079	5,500	1.004	5522	24.79	0.046	0.046	5633
120	MPL	Morpholine	0.084	5,500	1.016	5588	25.09	0.050	0.050	5857
121	MRE	Myrcene	0.079	5,500	1.003	5519	24.78	0.046	0.046	5625
122	PTN	Naphtha: Petroleum	0.078	5,500	1.004	5521	24.79	0.046	0.046	5600
123	NSV	Naphtha: Solvent	0.078	5,500	1.004	5522	24.79	0.046	0.046	5607
124	NSS	Naphtha: Stoddard Solvent	0.079	5,500	1.004	5522	24.79	0.046	0.046	5633
125	NVM	Naphtha: VM&P	0.079	5,500	1.004	5521	24.79	0.046	0.046	5627
126	NAX	Nonane (all isomers)	0.080	5,500	1.005	5530	24.83	0.047	0.047	5684
127	NON	Nonene (all isomers)	0.082	5,500	1.007	5539	24.87	0.048	0.048	5733
128	NNS	Nonyl Alcohol (all isomers)	0.078	5,500	1.002	5511	24.74	0.045	0.045	5579
129	NNP	Nonyl Phenol	0.076	5,500	1.000	5501	24.70	0.044	0.044	5512
130	NPM	1-, 2-Nitropropane	0.086	5,500	1.021	5616	25.21	0.052	0.052	5979
131	OAX	Octane (all isomers)	0.087	5,500	1.016	5587	25.09	0.052	0.052	5969
132	OXC	Octanol (all isomers)	0.076	5,500	1.000	5501	24.70	0.044	0.044	5507
133	OTX	Octene (all isomers)	0.088	5,500	1.018	5599	25.14	0.053	0.053	6033
134	OTW	Oil, fuel: No. 2	0.095	5,500	1.011	5562	24.97	0.056	0.056	6198
135	OTD	Oil, fuel: No. 2-D	0.084	5,500	1.014	5576	25.04	0.050	0.050	5853
136	OFR	Oil, fuel: No. 4	0.078	5,500	1.003	5517	24.77	0.045	0.045	5577
137	OFV	Oil, fuel: No. 5	0.078	5,500	1.003	5517	24.77	0.045	0.045	5577
138	OSX	Oil, fuel: No. 6	0.078	5,500	1.003	5517	24.77	0.045	0.045	5577
139	OIL	Oil, misc: Crude	0.078	5,500	1.250	6875	30.87	0.070	0.070	6951
140	ODS	Oil, Misc: Diesel	0.084	5,500	1.014	5576	25.04	0.050	0.050	5854
141	OLB	Oil, Misc: Lubricating	0.076	5,500	1.003	5517	24.77	0.044	0.044	5517
142	ORL	Oil, Misc: Residual	0.076	5,500	1.003	5517	24.77	0.044	0.044	5517
143	OTB	Oil, Misc: Turbine	0.082	5,500	1.006	5533	24.84	0.048	0.048	5754
144	PTY	Pentane (all isomers)	0.350	5,500	1.540	8470	38.03	0.479	0.479	18150
145	PTE	Pentene (all isomers)	0.310	5,500	1.499	8245	37.02	0.402	0.402	16640
146	PIN	Pinene	0.083	5,500	1.008	5542	24.88	0.048	0.048	5777
147	PLB	Polybutene	0.076	5,500	1.000	5501	24.70	0.044	0.044	5501
148	PGC	Polypropylene Glycol	0.076	5,500	1.002	5511	24.74	0.044	0.044	5511
149	IAC	Propyl Acetate (iso-)	0.097	5,500	1.036	5698	25.58	0.060	0.060	6447
150	PAT	Propyl Acetate (n-)	0.098	5,500	1.037	5704	25.61	0.061	0.061	6472
151	IPA	Propyl Alcohol (iso-)	0.091	5,500	1.060	5830	26.18	0.059	0.059	6382
152	PAL	Propyl Alcohol (n-)	0.082	5,500	1.024	5632	25.29	0.050	0.050	5851
153	PBY	Propylbenzene (all isomers)	0.079	5,500	1.004	5522	24.79	0.046	0.046	5628
154	IPX	iso-Propylcyclohexane	0.076	5,500	1.000	5501	24.70	0.044	0.044	5507
155	PPG	Propylene Glycol	0.076	5,500	1.000	5501	24.70	0.044	0.044	5504
156	PGN	Propylene Glycol Methyl Ether Acetate	0.083	5,500	1.014	5577	25.04	0.049	0.049	5826
157	PTT	Propylene Tetramer	0.076	5,500	1.000	5502	24.71	0.044	0.044	5502
158	SFL	Sulfolane	0.076	5,500	1.000	5501	24.70	0.044	0.044	5506
159	STY	Styrene	0.081	5,500	1.008	5544	24.89	0.048	0.048	5719
160	TTG	Tetraethylene Glycol	0.076	5,500	1.000	5501	24.70	0.044	0.044	5511
161	THN	Tetrahydronaphthalene	0.077	5,500	1.001	5504	24.72	0.044	0.044	5529
162	TOL	Toluene	0.091	5,500	1.030	5665	25.44	0.056	0.056	6201
163	TCN	1,2,3-Trichloropropane	0.079	5,500	1.003	5517	24.77	0.046	0.046	5633
164	TCP	Tricresyl Phosphate (less than 1% of ortho isomer)	0.077	5,500	1.000	5501	24.70	0.044	0.044	5521
165	TEB	Triethylbenzene	0.077	5,500	1.000	5502	24.71	0.044	0.044	5518
166	TEN	Triethylamine	0.105	5,500	1.050	5775	25.93	0.067	0.067	6795
167	TEG	Triethylene Glycol	0.076	5,500	1.000	5501	24.70	0.044	0.044	5508
168	TPS	Triethyl Phosphate	0.077	5,500	1.001	5503	24.71	0.044	0.044	5530
169	TRE	Trimethylbenzene (all isomers)	0.078	5,500	1.003	5515	24.76	0.045	0.045	5588
170	TRP	Trixylenyl Phosphate	0.076	5,500	1.000	5500	24.70	0.044	0.044	5500
171	THF	Tetrahydrofuran	0.090	5,500	1.170	6435	28.89	0.071	0.071	7001
172	UDC	Undecene	0.077	5,500	1.001	5506	24.72	0.045	0.045	5542
173	UND	Undecyl Alcohol	0.076	5,500	1.000	5501	24.70	0.044	0.044	5509
174	VAM	Vinyl Acetate	0.130	5,500	1.116	6138	27.56	0.093	0.093	8015
175	XLX	Xylenes (ortho-, meta-, para-)	0.083	5,500	1.010	5556	24.95	0.049	0.049	5786
max = 0.479										
18150										

2. Compare pressure drop to P-V valve pressure settings:
 - a. High-velocity P-V Valve pressure setting: 1.50 (psig)
 - b. Cargo tank P-V Valve pressure setting: 1.50 (psig)
 - c. 80% of lowest P-V Valve Pressure Setting: 1.20 (psig)
 - d. Highest Pressure Drop from Tank to Facility Connection: 0.48 (psig)
 - e. Max Allowable Back Pressure at Facility Connection: 0.72 (psig)

0.48 (psig) for Pentane (all isomers)

Conclusion:
 For the cargo with the highest pressure drop (Pentane), the pressure drop is 0.48 psig. This, when added to the back pressure at the facility vapor connection must not exceed 80% of the pressure setting of any P-V valve in the cargo tank venting system. Therefore, the maximum allowable back pressure at the shore facility must not exceed 0.72 psig when loading with Pentane at the maximum liquid transfer rate (5,500 bbl/hr).

Graphs as required by 46 CFR 39.30-1(b)(3)

Curve of Loading Rate vs. Pressure Drop

Conrad Hulls C890, H407

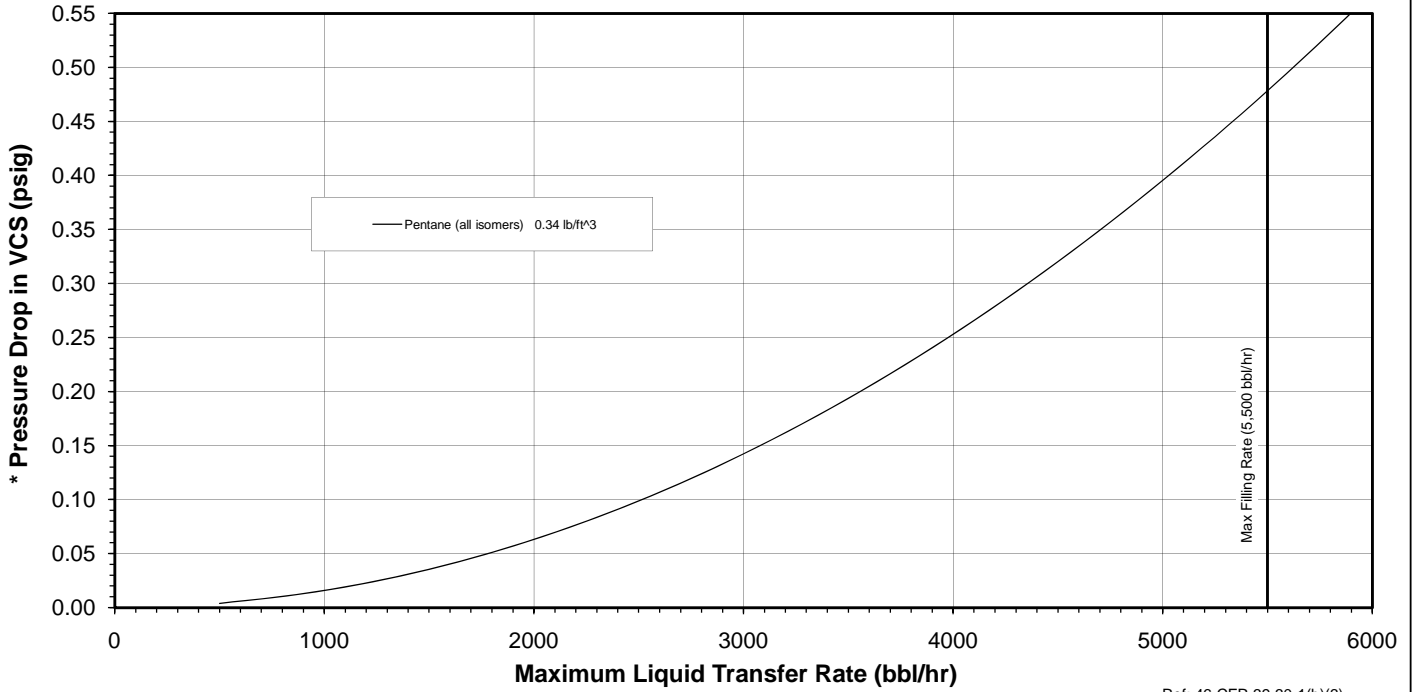

Curve of Allowable Back Pressure at Facility Connection

Conrad Hulls C890, H407

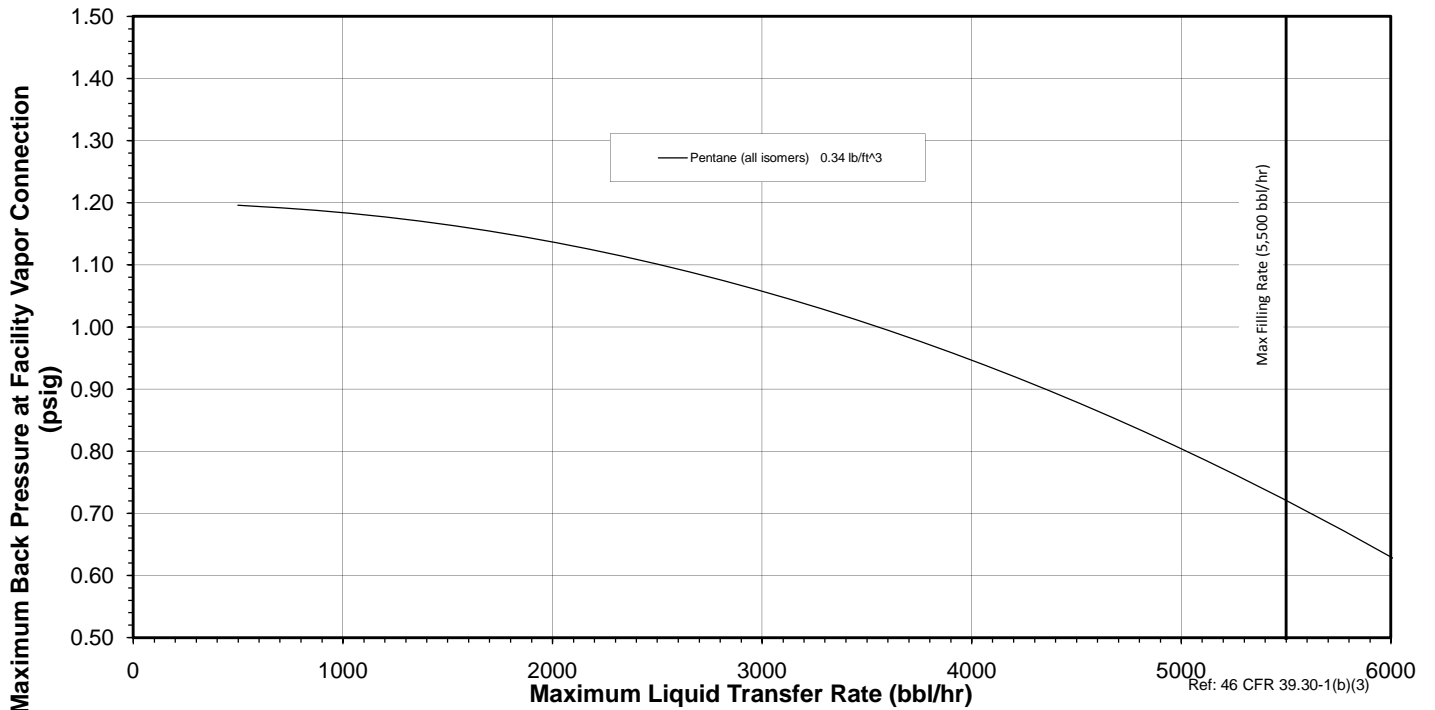

Conrad C890 / Orange H407
Calculation of Overfill Alarm Set Point
(Cargo Tank No. 1 P/S)

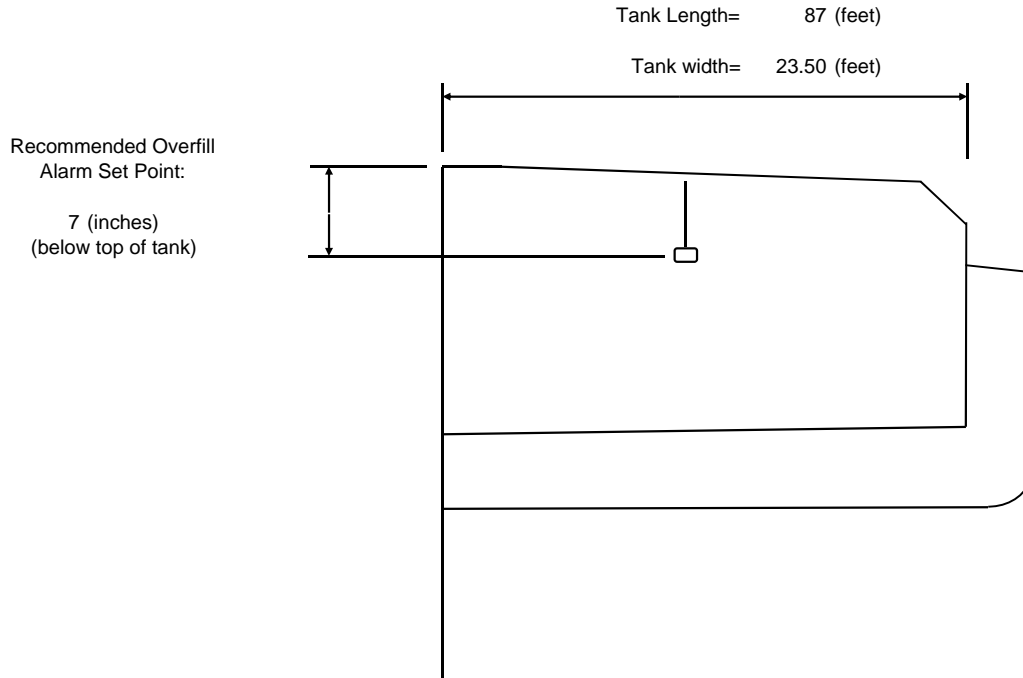

Maximum (per tank) Cargo Loading Rate	=	5,500 (bbl/hr)	
	=	91.67 (bbl/min)	
Minimum allowable time from alarm to overflow	=	60 (sec)	
Required volume above overfill alarm set point	=	91.7 (bbl)	
Capacity to deck at CL (17'-8" ABL) =		5278 BBL	
Capacity to 7" below dk at CL (17'-1" ABL) =		5168 BBL	
Volume above alarm =		110.1 BBL	RESULT OK
**Recommended set point of	=	7 (inches)	[Based on 98% full tank]

**Note: Or 98.5%, whichever is lower (to comply with 33CFR155.775)	
Capacity at 98.5% =	5199 BBL
Dist from TT at CL =	0.49 ft.

Conrad C890 / Orange H407
Calculation of Overfill Alarm Set Point
(Cargo Tank No. 2 P/S)

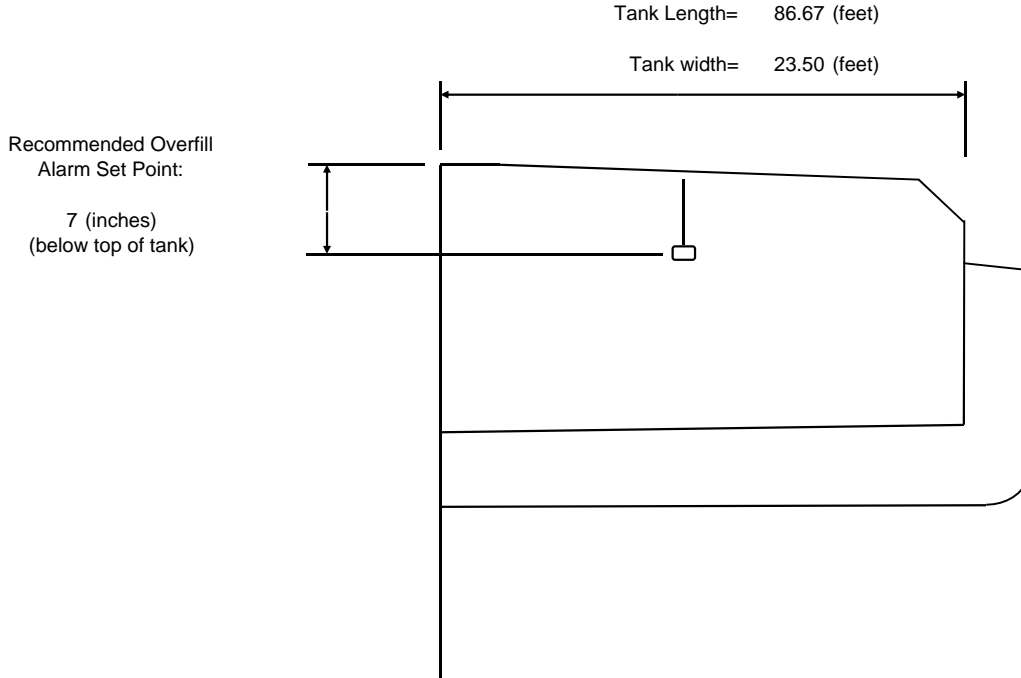

Maximum (per tank) Cargo Loading Rate	=	5,500 (bbl/hr)	
	=	91.67 (bbl/min)	
Minimum allowable time from alarm to overflow	=	60 (sec)	
Required volume above overfill alarm set point	=	91.7 (bbl)	
Capacity to deck at CL (17'-8" ABL) =		5258 BBL	
Capacity to 7" below dk at CL (17'-1" ABL) =		5149 BBL	
Volume above alarm =		109.6 BBL	RESULT OK
**Recommended set point of	=	7 (inches)	[Based on 98% full tank]

**Note: Or 98.5%, whichever is lower (to comply with 33CFR155.775)	
Capacity at 98.5% =	5179 BBL
Dist from TT at CL =	0.49 ft.

Conrad C890 / Orange H407
Calculation of Overfill Alarm Set Point
(Cargo Tank No. 3 P/S)

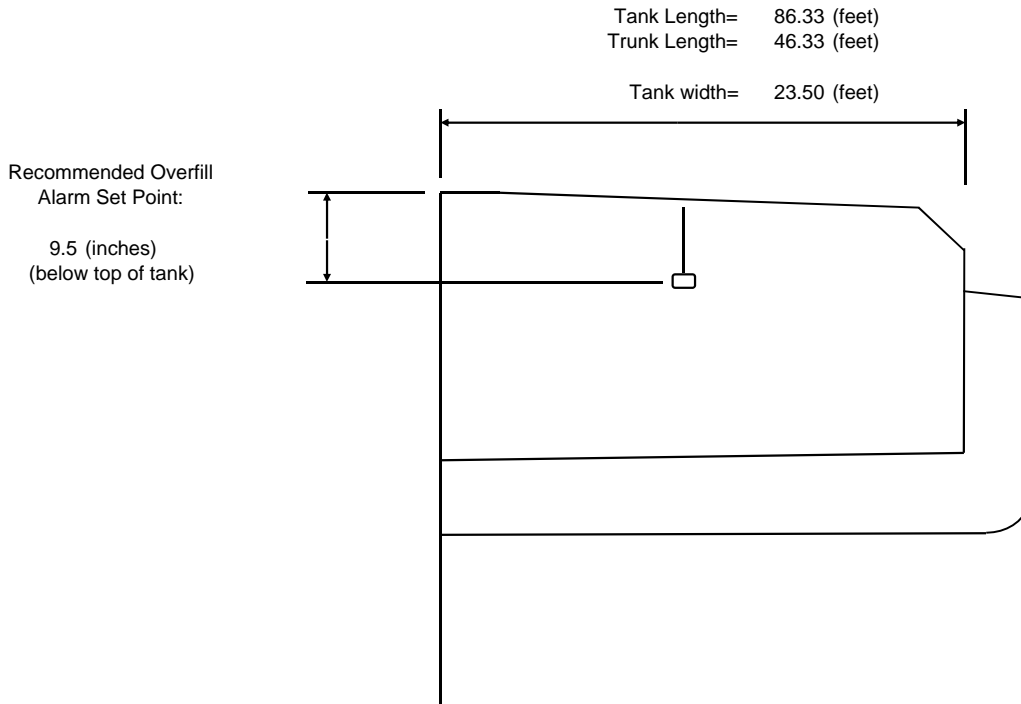

Maximum (per tank) Cargo Loading Rate	=	5,500 (bbl/hr)	
	=	91.67 (bbl/min)	
Minimum allowable time from alarm to overflow	=	60 (sec)	
Required volume above overfill alarm set point	=	91.7 (bbl)	
Capacity to deck at CL (17'-8" ABL) =		4409 BBL	
Capacity to 9.5" below dk at CL (16'-10.5" ABL) =		4314 BBL	
Volume above alarm =		95.1 BBL	RESULT OK
**Recommended set point of	=	9.5 (inches)	

**Note: Or 98.5%, whichever is lower (to comply with 33CFR155.775)	
Capacity at 98.5% =	4343 BBL
Dist from TT at CL =	0.63 ft.

REFERENCES

1. 46 CFR 32.55-25, Venting of cargo tanks of tank barges constructed on or after July 1, 1951 - B/ALL
2. 46 CFR 39.20-11, Vapor overpressure and vacuum protection - TB/ALL
3. 46 CFR 39.30-1, Operational Requirements - TB/ALL
4. Flow of Fluids Through Valves, Fittings, and Pipe; Crane Technical Paper No. 410
5. USCG Guidelines for Determining the Maximum Liquid Transfer Rate for a Tank Vessel Transferring a Flammable or Combustible Cargo Using a Vapor Control System
6. Conrad Dwg. 890-P3 Vapor Control Piping
7. USCG CHRIS (Chemical Hazards Response Information System) Manual.
8. 46 CFR 39.20-9, Tank Barge Liquid Overfill Protection - B/ALL
9. Cameron Hydraulic Data, 15th edition

LIST OF ATTACHMENTS

1. Flow Capacity Curves for High-Velocity P-V Valve
2. Vacuum flow diagram for High-Velocity P-V Valve

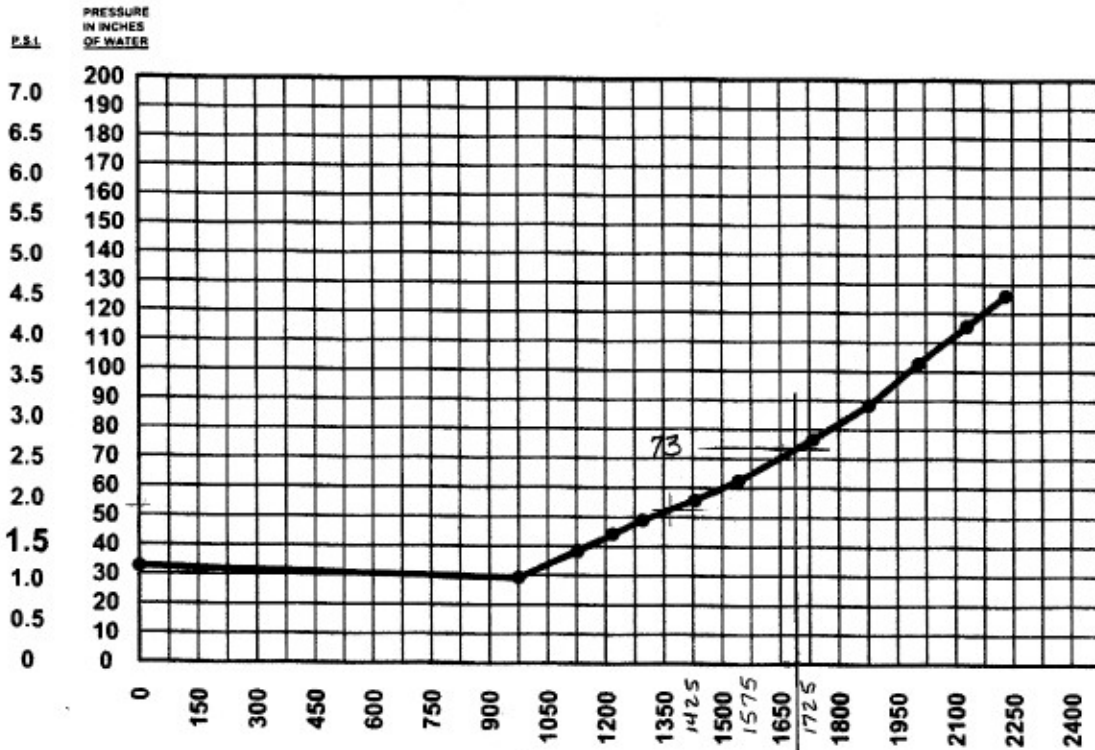

BARRELS PER HOUR	FLOW FT.³/MIN.	PRESSURE IN. OF H ₂ O
------------------	----------------	----------------------------------

10418	974	29.2
12064	1127	38.6
13017	1217	44.2
13882	1296	49.0
15296	1430	55.8
16483	1542	62.6
18547	1734	76.6
20086	1878	86.5
21435	2004	102.8
22783	2130	115.8
23882	2230	126.3

Curve for Pressure Side
 6" PV Valve - 1.5 PSI
 data based on air flow

$$18150 \text{ BBL/hr} \times \frac{42 \text{ gal}}{60 \text{ min}} \times \frac{\text{ft}^3}{7.48 \text{ gal}} = 1699 \text{ ft}^3/\text{min}$$

$$73 \text{ in H}_2\text{O} = \underline{\underline{2.64 \text{ psi}}}$$

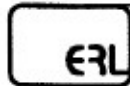

**ELECTROMECHANICAL
 RESEARCH LABORATORIES, INC.**

P.O. BOX 1088, NEW ALBANY, IN 47151

DATE
 5/5/03

DRAWN
 D. URBAN

PART NAME
 Flow Curve, 1.5 PSI, Pressure

TOLERANCE:
 0.0 = +/- 0.030
 0.00 = +/- 0.015
 0.000 = +/- 0.005

APPROVED

UNIT NAME
 Marine 6" PV (MD II)

SCALE

JOB NO.

DWG. NO.
 1250125B

ITEM NO.

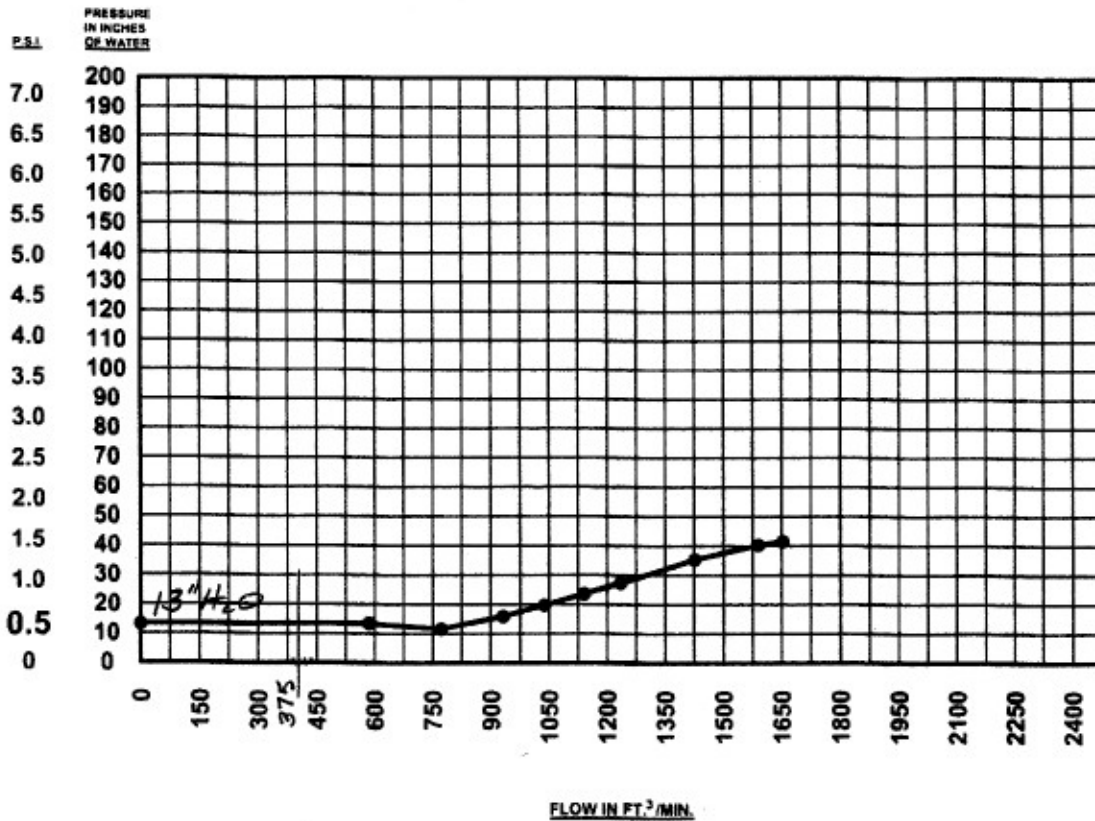

BARRELS PER HOUR	FLOW FT. ³ /MIN.	PRESSURE IN. OF H ₂ O
------------------	-----------------------------	----------------------------------

6260	585	13.6
8256	772	11.8
9958	931	16.0
11100	1038	19.9
12197	1141	23.7
13207	1235	27.5
15252	1426	35.5
17003	1590	40.4
17674	1653	41.7

Curve for Vacuum Side
6" PV Valve - 0.5 PSI
 data based on air flow

$$4300 \text{ bbl/hr} \times \frac{42 \text{ gal}}{\text{bbl}} \times \frac{\text{ft}^3}{7.48 \text{ gal}} \times \frac{\text{hr}}{60 \text{ min}} = 402 \text{ ft}^3/\text{min}$$

$$13 \text{ in H}_2\text{O} \times .03613 = 0.47 \text{ psi}$$



**ELECTROMECHANICAL
 RESEARCH LABORATORIES, INC.**

P.O. BOX 1026, NEW ALBANY, IN 47151

DATE 11/28/01

TOLERANCE:
 0.0 = +/- 0.030
 0.00 = +/- 0.015
 0.000 = +/- 0.005

DRAWN D. URBAN

APPROVED

SCALE

JOB NO.

PART NAME
 Flow Curve, 0.5 PSI, Vacuum

UNIT NAME
 Marine 6" PV (MD II)

DWG NO.
 332M075B

ITEM NO.



Marine Safety Center Vapor Control System (VCS) Plan Review Information Sheet (PRIS)



Vessel Name	NEW CONSTRUCTION	Shipyard	Conrad Industries
Official Number	CG1215009 & CG1215012	Hull Number	C-1005 & C-1006

1. This sheet consolidates critical VCS parameters for MSC Staff Engineers and CG Field Inspectors dealing with Vapor Control Systems. CG Inspectors should verify the vessel's VCS design is consistent with the information listed in boxes 2, 6, 7 & 8 prior to updating the vapor control endorsement on the vessel's Certificate of Inspection. For cases where the information in the VCS PRIS does not reflect the vessel's design the CG Inspector should contact the MSC's Cargo Authority branch.

2. Tank Maximum Design Working Pressure	<input type="text" value="3.00"/>	psig	Raised Trunk <input checked="" type="checkbox"/>	Flush Deck <input type="checkbox"/>
3. Authorized Maximum Cargo Transfer Rate(s)	<input type="text" value="5500"/>	bbl/hr loading (max 2 tanks simultaneously)		
	<input type="text" value="4300"/>	bbl/hr discharging		
4. Authorized Maximum Cargo Density	<input type="text" value="0.350"/>	lbm/ft ³		
5. Authorized VCS Categories	<input type="text" value="1 through 4"/>			

6. Cargoes with the highest vapor density and/or pressure drop:

a. Cargo Name

b. Cargo Name

7. Pressure Vacuum Valve:	8. VCS Pipe Sizes:																		
<table style="width: 100%;"> <tr> <td style="width: 30%;">Manufacturer</td> <td style="width: 30%;"><input type="text" value="ERL Superac"/></td> <td style="width: 20%;">Settings in psig:</td> <td style="width: 20%;"></td> </tr> <tr> <td>Size</td> <td><input type="text" value="6"/></td> <td>Pressure-side</td> <td><input type="text" value="1.5"/></td> </tr> <tr> <td>CG Approval</td> <td><input type="text" value="0"/></td> <td>Vacuum-side</td> <td><input type="text" value="0.5"/></td> </tr> </table>	Manufacturer	<input type="text" value="ERL Superac"/>	Settings in psig:		Size	<input type="text" value="6"/>	Pressure-side	<input type="text" value="1.5"/>	CG Approval	<input type="text" value="0"/>	Vacuum-side	<input type="text" value="0.5"/>	<table style="width: 100%;"> <tr> <td colspan="2">Approx. Inside Diameter</td> </tr> <tr> <td>Longitudinal Header (inches)</td> <td><input type="text" value="8"/></td> </tr> <tr> <td>Transverse Header (Inches)</td> <td><input type="text" value="8"/></td> </tr> </table>	Approx. Inside Diameter		Longitudinal Header (inches)	<input type="text" value="8"/>	Transverse Header (Inches)	<input type="text" value="8"/>
Manufacturer	<input type="text" value="ERL Superac"/>	Settings in psig:																	
Size	<input type="text" value="6"/>	Pressure-side	<input type="text" value="1.5"/>																
CG Approval	<input type="text" value="0"/>	Vacuum-side	<input type="text" value="0.5"/>																
Approx. Inside Diameter																			
Longitudinal Header (inches)	<input type="text" value="8"/>																		
Transverse Header (Inches)	<input type="text" value="8"/>																		
Required Venting Capacity of Pressure-Side of P/V valve	<input type="text" value="18000"/> bbl/hr (air)																		
Required Venting Capacity of Vacuum-Side of P/V valve	<input type="text" value="4300"/> bbl/hr (air)																		

9. Tank Overfill Protection System (check appropriate box or boxes)

a. High Level/Tank Overfill Alarm	<input checked="" type="checkbox"/>	Type	<input type="text" value="Verified by OCMI"/>
b. Overfill Control Shutdown	<input checked="" type="checkbox"/>	Type	<input type="text" value="Verified by OCMI"/>
c. Spill Valve	<input type="checkbox"/>	Type	<input type="text" value="N/A"/>
d. Rupture Disk	<input type="checkbox"/>	Type	<input type="text" value="N/A"/>

Meets ASTM F1271 Setting in psig

10. Closed Gauging Verify the vessel has closed gauging that satisfies 46 CFR 39.20-3 and 151.15-10(c).

11. Instructions/Guidelines for the OCMI:

11a. The following is the Marine Safety Center's recommended COI endorsement:

In accordance with 46 CFR Part 39, excluding part 39.40, this vessel's vapor collection system has been inspected to the plans approved by Marine Safety Center Letter Serial # C2-0902035 dated July 14, 2009 and extended by Serial # C1-1204485 dated October 24 2012, and has been found acceptable for the collection of bulk liquid cargo vapors annotated with "Yes" in the CAA's VCS column.

When the vessel is carrying cargoes containing greater than 0.5% benzene, the person in charge is responsible for ensuring the provisions of 46 US Code of Federal Regulations Part 197, Subpart C are applied.

11b. The MSC approval letter/s must be available at the OCMI's request.

11c. Verify isolation valve at the vapor connection flange is manually operable and designed in a way it is "clearly" open or closed.

11d. Previous applicable approval letters:

VCS Approval Letter MSC Plan Reviewer