

LEADER[®]

PUMPS



Technische data

Pomp:

Materiaal: hoogwaardig glasvezel versterkte kunststof
 Volledig corrosievaste materialen
 RVS as, kunststof waaier
 Mechanische asafdichting
 Max. vloeistoftemperatuur: 40 °C
 Beschermingsklasse: IP44
 Gewicht: ± 8,3 kg
 Aansluiting: 1" binnendraad

Motor:

Spanning: 230 v, 50 Hz
 Vermogen P1: 840 W
 Vermogen P2: 0,55 kW
 Maximale stroom: 3,8 A
 Toerental: 2.770 rpm
 Ingebouwde automatische thermische beveiliging



Afmeting

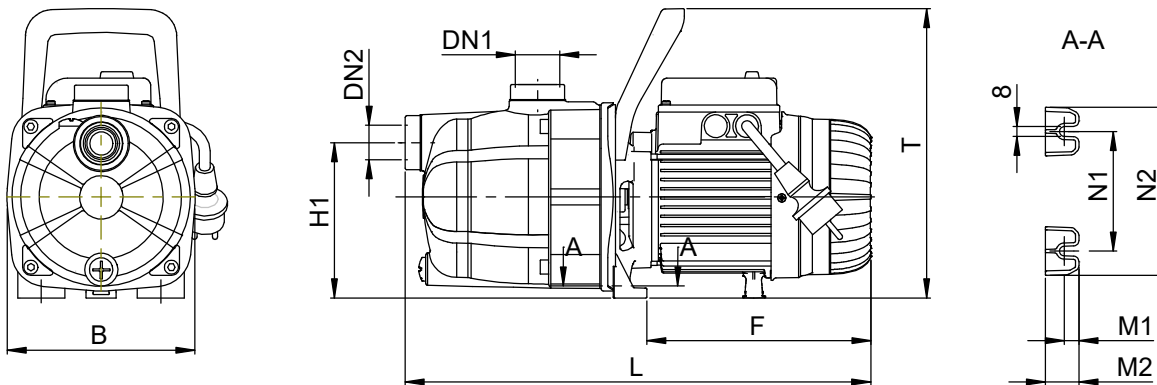

letter	A	B	DN1	DN2	F	H1	L	M1	M2	N1	N2	T	
mm	164	174,4	G 1"	G 1"	207,5	143,5	428	13,5	31	110,7	155,7	268	Ecojet 110+

Curve

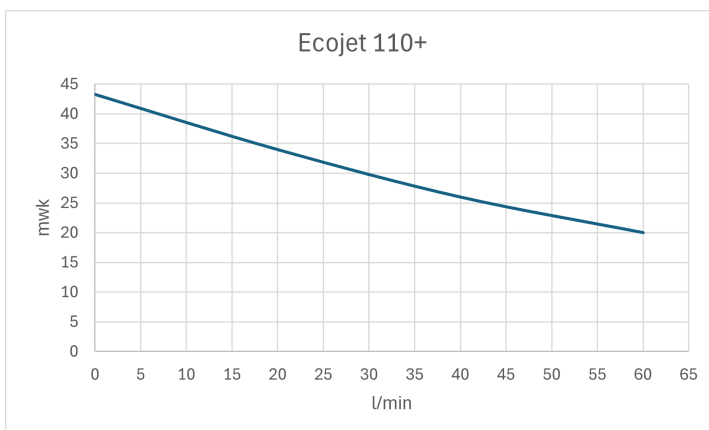

l/min	0	20	40	60
m ³ /h	0	1,2	2,4	3,6
Pomptype	opvoerhoogte in mwk			
Ecojet 110+	43,3	34	26	20

Artikelnummer:

PZL5002MP