

# yokowo



## FINE CONNECTOR

SPRING CONNECTOR™ TWO PIECE CONNECTORS LEAD SOCKET CONNECTORS



BREDI S.r.l.  
VIA DEI FALEGNAMI, 2 -  
41049 SASSUOLO (MO)

**BREDI**  
Electronic Components Source

APPROVED ✓ APPROVED ✓ APPROVED ✓

T: +39 0536 803561  
Email: [vendite@bredi.it](mailto:vendite@bredi.it)  
[www.bredi.it](http://www.bredi.it)

**HQ: YOKOWO CO.,LTD.**  
JR KANDA MANSEIBASHI BLDG. 14F,  
1-25, KANDASUDA-CHO, CHIYODA-KU  
TOKYO 101-0041, JAPAN  
<https://www.yokowoconnector.com/>

**YOKOWO EUROPE GmbH**  
**DÜSSELDORF OFFICE**  
LÜTTICHER STRASSE 132,  
40547 DÜSSELDORF, GERMANY

# SPRING CONNECTOR®

## ■ SPRING CONNECTOR® components

SPRING CONNECTOR® is composed of three parts : Pin, Tube and Spring

To meet customer specific requirements, connector features such as the length,diameter, shape, plating and current rating can easily be customized.

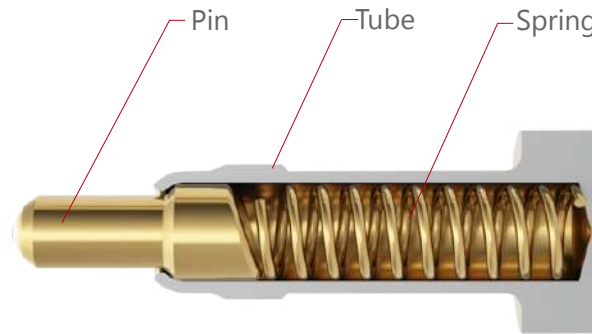

### Components

Pin: Brass with gold plating

Tube: Brass with gold plating

Spring: SUS/SWP

## ■ Applications and usage of the SPRING CONNECTOR®

The SPRING CONNECTOR® is suitable for device-internal connections as well as interface applications. The SPRING CONNECTOR® establishes a reliable signal and power transmission by effortlessly contacting the opposite side by either on a dedicated contact pad or simply on the board pattern. The SPRING CONNECTOR® can be utilized either as a single pin or in an array of multiple pins inserted in a connector housing. The housing geometry as well as the material are customizable. Various connector types for different mounting methods such as SMD or THT on PCB/FPC, cable soldering or crimping, and insert-molding/press-fit are available.



Interface connector / SMD



Multiple contacts



Insert molding/Press-fit



Internal connector /SMD



Cable termination



FPC assembly



# CORPORATE PROFILE

## ESTABLISHED

1922

## HEADQUARTERS

Tokyo, Japan

## CAPITAL

7,800 Million JPY

## PUBLICLY TRADED

Tokyo Stock Exchange Prime Market

## GLOBAL NETWORK

8 factories in Japan, USA, China, Malaysia and Vietnam  
Sales and R&D offices in Asia, Europe and Americas

## BUSINESS DOMAINS

Electronics: Device connectors  
Automotive: Car antennas  
Semiconductor: Probe cards

PRODUCTION, R&D AND SALES OFFICE LOCATIONS

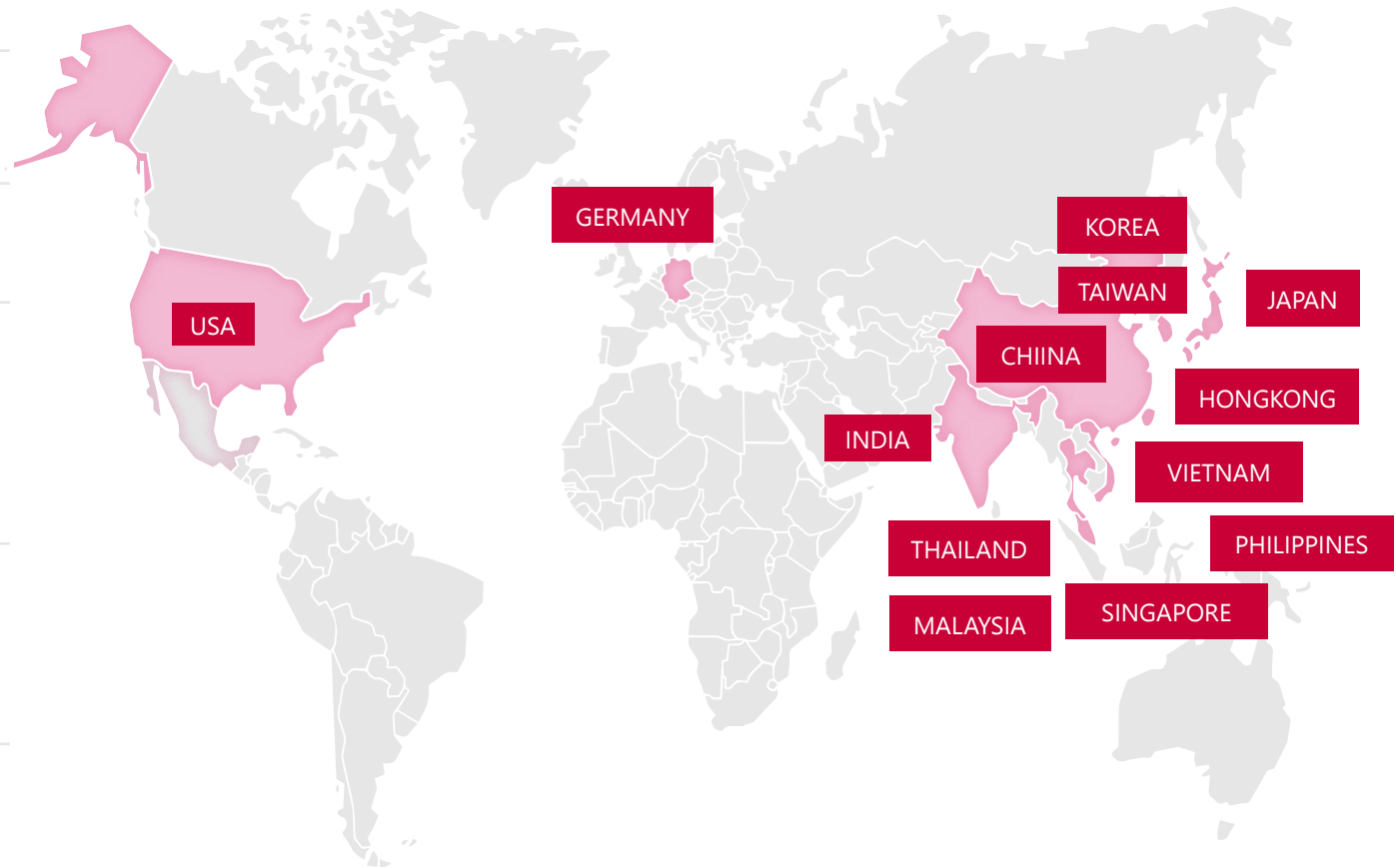

**8,304**  
Employees

**77,900**  
M JPY  
Turnover

# SPRING CONNECTOR® SOLDERING TYPE

## ■ Soldering and mounting methods (PCB/FPC, cables)

The SPRING CONNECTOR® is suitable for reflow soldering, wave soldering, manual soldering and cable soldering methods. The design and packaging of the connectors are adapted to the mounting and soldering process.

SMD  
(Soldering on PCB/FPC)



Through hole/Pin in paste  
(Soldering on PCB/FPC)



Solder-cup  
(Cable soldering)



## ■ Contact directions (Right angle contact)

Beside vertical soldering, right angle soldering is possible with the right angle type connectors from Yokowo's line-up including single contact and multiple contact connectors for SMD or THT mounting.

SMD/Single pin



SMD/Multiple contacts

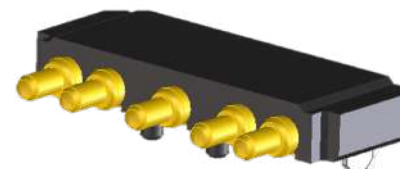

Through hole/  
Multiple contacts

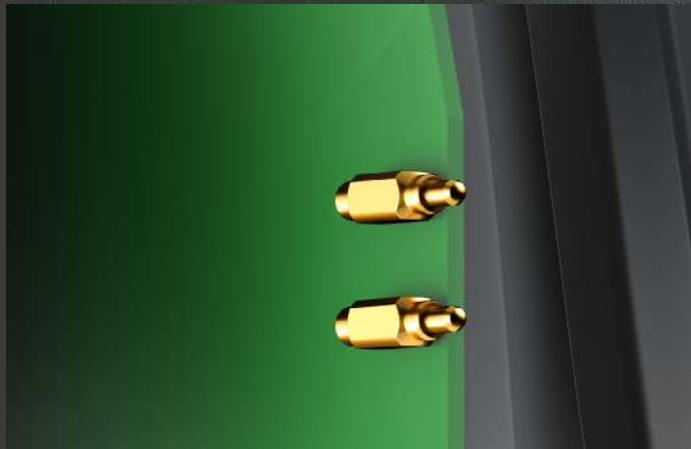
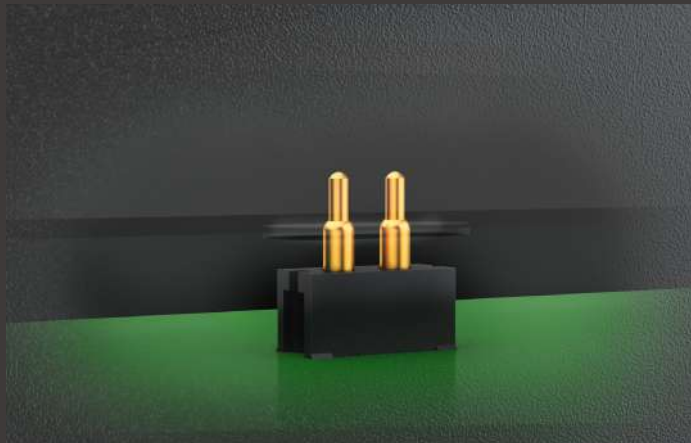

# SPRING CONNECTOR®

## ■ Standard structure, Current route

By adapting de-centred structures in the bias-cut pin type and hole-bored pin type, YOKOWO's SPRING CONNECTOR® drastically reduces the risk of contact loss between the pin and tube, enables a stable signal and power transmission.



### Bias-cut pin type

Application: Power/Signal

Rated current: 2A

Contact resistance: 50mΩ max

Working height: 2.4mm~

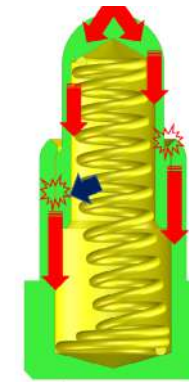
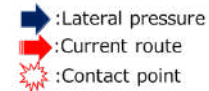

### Hole-bored pin type (De-centralized spring)

Application: Signal

Rated current: 0.5A

Contact resistance: 250mΩ max

Working height: 1.5mm~

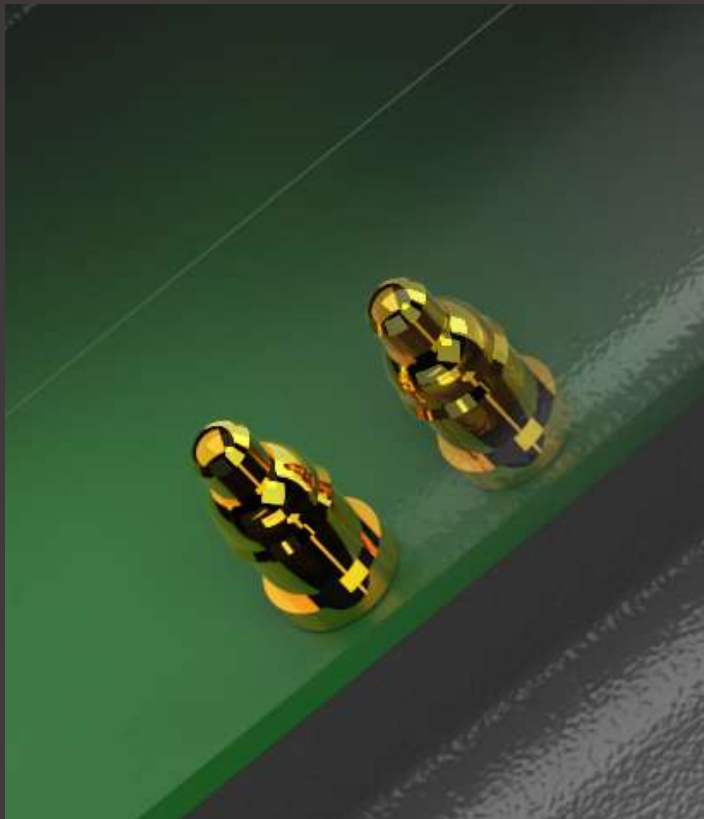
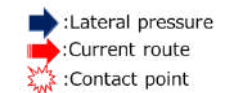

## ■ Performance (Spring force & Contact resistance)

Reliable performance and stable contact resistance due to the de-centered pin structure.

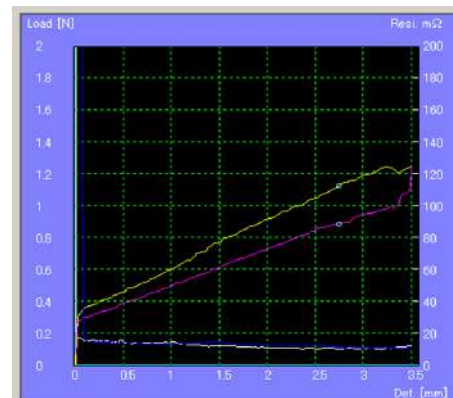

### Spring force

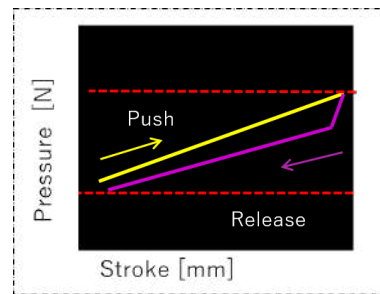

### Contact resistance

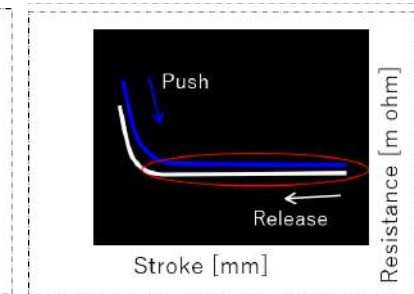

# SPRING CONNECTOR® USAGE OF FLOATING

## ■ Installation method



Press-fit into device's housing

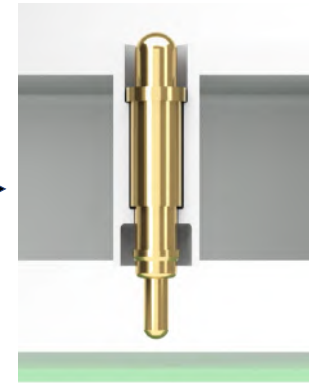

Compress between the contact surfaces

## ■ Floating function

### Clearance area

Due to the gap between housing and the SPRING CONNECTOR®, the SPRING CONNECTOR® moves up and down after press-fitting.

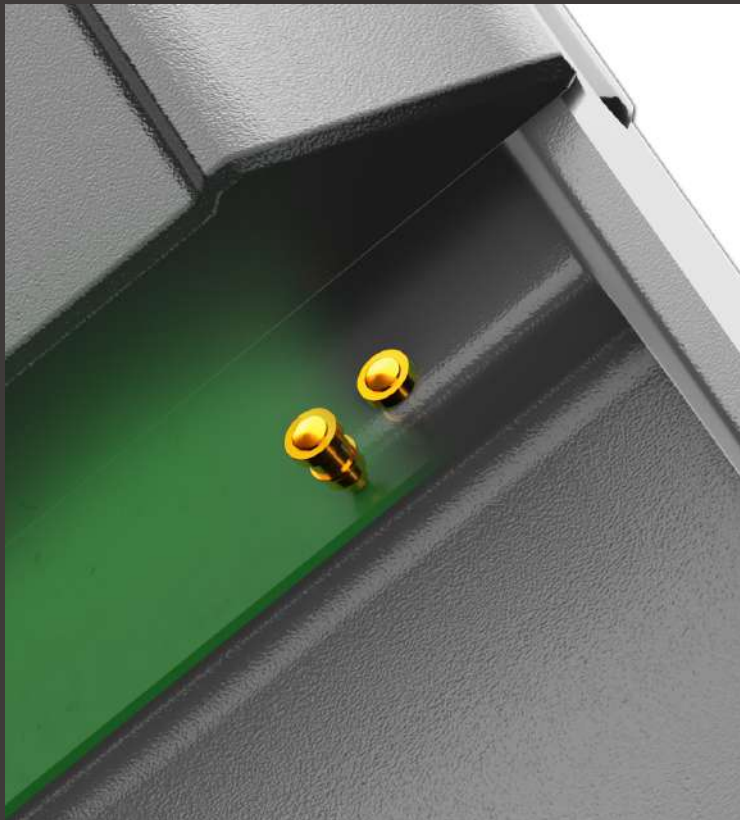
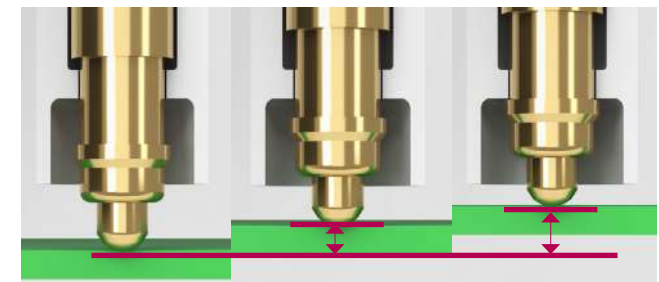

# SPRING CONNECTOR®

## ■ Insert molding, Press-fit type

Solderless SPRING CONNECTOR® types are available for insert molding and press-fit and are mostly used in interface applications combining the external contact pad and device-internal SPRING CONNECTOR® in one part. Equipped with O-rings, the press-fit type connectors are suitable for ingress protected devices up to IPX7.

Insert molding



Press-fit



## ■ Floating type (Similar to double sided SPRING CONNECTOR®)

Inserted in a device's internal structure with clearance between the structure and the SPRING CONNECTOR®, it floats between two contact surfaces such as PCBs.

Floating



# SPRING CONNECTOR® WATERPROOF

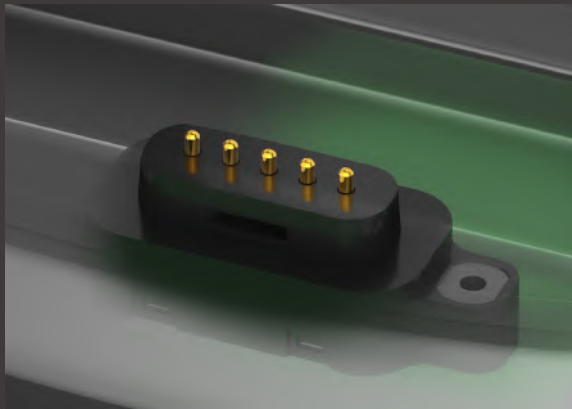

## ■ Female connector (IPX7 / Reflow soldering)

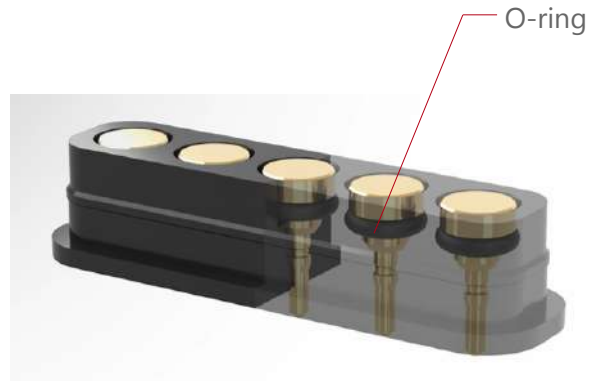

Waterproof rating: IPX7

Features: O-ring, potting with resin

Installation method: SMD (PiP) and reflow soldering

\* Dustproofing is also applicable depending on specs

## ■ Male connector (IPX7 / Screw lock)

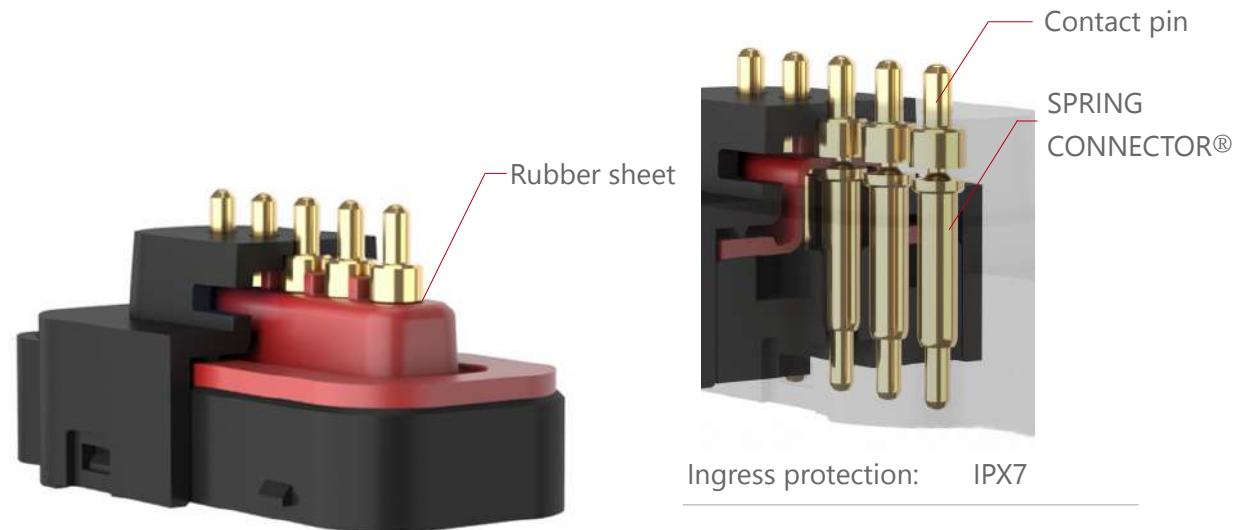

Ingress protection: IPX7

Features: Rubber sheet

Installation method: Screw lock

# SPRING CONNECTOR® MATING PAD

## ■ Female connectors for the SPRING CONNECTOR®

A variety of dedicated female connectors are available for interface applications. Matching designs of the two connector counterparts ensure a uniform design and perfect fit of the device and its counterpart such as a charging cradle. For ingress protection, IPX7 rated connectors are available.

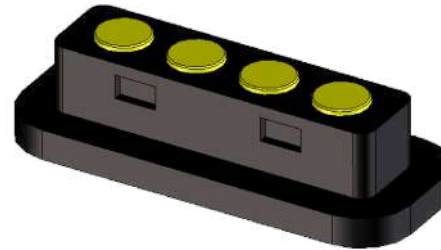

## ■ Soldering and mounting methods(PCB/FPC, Cables)

The female connectors are suitable for reflow soldering, wave soldering, manual soldering and cable soldering methods. The design and packaging of the connectors are adapted to the mounting and soldering process.



Soldered on PCB/  
SMD•Through hole



Soldered on FPC /  
SMD•Through hole



Soldered to cables



# SPRING CONNECTOR® HIGH SPEED

## ■ Electromagnetic field simulation

USB 3.1 Gen. 2 compliant high speed data transmission connectors are currently available from our catalogue line-up. Development time and prototyping costs of a custom high speed connector with customer's specific features such as housing geometry or pin arrangement is reduced by using our electromagnetic field simulation tool.

## ■ Example : Development of USB 3.1 Gen 2



### Step1

Male side

Female side

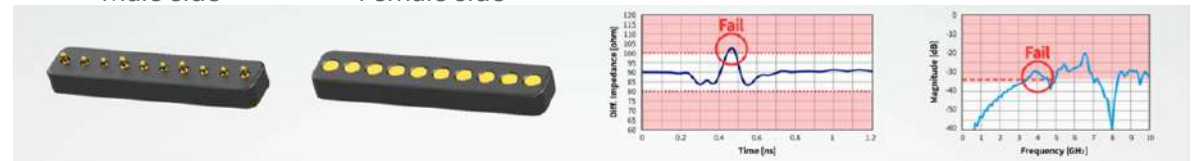

### Step2

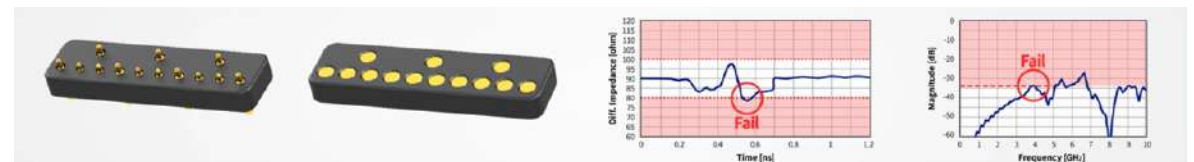

### Step3

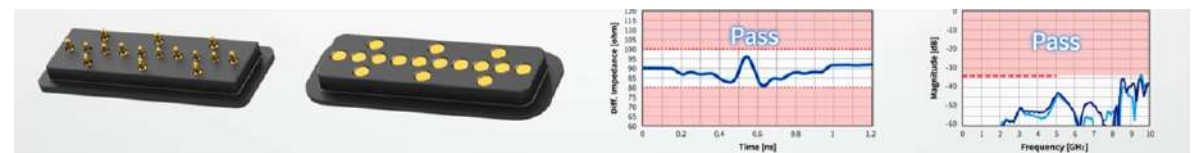

# SPRING CONNECTOR® HIGH CURRENT

## Internal structures

By incorporating additional contact elements and insulation inside of the connector, a high nominal current rating up to 10A per contact can be achieved for connectors in the catalogue line-up.



\* 15A is under development

## Current route



The unique internal structure reduces the contact resistance and protects the spring, allowing for a higher current rating with a maximum temperature rise of 30°C.



# TWO PIECE CONNECTORS

## ■ Installation examples



Soldered on PCB/  
Through hole



Soldered on PCB/  
SMD

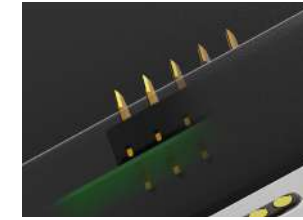

Soldered on PCB/  
Through hole

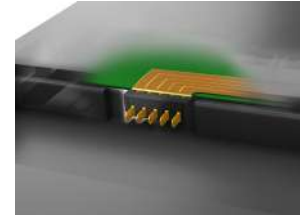

Soldered on FPC/  
SMD

## ■ Various connector layouts (e.g. battery usage)

With multiple mating orientation methods, the Two Piece Connectors allows for a high degree of design freedom.

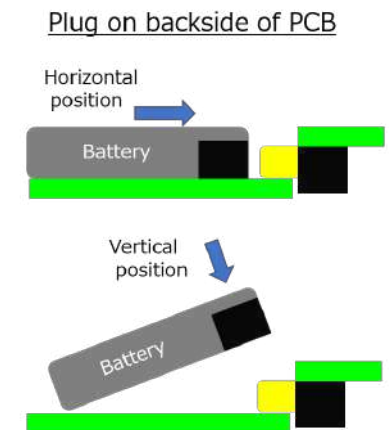
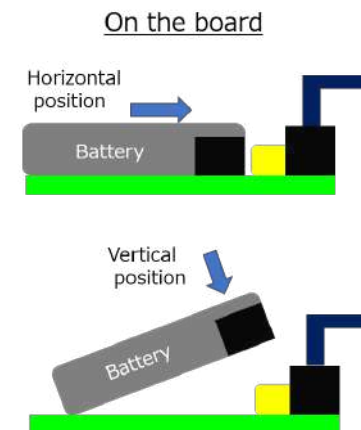
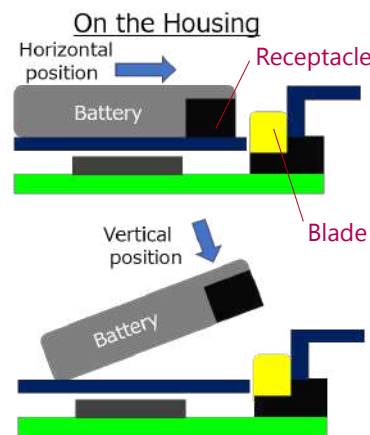

# TWO PIECE CONNECTORS

## ■ Specifications

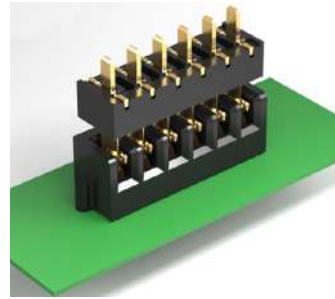

Vertical mating

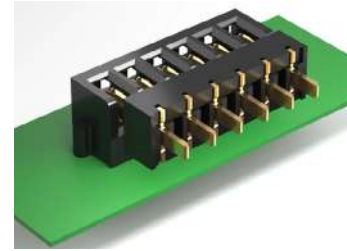

Right angle mating

Rated current:	1A - 3A
Contact resistance:	30 - 50mΩ max
Mating cycles:	2,000 cycles
Floating range	±0.3 - 0.5mm

## ■ Floating function

Floating range ( $\pm 0.5/\pm 0.3$ )

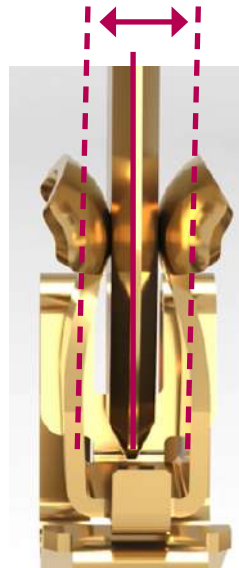

The spring follows the movements of the plug and retains contact

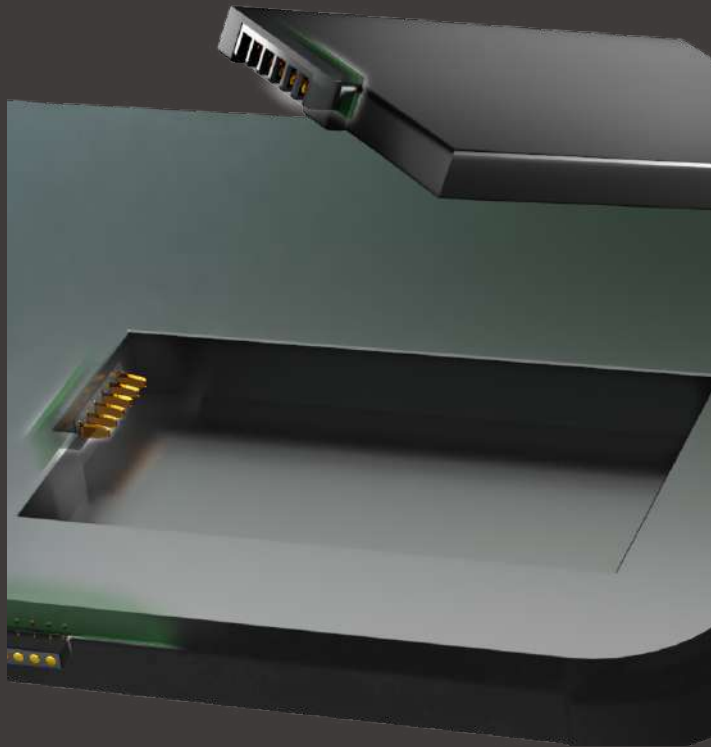
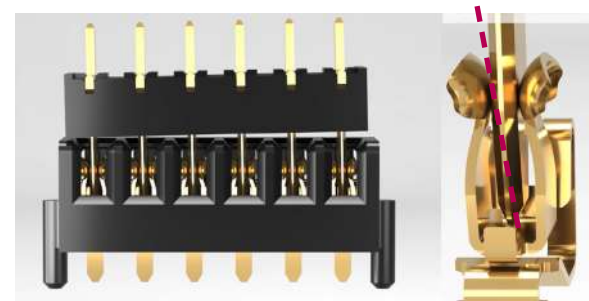
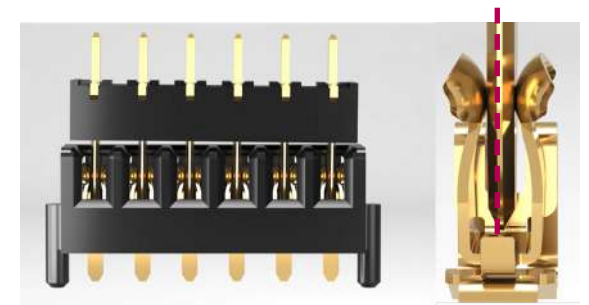

# APPLICATION EXAMPLES

## Rugged Tablet PC

### Device body and cradle



#### 1 Mating pad connector



- Mating pad connector for power and data transmission
- Integrated O-rings for IPX7 ingress protection
- Suitable for high speed data transmission

#### 2 SPRING CONNECTOR™



- For PWR and data transmission
- SMT, THT or solderless
- High cycle durability (100,000~)
- Integrated O-rings or rubber sheet for IPX7 ingress protection
- Suitable for high speed data transmission
- Contact sequencing

### Battery

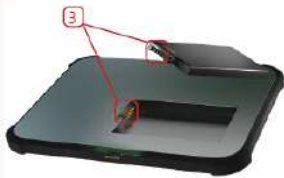

#### 3 Two Piece connector



- High shock and vibration resistance
- 6-axis misalignment compensation
- SMT/THT, vertical or horizontal

## Smart Glasses

### Device body



#### 1 SPRING CONNECTOR™ w. integrated waterproof contact pad

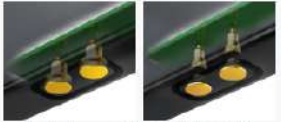

- The bottom of the SPRING CONNECTOR™ is used as a mating pad
- Press-fit or insert molding integration
- Option with integrated O-ring for IPX7 ingress protection
- Silver color plating option

#### 1 Waterproof mating pad connector

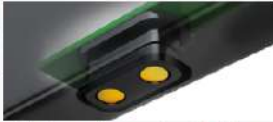

- Mating pad connector with integrated O-rings for IPX7 ingress protection
- Suitable for SMT and reflow

### Charging cradle or charger



#### 2 Lead socket connectors



- Battery pack connection
- Easy wiring with AWG#24-22 without hand soldering
- Suitable for SMT and reflow

#### 4 SPRING CONNECTOR™



- Charger pins
- Wire termination (solder cup)

#### 3 SPRING CONNECTOR™



- Charger pins
- SMT, THT or solderless type
- Single pin or incl. housing

## Bluetooth Earphones

### Charging cradle



#### 1 SPRING CONNECTOR™



- Charger pins
- SMT or solderless type
- Crown cut contacts optional

#### 2 Lead socket connectors



- Battery pack connection
- Easy wiring with AWG#24-22
- Suitable for SMT and reflow

### Earbuds



#### 3 SPRING CONNECTOR™ with integrated contact pad

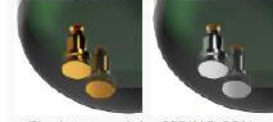

- The bottom of the SPRING CONNECTOR™ is used as a mating pad
- Press-fit or insert molding integration
- Silver color plating option

#### 3 SPRING CONNECTOR™ and separated contact pads



- SPRING CONNECTOR™ and separated mating pad
- Mating pad integrated by insert molding
- Low profile SPRING CONNECTOR™ connects mating pad and PCB

#### 4 SPRING CONNECTOR™ (vertical or horizontal mount)

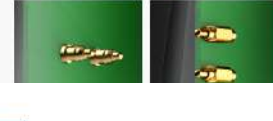

- SPRING CONNECTOR™ in board to bluetooth antenna, touch panel, button or sub-board
- Vertical or horizontal (right-angle) mount

## ADAS / Vision

### Camera



#### 1 SPRING CONNECTOR™

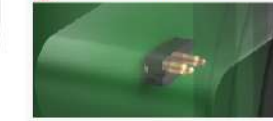

- PCB-PCB, anti-fog heater connection
- Direct contact to land pattern on PCB without receptacle
- SMT or THT

#### 2 Coaxial SPRING CONNECTOR™

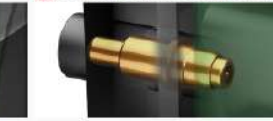

- Coaxial structure with integrated shielding
- Direct contact to land pattern on PCB without receptacle
- Fakra connector can be attached to the backside of the spring connector

## Mirrors

### Interior mirror



#### 1 SPRING CONNECTOR™

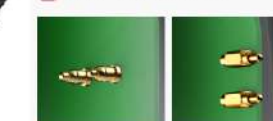

- PCB-PCB, GND, antenna, auto dimming module connection
- Direct contact to land pattern on PCB without receptacle
- SMT or THT
- Right-angle soldering option

#### 1 Solderless SPRING CONNECTOR™



- Solderless and easy integration by press-fitting the device housing
- PCB-PCB, GND, antenna

# SPRING CONNECTOR® WATERPROOF

## ■ Specifications

Ingress protection:	IPX7
Rated current:	3A
Contact resistance:	30mΩ max
Mating cycles:	2,000 cycles
Floating range	±0.3mm



Plug side



Receptacle side

## ■ Waterproof Structure

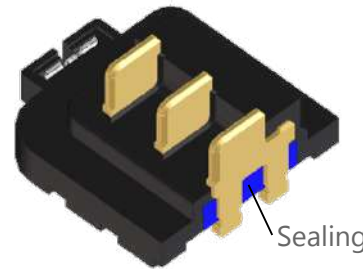

Sealing

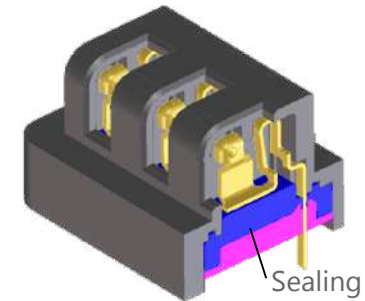

Sealing

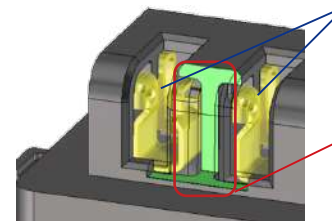

Isolated contact area

The contacts are isolated to prevent short circuit between adjacent contacts

Partition wall

Insulation between adjacent contacts



# APPLICATION EXAMPLES

## Manipulator, Robot Arm

### End effector, tool



**1 SPRING CONNECTOR™**

- SPRING CONNECTOR™
- High mating tolerance compensation
- High shock and vibration resistance
- High cycle durability (~100,000)
- SMT, THT or cable wiring

**2 Mating pad connector**

- Mating pad connector
- SMT, THT or cable wiring

## Warehouse Robot

### Device body



**1 Mating pad connector**

- Mating pad connector for power and data transmission
- Integrated O-rings for ingress protection
- SMT, THT or cable wiring

**2 Mating pad (sliding type)**

- Mating pad connector for high current power transmission
- Sliding mating with leaf spring connectors
- SMT or THT

### Dock, charger



**3 SPRING CONNECTOR™**

- SPRING CONNECTOR™ for power and data transmission
- High current capability
- High cycle durability (~100,000)
- SMT, THT or cable wiring

**4 Leaf spring connector**

- Leaf spring connector for high current power transmission
- High mating tolerance compensation
- SMT or THT

## DSLM, Surveillance Cam

### Lens mount



**1 Lens mount connector**

- Signal and current transmission between camera body and interchangeable lens
- Connector assembly incl. FPC
- Robust SPRING CONNECTOR™ design, suitable for sliding mating (rotational movement)
- Contact sequencing

## DSLM, Surveillance Cam

### Lens mount



**1 Lens mount connector**

- Signal and current transmission between camera body and interchangeable lens
- Connector assembly incl. FPC
- Robust SPRING CONNECTOR™ design, suitable for sliding mating (rotational movement)
- Contact sequencing

### Battery



**3 Two Piece connector**

- High shock and vibration resistance
- 6-axis misalignment compensation
- SMT/THT, vertical or horizontal

# APPLICATION EXAMPLES

## Thermostat

### ■ Device body and base

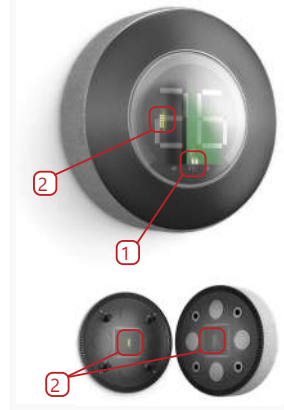

#### ① Lead socket connectors



- PCB to PCB, module or power source
- Easy wiring with AWG#24-22 without hand soldering
- Suitable for SMT and reflow
- Wire is detachable and reattachable

#### ② SPRING CONNECTOR™ and pad

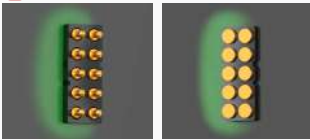

- SPRING CONNECTOR™ and dedicated mating pad connector
- PCB to PCB connection
- Power and signal transmission
- Multi-pin connectors

## Handheld Computer

### ■ Device body



#### ① Mating pad connector



- Mating pad connector for power and data transmission
- Integrated O-rings for IPX7 ingress protection
- Suitable for high speed data transmission

#### ② SPRING CONNECTOR™ (vertical or horizontal mount)

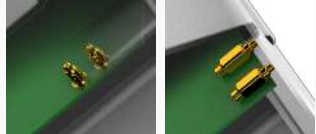

- PCB-GND, antenna, wireless charging module
- SMT or THT
- Right-angle soldering option

#### ② Solderless SPRING CONNECTOR™



- Solderless integration by press-fitting
- Easy assembly by press-fitting into the device housing
- PCB-GND, antenna, wireless charging module

### ■ Charging cradle and battery



#### ③ SPRING CONNECTOR™



- For PWR and data transmission
- SMT or THT
- High cycle durability (100,000~)

#### ④ Two Piece connector



- High shock and vibration resistance
- 6-axis misalignment compensation
- SMT/THT, vertical or horizontal

## Drone

### ■ Device body and dock



#### ① SPRING CONNECTOR™



- For power and data transmission
- High current capability
- High cycle durability (~100,000)
- SMT, THT or cable wiring



- Integrated rubber sheet for IPX7 ingress protection
- Solderless integration (screw lock)

#### ② Mating pad connector

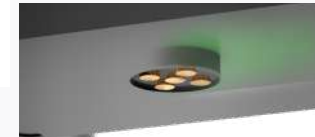

- SMT, THT or cable wiring
- Integrated O-rings or rubber sheet for IPX7 ingress protection

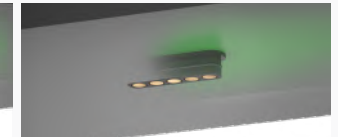

- Integrated O-rings for IPX7 ingress protection
- Suitable for SMT and reflow

### ■ Camera



#### ④ SPRING CONNECTOR™



- Anti-fog heater
- Suitable for SMT and reflow or THT

### ■ Battery

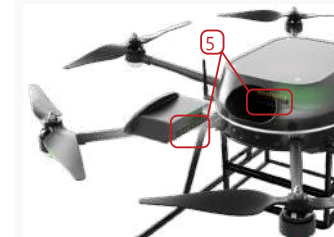

#### ⑤ Two Piece connector

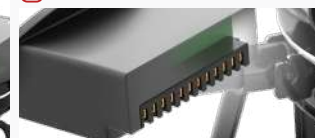

- High shock and vibration resistance
- 6-axis misalignment compensation
- SMT/THT, vertical or horizontal

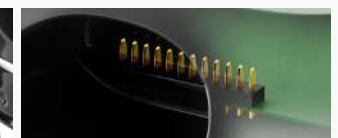

### ■ Rotor arm



#### ③ Two Piece connector



- High shock and vibration resistance
- 6-axis misalignment compensation
- SMT/THT, vertical or horizontal



# CATALOGUE SPRING CONNECTOR™







## ■ SPRING CONNECTOR™ Special Specs

Category		Appearance	Number of contacts/unit	Soldering/Installation method	Working Height	Pin pitch	Pin Assignment	Current Rating	Contact Resistance	Spring Force	Cycle Durability	Packaging	Operational Temp. Range	
SPRING CONNECTOR™	Small Space	Low Profile Series		1	SMD	1.5~2.55mm	-	-	0.5A	250mΩ max	0.4 - 0.6N	20,000	Tape & Reel	-40 - +85°C
		2.0mm Small pitch Series		2~4	SMD	3.3 - 6.15mm	2.0mm	Single Row	1A	50mΩ max	1.0N	20,000	Tape & Reel	-40 - +85°C
	Low Spring Force	Low Spring Force Series		1	SMD	2 - 3.8mm	-	-	0.5A	200mΩ max	0.3N	20,000	Tape & Reel	-40 - +85°C
				2~10	SMD	4.7 - 8.25mm	2.5mm	Single Row	0.5A	200mΩ max	0.3N	20,000	Tape & Reel	-40 - +85°C
	Right Angle Contact	Single Pin Series		1	SMD	-	-	-	2A	50mΩ max	0.65N	20,000	Tape & Reel	-40 - +85°C
		Multiple Pin Series		2~5	SMD	-	-	Single Row	2A	50mΩ max	-	20,000	Tape & Reel	-40 - +85°C
	Press-fit Installation	Floating Series		1	Built-in	2.05~13.5mm	-	-	0.5A,2A	50mΩ~100mΩ max	0.4 - 1.1N	5,000	Plastic bag	-40 - +85°C

# CATALOGUE SPRING CONNECTOR™





## ■ SPRING CONNECTOR™ Standard Specs

Category		Appearance	Number of contacts/unit	Soldering/Installation method	Working Height	Pin pitch	Pin Assignment	Current Rating	Contact Resistance/max value	Packaging	Operational Temp. Range
SPRING CONNECTOR™	Standard Specs	Single pin SMD Series 	1	SMD	2.4 - 8.75mm	-	-	2A	50mΩ	Tape & Reel	-40 - +85°C
		Single pin THT Series 	1	DIP	2.4 - 8.75mm	-	-	2A	50mΩ	Tape & Reel	-40 - +85°C
		Multiple pin Single row Series 	2 - 9	SMD	2.4 - 6.35mm	2.5/3.0mm	Single Row	2A	50mΩ	Tape & Reel	-40 - +85°C
		Multiple pin Double row Series 	6 - 20	SMD	4.3 - 6.35mm	2.5mm	Double Row	2A	50mΩ	Tape & Reel	-40 - +85°C
		2.54mm pitch SMT Series 	10	SMD	4.3 - 6.35mm	2.54mm	Single Row	2A	50mΩ	Tape & Reel	-40 - +85°C
				40	SMD	4.3 - 6.35mm	2.54mm	Double Row	1A	50mΩ	Plastic bag
		2.54mm pitch THT Series 	10	DIP	4.6 - 5.1mm 6.6 - 7.5mm 7.6 - 8.75mm	2.54mm	Single Row	2A	50mΩ	Plastic bag	-40 - +85°C

# CATALOGUE SPRING CONNECTOR™



## ■ SPRING CONNECTOR™ Special Specs

Category		Appearance	Number of contacts/unit	Soldering/Installation method	Working Height	Pin pitch	Pin Assignment	Current Rating	Contact Resistance	Spring Force	Cycle Durability	Packaging	Operational Temp. Range
SPRING CONNECTOR™	USB Signal Transmission	 USB2.0	4	SMD	2.4~6.35mm	2.5mm	Single Row	2A	50mΩ max	0.9~1.-8N	20,000	Tape & Reel	-40 - +85°C
		 USB3.1 Gen.2	16	DIP	4.7mm	4.7mm	Double Row	1A/2A	50mΩ max	0.8N	20,000	Tray Packaging	-40 - +85°C

# CATALOGUE SPRING CONNECTOR™





## ■ SPRING CONNECTOR™ Special Specs

Category		Appearance	Number of contacts/unit	Soldering/Installation method	Working Height	Pin pitch	Pin Assignment	Current Rating	Contact Resistance	Spring Force	Cycle Durability	Packaging	Operational Temp. Range	
SPRING CONNECTOR™	Waterproof, Robustness	IPX7 Wataproof		5	Screw Lock	9.3mm	2.5mm	Single Row	2A	50mΩ	0.8N	20,000	Tape & Reel	-40~+85°C
		100K High Durability Series		1	SMD	3.7~8.75mm	-	-	2A	50mΩ	1.0N	100,000	Tape & Reel	-40~+85°C
		Abrasion Resistance with PdNi plating		1	SMD	2.4~8.75mm	-	-	2A	50mΩ	0.9~1.08N	20,000	Tape & Reel	-40~+85°C
		125°C High Temperature		1	SMD	4.7~5.95mm	-	-	2A	50mΩ	1.0N	20,000	Tape & Reel	-40~+125°C
	High Current	5A THT		1	DIP	5.6~6.25mm	-	-	5A	50mΩ	1.0N	5,000	Plastic Bag	-40~+85°C
		5A cable Soldering		1	Cable Attachment/Solder-cup	5.6~6.25mm	-	-	5A	50mΩ	1.0N	5,000	Plastic Bag	-40~+85°C
		5A Cable Crimping		1	Cable Attachment/Crimping	9.8~10.55mm 10.8~11.45mm 15.6~16.3mm	-	-	5A	50mΩ	1.0N	5,000	Plastic Bag	-40~+85°C
		10A THT		1	DIP	6.1~6.8mm	-	-	10A	50mΩ	1.28N	20,000	Plastic Bag	-40~+85°C

# CATALOGUE TWO PIECE CONNECTORS









## Two Piece Connectors

Category	Appearance	Number of contacts/unit	Soldering/Installation method	Pin pitch	Floating Range	Current Rating	Contact Resistance	Cycle Durability	Packaging	Operational Temp. Range	
Two Piece Connector	3.0mm pitch Standard Type		3~6	DIP	3.0mm	+/-0.5mm	3A	30mΩ max	2,000	Tray	-40 - +85℃
	2.5mm Compact Type		5	SMD	2.5mm	+/-0.3mm	1A	30mΩ max	2,000	Tray	-40 - +85℃
	IPX7 Waterproof		5	SMD	3.0mm	+/-0.3mm	3A	30mΩ max	2,000	Tray	-40 - +85℃

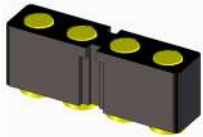
# CATALOGUE SPRING CONNECTOR™

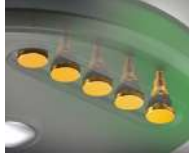

## ■ Mating Pad

Category		Appearance	Number of contacts/unit	Soldering/Installation method	Working Height	Pin pitch	Pin Assignment	Current Rating	Contact Resistance	Packaging	Operational Temp. Range
SPRING CONNECTOR™	Standard	2Pin~9Pin SMT Series 	2~9	SMD	-	2.5mm	Single Row	2A	50mΩ	Tape & Reel	-40~+85℃
		6Pin~20Pin SMT Series 	6~20	SMD	-	2.5mm	Double Row	2A	50mΩ	Tape & Reel	-40~+85℃
		10Pin 2.54mm Pitch THT Series 	10	DIP	-	2.54mm	Single Row	2A	50mΩ	Tape & Reel	-40~+125℃
	Press-fit Installation	Mating Pad with SPRING CONNECTOR™ 	1	Built-in	2.4~4.65mm	-	-	2A	50mΩ	Plastic Bag	-40~+85℃
	Waterproof	IPX7 Mating Pad with SPRING CONNECTOR™ 	1	Built-in	-	-	-	2A	50mΩ	Plastic Bag	-40~+85℃
IPX7 2Pin~10Pin SMT Series 		2~10	SMD	-	2.5mm, 2.54mm(10pin) Type	-	2A	50mΩ	Plastic Bag	-40~+85℃	

# *yokowo*

**HQ: YOKOWO CO.,LTD.**

JR KANDA MANSEIBASHI BLDG. 14F,  
1-25, KANDASUDA-CHO, CHIYODA-KU  
TOKYO 101-0041, JAPAN  
<https://www.yokowoconnector.com/>

**YOKOWO EUROPE GmbH**

**DÜSSELDORF OFFICE**  
LÜTTICHER STRASSE 132,  
40547 DÜSSELDORF, GERMANY

**COMPANY  
PROFILE**



**INQUIRY**



**SAMPLE  
REQUEST**



 **BREDI**  
Electronic Components Source