

K←SERIES

ACRYLIC BASES

K-UT09-6036

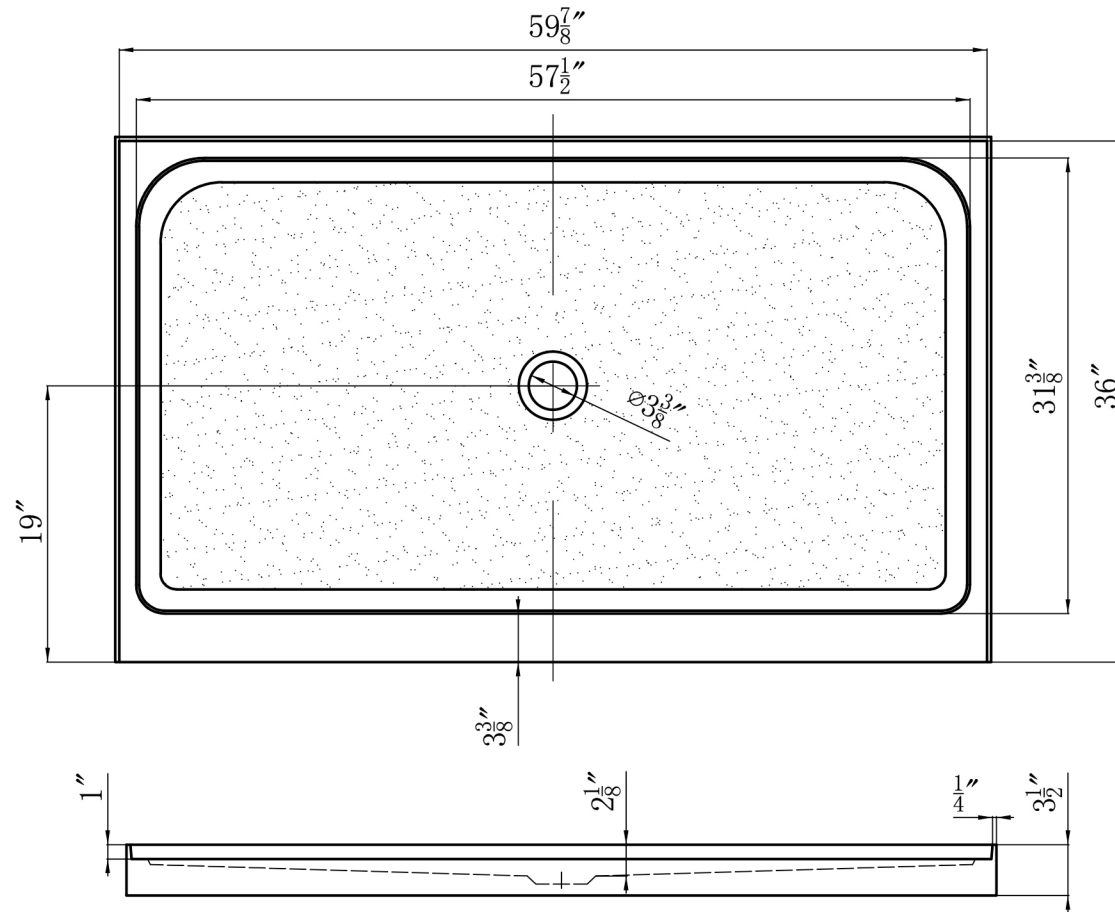

Size tolerance $\pm 5\text{mm}$