

K-SERIES

ACRYLIC BASES

K-UT09-4836

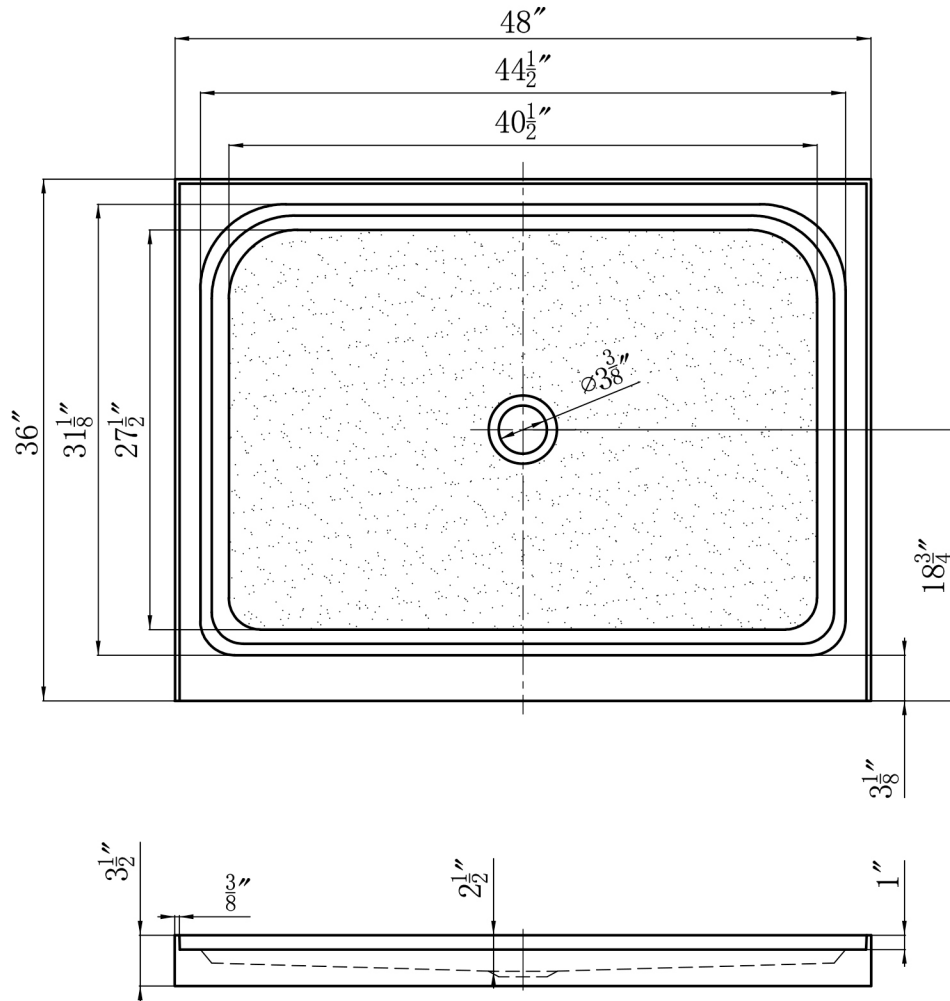

Size tolerance $\pm 5\text{mm}$