

POWERTRON[®]



**OWNER'S MANUAL FOR:
Tap Box Quick Connect**

CONTRACTOR SERIES

- **100 Amp**
- **200 Amp**
- **400 Amp**
- **600 Amp**
- **800 Amp**

POWERTRON CORP.
P.O. Box 160
Nokomis, Illinois, 62075
800.221.7665
www.powertronsolutions.com





OWNER'S MANUAL FOR: *Tap Box Quick Connect*

CONTRACTOR SERIES

- **100 Amp**
- **200 Amp**
- **400 Amp**
- **600 Amp**
- **800 Amp**

We're committed to providing premier products that are easy to install and safe to operate. To help ensure the longevity and performance of your Powertron® Tap Box, refer to this Owner's Manual and by contacting us at 800-221-7665 for any additional questions.

Your General Tap Box Information:

Product Label Apply Here

UL Listing Information

cULus 1008 Listed

Control #: 47HY

Product ID: Enclosed Power Inlet

General Installation Information:

Date of Installation: _____

Installed By: _____

Company Name: _____

Company Phone #: _____

Company Website: _____

Safety Information and Definition

In this manual and in labels located on the Powertron® Tap Box the Safety Signal Words and the Safety Alert Symbol are defined by:

• Safety Signal Words

DANGER: means if the safety information is not followed someone will be seriously injured or killed.

WARNING: means if the safety information is not followed someone could be seriously injured or killed.

CAUTION: means if the safety information is not followed someone may be injured.

• Safety Alert Symbol

This symbol () indicates a potential personal injury hazard and is used to identify safety messages.



All wiring must be made in accordance with the National Electric Code (NEC) and local building codes.



Powertron® Tap Boxes are not intended for use in Emergency Systems as defined by NFPA/NEC Chapter 7, Article 700. Emergency Systems have special requirements as Specified by law.



Refer to the connection diagrams in the electrical connection section of this manual to confirm you have the correct model for this installation.

Table of Contents

Unit & Shipping Weight	page 1
General Safety Information	page 1
Definitions	page 2
Installation	page 3
Considerations when Locating your Powertron® Tap Box	page 4
Connecting your Tap Box to Building	page 5
Electrical Connections to Building	page 6
Tap Box Components & Parts	page 7
Maintenance and Post Installation Check List	page 8
Electrical Connections to Generator	page 9
Connecting the Generator to the Tap Box.....	page 10
Maintenance and Service of Powertron® Tap Box.....	page 11
Powertron® Exclusive Limited Warranty	page 12

Unit & Shipping Weight

	Unit Weight		Approx. Shipping Weight (Skid, Packaging, etc.)	
	Mild Steel Enclosure	Stainless Steel Enclosure	Mild Steel Enclosure	Stainless Steel Enclosure
100A to 400A	80 lbs.	80 lbs.	130 lbs.	130 lbs.
600A to 800A	85 lbs.	85 lbs.	135 lbs.	135 lbs.

General Safety Information

Within the material provided by Powertron® Corp., you shall find separate manuals (i.e. Hubbell single pole receptacles, Hoffman enclosure, etc.) of key components used in the Powertron® tap box. Read all component literature before installing the Powertron® Tap Box. Save the information for future reference. In addition to following instructions and warnings provided for the Powertron® Tap Box, also follow proper lockout/tagout procedures and what is supplied in the component manufacturers' information:



Danger: Hazard of Electric Shock, Arc Flash, or Explosion

- Hazardous voltages exist inside the Powertron® Tap Box. Before opening the barrier wall cover, make sure the generator cables are disconnected and the GFCI supply circuit has been de-energized and locked out at its breaker.
- Wear appropriate personal protective equipment (PPE) and follow safe electrical work practices per NFPA 70E.
- Connection of the Powertron® Tap Box to a building's electrical system must be carried out by a qualified person. Connection of a generator to the Powertron® Tap Box must also be made by a qualified person.
- The Powertron® Tap Box does not provide over current or fault protection to the electrical system. The generator must provide fault current protection through the Tap Box, through the transfer switch and up to the building's distribution panel connections.
- The Powertron® Tap Box does not provide phase synchronization or matching. It is critical that the Powertron® Tap Box's is marked with the correct phase rotation for its connection to the building's wiring. When a generator is connected, its phase rotation must match what is marked on the Powertron® Tap Box. See *Electrical Connections to Building* section.
- To operate safely the Powertron® Tap Box must be maintained periodically. Refer to the Maintenance section of this manual for more information including the maintenance checklist.
- To prevent overheating of the electric cable connections inside the Powertron® Tap Box they must be free of corrosion and the cable lug bolts must be fully tightened to the lug manufacturer's specifications. The bolt torque required for the connectors to the copper bus bar or power distribution block is listed on the label located inside the Powertron® Tap Box and in the maintenance section of this manual.

Definitions

- **Cam-lock:** A single pole device commonly found on generators and tap boxes. The device enables the user to quickly connect and disconnect without to use of tools.
- **Busbar:** In electric power distribution, a busbar is a metallic bar or strip, typically found inside a panel, switchgear, and busway enclosures. Busbar provides connectivity between two electrical sources.
- **Generator Cable Trapped Door:** A hinged door, that allows generator cables to securely connect to the tap box and minimizes risk of removing cables while the main door is closed and properly locked.
- **Circuit Breaker:** an automatic device for stopping the flow of current in an electric circuit as a safety measure.
- **Emergency Source:** The electrical power supplied by the generator.
- **Emergency System:** Emergency Systems have special requirements as specified by law. Powertron® Tap Boxes are not intended for use in Emergency Systems as defined by NFPA/NEC Chapter 7, Article 700.
- **Field Assembled:** is a process by which products are designed to be installed within the field with minimal fabrication and ease of installation.
- **Generator:** Electrical/Mechanical device that converts mechanical energy into electrical energy.
- **Ground-Fault Circuit Interrupter (GFCI):** A device intended for the protection of persons that functions to de-energize a circuit within an established period of time when a current to ground.
- **Normal Source:** The electrical power supplied by the local electrical utility company.
- **Pass Through Device:** Electrical connection point that does not have over current, fault or other protection capabilities.
- **Penta Bolt:** Penta bolts are tamper resistant, having pentagonal heads that cannot be loosened by typical hardware store tools.
- **Power Distribution Block:** Block for making the connection of the conductors from building's transfer switch (lower lugs of block are factory connected to back of plugs).
- **Tap Box:** A pass through device that provides connection points for electric cables from the generator.
- **Transfer Switch:** An automatic or manual device for transferring one or more load conductor connections from one power source to another.
- **cULus 1008 Listing:** If a certain product is cULus Listed, it means that UL tested the product to meet all the requirements under Canadian and US standards. Anything that has cULus mark can be used both in Canada and US. This listing recognizes standby systems that allow portable generator connection, UL 1008 is the proper standard for transfer switches and tap boxes.
- **UL Verified Mark:** UL Verification is an objective, science-based assessment that confirms the accuracy of marketing claims. UL's independent certification process analyzes the validity of specific advertising or promotional statements, a separate verified fact from the ambiguous. To learn more, go to www.verify.ul.com.

Installation

Intended Use Statement:

Powertron® Tap Boxes are pass-through devices. Depending on the model, they provide a connection point for either a Wye or Delta wired portable generator and a pre-installed transfer switch. Upon loss of utility supplied electric power a correctly matched portable generator can be easily connected to a building where a Powertron® Tap Box has been installed.

Notice to Installer:

Powertron® Tap Boxes should only be installed by qualified persons (see Definition's section). Depending on your local building codes and ordinances a qualified licensed electrician, electrical contractor, or engineer should perform the installation after determining the following:

- Building's load requirements
- Building's 3Ø voltages and phase sequencing (rotation direction)
- Generator capacity required to meet load
- Proper size of Powertron® Tap Box
- Parking location for portable generator
- Cable lengths from transfer switch to Tap Box
- Cable length from Tap Box to generator
- Cable conductor material and size (ampacity)



Refer to the connection diagrams in the electrical connection section of this manual to confirm you have the correct model for this installation.



Powertron® Tap Boxes are partially wired at the factory. Internal connections to a building's transfer switch and grounding system must be completed before use.

If the included GFCI outlet is to be installed it must be connected to the load side of the building's load center. If it is desired for the outlet to remain powered when the Emergency Source is operating then it should be connected to a branch circuit that is energized by the transfer switch when operating on the Emergency Source. Do not connect GFCI to the tap box copper bus bar or power distribution block. It is recommended that the GFCI be connected to a dedicated branch circuit breaker so that the circuit does not become overloaded when supplying the generator block heater and battery charger.



Receptacle shall be upstream branch circuit protected. The rating of the protection cannot exceed the rating of the receptacle.

Considerations when Locating your Powertron® Tap Box

1. Access by unauthorized persons or vandals should be considered when selecting the location to install the Powertron® Tap Box. Appropriate door latching and locking hardware should be selected to meet your needs.
2. Powertron® Tap Boxes are designed to be installed on the exterior of a building. To reduce the length of cabling from the building's transfer switch, a typical installation would be near the utility service entry point. The transfer switch is normally located inside the building near this entry point and near the main electrical distribution panels.
3. A hard surface parking place should be selected for the portable generator near the Powertron® Tap Box. Choose a location that is likely to be easily accessible should there be a loss of utility power.
4. It is recommended that the Powertron® Tap Box should be installed where the generator cables can be connected by a person standing on firm ground without the need to use a ladder.
5. A correctly installed (located) Powertron® Tap Box should allow easy access for maintenance.
6. You should consider placing the Powertron® Tap Box away from areas where it might be damaged by vehicles, lawn maintenance equipment, trash trucks, dumpsters, or loading dock equipment.
7. Powertron® Tap Box should not be located where a lawn/irrigation system would spray water directly on it.
8. If unusual conditions exist where the Powertron® Tap Box is to be installed, contact your Powertron® representative. Unusual conditions include but are not limited to: chemical fumes, explosive vapors or dusts, salt laden air, vibration or shock loading, ungrounded power system, or below ground level in a pit.

Connecting your Tap Box To Building

1. Review Hoffman® Enclosure Manual supplied with the Powertron® tap box.



To ensure proper sealing and enclosure protection rating, use the provided sealing washers. Install the sealing washers inside the enclosure with tapered cone against the enclosure and then add the flat washers.

2. After determining the required size for the cable from the transfer switch to the tap box, an appropriate size conduit should be selected.



To maintain the Tap Box NEMA 3R rating, only use a conduit hub with a proper gasket.

3. The Powertron® Tap Box provides a variety of options when installing conduit to its enclosure. Use *Figure 1* and *Chart 1* for recommended conduit entry points and measurements when installing the Powertron® Tap Box. Extra care should be taken when connecting through the back panel so that the conduit hub does not interfere with the mounting of the box flush to wall.

Conduit Entry Area	
A	Entry area: Measure 2" from back of enclosure
B	Entry area: Measure 2" from top of enclosure
C	Entry area: Measure 2" from top and side of enclosure *

**Conduit entry point can be on either side of enclosure.*

Chart 1

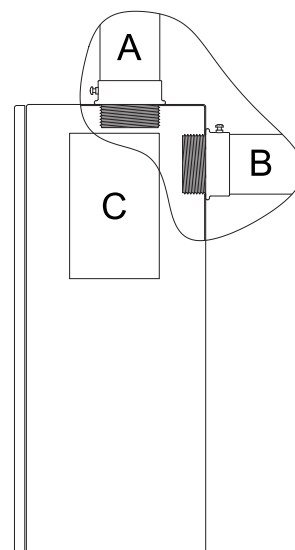

Figure 1

The above illustrates locations of conduit entry points for the Powertron® Tap Box. See *Chart 1* for approximate measurements.

4. When creating the conduit hole in the tap box, cover pre-installed wires and power distribution block or copper bus bar to prevent metal shavings or filings from falling on them. Clean any stray metal pieces from the Powertron® Tap Box before installation is deemed complete.

5. The Tap Box must be mounted level and plumb to allow proper drainage. Do not block the small weep holes located in bottom of the Tap Box.

6. Tap Box must be securely fastened to the building with a minimum (4X) 3/8" fasteners. Use appropriate fasteners for the building wall material. The wall must be able to support 350 pounds and may need to utilize appropriate lifting method. See *Figure 3* for mounting hole pattern.

7. See *Unit and Shipping Weight* section for approximate tap box weight.

Electrical Connections to Building



Warning – Electrical

1. Do not attempt to use the Powertron® Tap Box for any purpose before it is fully installed.
2. A Transfer Switch must be installed between the Powertron® Tap Box and the building's load center (power distribution panels) that are connected to the normal source (local electrical utility company). **Failure to install a Transfer Switch will allow generator power to energize the utility lines and put utility workers at risk of electrocution.**

Figure 2

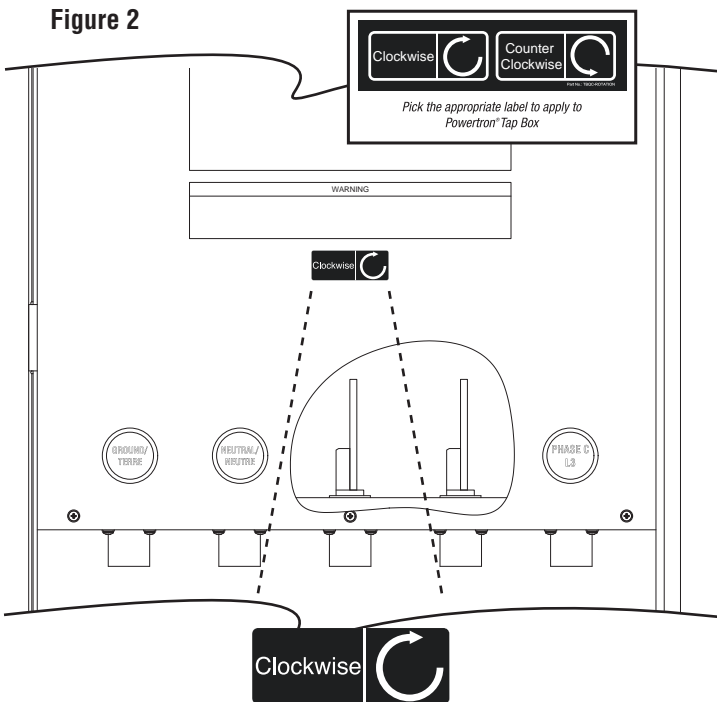

ABOVE IS AN EXAMPLE TO ILLUSTRATE THE LOCATION OF THE LABEL ONLY!

3. The Powertron® Tap Box connection to the transfer switch must only be made by a qualified person, with the transfer switch locked out from utility power.
4. Make sure the voltages are correctly indicated on the Powertron® Tap Box.
5. After determining the phase rotation, select appropriate label from the provided Phase Rotation label and apply to the Powertron® Tap Box. See *Figure 2* for example of the location for the Phase Rotation label.
6. If aluminum cable is used connecting to:
 - **Power Distribution Block:** Apply joint compound designed specifically for aluminum connections.
 - **Copper Bus Bar:** Use cable lugs designed specifically for aluminum connectors.



Warning – Grounding

1. Refer to the current edition of NFPA 70: National Electric Code, Article 445 for grounding of generators and Article 250 for general information on grounding.
2. The installer should make certain that a solid and permanent metallic connection between the building ground point and the Powertron® Tap Box is in place by:
 - a. Installing a ground cable from the power distribution block or copper ground bus bar to the building ground point.
 - b. A grounding jumper must be installed from the power distribution block or copper bus bar ground to the ground lug on the enclosure.
3. Conduit should not be relied upon to provide grounding protection to tap box.
4. The GFCI supply conductors should include a separate ground conductor.

Tap Box Components & Parts

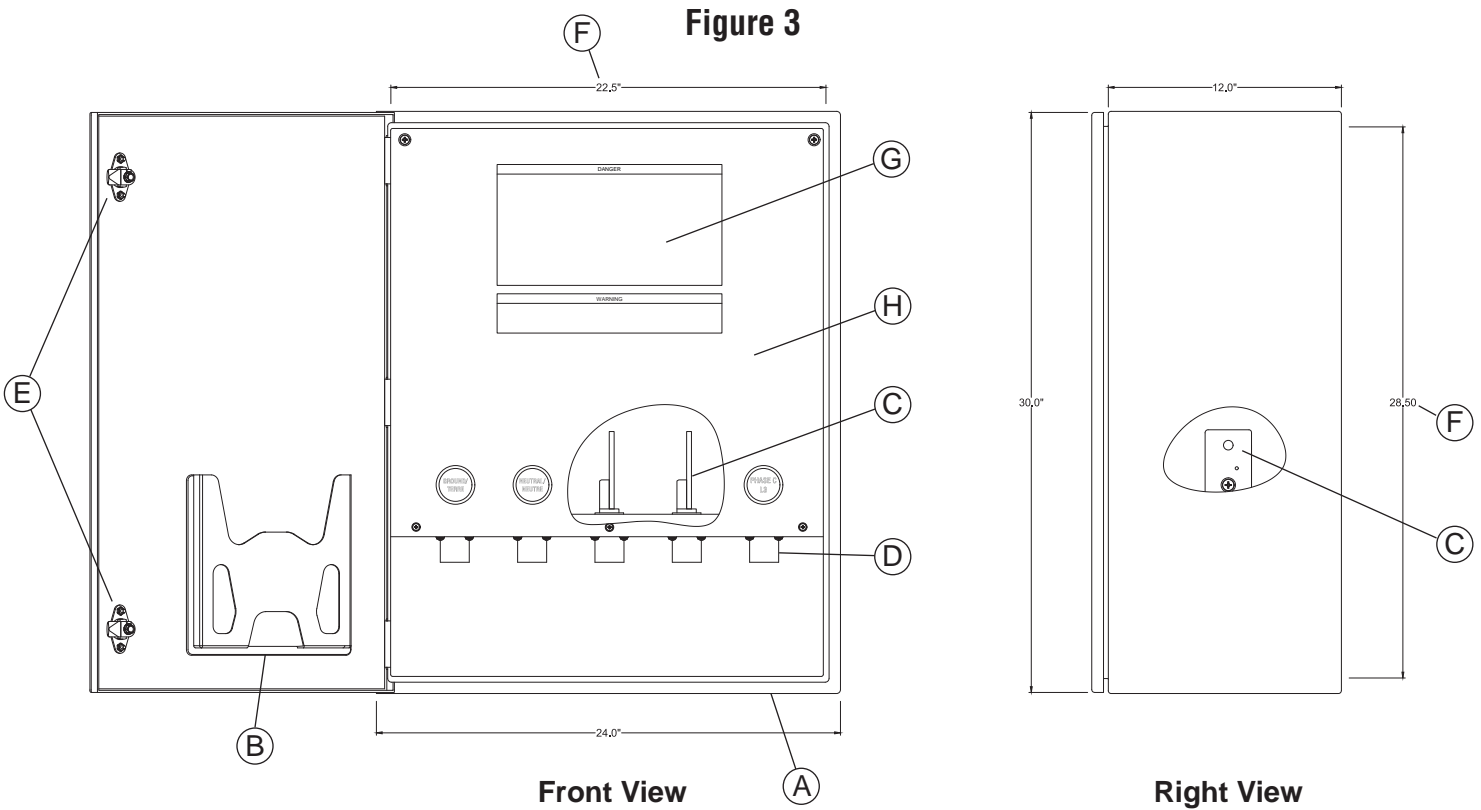

Standard Components and Parts

A	Trapped Cable Door	Additional Parts (Not Shown):
B	Literature Holder ⚠ Read and follow the component manufacturer's instructions and warnings provided	
C	(5X) Copper Bus Bar, Tin Plated per bus bar mounting holes 0.50" dia.	<ul style="list-style-type: none"> • Safety and Product Labels • Grounding Jumping Cables • Gravity Cam-Lock Cover Plate • Gravity Cam-Lock Cover Plate Stopper Bracket
D	Series 16, 400 Amp, 600 VAC, Single Pole Cam-Lock Receptacle	Notes:
E	Door Latches	
F	Mounting Hole Pattern – (4X) 0.50" dia.	
G	Safety and Warning Labels	
H	Removable Panel Cover	

Electrical Connections to Generator

Warning

1. Follow all Warnings and Instructions provided by the generator manufacturer.
2. Connection of generator to Powertron® Tap Box must be made by a qualified person.
3. Tap Box does not provide over current protection or phase synchronization or detection. Ensure that the generator's fault protection is in place.
4. All cables must be connected and disconnected to the Tap Box with the generator not operating.
5. Disable the generator's automatic starting circuit to prevent inadvertent starting.
6. Generator voltage and phase sequence must match what is marked on Powertron® Tap Box. A wrong phase sequence connection will cause damage to motors and other electrical equipment.
7. Cable receptacles are limited to 400 amps each. See diagram below for Powertron® Tap Boxes:





















Amperage: 100A to 400A	Amperage: 600A to 800A	Voltage	Ground	Neutral	L1	L2	L3	100A-400A	600A-800A
Phase: 3 Phase	Phase: 3 Phase	208Y/120						x1 Row	x2 Rows
Fully Rated Ground: Yes	Fully Rated Ground: Yes	240/120						x1 Row	x2 Rows
Number of Cables: 5 pcs.	Number of Cables: 10 pcs.	480Y/277						x1 Row	x2 Rows
		600/347						x1 Row	x2 Rows

Figure 4

Connection Diagrams for Powertron® Tap Box Models

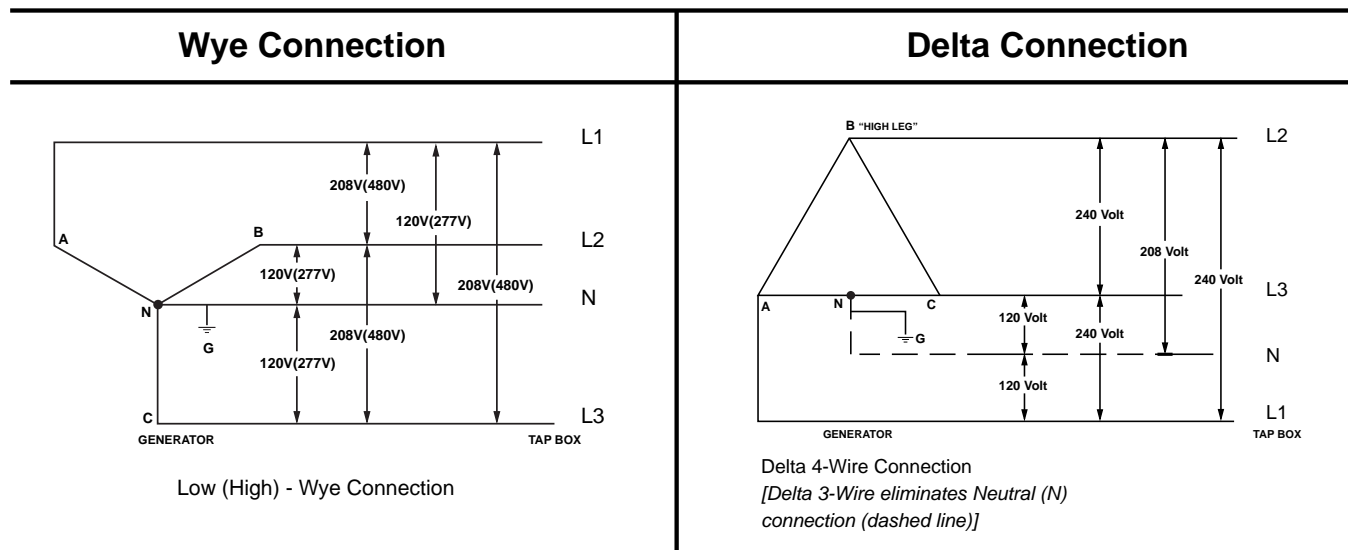

Connecting the Generator to the Tap Box

1. Confirm that the generator output voltage and Powertron® Tap Box voltage match.
 - a. Plug connectors are colored to indicate voltage. Green and White indicate Ground and Neutral terminals.
 - b. 3 phase terminals that are 208Y/120, 240/120, and 347/600 Volts are colored Black, Red and Blue.
 - c. 3 phase terminals that are 480Y/277 Volts are colored Brown, Orange, and Yellow.
2. Check that the generator is off using proper lockout/tagout procedures.
3. Disable any automatic generator starting circuit to prevent inadvertent starting while making connections.
4. Connect the generator ground (green) cable(s) first.
5. Then the neutral (white) cable(s) second.
6. Connect the 3 phase cables last. The phase sequence of the generator connections must follow the phase sequence marked on Powertron® Tap Box lower cabinet.
7. Proceed with generator manufacturer's starting procedures.
8. If appropriate, enable the generator's automatic starting circuit.
9. When disconnecting remove the 3 phase cable(s) first, then neutrals and grounds last.
10. Follow generator's instructions for connecting its battery charger and block heater to the GFCI outlet in the Tap Box.



Keep bystanders away from Powertron® Tap Box, Generator, and cables.



Mark a hazardous zone with caution tape or flagging to alert persons to not enter area of generator or cables.



Follow all Lockout/Tagout and Arc Flash procedures.

Maintenance and Service of Powertron® Tap Box

- The Powertron® Tap Box, like all electrical equipment, requires periodic maintenance. Maintenance is important because the tap box may be installed and stand idle for a long period of time before it is required.
 - For continued business operation when an unexpected loss of normal source power occurs, it is important that the Powertron® Tap Box be kept ready for use.
 - Powertron® recommends, at a minimum, an annual inspection of the Tap Box. Proper maintenance will provide many years of “ready to use” service.
 - A correctly installed (located) Powertron® Tap Box should allow easy access for maintenance. See section titled, *Maintenance and Post Installation Check List* as general guidelines for your maintenance program.
 - Because of the variety of locations and applications of the Powertron® Tap Box not all maintenance issues can be anticipated. Additional items may be required at your installation.
- Periodically check cam-lock plate is properly installed and covering cam-lock openings on the bottom of the enclosure.



Maintenance should be performed by a qualified person.



Before any maintenance is attempted the generator must be disconnected and the circuit breaker supplying the GFCI outlet must be open and locked out.

POWERTRON®

P.O. Box 160

Nokomis, Illinois, 62075

800.221.7665

www.powertronsolutions.com

PART #: TBQCC-1080-MAN