

STRONG

 **Google TV**

HD SMART TV 24"

SRT 24HG4723C



Subject to alterations

Installation instructions

SERVICE CENTER

AT	 support_at@strong-eu.com 0820 400 150 (€ 0,12/Min. österr. Festnetz)	HU	 support_hu@strong-eu.com +36 1 445 26 10
BG	 support_bg@strong-eu.com +359 32 634451	IT	 support_it@strong-eu.com
CZ	 support_cz@strong-eu.com 844 44 44 90	NL	 support_nl@strong-eu.com
DE	 support_de@strong-eu.com 0800 7788 787 (Gebührenfrei)	PL	 support_pl@strong-eu.com 801 702 017
DK	 support_dk@strong-eu.com	PT	 support_pt@strong-eu.com +351 2 100 06 125
ES	 support_es@strong-eu.com +34 91 119 61 76	SK	 support_sk@strong-eu.com 0850 15 05 50
FR	 support_fr@strong-eu.com	SL	 +386 1 828 08 58
HR	 +385 1 344 57 66	UA	 support_ua@strong-eu.com +380 (44) 238 61 50

Supplied by STRONG Austria
Represented by STRONG Ges.m.b.H.
Teinfaltstraße 8/4.Stock
A-1010 Vienna, Austria
Email: support_at@strong-eu.com

Licenses

This product contains one or more programs protected under international and U.S. copyright laws as unpublished works. They are confidential and proprietary to **Dolby Laboratories**. Their reproduction or disclosure, in whole or in part, or the production of derivative works therefrom without the express permission of Dolby Laboratories is prohibited. Copyright 2003-2009 by Dolby Laboratories. All rights reserved.

THIS PRODUCT IS SOLD WITH A LIMITED LICENSE AND IS AUTHORIZED TO BE USED ONLY IN CONNECTION WITH HEVC CONTENT THAT MEETS EACH OF THE THREE FOLLOWING QUALIFICATIONS: (1) HEVC CONTENT ONLY FOR PERSONAL USE; (2) HEVC CONTENT THAT IS NOT OFFERED FOR SALE; AND (3) HEVC CONTENT THAT IS CREATED BY THE OWNER OF THE PRODUCT. THIS PRODUCT MAY NOT BE USED IN CONNECTION WITH HEVC ENCODED CONTENT CREATED BY A THIRD PARTY, WHICH THE USER HAS ORDERED OR PURCHASED FROM A THIRD PARTY, UNLESS THE USER IS SEPARATELY GRANTED RIGHTS TO USE THE PRODUCT WITH SUCH CONTENT BY A LICENSED SELLER OF THE CONTENT. YOUR USE OF THIS PRODUCT IN CONNECTION WITH HEVC ENCODED CONTENT IS DEEMED ACCEPTANCE OF THE LIMITED AUTHORITY TO USE AS NOTED ABOVE.

SIMPLIFIED EU DECLARATION OF CONFORMITY

Hereby, STRONG declares that the devices SRT 24HG4723C is in compliance with Directive 2014/53/EU.

The full text of the EU declaration of conformity is available at the following internet address: <https://eu.strong-eu.com/downloads/>

Subject to alterations. In consequence of continuous research and development technical specifications, design and appearance of products may change. Manufactured under license from Dolby Laboratories. Dolby, Dolby Audio, and the double-D symbol are trademarks of Dolby Laboratories Licensing Corporation. The terms HDMI, HDMI High-Definition Multimedia Interface, HDMI Trade dress and the HDMI Logos are trademarks or registered trademarks of HDMI Licensing Administrator, Inc. Wi-Fi is a registered trademark of Wi-Fi Alliance®. Netflix is a registered trademark of Netflix, Inc. YouTube™ is a trademark of Google Inc. All product names are trademarks or registered trademarks of their respective owners.

© STRONG 2025. All rights reserved.

TABLE OF CONTENTS

To obtain the best performance and safety, please read this manual carefully. Please keep this manual for future reference.



1.0 INSTRUCTION	4
1.1 SAFETY INSTRUCTIONS	4
1.2 STORAGE	4
1.3 ACCESSORIES	4
1.4 EQUIPMENT SET-UP	5
2.0 INSTALLATION	5
2.1 PASSWORD SETTING	5
2.2 FRONT PANEL	5
2.3 REAR PANEL	6
2.4 REMOTE CONTROL	7
2.5 INSTALLING THE BATTERIES	8
2.6 USING THE IR REMOTE CONTROL	8
3.0 FIRST TIME INSTALLATION	9
3.1 CHANNEL INSTALLATIONS FOR CABLE	11
3.2 CHANNEL INSTALLATIONS FOR ANTENNA	12
3.3 CHANNEL INSTALLATIONS FOR SATELLITE	13
4.0 HOME SCREEN	16
4.1 INPUTS	17
4.2 NETWORK & INTERNET	17
5.0 LIVE TV USAGE	20
5.1 CHANNEL INSTALLATION	20
5.2 WATCHING TV CHANNELS	20

5.3 ELECTRONIC PROGRAM GUIDE (EPG)	21
5.4 TV MENUS	21
6.0 SMART TV POSSIBILITIES	22
7.0 SYSTEM SETTINGS	23
7.1 SETTINGS MAIN MENU	23
7.2 SYSTEM MENU	23
8.0 MULTIMEDIA	23
8.1 REMINDER WHEN USING THE USB STORAGE DEVICES	23
8.2 MULTIMEDIA PLAYER	24
8.2.1 PLAY VIDEOS	25
8.2.2 BROWSE PHOTOS	26
8.2.3 PLAY MUSIC	26
8.2.4 BROWSE FILES	27
9.0 TROUBLESHOOTING	27
10.0 SPECIFICATIONS	29

1.0 INSTRUCTION

1.1 SAFETY INSTRUCTIONS

Read all of the instructions before operating the set. Keep these instructions well for later use.

- Only use attachments/accessories specified or provided by the manufacturer (such as the exclusive supply adapter, battery etc.).
- Please refer to the information on the exterior back enclosure for electrical and safety information before installing or operating the apparatus.
- To reduce the risk of fire or electric shock, do not expose this apparatus to rain or moisture.
- The ventilation should not be impeded by covering the ventilation openings with items, such as newspaper, table-cloths, curtains, etc.
- The apparatus shall not be exposed to dripping or splashing and no objects filled with liquids, such as vases, shall be placed on the apparatus.
- The mark  indicates a risk of electric shock. The external wires must be installed by an instructed person or ready-made leads or cords must be used.
- To prevent injury, this apparatus must be securely attached to the floor/wall in accordance with the installation instructions.
- Danger of explosion if the battery is incorrectly replaced. Replace only with the same or equivalent types.
- The battery (battery or batteries or battery pack) shall not be exposed to excessive heat such as sunshine, fire or the like.
- Excessive sound pressure from earphones and headphones can cause hearing loss.
- Listening to music at high volume levels and for extended durations can damage one's hearing.
- In order to reduce the risk of damage to hearing, one should lower the volume to a safe, comfortable level, and reduce the amount of time listening at high levels.
- The mains plug or appliance coupler is used as disconnect device, it shall remain readily operable. When not in use and during movement, please take care of the power cord set, e.g. tie up the power cord set with cable tie or something like that. It shall be free from sharp edges or similar which can cause abrasion of the power cord set. When put into use again, please make sure the power cord is not damaged. In case of damages, please get the power cord replaced by a similar one with the same specifications. The absence of a light indication on the apparatus does not mean that it is fully disconnected from the mains. To disconnect the apparatus completely, the mains plug must be pulled out.
- Attention should be drawn to environmental aspects of battery disposal.
- No naked flame sources, such as lighted candles, should be placed on the apparatus.
-  To prevent the spread of fire, keep candles or other open flames away from this product at all times.
- A USB terminal can provide a maximum of 500 mA.
-  Equipment with this symbol is a Class II or double insulated electrical appliance. It has been designed in such a way that it does not require a safety connection to electrical earth.

Operating Environment

- Do not install this equipment in a confined space such as a bookcase or similar unit.
- Do not use the set near damp, and cold areas, protect the set from overheating.
- Keep away from direct sunlight.
- Do not use the set near dust place.
- Do not attach candle to accessible opening area, to avoid flammable foreign material from entering the TV.

WEEE Directive



Correct Disposal of this product. This marking indicates that this product should not be disposed with other household wastes throughout the EU. To prevent possible harm to the environment or human health from uncontrolled waste disposal, recycle it responsibly to promote the sustainable reuse of material resources. To return your used device, please use the return and collection systems or contact the retailer where the product was purchased. They can take this product for environment-safe recycling.

1.2 STORAGE

Your device has been carefully checked and packed before shipping. When unpacking it, make sure that all the parts are included and keep the packaging away from children. We recommend that you keep the carton during the warranty period, to keep your device perfectly protected in the event of repair or warranty.

1.3 ACCESSORIES

- 1x User Manual
- 1x Safety Instructions/Warranty Cards
- 1x Remote control
- 2x AAA batteries
- 1x Central stand (composed of three parts)
- 6x Screws for feet
- 1x Power cable
- 1x Power adaptor (200V-12V)
- 1x Car adaptor (12V)

1.4 EQUIPMENT SET-UP

Fig. 1

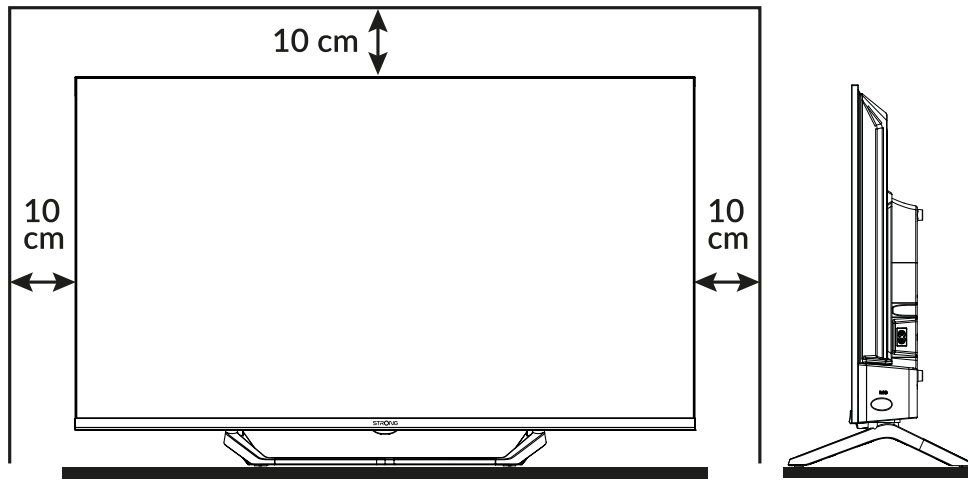

Install the display on a solid horizontal surface such as a table or desk. For ventilation, leave a space of at least 10 cm free all around the set. To prevent any fault and unsafe situations, please do not place any objects on top of the set. This apparatus can be used in tropical and/or moderate climates.

NOTE: Clean the screen with a soft, dry cloth after switching off and unplugging the television and avoid glass sprays and other household cleaning agents.

This user manual provides complete instructions for installing and using this TV. The symbols serve as follows:

- WARNING** Indicates warning information.
- NOTE** Indicates any other additional important or helpful information.
- MENU** Represents a button on the remote control or the TV.
- Move to* Represents a menu item within a window.

2.0 INSTALLATION

2.1 PASSWORD SETTING

The Password is set by the user during the first installation described in chapter 3 (Step 5). It is possible to insert a code of your choice but remembering that to reset the password it will be necessary to reset the system making it return to the factory settings, losing all the settings set by the user.

2.2 FRONT PANEL

Fig. 2

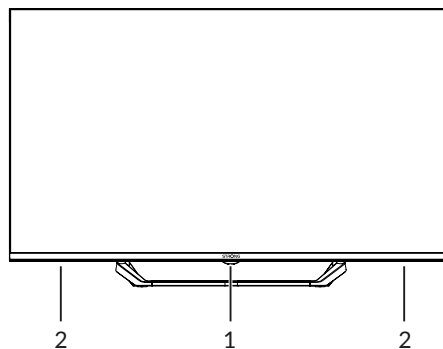

NOTE: The graphics are for representation only.

- 1. Power indicator /remote sensor
- 2. Speakers

2.3 REAR PANEL

NOTE: The graphics are for representation only.

Fig. 3

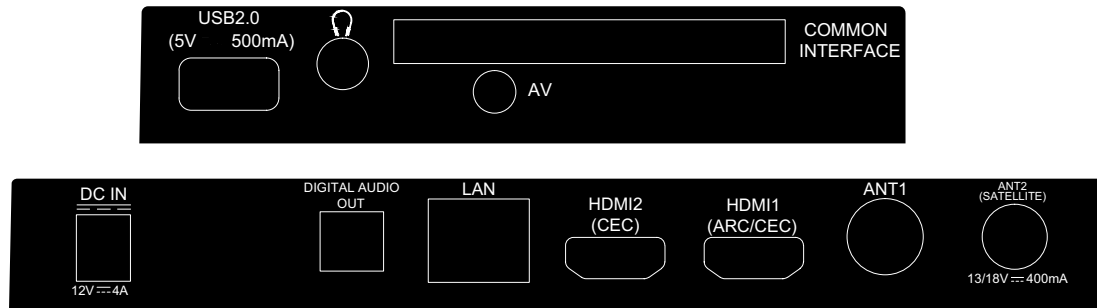

- | | |
|---|--|
| <p>1. USB 2.0</p> <p>2. HEADPHONE</p> <p>3. CI</p> <p>4. AV IN</p> <p>5. DC IN</p> <p>6. DIGITAL AUDIO OUT (optical)</p> <p>7. LAN</p> <p>8. HDMI 2 (CEC)</p> <p>9. HDMI 1 (ARC/CEC)</p> <p>10. ANTENNA IN 1</p> <p>11. ANT 2/ SAT IN</p> | <p>USB 2.0 port.</p> <p>Headphone or Earphone audio output, speakers will be muted when earphone is plugged in and headphone selected.</p> <p>Insert a Conditional Access Module (CAM).</p> <p>To connect your DVD player or other device using 3.5 mm AV cable to your TV to play videos on your TV screen.</p> <p>12V connector to plug your 12V cable</p> <p>Use an optical cable to connect your TV to a compatible digital amplifier or Home theatre set.</p> <p>Connect to your Internet router to access the internet/apps.</p> <p>Connect HDMI input signal from a signal source such as DVD, Blu-ray player or game console.</p> <p>Connect HDMI input signal from a signal source such as DVD, Blu-ray player or game console or directly to a Digital Amplifier that supports the ARC function. This input is equipped with the ARC (Audio Return Channel) feature to implement audio connections and for a full Dolby Audio support.</p> <p>Connect a coaxial cable to receive signal from the DVB-T/T2 antenna or DVB-C cable.</p> <p>Connect a coaxial cable to receive DVB-S/S2 satellite signal from the Dish LNB.</p> |
|---|--|

NOTE: If the TV turns off when you plug a cable to any connector, just turn it on again.

2.4 REMOTE CONTROL

Fig. 4

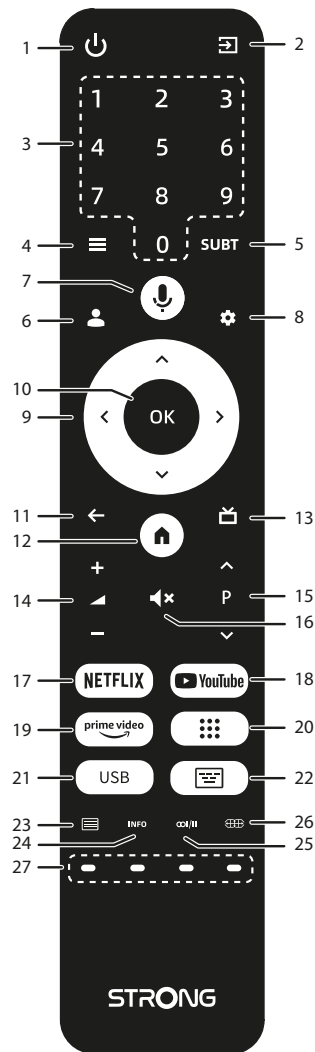

- 1.
- 2.
3. 0 ~ 9
- 4.
5. SUBT
- 6.
- 7.
- 8.
- 9.
10. OK
- 11.
- 12.
- 13.
14. VOL +/-
- 15.
16. P +/-
17. NETFLIX
18. YouTube
19. prime video
- 20.
21. USB
- 22.
- 23.
24. INFO

1. Press to turn the TV on or standby.
2. Press to access the TV sources.
3. Choose channel directly.
4. Press to access the menu options in TV mode.
5. Enable/disable subtitles in DTV mode.
6. Press to choose an account.
7. Press to activate the voice control function*.
8. Press to access the TV settings.
9. Navigate the menu.
10. Confirm the selection.
11. Press to go back to previously viewed channel. In menu: Back to previous menu.
12. Enter the home desktop.
13. Press to display EPG info in TV mode.
14. Adjust the volume up or down.
15. Press to mute or restore the volume.
16. Change programmes up or down.
17. Press for direct access to Netflix**.
18. Press for direct access to YouTube.
19. Press for direct access to prime video***.
20. Press to display the apps list.
21. Enter the Multimedia menu.
22. Displays the keyboard in LiveTV mode.
23. Press to enter the teletext.
24. Press to displays the channel info in LiveTV mode.

25. Audio track selection.

26. Press to change the screen settings.

27. **COLOUR BUTTONS**

Use in accordance with the Operation interface instructions.

*Voice control and some other functions could work only when this RCU paired with your TV.

** Membership is not included. Netflix is available in selected countries. Streaming Netflix requires to set up an account. Broadband Internet required. See www.netflix.com/TermsOfUse for details.

*** Membership is not included. Prime is available in selected countries. Streaming prime video requires to set up an account. Broadband Internet required. See www.primevideo.com for details.

2.5 INSTALLING THE BATTERIES

Fig. 5

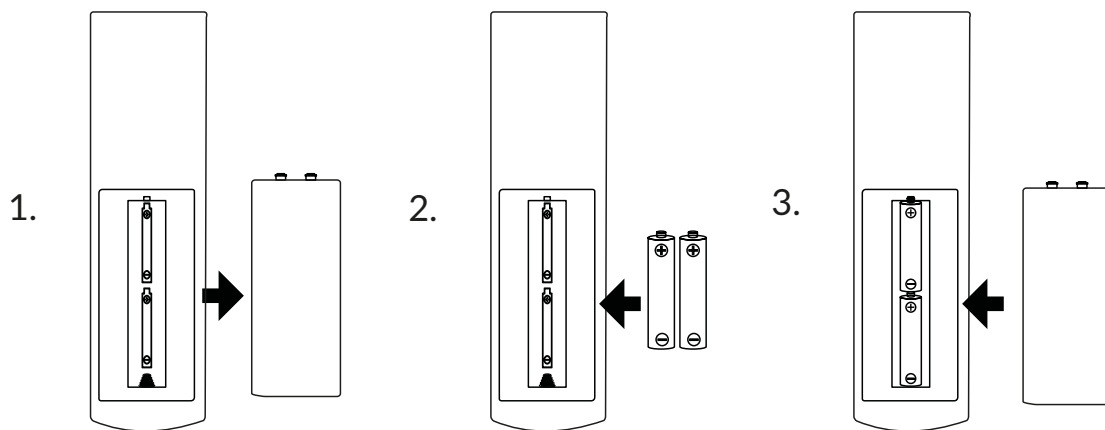

Remove the battery cover from the remote control and put 2x AAA size batteries inside the compartment. Make sure to match the polarity markings inside the compartment.

NOTE: Pictures are for reference only. Actual items may be different.

- 1 Open the cover.
- 2 Put batteries in the compartment and make sure the polarity is correct.
- 3 Close the cover.

Precautions for using the battery

Improper using of the battery will cause leakage. Carefully follow these instructions.

1. Please note the batteries' polarity to avoid short circuit.
2. When the battery's voltage is insufficient which affects the use range, you should replace it with a new battery. Remove the batteries from the remote-control unit if you do not intend to use it for a long time.
3. Do not use different types of batteries (for example Manganese and Alkaline batteries) together.
4. Do not put the battery into fire, and charge or decompose the battery.
5. Please dispose batteries abide by relevant environmental protection regulation.

2.6 USING THE IR REMOTE CONTROL

- Use the remote control by pointing it towards the remote sensor. Items between the remote control and the remote sensor could block normal operation.
- Do not cause the remote control to vibrate violently. Also, do not splash liquid on the remote control or put the remote control in a high humidity place.
- Do not place the remote control under direct sunlight which will cause deformation of the unit by heat.
- When the remote sensor is under direct sunlight or strong lighting, the remote control will not work. If so, please change the lighting or TV's position, or operate the remote control closer to the remote sensor.

*to confirm your choices use OK button or button.

3.0 FIRST TIME INSTALLATION

After all connections have been made properly, switch your TV on.

Please follow the initial First Time Installation (FTI) procedure on your screen and complete the installation. It will take a few minutes.

Step 1

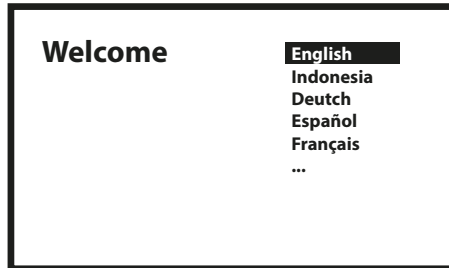

Select your preferred language and location on the welcome page, press **OK** to go to the next step.

Step 2



Selection of the type of installation.

There are two different installation ways, one complete and one basic, depending on your needs.

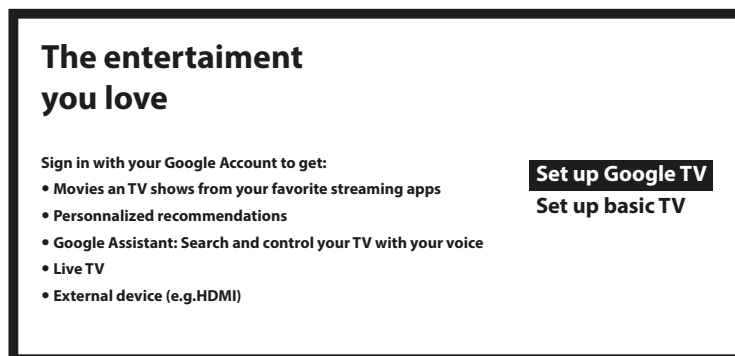

With basic TV, you will get: Live TV and external devices (e.g. HDMI)

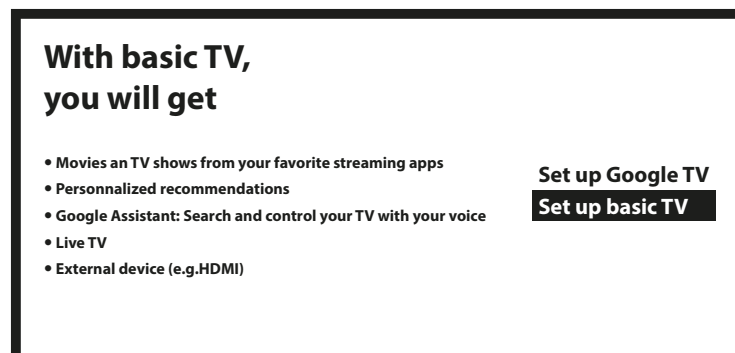

You can easily transfer your Android phone's Wi-Fi network and Google Account to your TV.

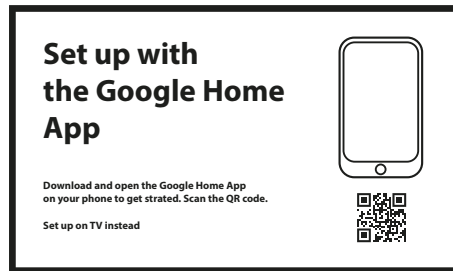

Step 3

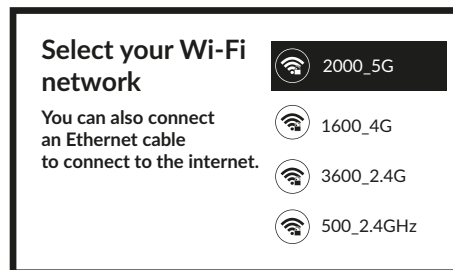

Select your Wi-Fi network to connect to the Internet. Alternatively, it is also possible to connect an Ethernet cable to the input on the back.

Step 4

After internet installation it's time for the account.

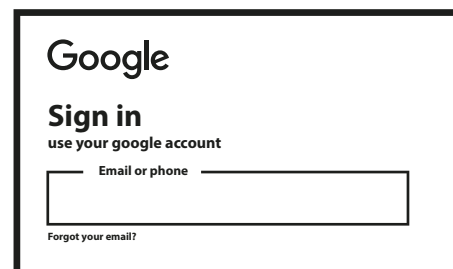

Step 5

Pairing the remote control.

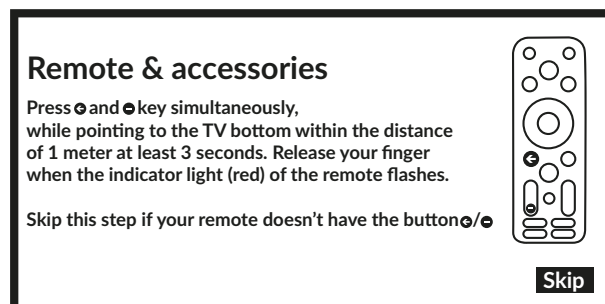

Buttons to press simultaneously.

Password setting

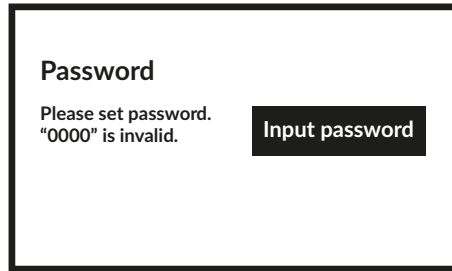

Tuner selection.

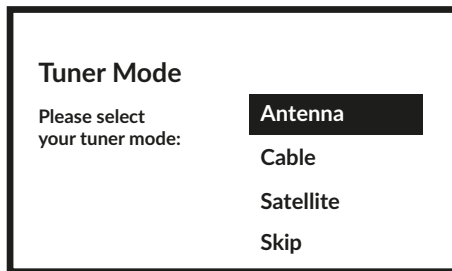

To install channels for terrestrial, satellite or cable broadcasting please select *Antenna*, *Cable* or *Satellite* and choose required type of channels *Digital*, *Analogue*.

In case you are not interested in installing any TV channels press *Skip*. This way the TV would finish the installation.

3.1 CHANNEL INSTALLATIONS FOR CABLE

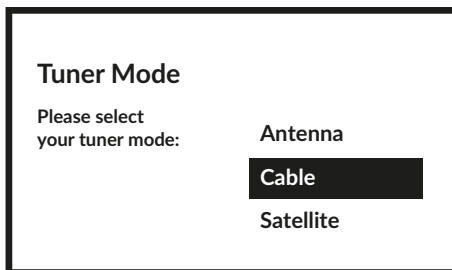

Select the tuner mode *Cable* and press **OK** to continue.

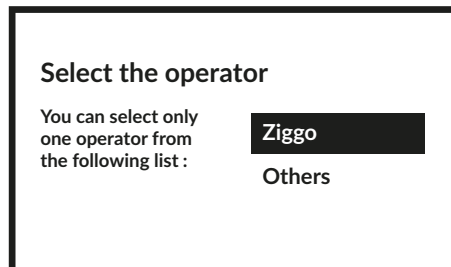

Select one operator from the following list, or select *Other* if you don't have a predefined operator or it is different from those listed. Once done press **OK** to continue.

NOTE: Not all countries have predefined operators. If the country you have selected does not have one this step will be skipped.

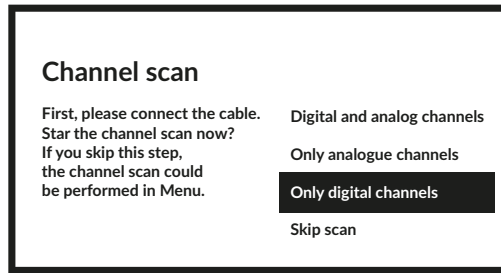

First step is to connect the cable. Then you must start the channel scan. You can choose between *digital and analogue channels*, *only analogue channels* or *only digital channels*. If you skip this step, the channel scan can be done later by accessing the TV menu. Press **OK** for your selection.

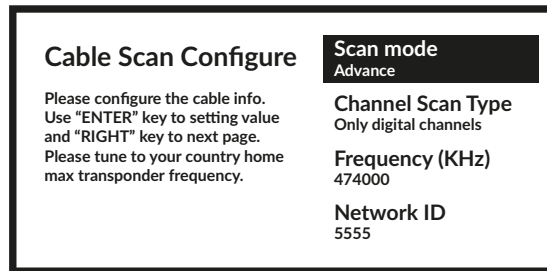

On the *Scan Mode* menu you can choose to perform a full scan by selecting *Full*, while selecting *Advance* you can perform a scan using the Frequency and Network ID data provided by your operator. Use the **OK** button for setting the value and **▶** to start the channel scan.

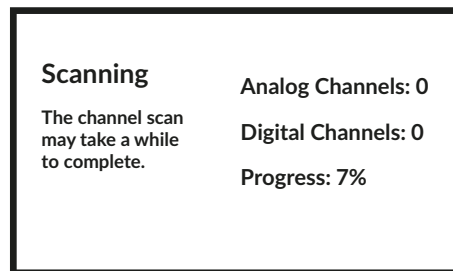

In the next step the channel scan started and will take some minutes to complete.

3.2 CHANNEL INSTALLATIONS FOR ANTENNA

Select the tuner mode Antenna and press **OK** to continue.

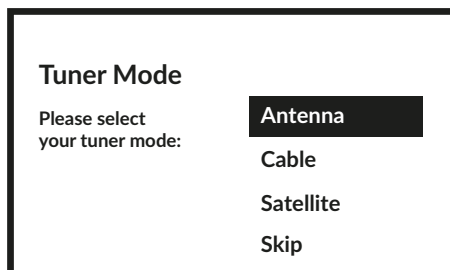

Select the preferred method of channel ordering.

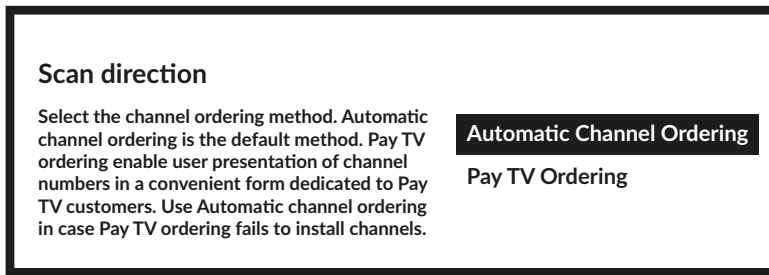

The *Automatic channel ordering* is the default method. *Pay TV ordering* allows the customer to select the display of channel numbers that is suitable for them. Use *Automatic channel ordering* when Pay TV ordering cannot install channels. Press **OK** to continue.

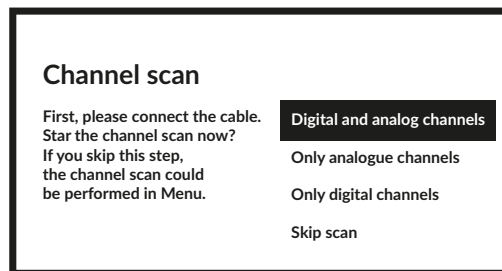

First step is to connect the Antenna cable. Then you must start the channel scan. You can choose between *Digital and analogue channels*, *Only analogue channels* or *Only digital channels*. If you skip this step, the channel scan can be done later by accessing the TV menu. Press **OK** for your selection.

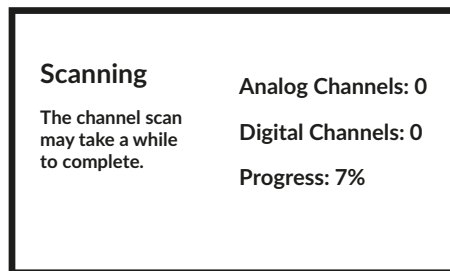

In the next step, the channel search is started and takes a few minutes.

3.3 CHANNEL INSTALLATIONS FOR SATELLITE

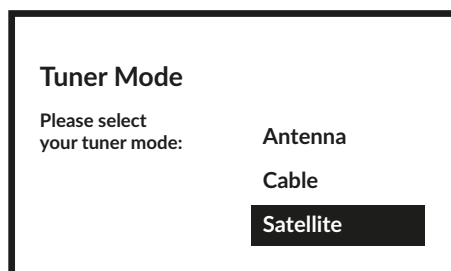

Select the tuner mode *Satellite* and press **OK** to continue.

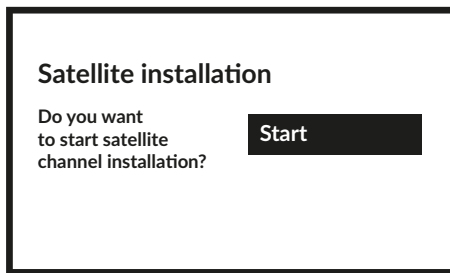

Press **OK** to start with the satellite channel installation.

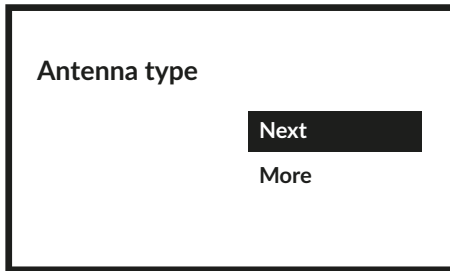

By selecting *Next* you go to the *Select the Operator* page, while by selecting *More* you access the *Satellite antenna type* page if it is necessary to set the DiSEqC or Unicable.

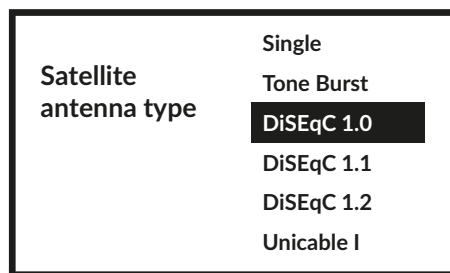

If you are looking for the LNB list you have to go to *General* and press **OK**.

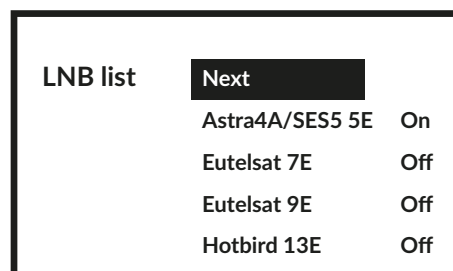
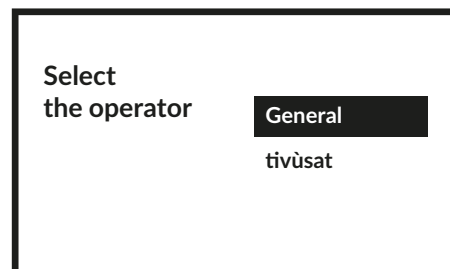

With **▲▼** you can select the satellite (or satellites) to which your dish is addressed. Press **OK** to access the submenu that allows you to activate or deactivate the selected satellite and to set its various parameters. After all settings have been made, select **NEXT** to continue.

NOTE: To configure the DiSEqC or Unicable parameters it is necessary to select More in the previous steps.

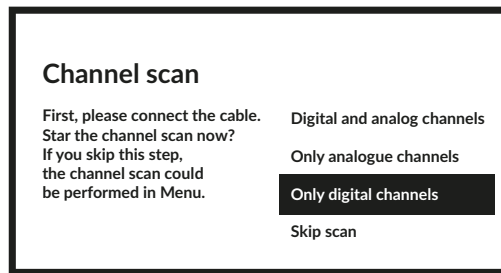

First step is to connect the satellite. Then you must start the channel scan. If you skip this step, the channel scan can be done later by accessing the TV menu. Press **OK** for your selection.

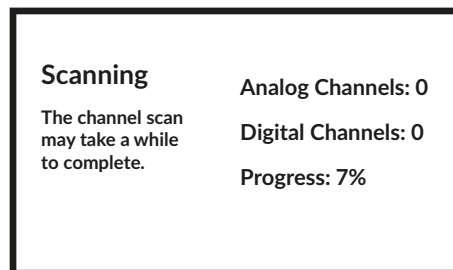

In the next step, the channel search is started and takes a few minutes.
Congratulations! You have successfully completed the First time installation of your TV.



4.0 HOME SCREEN

The Home screen is the main screen of this model of TV.

HOME SCREEN BASIC installation, with the possibility of accessing your account and the internet at a later time.

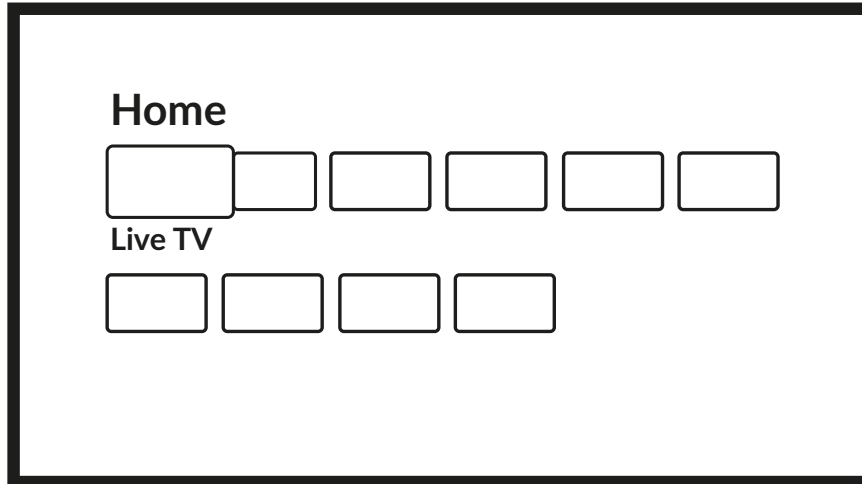

HOME SCREEN full installation:

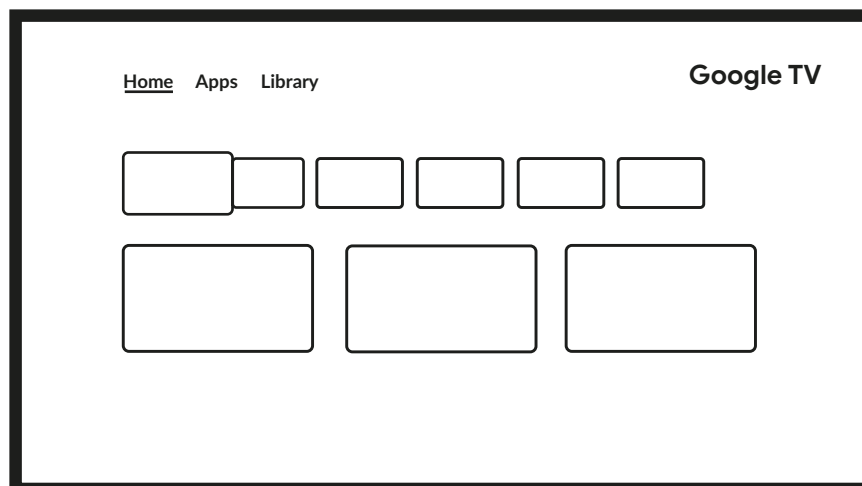

4.1 INPUTS

TV has such possible inputs or sources: *ATV, ANTENNA, CABLE* or *SATELLITE* for respective live TV installed channels preview or *HDMI 1, HDMI 2, HDMI 3* and *AV* to select connection from external devices.

To access to this option, select **Inputs** item on Home screen or press **INPUT** button on RCU. Select the input sources for the devices which are connected to the TV through the different inputs or ports.

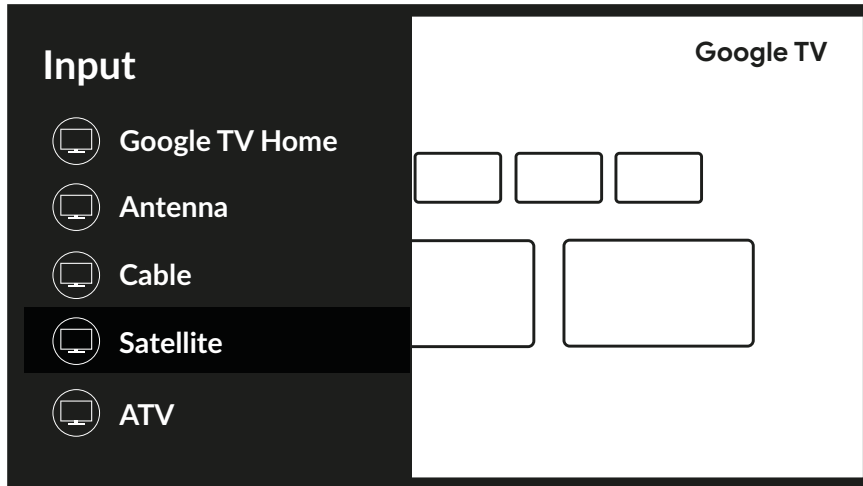

4.2 NETWORK & INTERNET

Connection to internet allows to install and use internet applications (i.e. You Tube, Netflix, etc.) and to enjoy of other advantages of Smart TV.

Access to the part for network and internet connection is through chapter *Network & internet* of *Settings* menu or through quick access panel on Home screen.

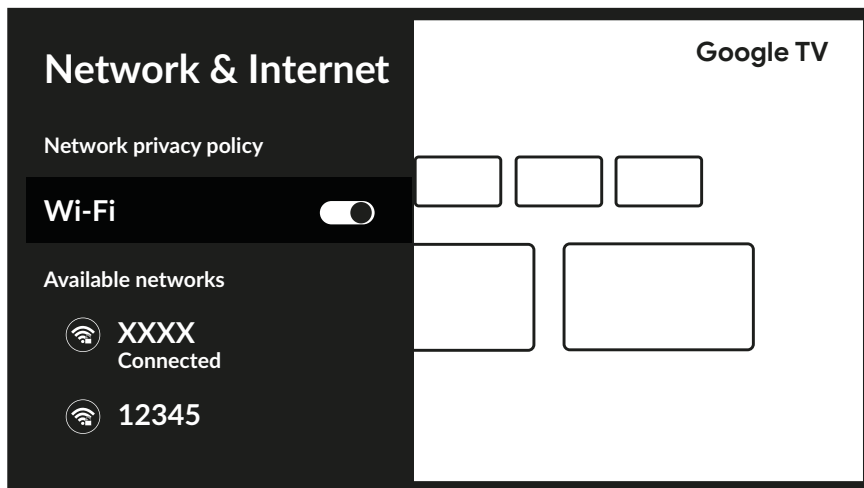

Your TV can be connected to your home network in two ways:

- Wired, using the RJ-45 (LAN) connector on the back panel.
- Wireless, using the internal wireless and your home wireless network.

NOTE: To access the Internet, you must subscribe to a highspeed broadband Internet service with your Internet service provider.

NOTE: Instructions below are just the usual ways to connect your TV to a wired or wireless network. The connection method may differ depending on your actual network configuration. If you have any questions about your home network, please refer to your Internet service provider.

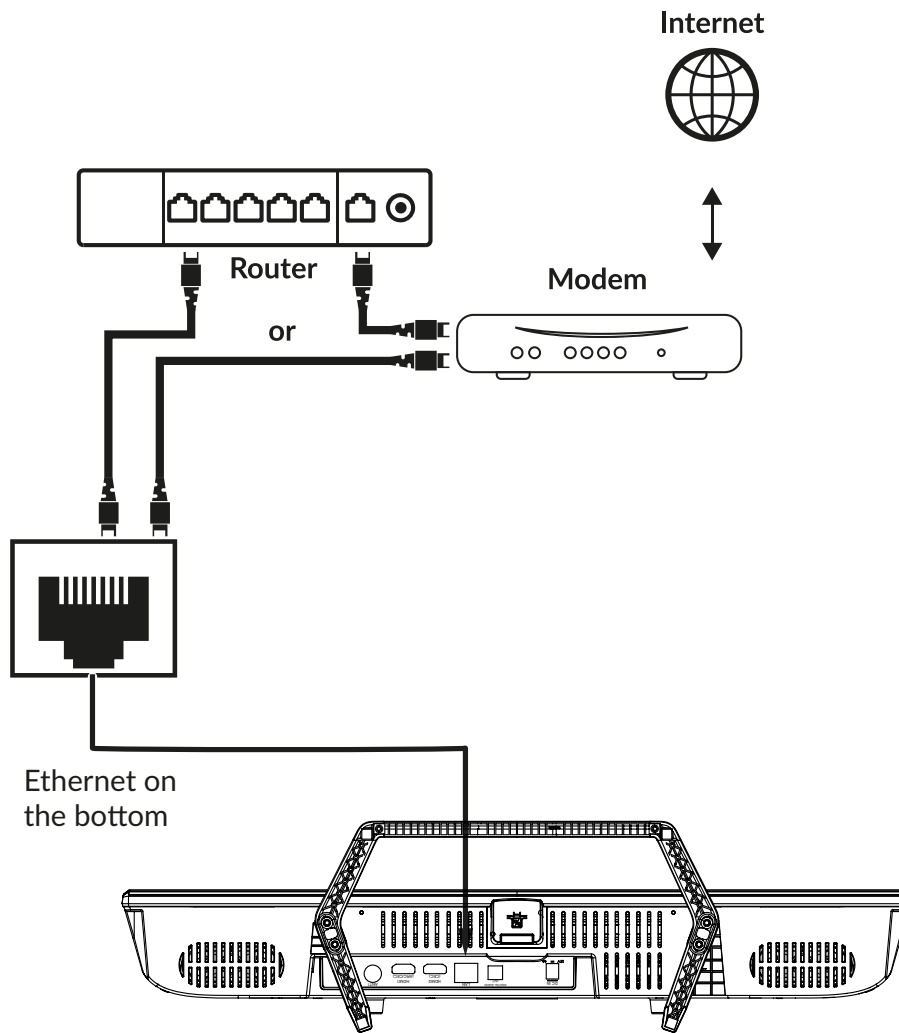

NOTE: The graphics are for representation only.

To connect to a wired network

1. Ensure you have:

- An Ethernet cable long enough to reach your TV
- A router or modem with an available Ethernet port
- A highspeed Internet connection

2. Connect your Ethernet cable to the router and to the Ethernet port on the back of the TV.

3. Use the *Network Configuration* menu to configure the TV.

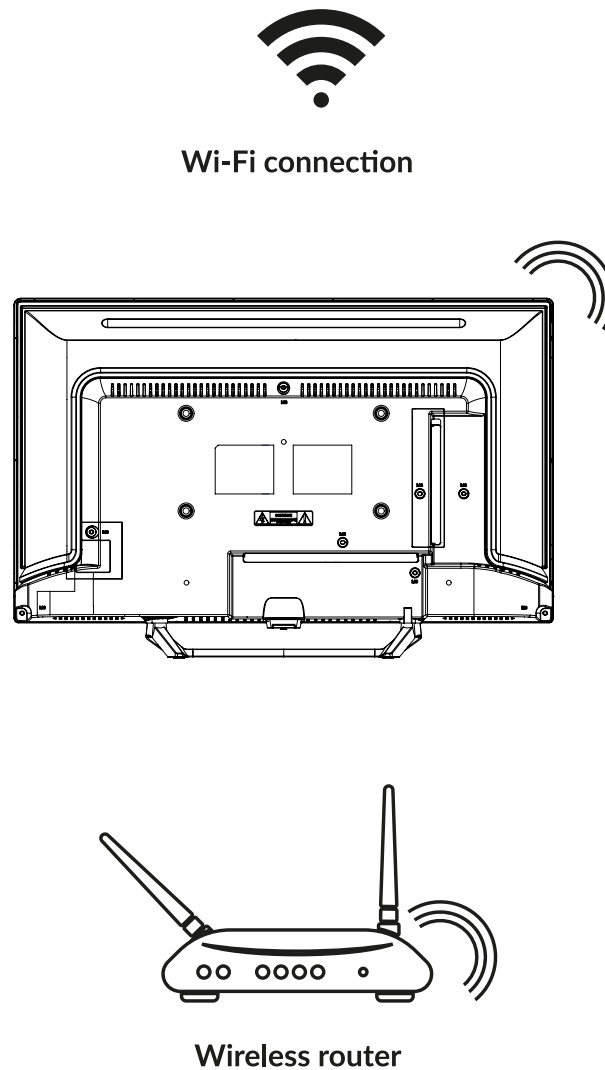

NOTE: The graphics are for representation only.

To connect to a wireless network:

1. Ensure you have:
 - A router broadcasting a 2.4GHz or 5GHz wireless signal.
 - A highspeed Internet connection
2. Select your Wi-Fi network from the *Available networks* list and enter password for connection.
3. Use other options of menu to configure the connection (if required).

Please refer to **chapter 6** to read more about Smart features of your TV.

5.0 LIVE TV USAGE

Select *Live TV* application from Home screen or one of TV sources from input menu to watch live TV channels. Press **OK** to start this application.

This application gives you access to live TV to watch and enjoy your favorite TV and radio programs from TV sources (ATV, Antenna, Cable or several of Satellites) of your choice.

In case if you skipped channel installation part during FTI and enter application for the first time, application will recommend to perform channel scanning and installation.

NOTE: Please note, that you can't watch anything, if there are no channels scanned and installed.

5.1 CHANNEL INSTALLATION

If the channels were not tuned during the first installation, it is still possible to do so later, by accessing the **LIVE TV** application available on the HOME screen.

First of all you need to select the correct source to scan to get the channels you intend to install by pressing the **≡** button and selecting a source.

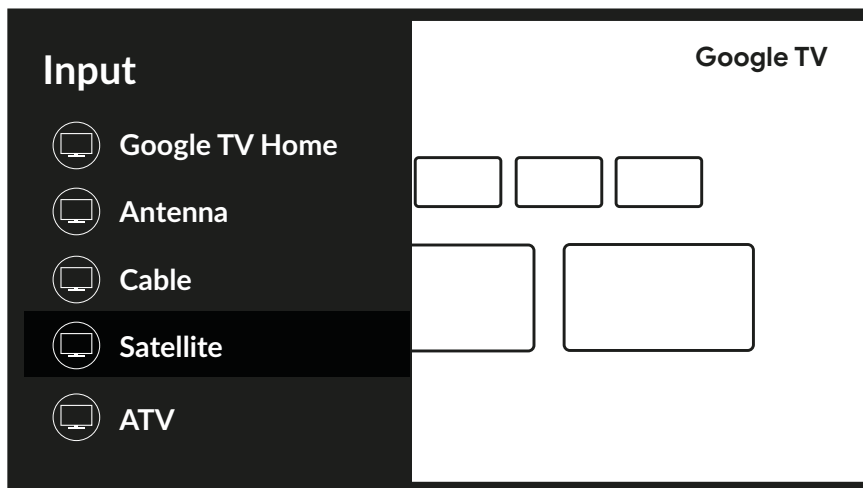

Once set the correct source press **≡** then **▲** button to get to *Channels* chapter. Select *Channel* and follow the instructions for the channels installation.

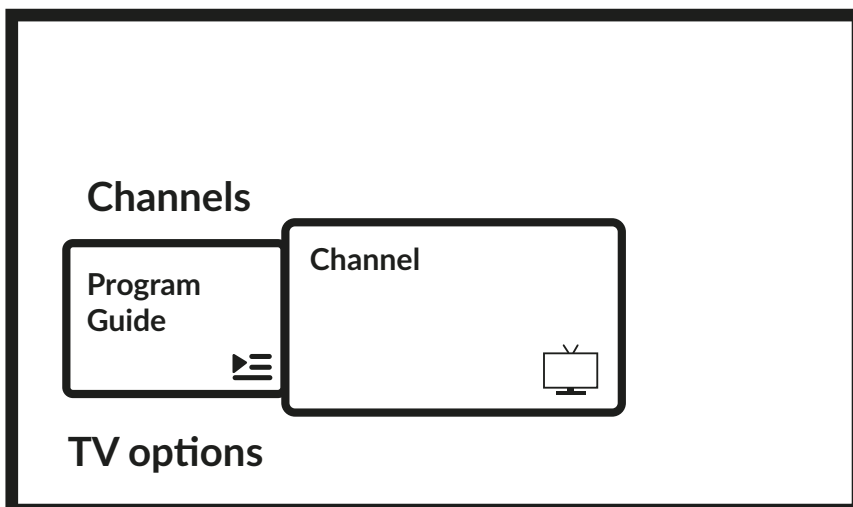

5.2 WATCHING TV CHANNELS

When the installation is completed, you can use TV set for watching of installed TV programs. Some helpful features for comfortable watching.

Changing channels

Following ways are possible for changing channels:



- Via direct access using the 0~9 buttons.
- Via the ▲▼ or P+/P- buttons.
- Via the channel list using OK and ▲▼ buttons. Use P+/P- or ◀▶ buttons in the list to move through list Page Up or Down.

Info Banner

While watching TV you can press INFO button to get information about current / next program and event on broadcasting and also some other useful information about it*.

*Event information is displayed when available. Availability depends on the broadcast.

5.3 ELECTRONIC PROGRAM GUIDE (EPG)

EPG stands for Digital Electronic Program Guide. It is supplied by the programme providers and offers information about broadcasted programmes. You can access it in digital mode by pressing  on the remote control or through TV options with  + ▲ button in Channels chapter. Select Program Guide icon to get into EPG.

Use ▲▼ to select channel and ◀▶ to see detailed information for program.

Press ← to stop and return to viewing modes.



Press COLOUR buttons to make required actions:

RED	jump to Previous Day of EPG
GREEN	jump to Next Day of EPG
YELLOW	Display details
BLUE	Type Filter

NOTE: Vertical line in time bar shows current time. Selected program has progress bar in different colour, which shows how much time passed from the beginning of the program.

5.4 TV MENUS

You can use access to menus of Live TV application to make changes in channels viewing and set other options.

It has 2 levels Channels and TV options (default). This menu organized as lines of icons. To display the TV options menu press  button, to display Channels menu press  and ▲ buttons.

1st TV options level

This level called Channels and gives access to some information and parameters of broadcasting.

It contains such items: Program Guide, Channel and Channel Management.

Program Guide

gives access to EPG. Please refer to **Chapter 5.3** for more information how to use it.

Channel

tool allows you to search for channels (please refer to Chapter 5.1) and modify the Parental Control settings.

Channel Management

gives access to a series of options that allow you to modify the channel list. For example, it allows you to delete, skip or reposition one or more channels contained in the list.

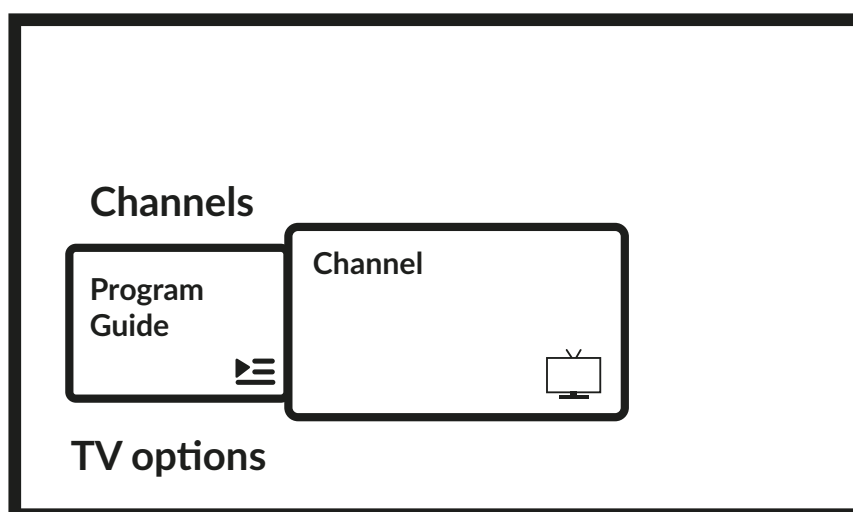

2nd TV options level

TV options contains such items: *Input, Picture, Screen, Sound, Power, Parental Controls, CI Card, Advanced Options and Settings.*

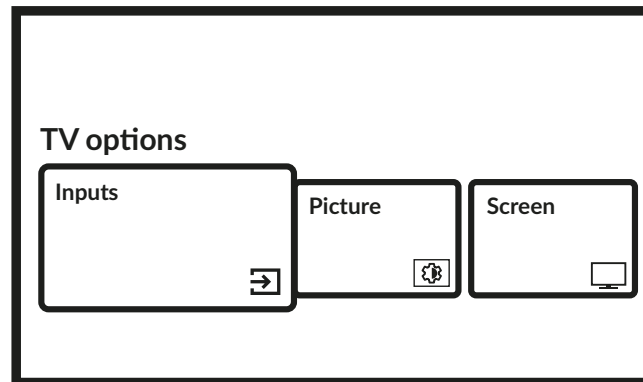

Inputs allows you to select the source to be displayed. The available sources are:

- Antenna: to enable the display of channels from the digital terrestrial signal.
- Cable: to enable viewing of channels from the cable signal.
- Satellite: to enable viewing of channels from satellite signal.
- ATV: to enable the display of channels from the analog terrestrial signal.
- AV: to display the audio/video signal from the AV input.
- HDMI 1: to view the signal coming from HDMI 1 input.
- HDMI 2: to view the signal coming from HDMI 2 input.
- HDMI 3: to view the signal coming from HDMI 3 input.
- Android TV Home: to return to Android Home Screen.

Pictures

allows you to modify the settings relating to the screen in all its parameters. It is also possible to set the various Picture Modes, to adapt the screen settings to the displayed program. The available settings are: *User, Standard, Vivid, Sport, Movie, Game, Energy Saving.*

Screen

allows you to modify the settings relating to the screen in all its parameters.

Sound

allows you to modify the settings relating to the Audio in all its parameters.

Power

allows you to change all settings related to device management such as the Sleep Timer or automatic Power-off in case of no signal.

Parental Control

allows you to set blocks or restrictions on programs if there are children using the TV. You can also change the PIN code of the TV.

CI Card:

if an CAM device is used, this option allows access to the main menu of the CAM or the Card connected to it.

Advanced Options:

allows you to manage among other things the primary and secondary audio language, subtitles, HbbTV and other settings and system information.

Settings:

it is the same menu that can also be reached from the Home screen and allows you to view or change network settings, accounts, device preferences and to connect other devices including the remote control via Bluetooth (for more information see chapter 7).

6.0 SMART TV POSSIBILITIES



Your TV model is smart. That is meaning that in addition to watching of normal Live TV, it provided some extra features, which allows you to use it in more flexible and wide way, to select other video content sources, like YouTube, Netflix, etc., to install various applications to extend functionality of your TV.

NOTE: Using of smart functionality of your TV require connection to internet and, in most cases, using your Google account. Please refer to **Chapter 3** and **Chapter 7** for information how to setup internet connection and enter to Google account.

Using Google account give you access to applications and games, movie and music market of Google Play Store. Here you could search, select and install some useful utilities or games, applications for IPTV content, for watching streaming video and music content, another player for Multimedia, receive actual weather information and other.

Quite often application required registration and using of unique account to get access to their services. Please note, that not all services are for free and require subscription fee. Please keep this information in private.

7.0 SYSTEM SETTINGS

Access all the main settings of your TV from the *Settings* menu through the  at the top right of the Home screen or by pressing the  button on the remote control.

7.1 SETTINGS MAIN MENU

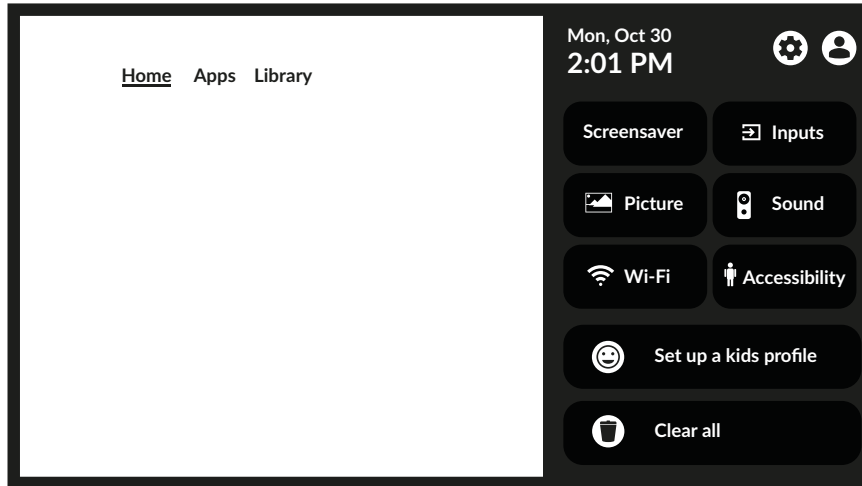

This first menu gives access to the most common settings, to access the complete menu select  and confirm with **OK**. In this menu it is possible to add, modify and manage your account (*Accounts & sign-in*), manage the network connection (*Network & internet*), applications (*Apps*), search channels or rename the inputs in (*Channels & Inputs*) or access sound and picture settings in (*Display & Sound*) and other important functions necessary for optimal use of the TV.

For *Network & internet* connections please refer to **Chapter 4.2**



It is possible to pair external devices such as audio speakers, headphones or a remote control to the TV using the Bluetooth technology. Selecting the *Remote & accessories* option starts the search function for devices to be paired. Before starting this function make sure that the device you intend to connect is also in search mode.

7.2 SYSTEM MENU

To get access to all device control options, like *Date & time*, *Language*, etc., please select *System* chapter on this menu.

Enter to main settings menu. Press   to select *System*, then press **OK** to enter the sub-menu.

Sub-menu content:

<p><i>Accessibility</i> <i>About</i></p> <p><i>Date & Time</i> <i>Language</i></p> <p><i>Keyboard</i> <i>Storage</i> <i>Ambient mode</i> <i>Power & Energy</i> <i>Cast</i></p> <p><i>System sound</i> <i>Retail Mode</i> <i>Restart</i></p>	<p>For managing subtitles or audio description. Provide information about your device model and name, some other useful information and also give access to tool of restart or update system.</p> <p>Define the way how to set local date and time, set format of this information, select local time zone. Display various languages list to set menu language for you TV. Use   to select required language and press OK to confirm.</p> <p>Set graphical on-screen keyboard parameters. information about internal and connected storage devices.</p> <p>Customize appearance of your screen saver.</p> <p>Contains various settings to optimize energy consumption.</p> <p>To connect your device with other Android devices connected to your Wi-Fi network and let them control media casting to your device.</p> <p>To enable or disable system sounds.</p> <p>To enable or disable the the shop mode that displays promotional messages.</p> <p>Select to restart the TV.</p>
---	--

8.0 MULTIMEDIA

8.1 REMINDER WHEN USING THE USB STORAGE DEVICES

1. Some USB storage devices may not be compatible to operate smoothly with this TV.
2. Back up all the data in the USB storage device in case data is lost due to an unexpected accident. STRONG does not assume any liability for the losses by misuse or malfunction. Data backup is consumer's responsibility.
3. For large file sizes, the loading speed may be slightly longer.
4. The recognition speed of a USB storage device may depend on each device.

5. When connecting or disconnecting the USB storage device, make sure the TV is not in USB mode, otherwise the USB storage device or the files stored in it may be damaged.
6. Please use only a USB storage device which is formatted in FAT16, FAT32, NTFS (playback only) file system provided with the Windows operating system. In case of a storage device formatted as a different utility programme which is not supported by Windows, it may not be recognized.
7. When using a USB Hard Disk Drive, which is not powered independently, ensure its power does not exceed 500 mA. Otherwise, the TV system will change into standby mode, and you must pull out the USB Hard Disk and restart the TV system.
8. An "Unsupported File" message will be displayed if the file format is unsupported or the file is corrupted.
9. FHD big picture needs longer time to process, which is not caused by the TV. Please be patient.
10. This TV may not support some Multimedia files changed and upgraded as the change of the encoding format or other technical aspects advances.

8.2 MULTIMEDIA PLAYER

In order to play multimedia files such as videos, films, music and photos from an external USB storage device, the use of the built-in Multimedia player is recommended. To access it, simply select the *Media Player* icon available on the Apps list on the Home Screen, it can also be accessed directly by pressing the **USB** button on the remote control.

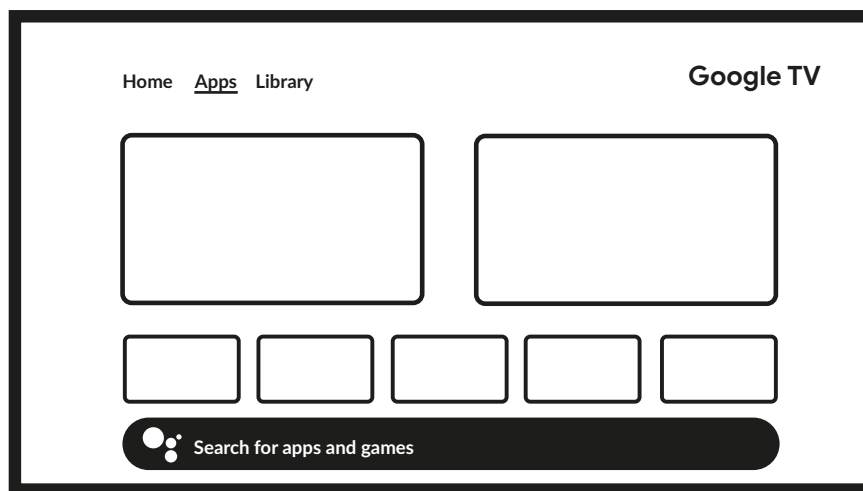

With Smart Player you can reproduce video, audio or picture files of supported formats from your USB storage devices on your TV screen.

NOTE: If, for any reason, you do not want to use built-in Smart Player application, you could enter to Google Play Store and install any of available media players (i.e. MX Player, VLC Player, etc.).

NOTE: Support (or non-support) of Multimedia files depend not only on your TV, but also on application, which will be used for playback. Different Multimedia applications could contain built-in abilities to support various formats and types of Multimedia files.

Connect a USB storage device to the USB port, run Smart Player and select the types of media on the Multimedia selection part of screen: *Video*, *Picture* or *Music*. In *Device* you can select the device containing the files to be played.

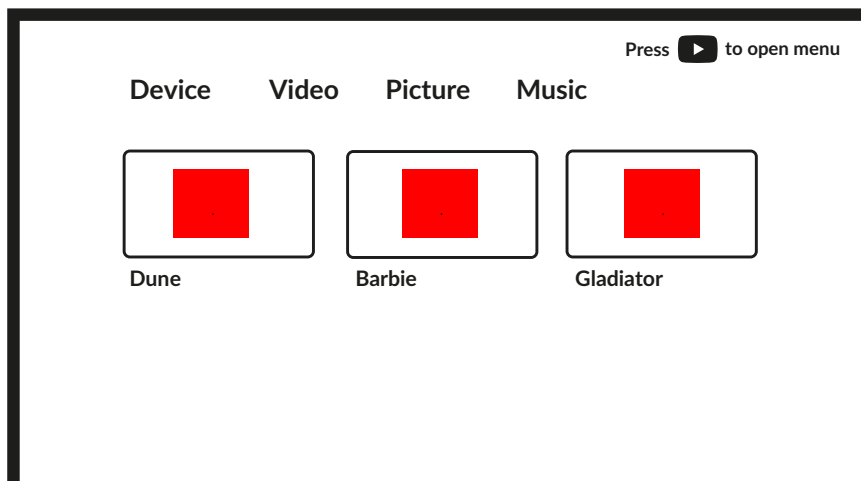

Your TV will collect all supported files of selected media type and will show them in one list.

Use ▲▼ and ◀▶ to select file.
Press OK for playback.

During playback you could use Multimedia buttons on your RCU or use on-screen commands, available from menu by ▲ button.

NOTE: By choosing one of the media types, for example Video, the list will display only compatible media files and no other files of other types.

TV remember files, which were opened earlier for playback, and show them as Playlist line.

8.2.1 PLAY VIDEOS

Select *Video* from Multimedia type selection and choose file for playback.

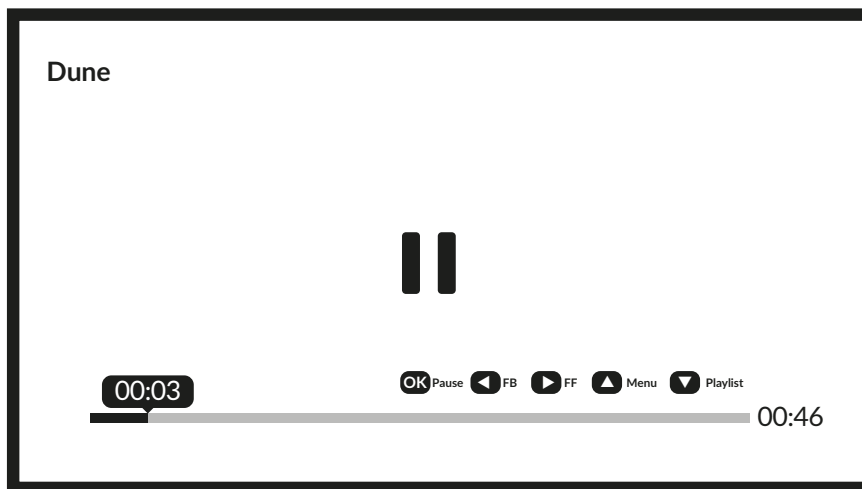

Additional useful keys:

OK to play or pause the playback.

◀▶ for rewind backward/forward the file.

▲ to access the Menu.

▼ to display the other video files present in the directory.

INFO button to get more information about the file.

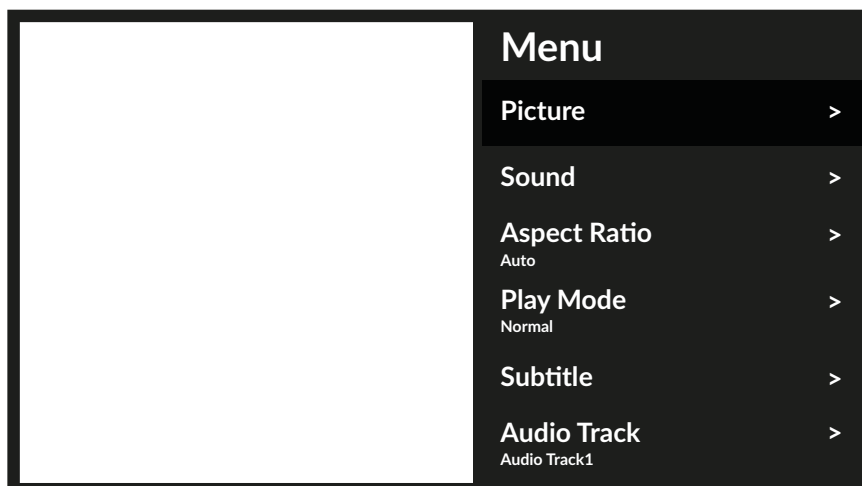

Available Menu options:

- Picture* gives access to all settings relating to the screen.
- Sound* gives access to all settings relating to audio.
- Aspect Ratio* this option allows you to adapt the video format to the screen.
- Play Mode* video file playback settings.
- Subtitle* to show subtitles on screen (if available).
- Audio Track* to select the audio track (if available).

8.2.2 BROWSE PHOTOS

Select *Photo* from Multimedia type selection and choose the file from which the slideshow has to start the playback.



To get access to control playback during playback press **OK** button to display the menu or **▼** button to display more content.

Available options:

- Rotation* to rotate picture on screen
- Play/Pause* to play or pause the slideshow playback
- Information* display detailed information about file
- Menu* access the menu to set the background music.

8.2.3 PLAY MUSIC

Select *Music* from Multimedia type selection and choose file for playback.

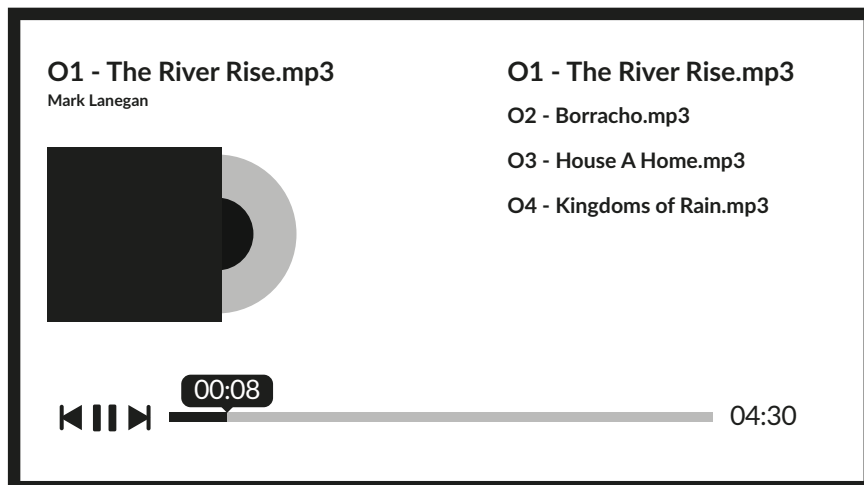

To control playback use on-screen or RCU Multimedia buttons.

NOTE: An over-modulated mp3 file may cause some sound distortion during playback.

8.2.4 BROWSE FILES

Select *Device* from Multimedia type selection and choose folder to enter or file for playback.

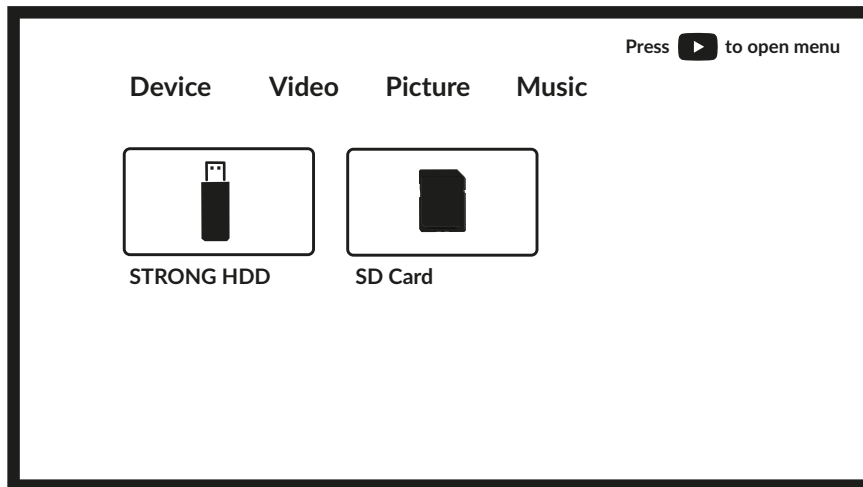

NOTE:

- This menu shows only supported by Smart Player files.
- Files with other file extensions may not be displayed, even if they are saved on the same USB storage device.

9.0 TROUBLESHOOTING

Before calling a service technician, review following information for possible causes and solutions for the problem you are experiencing. If the TV does not work properly after checking it, please contact your local service line or STRONG dealer. Alternatively, you can send a support mail via our website www.strong-eu.com.

Problem	Possible cause and solution
No picture, no sound	<ol style="list-style-type: none"> 1. Check if the fuse or circuit breaker is working. 2. Plug another electrical device into the outlet to make sure it is working or turned on. 3. The power plug is in bad contact with the outlet. 4. Check the signal source.
No colour	<ol style="list-style-type: none"> 1. Change the colour system. 2. Adjust the saturation. 3. Try another channel. Black-white programme may be received.
The remote control does not work	<ol style="list-style-type: none"> 1. Change the batteries. 2. The batteries are not installed correctly. 3. Main power is not connected.
No picture, normal sound	<ol style="list-style-type: none"> 1. Adjust the brightness and contrast. 2. Broadcasting failure may happen.
Normal picture, no sound	<ol style="list-style-type: none"> 1. Press the volume up button to increase the volume. 2. The volume is set to mute, press ⏏ to restore the sound. 3. Change the sound system. 4. Broadcasting failure may happen.
Unorderly ripples on the picture	It is usually caused by local interference, such as cars, daylight lamps and hair driers. Adjust the antenna to minimize the interference.

Problem	Possible cause and solution
Snowy dots, blocking and interference	<p>If the antenna is located in the fringe area of a television signal where the signal is weak, the picture may be marred by dots, show blocking or break-ups. When the signal is extremely weak, it may be necessary to install a special antenna to improve the reception.</p> <ol style="list-style-type: none"> 1. Adjust the position and orientation of the indoor/outdoor antenna. 2. Check the connection of the antenna. 3. Fine tune the channel. 4. Try another channel. Broadcasting failure may happen.
Ghost	<p>Ghosts are caused by the television signal following two paths. One is the direct path, the other is reflected from tall buildings, hills, or other objects. Changing the direction or position of the antenna may improve the reception.</p>
Radio frequency interference	<p>This interference produces moving ripples or diagonal streaks, and in some case, loss of contrast in the picture. Find out and remove the radio interference source.</p>
Playback of video is causing picture freeze/macro blocks or similar distortion, especially on HD content	<p>Read/write speed of your USB device could be too low. Make sure to use a USB storage device with sufficient speed and space. Pen drives (USB sticks) may not support sufficient speed.</p>
No signal or weak signal, intermittent reception	<ol style="list-style-type: none"> a) Cables might have loosened; moisture might have entered into cables or connectors, heavy rain at present or heavy storm at present. Check the cable connections, LNB and other equipment connected between the LNB and the receiver, or peak the dish. Wait for rain/storm to subside. Ask a local satellite specialist for advice. b) The satellite dish is not pointing at the (correct) satellite(s). Adjust the dish. Ask a local satellite specialist for advice. c) Satellite dish is too small, trees or buildings in path. Change to a larger dish or change position of dish. d) Signal is too strong, dish is oversized. Connect a signal attenuator to the LNB input. Ask a local satellite specialist for advice.
Bad picture / blocking error during heavy rain	<p>Heavy rain will attenuate satellite signals, below a certain level blocking will occur. Make sure your dish installation is up to standards to minimize rain effects. When in doubt, ask a local satellite specialist for advice.</p>
If the TV turns off after plugging a cable into any connector	<p>Again, turn on the TV.</p>

NOTE: If the problem persists after these solutions, please contact your local support centre or send a support mail via our website www.strong-eu.com.

10.0 SPECIFICATIONS

Audio

Audio Output: 2 x 2 W

Video

Channel coverage: DVB-T2: 174 MHz-230 MHz; 470 MHz-860 MHz
DVB-C: 113-858 MHz
DVB-S2: 950 MHz-2150 MHz
System: DTV: DVB-T2, DVB-S2, DVB-C
ATV: PAL/SECAM (BG/DK/1)
AV: PAL, NTSC, SECAM

Connectors

1x DC 12V (11.4 V ~ 12.6 V)
1x ANT/CABLE IN
1x SAT IN
1x CI
2x HDMI
1x USB
1x LAN (RJ-45)
1x S/PDIF (optical)
1x AV IN 3,5 mm
1x HEADPHONE

General Data

Operating voltage: 100 ~ 240 V AC 50/60 Hz
Power consumption: max. 45W / typ. 17W
Power consumption in standby: ≤ 0.5 W
Power adapter: 12V/4A
Operating temperature: +5 °C ~ +35 °C
Storage temperature: -15 °C ~ +45 °C
Operating humidity: 20% ~ 80% RH, non-condensing
Storage humidity: 10% ~ 90% RH, non-condensing
Dimensions (WxDxH) in mm (with stand): 552.9 x 147.8 x 369
Net-weight: 2.5 kg

Data Protection:

Please be aware that STRONG, its manufacturing partners, the application providers and the providers of the services may collect and use technical data and related information, including but not limited to technical information about this device, system and application software and peripherals. STRONG, its manufacturing partners, the application providers and the providers of the services may use such information to improve its products or to provide services or technologies to you, as long as it is in a form that does not personally identify you.

Additionally, please keep in mind that some services provided - already in the device or installed by you - may request a registration for which you have to provide personal data.

Besides that, please be aware that some services which are not pre-installed but can be installed may collect personal data even without providing additional warnings and that STRONG cannot be held liable for a possible breach of data protection by services not pre-installed.