

**Calling all  
attention-seekers.**



# LED POSTER DISPLAY

Led Digital Poster  
LED Banner



# LED POSTER DISPLAY

## Key Features



Integrate R&D, design, manufacturing, sales and service.



Smart Control & Multiple-unit Cascade



Unique design and stable performance



Wide Applicability, Indoor and Outdoor Models Available



Light Weight & Ultra-thin Frame



Fast Delivery, in stock ready for shipment



# LED POSTER DISPLAY



PC  
Screen6  
Screen1  
Input  
Output  
HDMI USB  
Power



Network

Input

Output

Audio

HDMI/USB

Switch

Power Plug

## Smart Control

- Synchronous & Asynchronous Dual-mode Media Player
- Real-time Zoom In And Out
  - 8 GB Memory
- Supports USB Expansion
- With HDMI Interface and Audio Port

# LED POSTER DISPLAY

## Installation Methods



Hanging

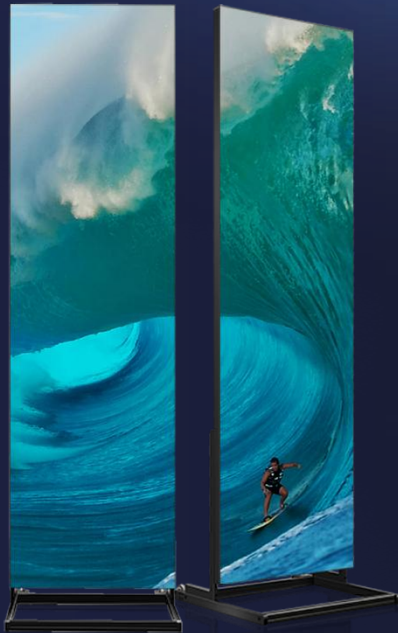

Free-Standing



Wall-Mounted

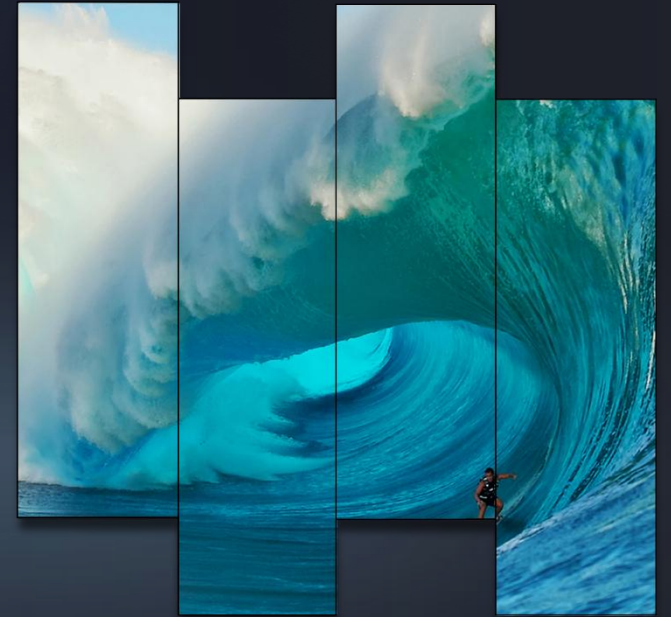

Creative Stitching

# LED POSTER DISPLAY

Play

To help consumer better use the product.  
We especially made a guide video for clients.  
The guide file will be sent with the Portable led poster.

Can automatically play video,  
pictures, text, and other programs.

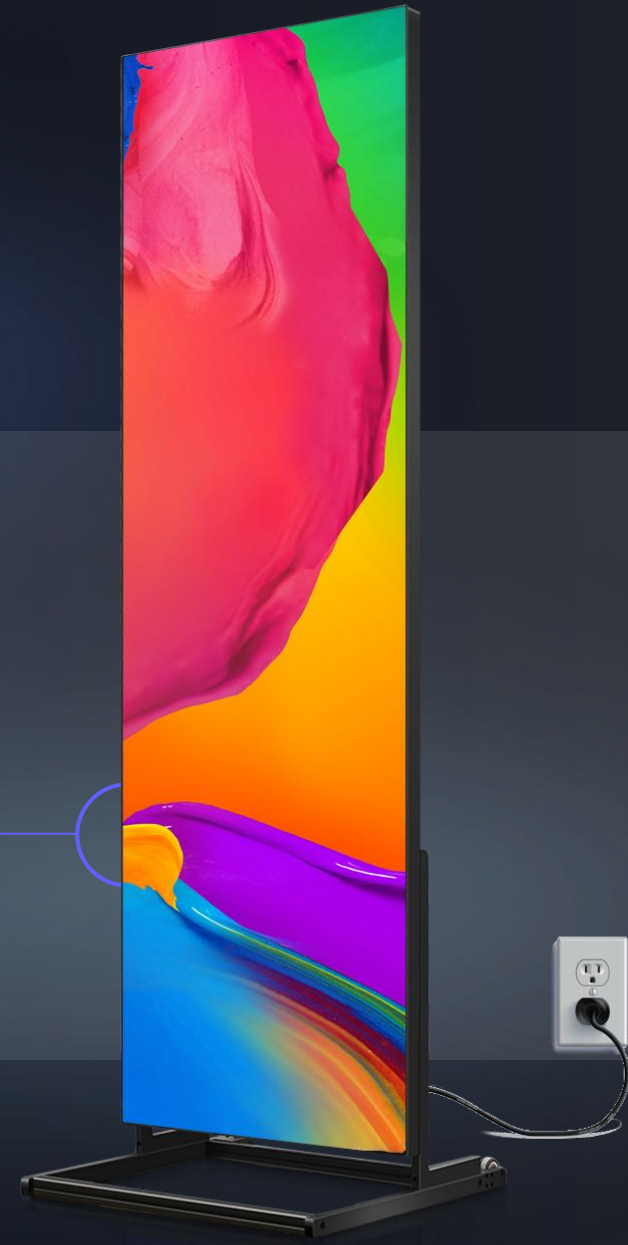

# LED POSTER DISPLAY

Light Weight & Ultra-Thin

Light Weight

 38 kg

Ultra-thin Frame

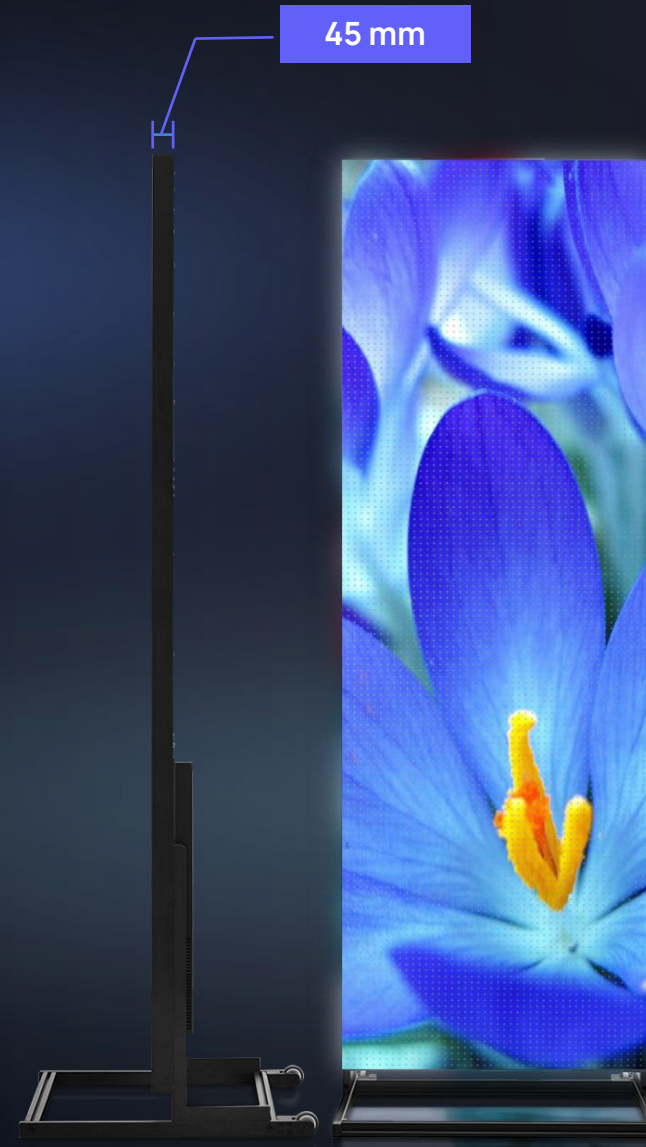
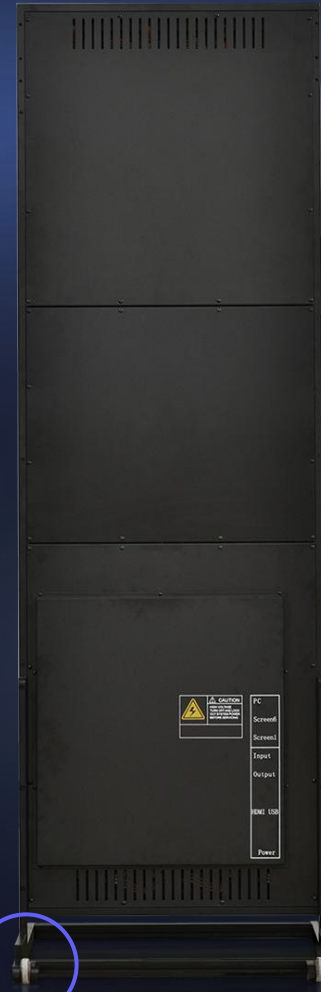
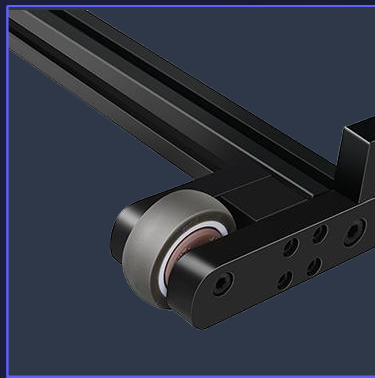

# LED POSTER DISPLAY

## APP Liability

### Indoor Digital LED Poster

- Shopping Malls
- Hospitals
- Hotels
- Restaurants
- Banks
- School
- Bars
- Exhibitions
- Stores
- Events



# LED POSTER DISPLAY

## Pixel Contrast

P3 Indoor Digital  
Led Poster

 35 kg

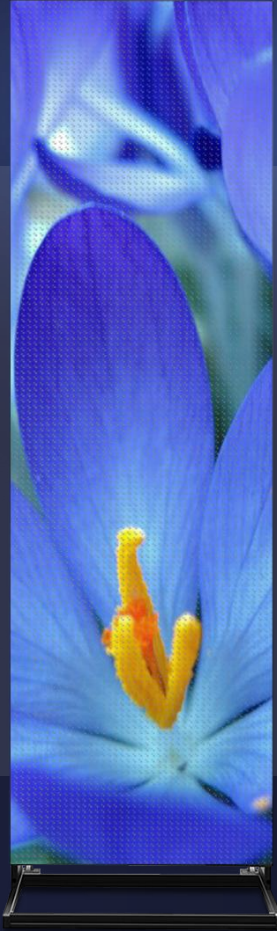

P2.5 Indoor Digital  
Led Poster

 38 kg

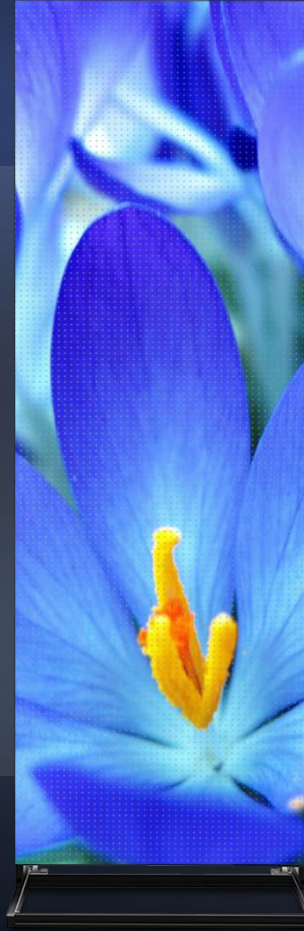

P2 Indoor Digital  
Led Poster

 46 kg

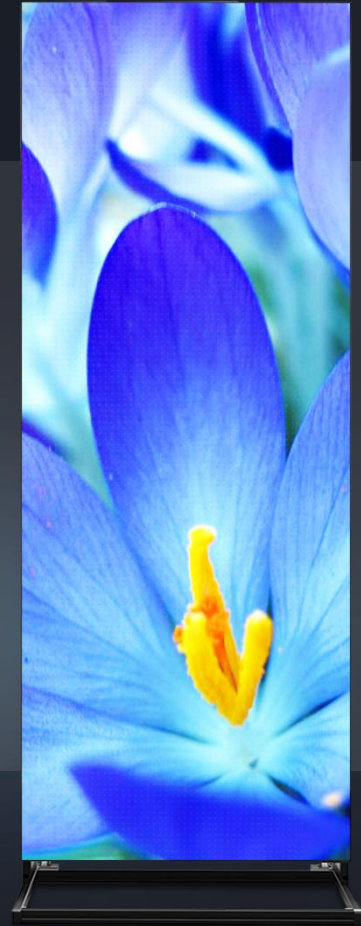

# LED POSTER DISPLAY

External Device  
Compatible

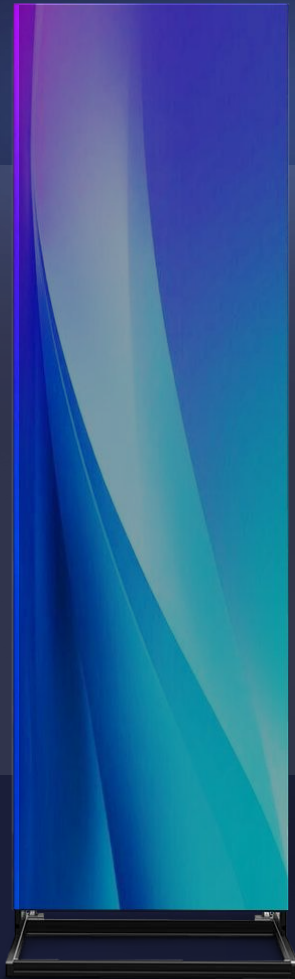

**Brightness Automatic  
Adjustment**



To achieve a better advertising effect, the digital LED poster can connect with the speaker. Not only this, the LED poster support interactive function (customizable).

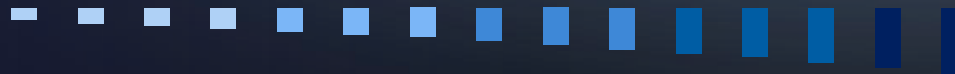

# LED POSTER DISPLAY

Outdoor  
Digital Led Display

Brightness 

Waterproof 



Indoor  
Digital Led Display

 Brightness



# LED POSTER DISPLAY



## Customization Service

Our hot-selling items are always in stock. So that customers don't have to wait for more than 10 days of production time.

We have freight forwarders that have cooperated for many years. So that when you inquire about freight, we can give the most cost-effective freight plan faster.

# LED POSTER DISPLAY

## Specifications

Model Type	DP2	DP2.5	DP3
Pixel pitch	2mm	2.5mm	3 mm
Destiny	250,000 dots /SQM	160,000 dots /SQM	111,111 dots /SQM
LED Type	SMD1515 Mat Black	SMD 2121 Mat Black	SMD 2121 Mat Black
Pixel type(R / G / B)	1R1G1B (3 in 1)	1R1G1B (3 in 1)	1R1G1B (3 in 1)
Module size	256 x 128mm	160 x 160mm	192 x 192mm
Module Resolution	128*64pixel	64*64pixel	64*64 pixel
Screen Size (H*W)	768*1920mm	640*1920mm	576*1920mm
Feet Size	2.52 * 6.3 feet	2.10* 6.3 feet	1.88 * 6.3 feet
Screen Resolution	384 * 960 pixel	256 * 768 pixel	192 * 640 pixel
Frame Size	1930mm(H)*776mm(W)*45mm(T)	1930mm(H)*648mm(W)*45mm(T)	1930mm(H)*584mm(W)*45mm(T)
Case Material	Aluminum	Aluminum	Aluminum
Weight	46kg/ unit	38kg/ unit	35kg/ unit

# LED POSTER DISPLAY

## Specifications

Model Type	DP2	DP2.5	DP3
Viewing Distance	≥ 2 M	≥ 2.5 M	≥ 3 M
Brightness	≥ 1,000 cd/m <sup>2</sup>	≥ 1,000 cd/m <sup>2</sup>	≥ 1,000 cd/m <sup>2</sup>
Viewing Angle	140° (H)/140°(V)	140° (H)/140°(V)	140° (H)/140°(V)
Refresh rate	≥1,920 Hz (3840HZ optional)	≥1,920 Hz (3840HZ optional)	≥1,920 Hz (3840HZ optional)
Input voltage	AC90-240V	AC90-240V	AC90-240V
Maximum Power Consumption	1170Wper unit	750Wper unit	600W per unit
Average Power Consumption	350Wper unit	220Wper unit	280W per unit
Control method	Asynchronous(WIFI/USB/LAN/HDMI)	Asynchronous (WIFI/USB/LAN/HDMI)	Asynchronous (WIFI/USB/LAN/HDMI)
Temperature Operating (°C)	-40°~+75°	-40°~+75°	-40°~+75°
Working Humidity	10%–95%RH	10%–95%RH	10%–95%RH
IP Rating	IP20	IP20	IP20
Application	Indoor/ Semi-Outdoor	Indoor/ Semi-Outdoor	Indoor/ Semi-Outdoor

# 75"

Technical Drawing

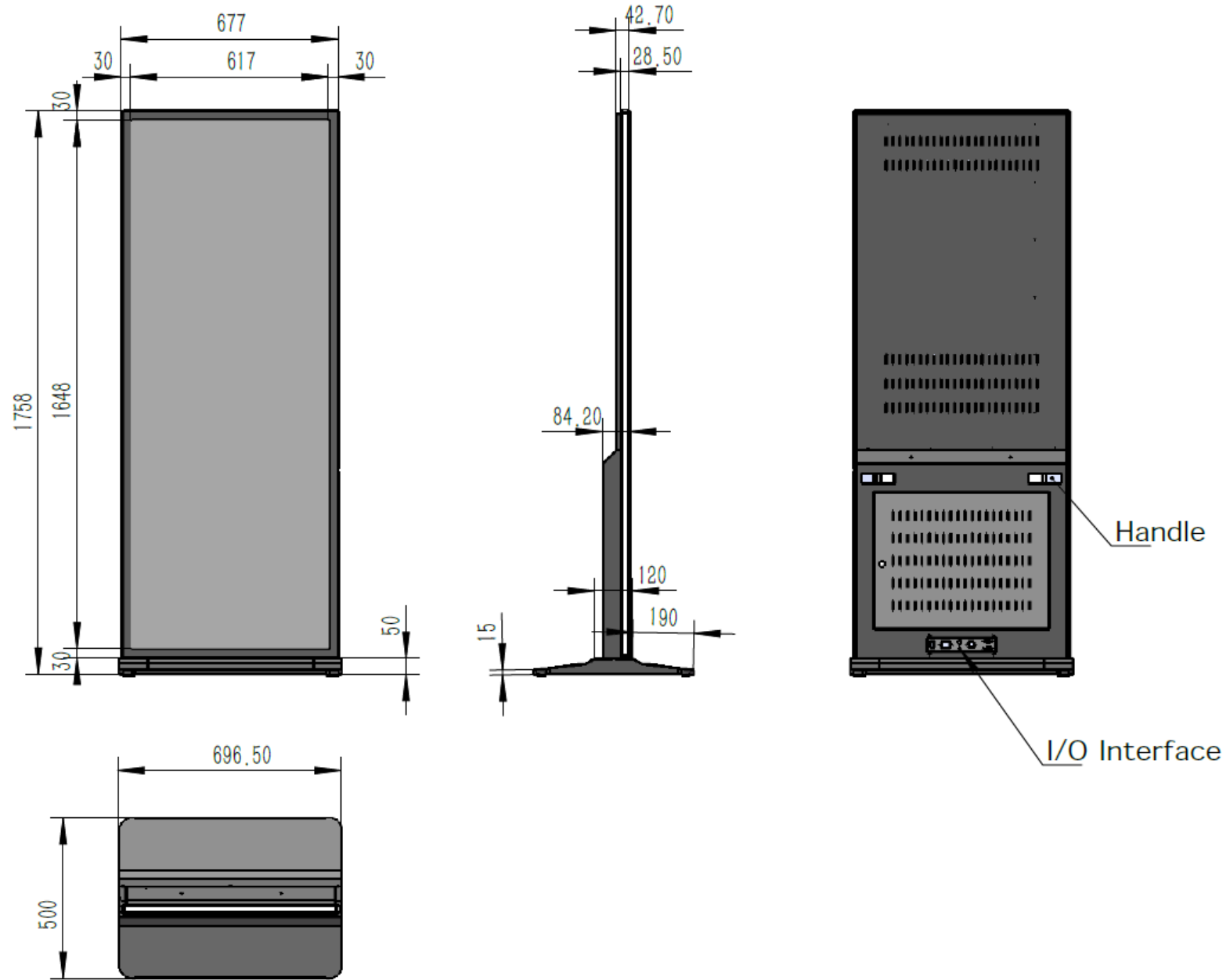

# 86"

## Technical Drawing

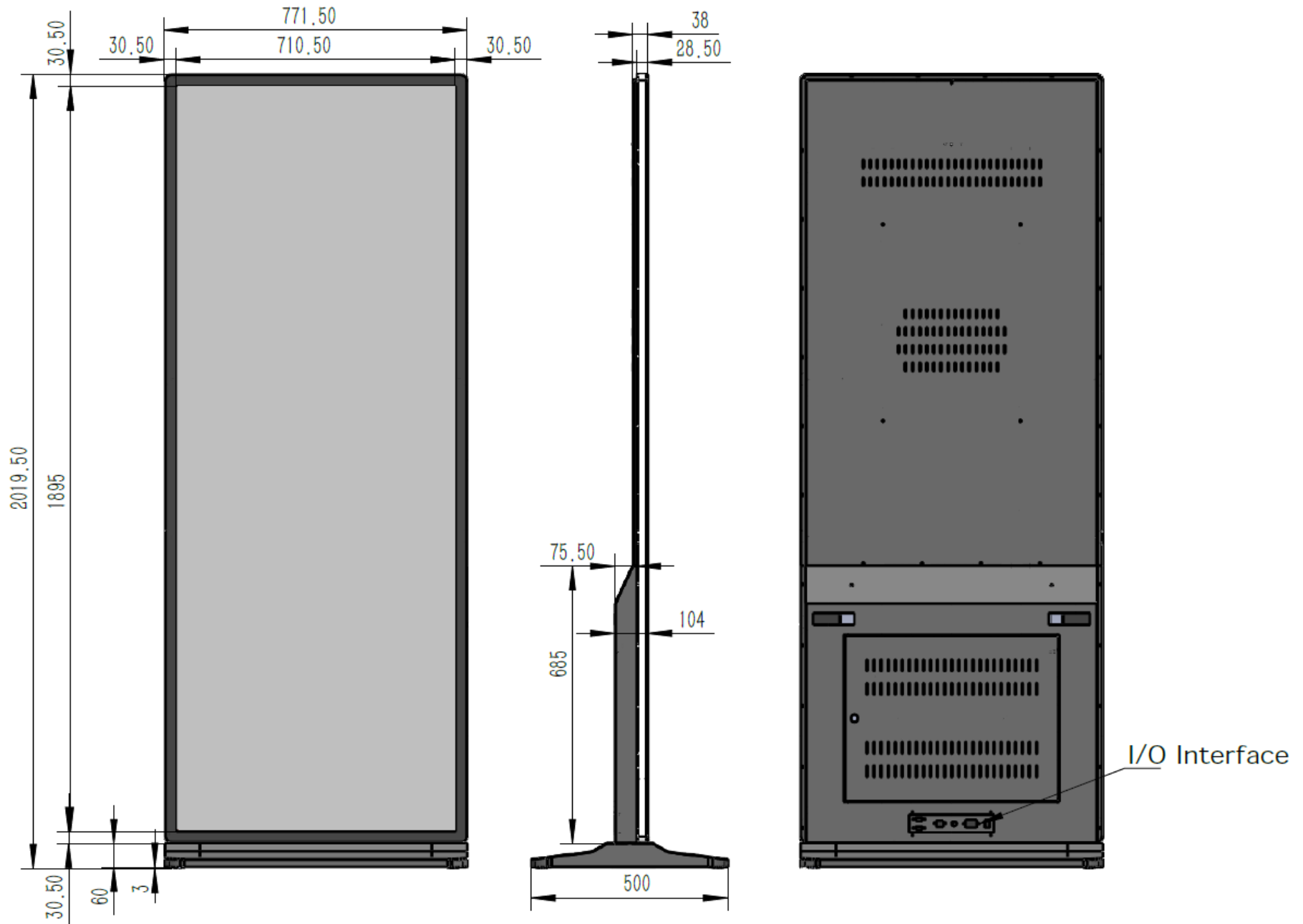

**We look forward to  
working with you soon.**



1300 125 635 

sales@onq.digital 

Level 10, 650 Chapel Street, South Yarra VIC 3141 