

PRODUCT: Q2-ORION-L

WEIGHT: 415 lbs.
(CUSTOMER TO OFFLOAD IF OVER 6000 Lbs.)

Authorized Signature _____

Date _____

CONCRETE COLOR:

- NATURAL
- MISSION WHITE
- CUSTOM: _____
- FRENCH GREY
- LATTE

CONCRETE TEXTURE:

- CRAFTSMANS ETCH
- STRATA
- HONED

QUANTITY: _____

SEALER: PERMASHIELD 4200 SEALER

By signing above or stamping this drawing "approved" or "no exception taken" authorization is give to QCP to produce this drawing as shown within a 1/4" tolerance.

GENERAL PRODUCT NOTES:
E = EXPOSED FINISHED SURFACE
INSTALLATION IS REQUIRED BY OTHERS.
ALL EDGES TO BE EASED.
MANUFACTURING TOLERANCE ±1/4".
ANCHORING METHOD BY OTHERS

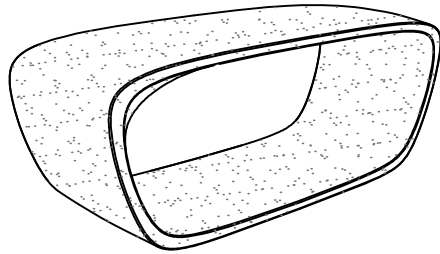

ISOMETRIC VIEW

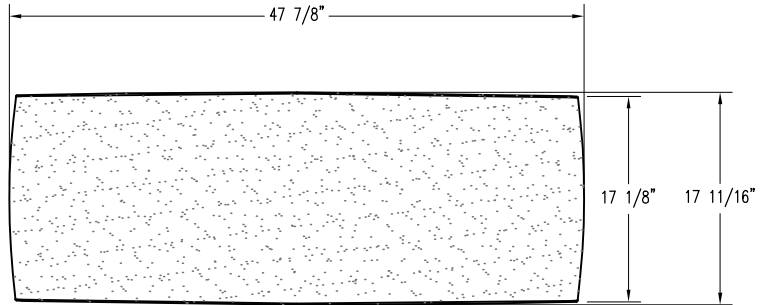

PLAN VIEW

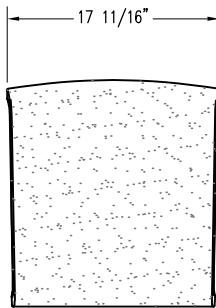

SIDE VIEW

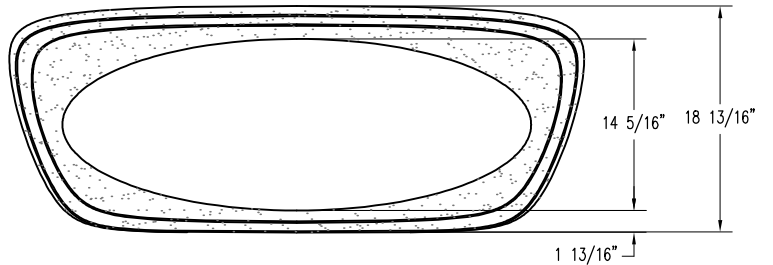

ELEVATION VIEW

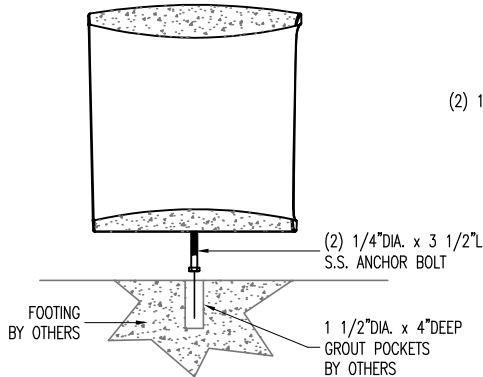

SECTION VIEW

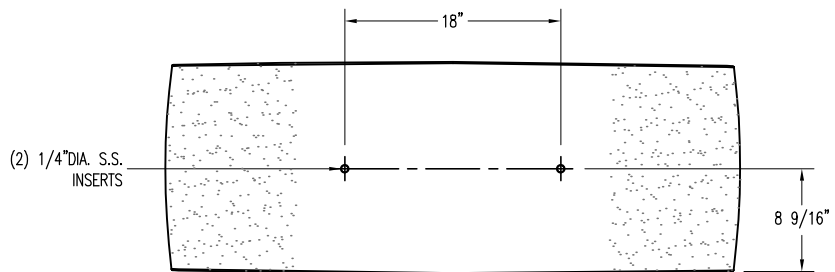

BOTTOM VIEW

HARDWARE LIST	
QTY	TYPE
2	1/4" DIA. x 3 1/2" L. S.S. ANCHOR BOLT

 www.qcp-corp.com	PLAN TYPE	CONSTRUCTION PLAN	DATE	3/10/26	FILE NO.	Q2-ORION-L	SHEET
	PRODUCT	Q2-ORION-L SEATING ORION	SCALE	0'-0 3/4" = 1'	DRAWN BY:	----	OF
	PROJECT NAME		PC. NO.		QC ITEM NO.		