

ARTEMIS: Rosha 2"

Architectural Recessed Down Light (Wall Washer)

Rosha 2" Spotlights come in adjustable, adjustable tube, and wall washer format. Meeting for your needs, these down lights are made with quality aluminum, granting a Ingress Protection grading of IP 20.

Client:	
Order#:	
Project:	
Type:	

FEATURES

- Cold-forged aluminum radiator, twice heat dissipation of the die-cast aluminum
- COB LED Chip, deep hidden light source, multiple anti-glare
- Aluminum Reflector, Much better lighting distribution than plastic
- Fully metal made, good texture, high performance
- Comes in trim & trimless



PERFORMANCE DATA

Product ID	Body	Appearance	Wattage	Ingress Protection	CCT	CRI	Driver Voltage & Options
ROSHA-W	Wall Washer	Trim & Trimless	Max: 15W	IP20	2700K 3000K 3500K 4000K	90Ra	120-277Vac

ORDERING INFORMATION

ROSHA / W / / / / /
SERIES BODY APPEARANCE COLOR CCT WARRANTY

FIXTURE SERIES	
ROSHA	Rosha 2" Recessed Deco Downlight
BODY	
W	Wall Washer
APPEARANCE	
T	Trim
TL	Trimless
COLOR	
W	White
B	Black

CCT	
27K	2700K
30K	3000K
35K	3500K
40K	4000K
WARRANTY	
5	5 Year Warranty (included)
10	10 Year Warranty

2" Wall washer

Dia 2", strong cold-forged pure Alu. engine improves the Dlvd lumens up to 1344.7lm



ROSHA-W-T



ROSHA-W-TL

Wall Washer

H: 2.0m-3.0m

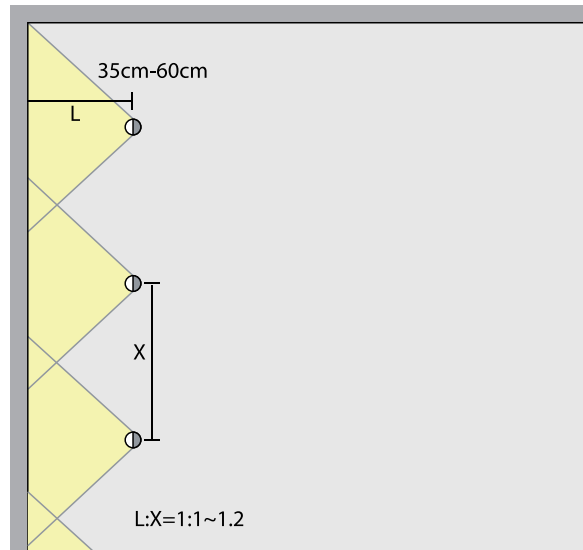
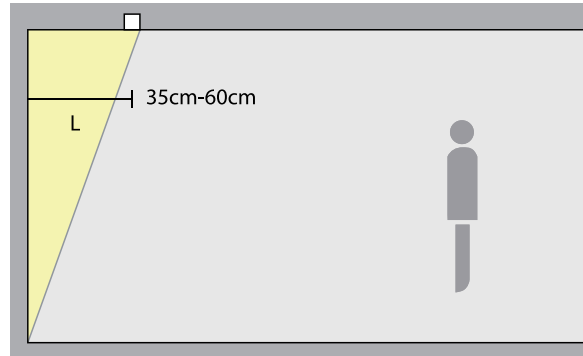



ROSHA-W-T



P. system	I (led)	Beam Angle	CCT	Lumens
15W	350mA	wall washer	2700K	1181.7 lm
			3000K	1234.2 lm
			4000K	1344.7 lm



Light Source	Input Voltage	CRI	UGR	Shielding Angle
LED COB	DC36V	90Ra	/	/

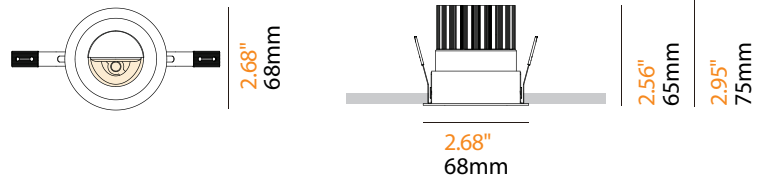
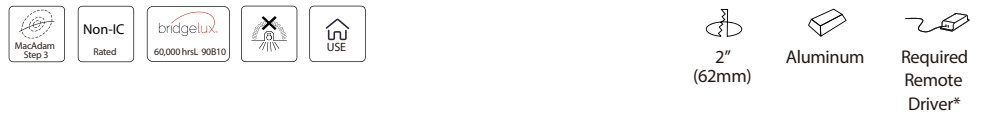

With Trim

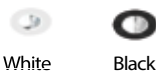

Driver: 120-277Vac ON-OFF | TRIAC | 0/1-10V | DALI

ROSHA-W-TL



P. system	I (led)	Beam Angle	CCT	Lumens
15W	350mA	wall washer	2700K	1181.7 lm
			3000K	1234.2 lm
			4000K	1344.7 lm



Light Source	Input Voltage	CRI	UGR	Shielding Angle
LED COB	DC36V	90Ra	/	/

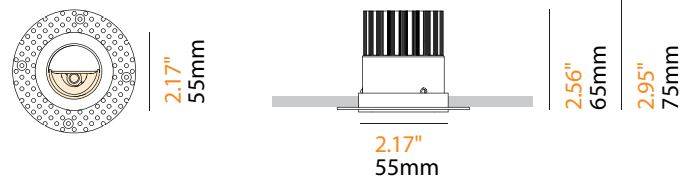

Trimless



Driver: 120-277Vac ON-OFF | TRIAC | 0/1-10V | DALI

Accessories

Drivers in Junction Box

CMEM55-XX
 TRIAC 6W, 8W, 10W, 15W
 XX = *Must specify wattage*

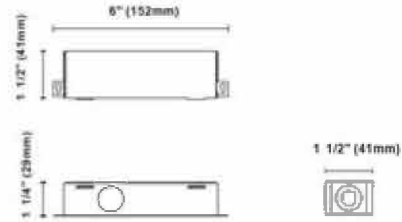

KIG-020-WDJ
 Triac/0-10V/1-10V LED DRIVER 10w/15w/17w/18w/20w 120-277V
 [250mA, 350mA, 400mA, 450mA, 500mA, 600mA, 700mA]

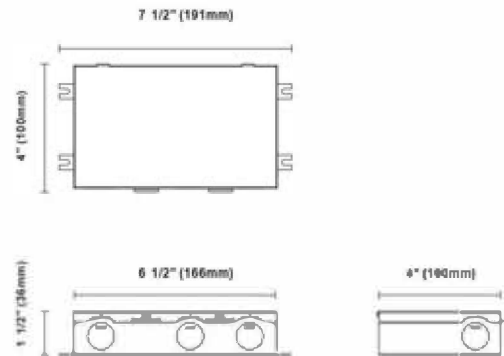

Brackets for New-Construction

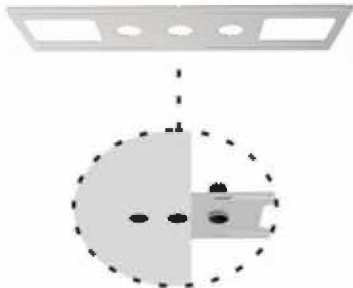

BRKT-3R45A

For Artemis trim & trimless
 Type: New construction plate

Cut out:

Round: Ø1" * 3(Ø50mm)

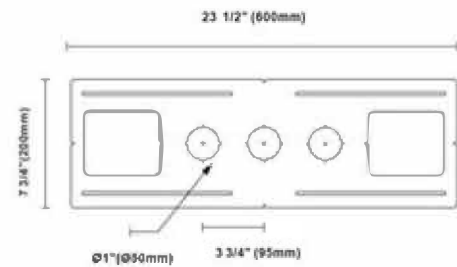

Remark

- Tailored brackets are available with a reasonable surcharge, details as below,
- The customized brackets' dimensions are still the same as the existing ones, 600*200mm
 - Hole sizes can be customized within the range of 25-100mm
 - Holes quantity can be indicated, 1-7pcs
 - Holes' positions on the bracket can be done as requests

Brackets for New-Construction (4-legs)

NCP-SR3-R21-XXX
 xxx = *must specify wattage*



Cut out:
 Round: Ø3" (Ø77mm)
 Ø2" (Ø62mm)
 Ø1" (Ø50mm)
 Square: □3" (□77mm)

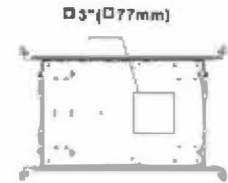
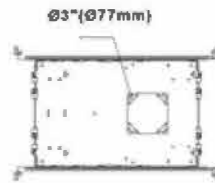
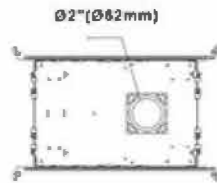
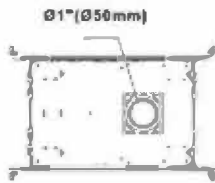
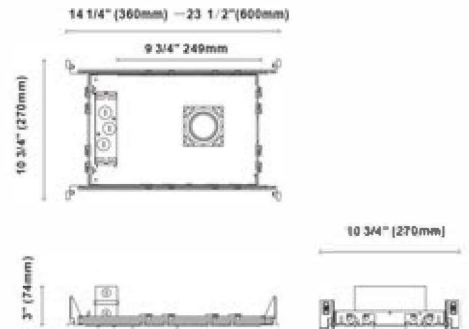

IC-Box for New-Construction (4-legs)

NCBX-SR3-R21-XXX
 xxx = *must specify wattage*



Cut out:
 Round: Ø3" (Ø77mm)
 Ø2" (Ø62mm)
 Ø1" (Ø50mm)
 Square: □3" (□77mm)

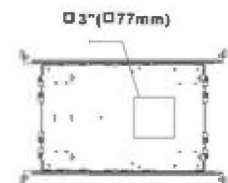
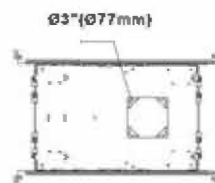
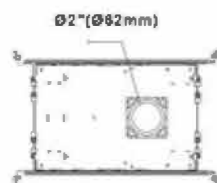
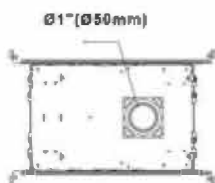
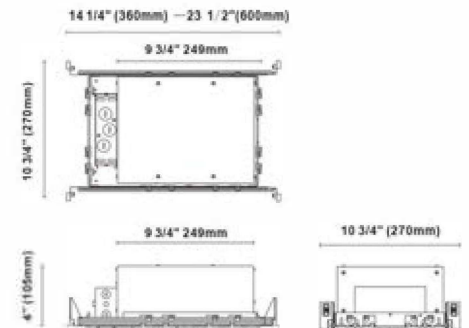

NON-IC Wire Diagram

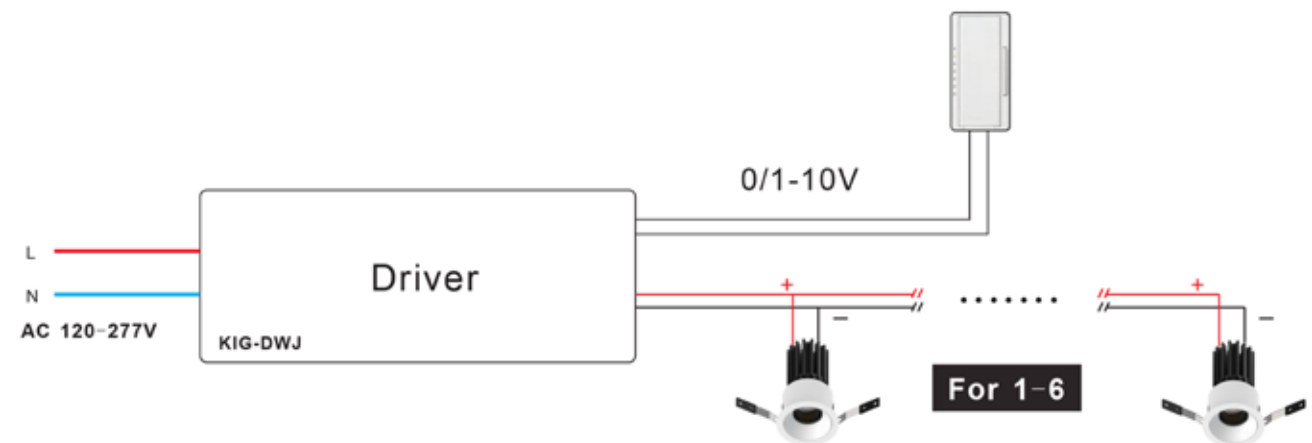
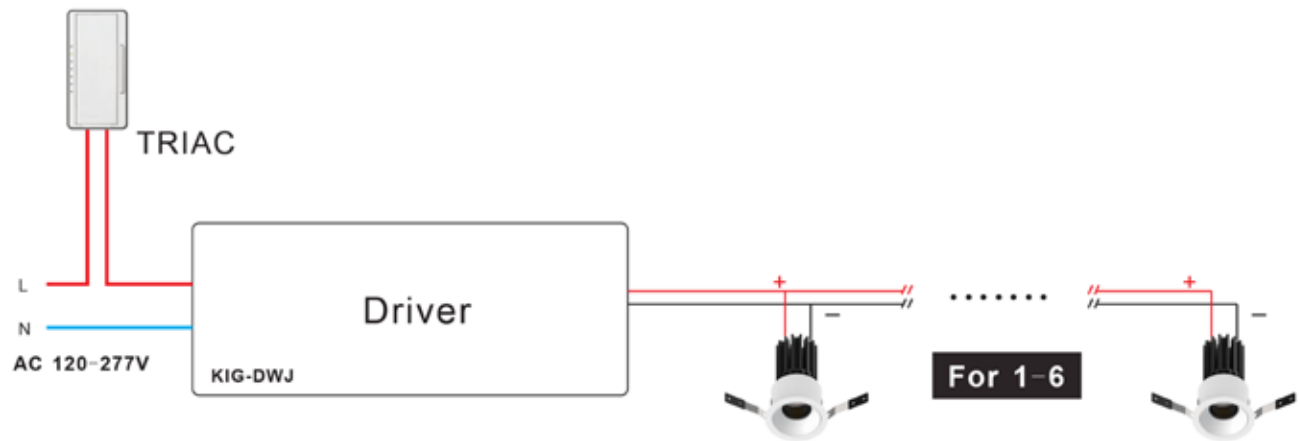
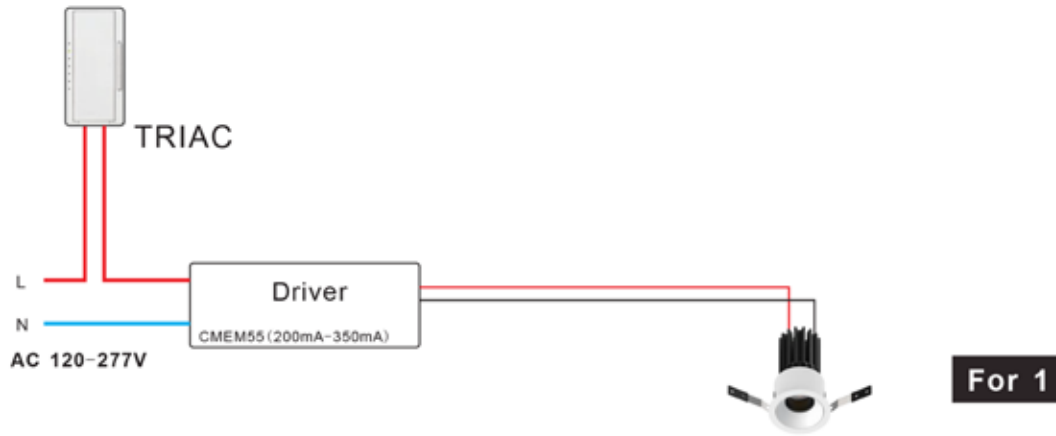

IC Rated Wire Diagram

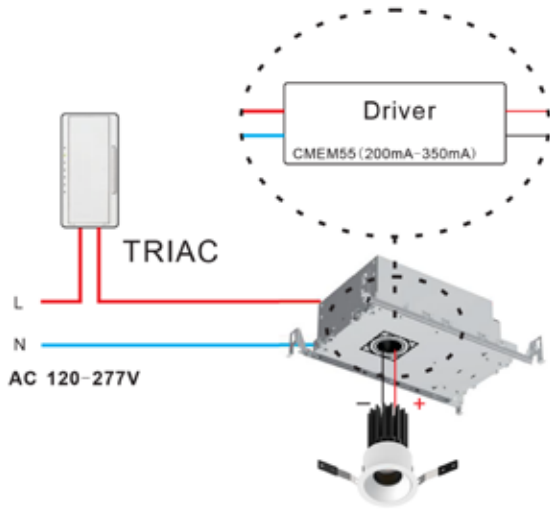

For 1

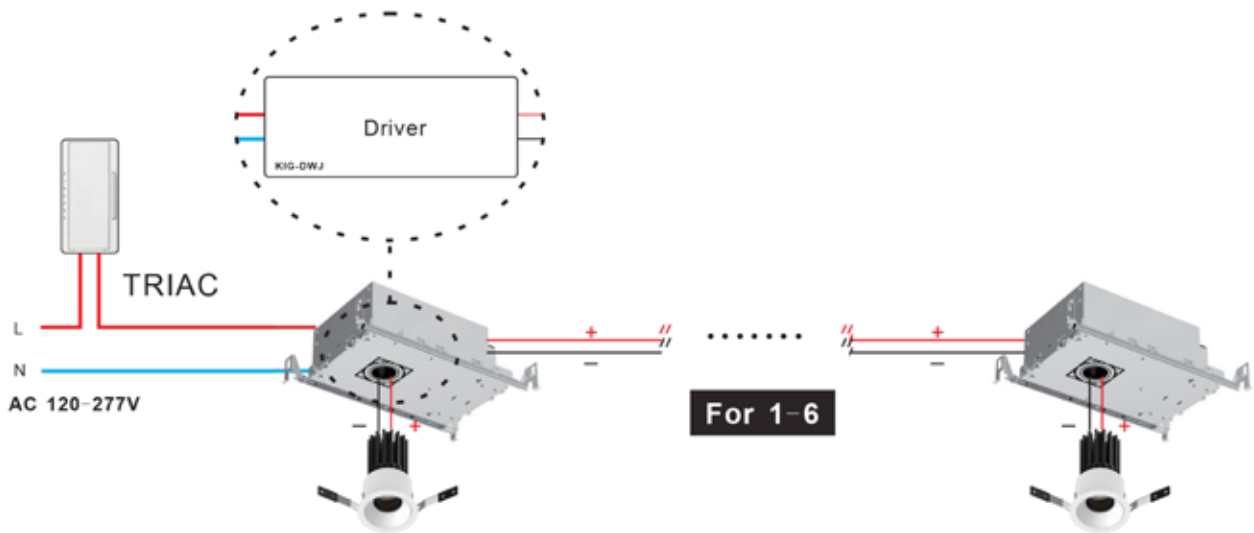

For 1-6

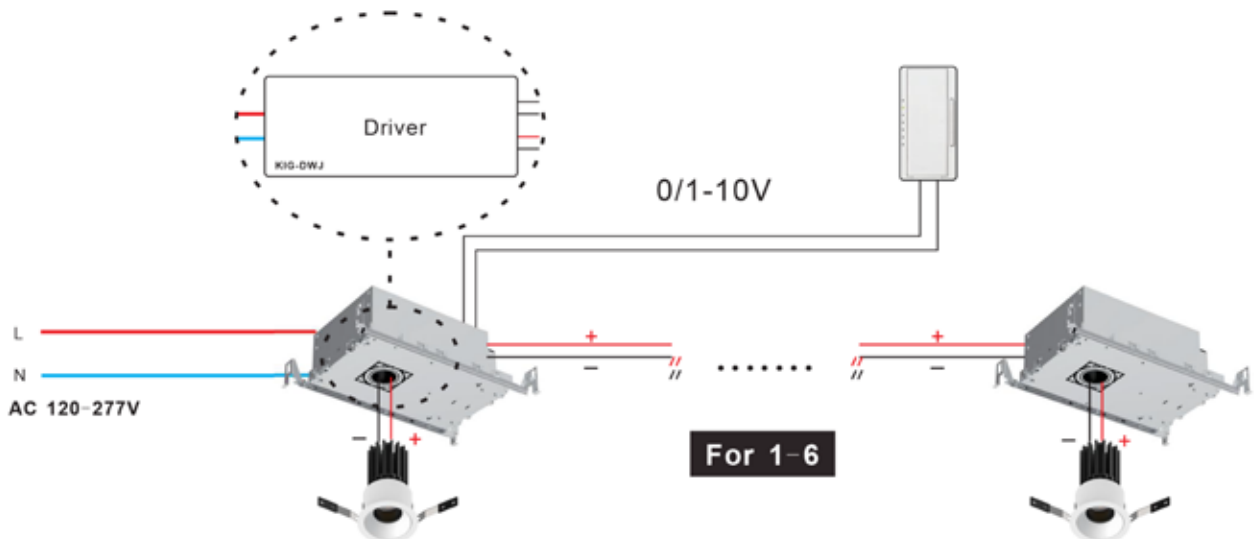

For 1-6