

ARTEMIS: Rosha 2 Square”

Architectural Recessed Down Light (Adjustable)

Rosha 2” Spotlights come in adjustable, adjustable tube, and wall washer format. Meeting for your needs, these down lights are made with quality aluminum, granting a Ingress Protection grading of IP 20.

Client:	
Order#:	
Project:	
Type:	

FEATURES

- Cold-forged aluminum radiator, twice heat dissipation of the die-cast aluminum
- COB LED Chip, deep hidden light source, multiple anti-glare
- Aluminum Reflector, Much better lighting distribution than plastic
- Fully metal made, good texture, high performance
- Comes in trim & trimless



PERFORMANCE DATA



Product ID	Body	Appearance	Wattage	Ingress Protection	Beam Angle	CCT	CRI	Driver Voltage & Options
ROSHA-SA	Square Adjustable	Trim & Trimless	Max: 15W	IP20	15° 25° 35° 50°	2700K 3000K 3500K 4000K Dim to Warm 2700-1800K 3000-1800K	90Ra	120-277Vac

ORDERING INFORMATION

ROSHA / SA / _____ / _____ / _____ / _____ / _____
 SERIES BODY APPEARANCE REFLECTOR COLOR CCT BEAM ANGLE WARRANTY

FIXTURE SERIES	
ROSHA	Rosha 2” Recessed Deco Downlight
BODY	
SA	Square Adjustable
APPEARANCE	
T	Trim
TL	Trimless
REFLECTOR COLOR	
W	White
B	Black

CCT	
27K	2700K
30K	3000K
35K	3500K
40K	4000K
WD18/27K	Warm Dim 1800K to 2700K
WD18/30K	Warm Dim 1800K to 3000K
BEAM ANGLE	
15	15°
25	25°
35	35°
50	50°
WARRANTY	
5	5 Year Warranty (included)
10	10 Year Warranty

Micro Flange

CUT: 60mm

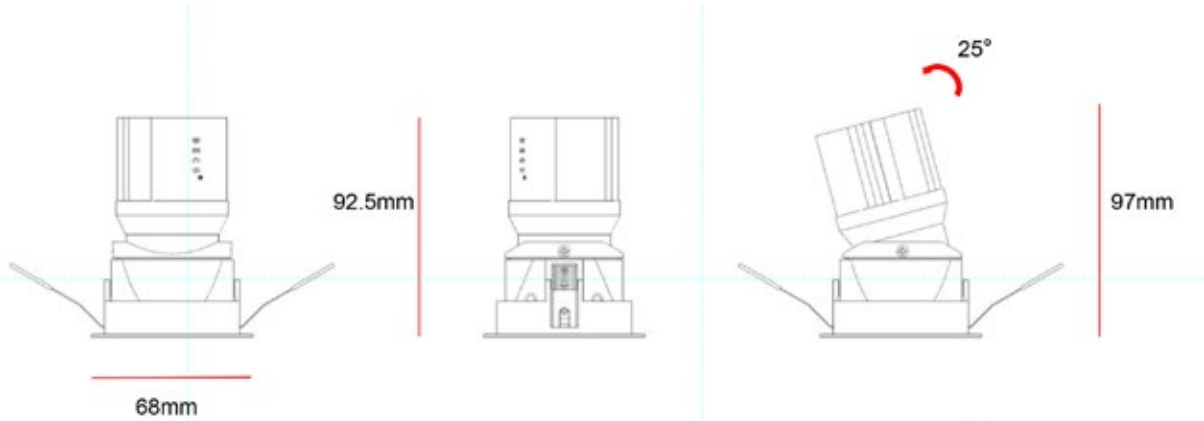

Flangeless

CUT: 60mm

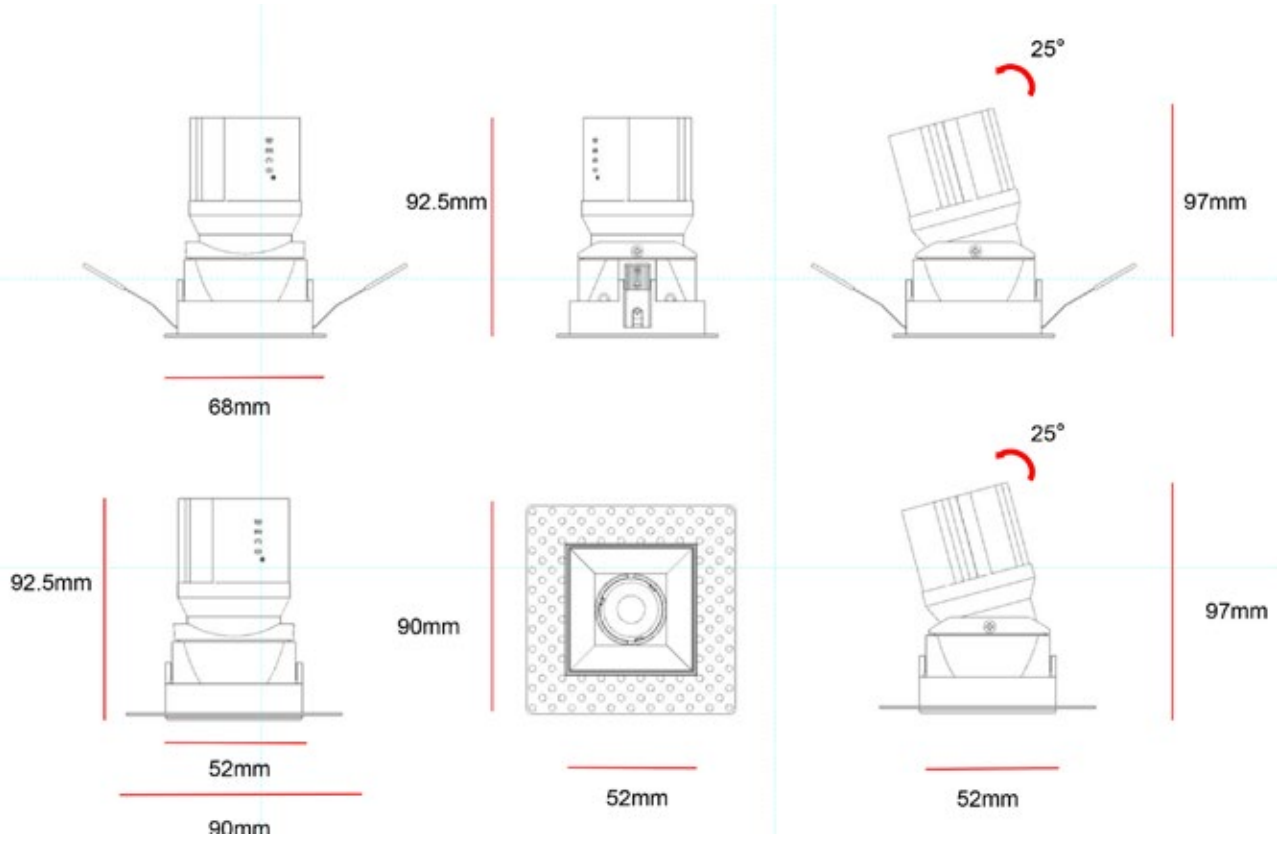

Accessories

Drivers in Junction Box

CMEM55-XX
 TRIAC 6W, 8W, 10W, 15W
 XX = *Must specify wattage*

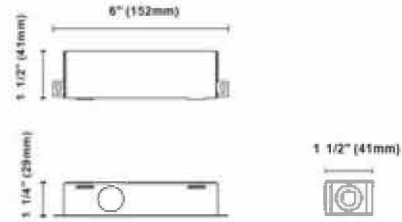

KIG-020-WDJ
 Triac/0-10V/1-10V LED DRIVER 10w/15w/17w/18w/20w 120-277V
 [250mA, 350mA, 400mA, 450mA, 500mA, 600mA, 700mA]

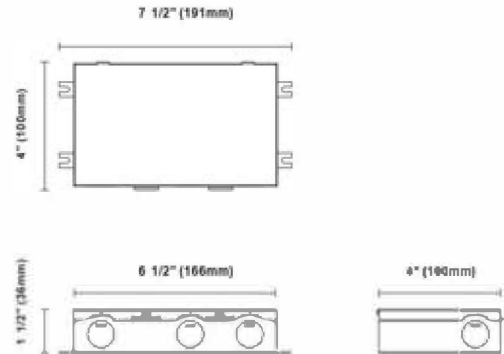

Brackets for New-Construction

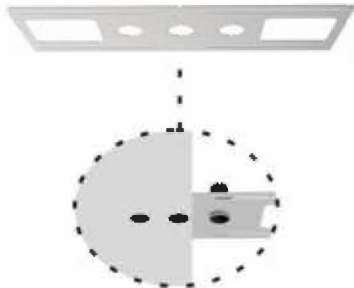

BRKT-3R45A

For Artemis trim & trimless
 Type: New construction plate

Cut out:

Round: Ø1" * 3 (Ø50mm)

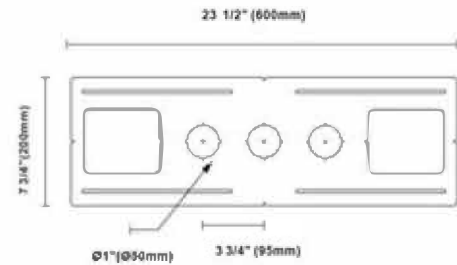

Remark

- Tailored brackets are available with a reasonable surcharge, details as below,
- The customized brackets' dimensions are still the same as the existing ones, 600*200mm
 - Hole sizes can be customized within the range of 25-100mm
 - Holes quantity can be indicated, 1-7pcs
 - Holes' positions on the bracket can be done as requests

Brackets for New-Construction (4-legs)

NCP-SR3-R21-XXX
 xxx = *must specify wattage*



Cut out:
 Round: Ø3" (Ø77mm)
 Ø2" (Ø62mm)
 Ø1" (Ø50mm)
 Square: □3" (□77mm)

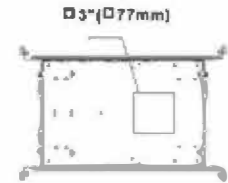
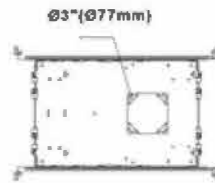
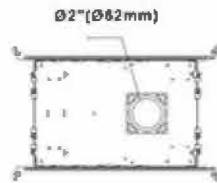
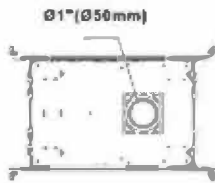
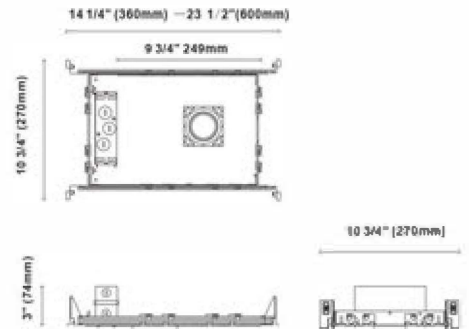

IC-Box for New-Construction (4-legs)

NCBX-SR3-R21-XXX
 xxx = *must specify wattage*



Cut out:
 Round: Ø3" (Ø77mm)
 Ø2" (Ø62mm)
 Ø1" (Ø50mm)
 Square: □3" (□77mm)

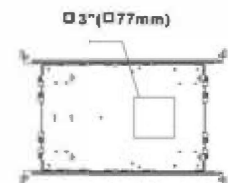
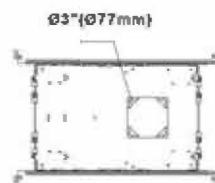
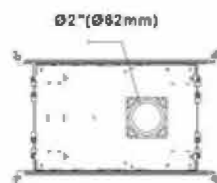
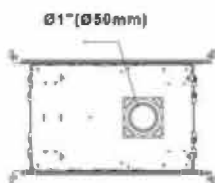
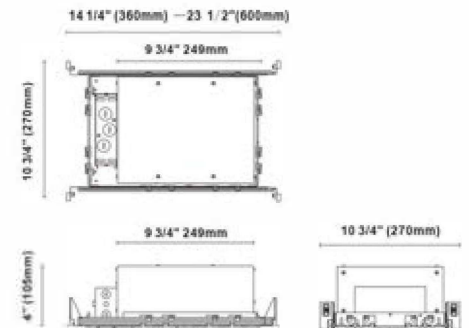

NON-IC Wire Diagram

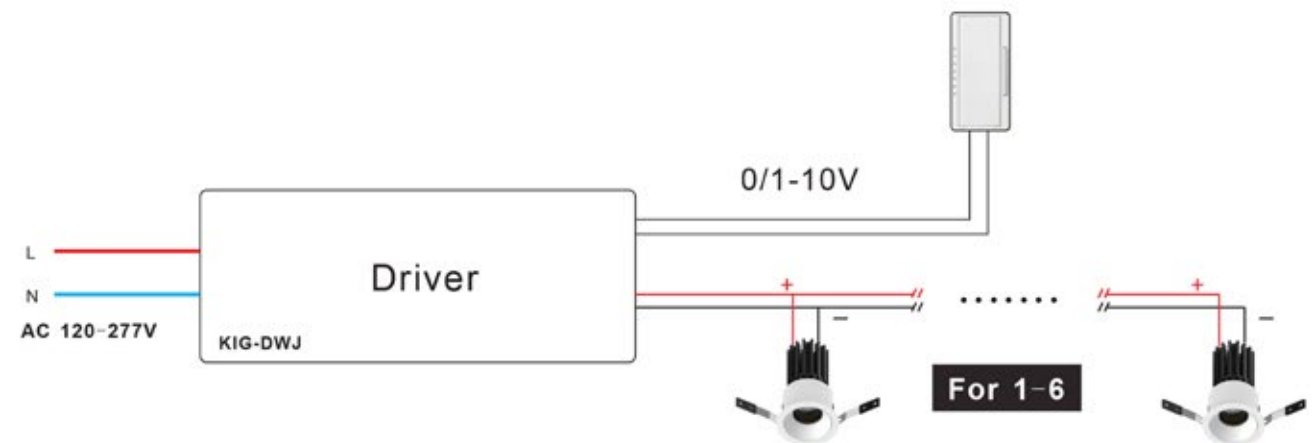
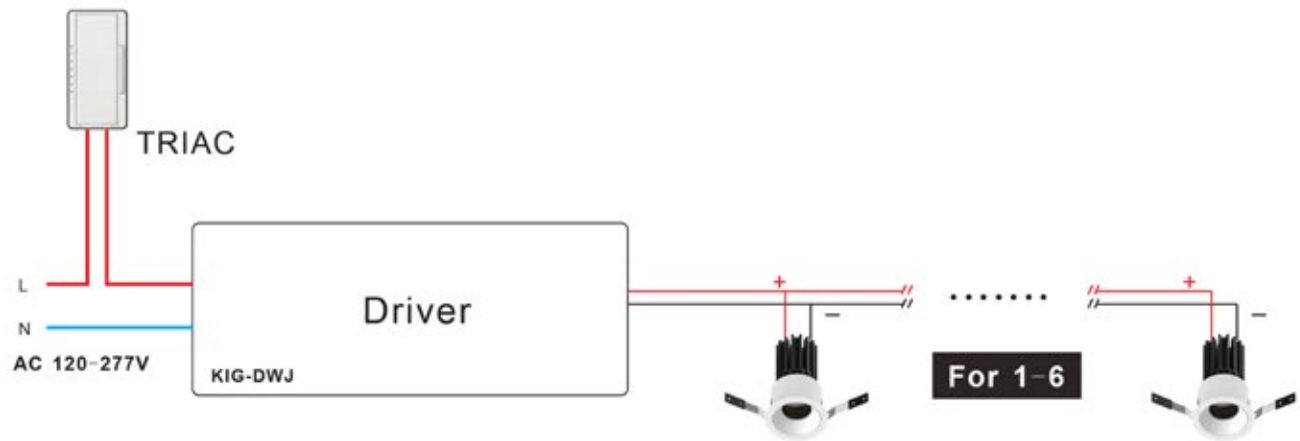
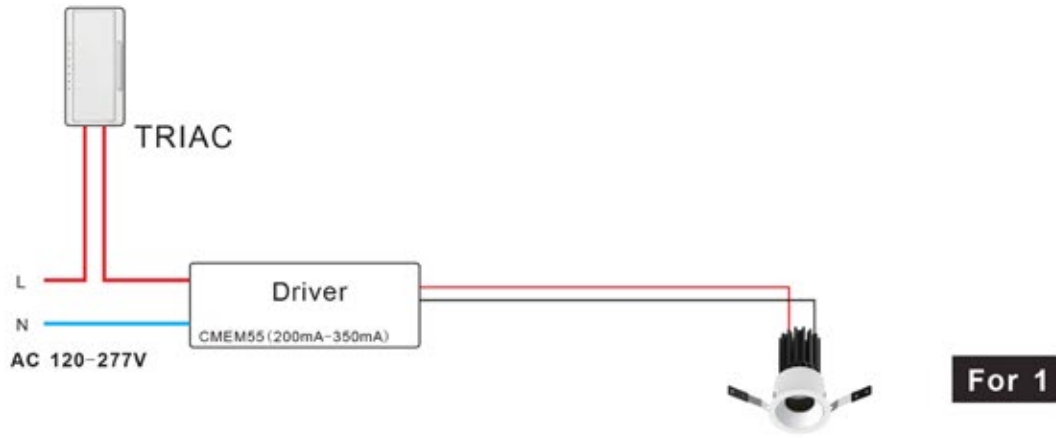

IC Rated Wire Diagram

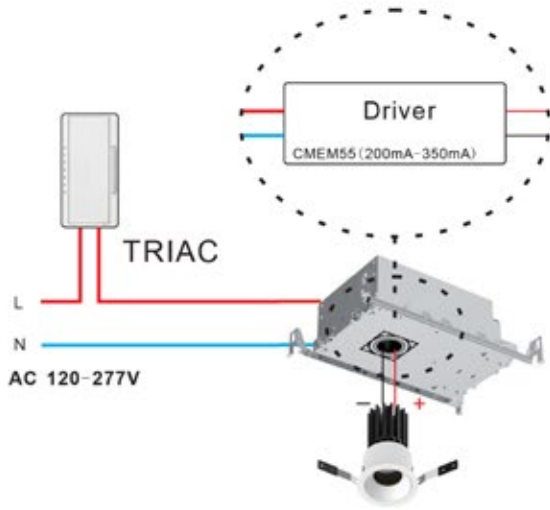

For 1

